

WiFi2 click schematic v100

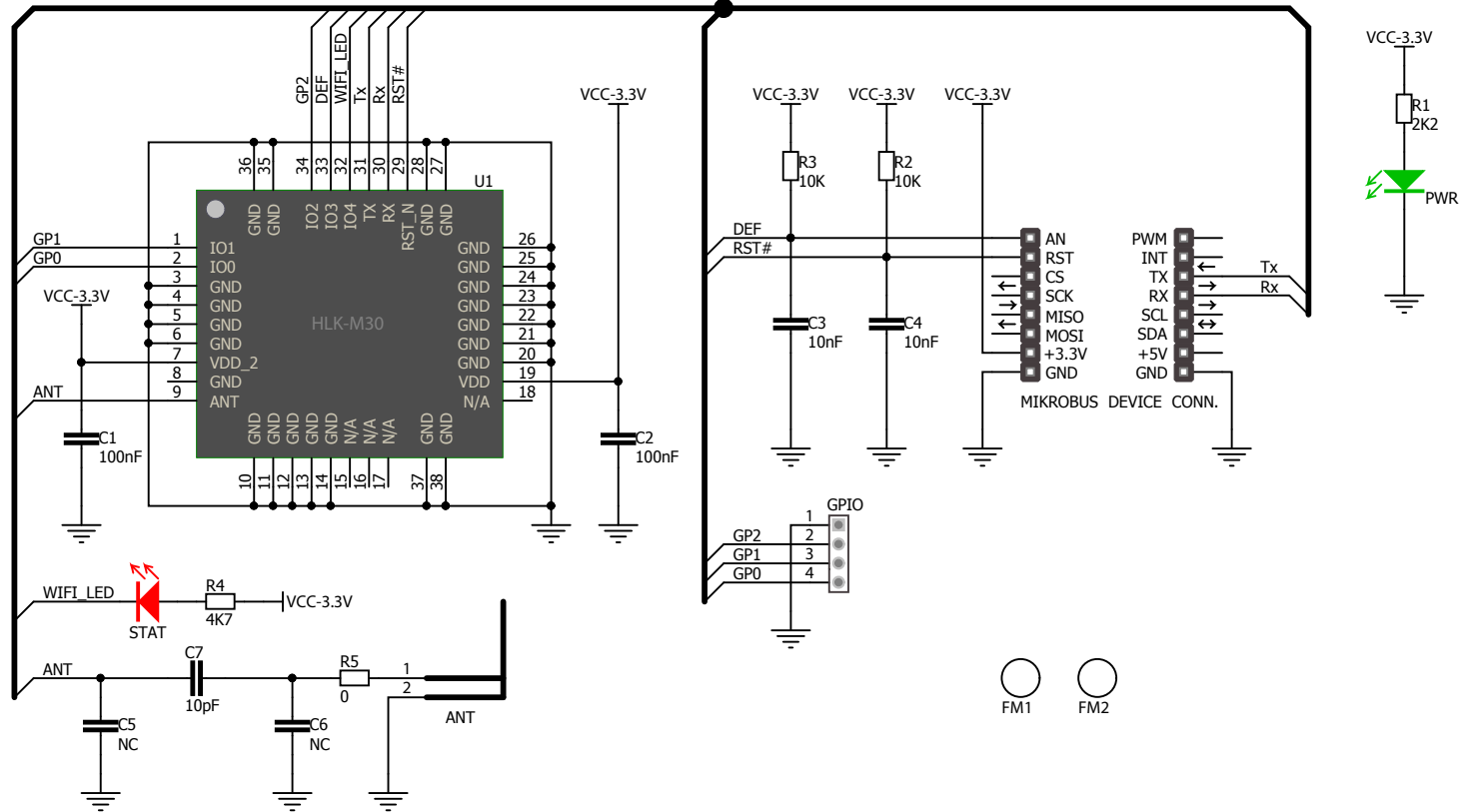

www.mikroe.com