

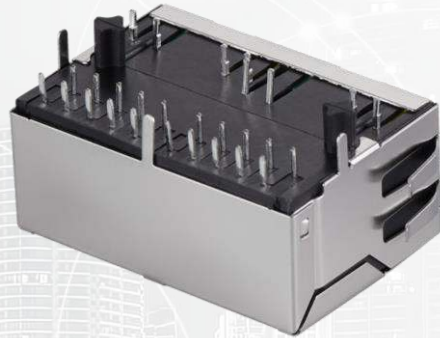

TAOGLAS®



Datasheet

RJ45 ICM 1G Base-T Dual Port

Part No:
TMJG26945AENL

Description:

RJ45 connector with integrated magnetics 1G Base-T
Dual Ports Tab-DOWN with right angle THT mount and LEDs

Features:

EMI Finger
Industrial grade
Short Body
RoHS & REACH Compliant

1. Introduction	3
2. Specifications	4
3. Mechanical	5
4. Electrical	6
5. Packaging & Storage	7
<hr/>	
Changelog	8

Taoglas makes no warranties based on the accuracy or completeness of the contents of this document and reserves the right to make changes to specifications and product descriptions at any time without notice. Taoglas reserves all rights to this document and the information contained herein. Reproduction, use or disclosure to third parties without express permission is strictly prohibited.



1. Introduction



Featuring a popular footprint and compatible package to industry RJ45 Integrated Connectors standards, the Taoglas TMJG26945AENL is an RJ45 Integrated Connector 1G Base-T Dual Port Tab Down with EMI Finger and with shielded short body design that offers extra space.

Typical Applications Include:

- Industrial Automation
- Hubs
- Routers
- Switches
- Wireless Access Points

Taoglas Magnetics offer an extensive product line of RJ45 Integrated Connectors designed for commercial and industrial grade applications, supporting 10/100 Base-T (Atmos100 Series) and 1G Base-T (Atmos1000 series). These surface mount or through-hole components provide reliable performance and maintain signal integrity that meets IEEE 802.3 standards, and they are UL certified. The Power over Ethernet options are also available including PoE, PoE+ and PoE++.

The majority of Taoglas RJ45 ICMs are manufactured with fully automated winding, assembly & testing to ensure consistent performance, quality and reliability while ensuring cost competitiveness for its customers. These products are fully compliant with the REACH and RoHS directive, and compatible with all major PHY vendors.

For customized products or support with integration, contact your regional Taoglas customer support team for further information.

2. Specifications

Electrical Performance @25°C	
Inductance OCL	350µH MIN @ 100KHz 0.1V 8mA DC Bias
Turns Ratio (±5%)	TX=1CT: 1CT RX=1CT: 1CT
Insertion Loss	-1.0dB MAX @ 1-100Mhz
	-1.2dB MAX @ 100-125Mhz
Return Loss	-16dB MIN @ 1-40Mhz
	-12dB MIN @ 40-60Mhz
	-10dB MIN @ 60-80Mhz
	-8dB MIN @ 80-100Mhz
Cross talk	-30dB MIN @ 1-30Mhz
Common Mode Rejection	-30dB MIN @ 1-100Mhz
Hi-Pot	1500Vrms

Environmental Specifications	
Operating Temperature	-40°C TO +85°C

Material Specifications	
Housing	Thermoplastic PBT+30%G. F UL94V-0
Contact	Phosphor Bronze C5210R-EH Thickness = 0.35mm
Contact Plating	Gold Thickness = 6µ" min.
Pins	Brass C2680R-H Thickness = 0.35mm
Shield	Stainless Steel SUS 201-1-1/2H Thickness = 0.2mm

Compliance	
UL recognized - FILE NO. E528697	
RoHS Compliant	

Storage requirements	
Humidity	Storage Temperature
MSL - 1	-40°C TO +85°C

3. Mechanical

3.1 Mechanical Drawings

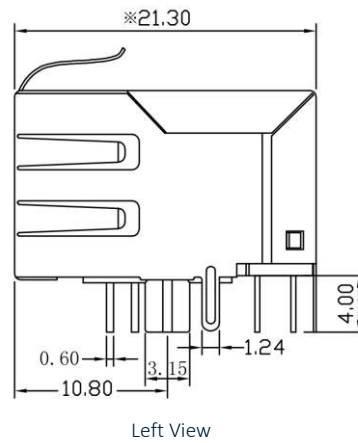
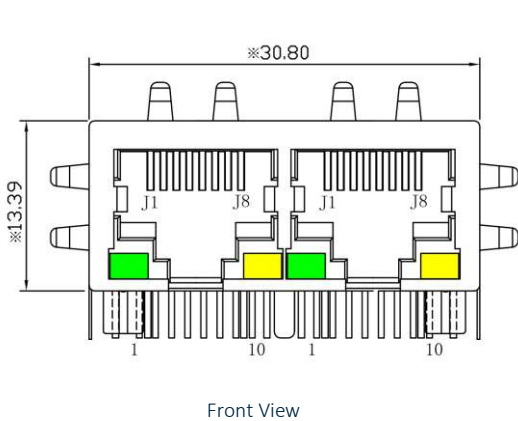

Mechanical Specifications	
Height Above Board	0.527" (13.39mm)
Width	1.213" (30.8mm)
Depth	0.838" (21.3mm)
Mounting Style	Through Hole (THT)
Mounting Angle	Right Angle

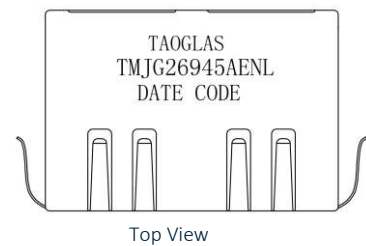

Dimensions are in millimeters with the following tolerances: X.XX = ± 0.25

3.2 PCB Layout

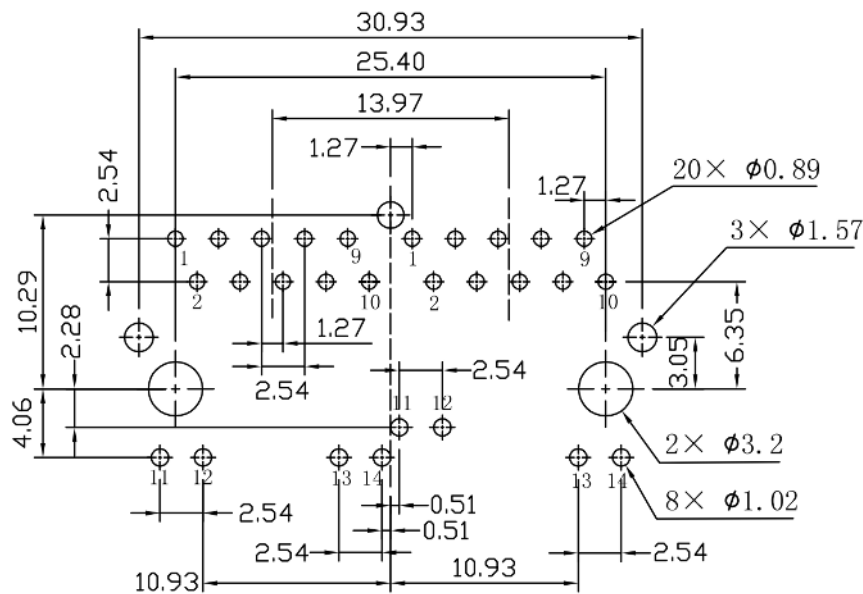

Dimensions are in millimeters with the following tolerances: X.XX = ± 0.10

4. Electrical

4.1 Electrical Drawings

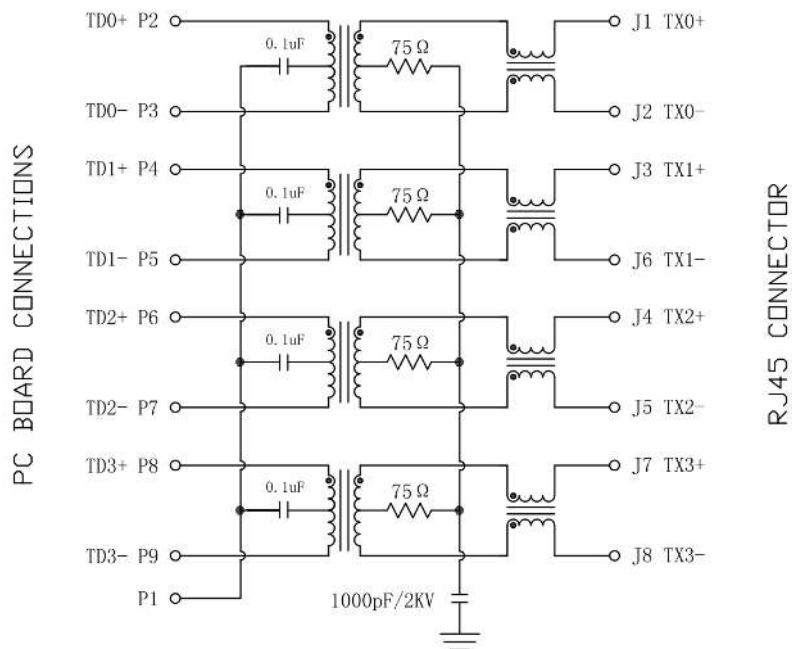

LED Electrical Specification

Standard LED	Wavelength (nm)	V_F ($I_F=20mA$)	I_R ($V_R=5v$)
Green	565	1.8~2.6v	10 μA Max
Yellow	585	1.8~2.6v	10 μA Max

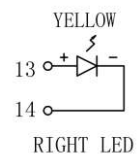
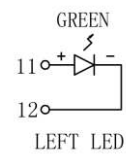

4.2 Profile of Wave Solder

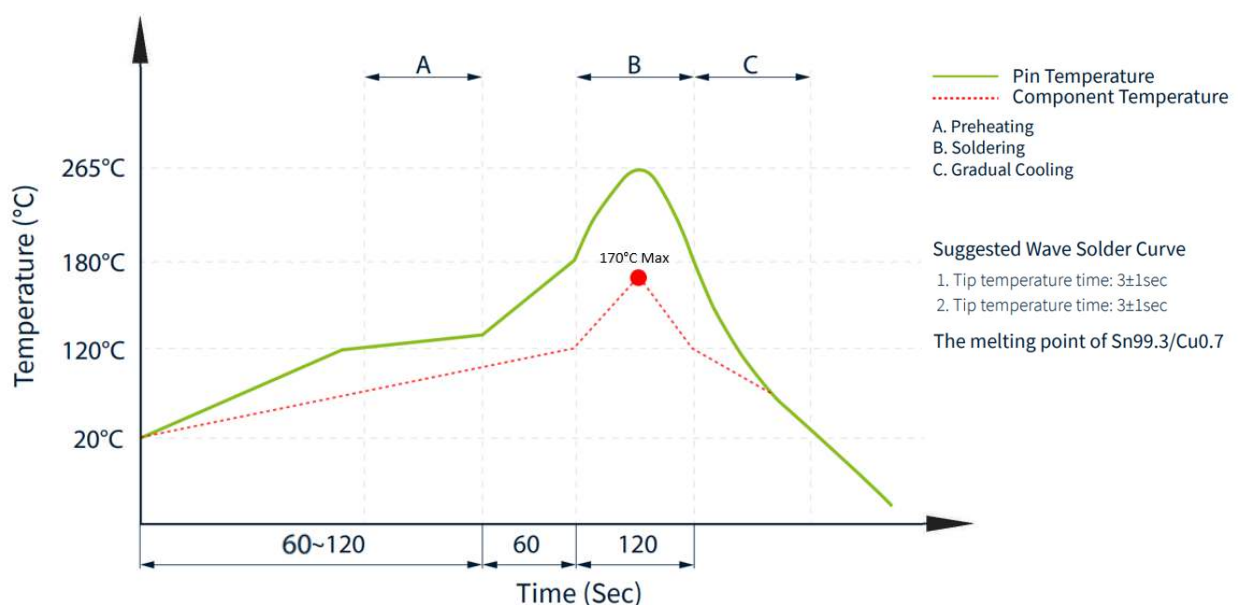

5. Packaging and Storage

5.1 SPQ

30 pcs/tray

Tray dimension: 295*177*23 mm

Tray Weight: 452g

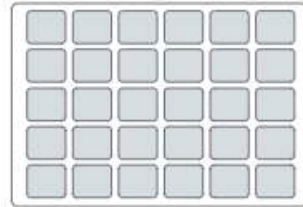

1 CTN = 20 trays = 600 pcs

Carton dimensions: 370*300*300mm

Carton Weight: 10kg

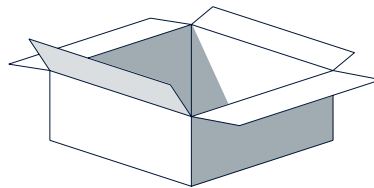

Changelog

Changelog for the datasheet

SPE-22-8-043 – TMJG26945AENL

Revision: A (Original First Release)

Date:	2022-11-08
Notes:	
Author:	Javier Vasena

Previous Revisions



www.taoglas.com

