



# APPLICATION SPECIFICATION

## 1.20MM PITCH, W-T-B, 1.40MM HEIGHT PLUG AND RECEPTACLE CONNECTOR

### 1.0 SCOPE

#### 1.1 CONTENT

This application specification covers the application requirements for 1.20mm Pitch, W-T-B connector.

#### APPLICABLE DOCUMENTS

RSD-78171-001	1.20MM W T B, 1.4MM HT. PLUG CONNECTOR
SD-78171-008	1.20MM W T B, 1.4MM HT. PLUG CONNECTOR
RSD-78172-001	1.20MM W T B, 1.4MM HT. RECEPTACLE
RSD-78172-002	1.20MM W T B, RECEPTACLE (TERMINAL)
SD-78172-007	1.20MM W T B, 1.4MM HT. RECEPTACLE
SD-78172-008	1.20MM W T B, RECEPTACLE (TERMINAL)
RCS-78172-003	1.20MM W T B, Crimp terminal
CS-78172-0012	1.20MM W T B, Crimp terminal

### 2.0 NOMENCLATURE

- 2.1 1.20MM PITCH, W-T-B, 1.4MM HEIGHT CONNECTOR  
78171 (PLUG) / 78172 (RECEPTACLE)

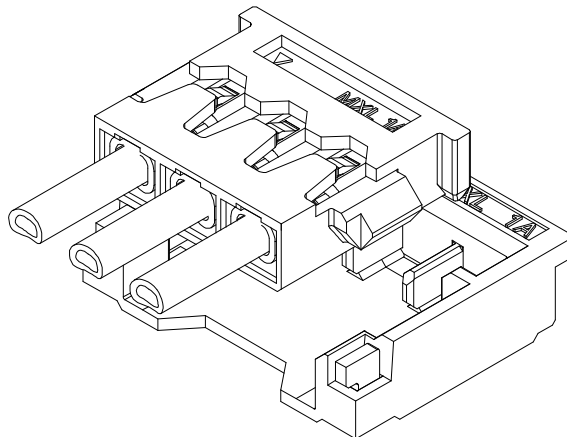

**TENTATIVE RELEASE:** THIS SPECIFICATION IS BASED ON DESIGN OBJECTIVES AND IS STRICTLY TENTATIVE. PRELIMINARY TEST DATA MAY EXIST, BUT THIS SPECIFICATION IS SUBJECTED TO CHANGE BASED ON THE RESULTS OF ADDITIONAL TESTING AND EVALUATION.

REVISION: <b>1</b>	ECR/ECN INFORMATION: EC No: <b>S2008-0098</b> DATE: <b>2007/08/10</b>	TITLE: <b>Application Specification 1.20mm Pitch, W-T-B connector Assembly</b>	SHEET No. <b>1 of 12</b>
DOCUMENT NUMBER: <b>AS-78172-007</b>	CREATED / REVISED BY: <b>CWLAM 2007/12/06</b>	CHECKED BY: <b>KSSHANTHA 2007/12/14</b>	APPROVED BY: <b>NAGESHKN 2007/12/14</b>



# APPLICATION SPECIFICATION

## 3.0 CONNECTOR HANDLING CRITERIA

### 3.1 Mating process method

Align plug on top of receptacle as per datum shown in fig.1. Press down the plug at highlighted area toward the receptacle to mate the connectors.

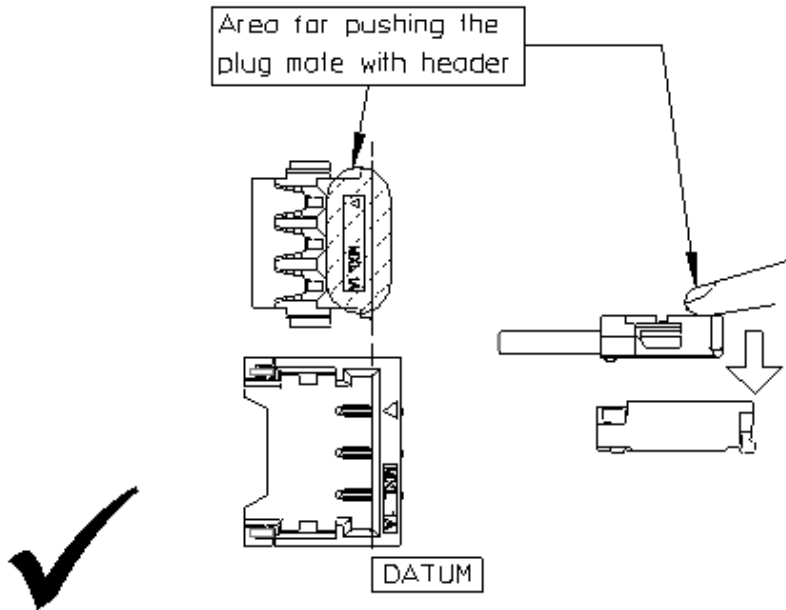
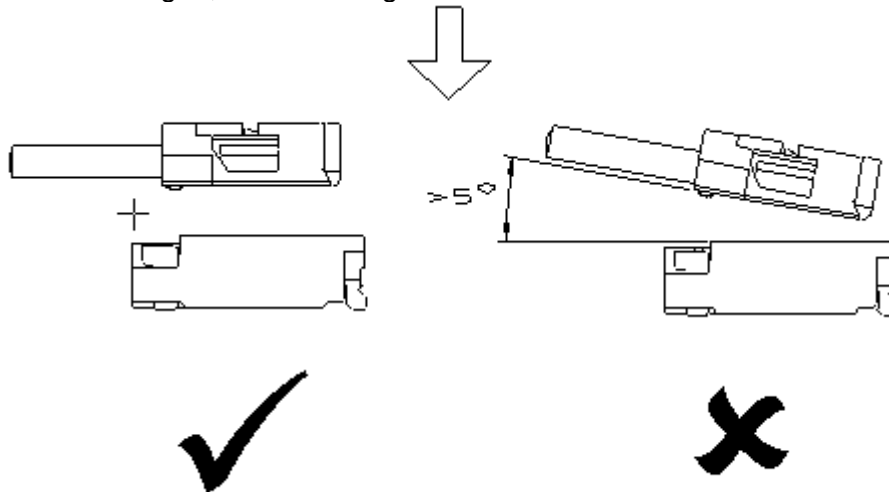

FIG. 1

3.1.1 During mating process, If incase the plug is angle mated towards the straight part of mating entrance as in fig. 2, the allow angle must not exceed 5°.



REVISION: <b>1</b>	ECR/ECN INFORMATION: EC No: <b>S2008-0098</b> DATE: <b>2007/08/10</b>	TITLE: <b>Application Specification 1.20mm Pitch, W-T-B connector Assembly</b>	SHEET No. <b>2 of 12</b>
DOCUMENT NUMBER: <b>AS-78172-007</b>	CREATED / REVISED BY: <b>CWLAM 2007/12/06</b>	CHECKED BY: <b>KSSHANTHA 2007/12/14</b>	APPROVED BY: <b>NAGESHKN 2007/12/14</b>

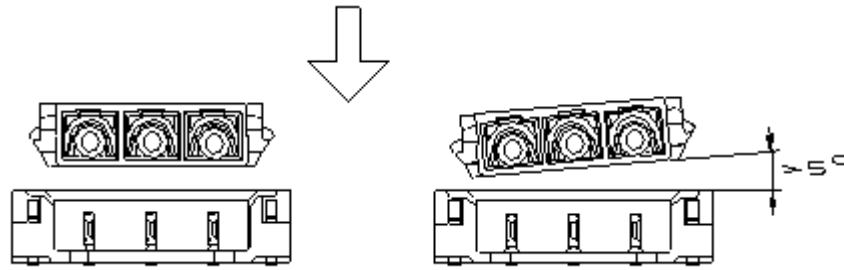

FIG. 2



3.1.2 When connector is fully mated, as shown in fig. 3.1, check for any incomplete mating which will cause damaged contacts as shown in fig. 3.2

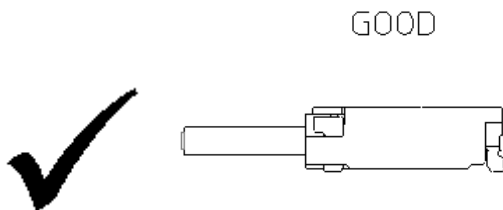

FIG. 3.1

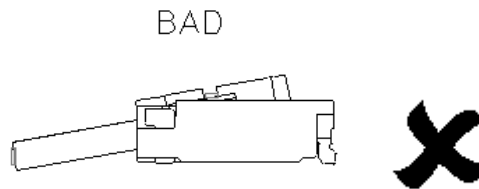

FIG 3.2

REVISION: <b>1</b>	ECR/ECN INFORMATION: EC No: <b>S2008-0098</b> DATE: <b>2007/08/10</b>	TITLE: <b>Application Specification 1.20mm Pitch, W-T-B connector Assembly</b>	SHEET No. <b>3 of 12</b>
DOCUMENT NUMBER: <b>AS-78172-007</b>	CREATED / REVISED BY: <b>CWLAM 2007/12/06</b>	CHECKED BY: <b>KSSHANTHA 2007/12/14</b>	APPROVED BY: <b>NAGESHKN 2007/12/14</b>



# APPLICATION SPECIFICATION

### 3.2 Connector unmating method

Hold gently on plug wires and pull up to unmate the connector as per fig. 4 shown.

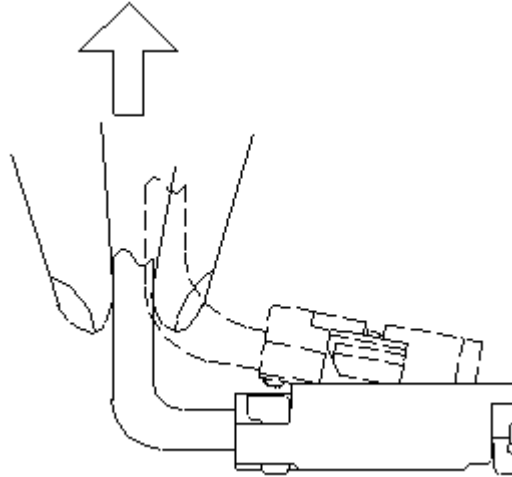

FIG. 4

3.2.1 For unmating process, plug wires pull and stress angle must be maintained within 15° as per fig.5 shown.

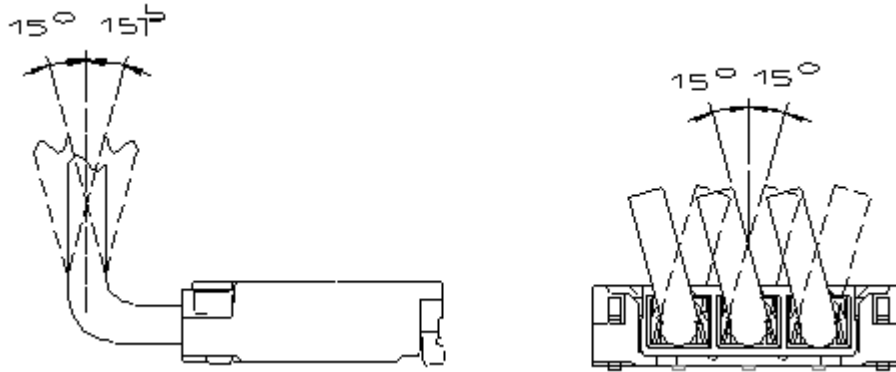

FIG. 5

REVISION: <b>1</b>	ECR/ECN INFORMATION: EC No: <b>S2008-0098</b> DATE: <b>2007/08/10</b>	TITLE: <b>Application Specification 1.20mm Pitch, W-T-B connector Assembly</b>	SHEET No. <b>4 of 12</b>
DOCUMENT NUMBER: <b>AS-78172-007</b>	CREATED / REVISED BY: <b>CWLAM 2007/12/06</b>	CHECKED BY: <b>KSSHANTHA 2007/12/14</b>	APPROVED BY: <b>NAGESHKN 2007/12/14</b>



# APPLICATION SPECIFICATION

3.2.2 Connector shall not be unmated horizontally as shown in fig. 6 to prevent part damage

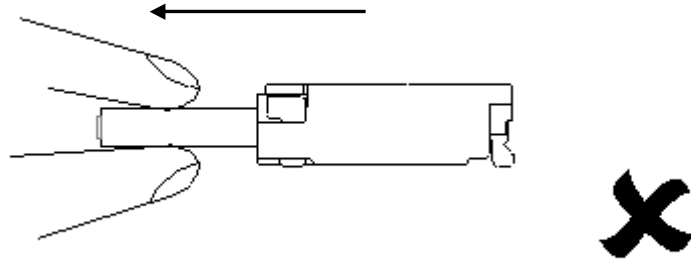

FIG. 6

### 3.3 Application consideration

3.3.1 Make certain the areas & space where the connector placed are clear and sufficient to prevent over stress on plug wires as example shown in fig. 7.

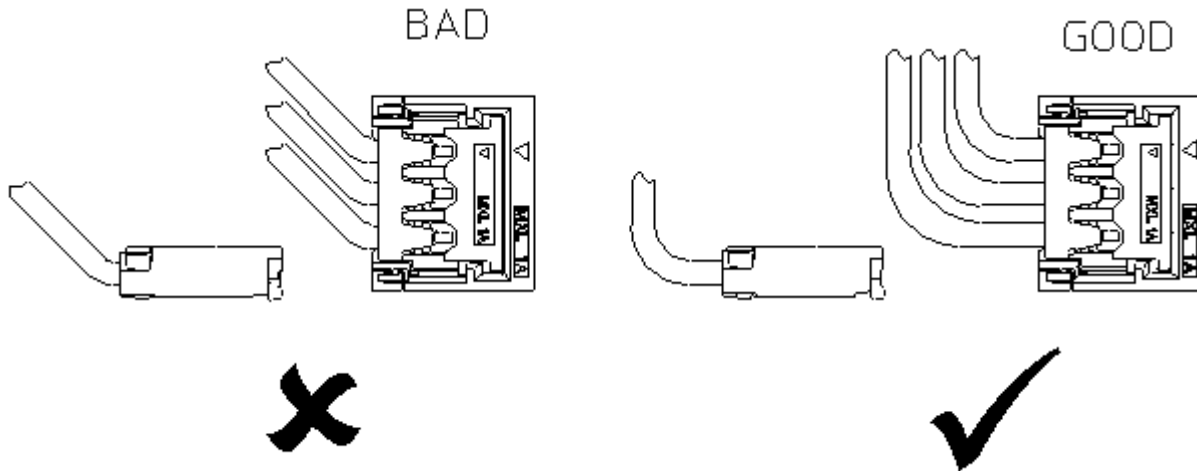

FIG. 7

REVISION: <b>1</b>	ECR/ECN INFORMATION: EC No: <b>S2008-0098</b> DATE: <b>2007/08/10</b>	TITLE: <b>Application Specification 1.20mm Pitch, W-T-B connector Assembly</b>	SHEET No. <b>5 of 12</b>
DOCUMENT NUMBER: <b>AS-78172-007</b>	CREATED / REVISED BY: <b>CWLAM 2007/12/06</b>	CHECKED BY: <b>KSSHANTHA 2007/12/14</b>	APPROVED BY: <b>NAGESHKN 2007/12/14</b>

## 4.0 ANATOMY OF A CRIMP TERMINATION

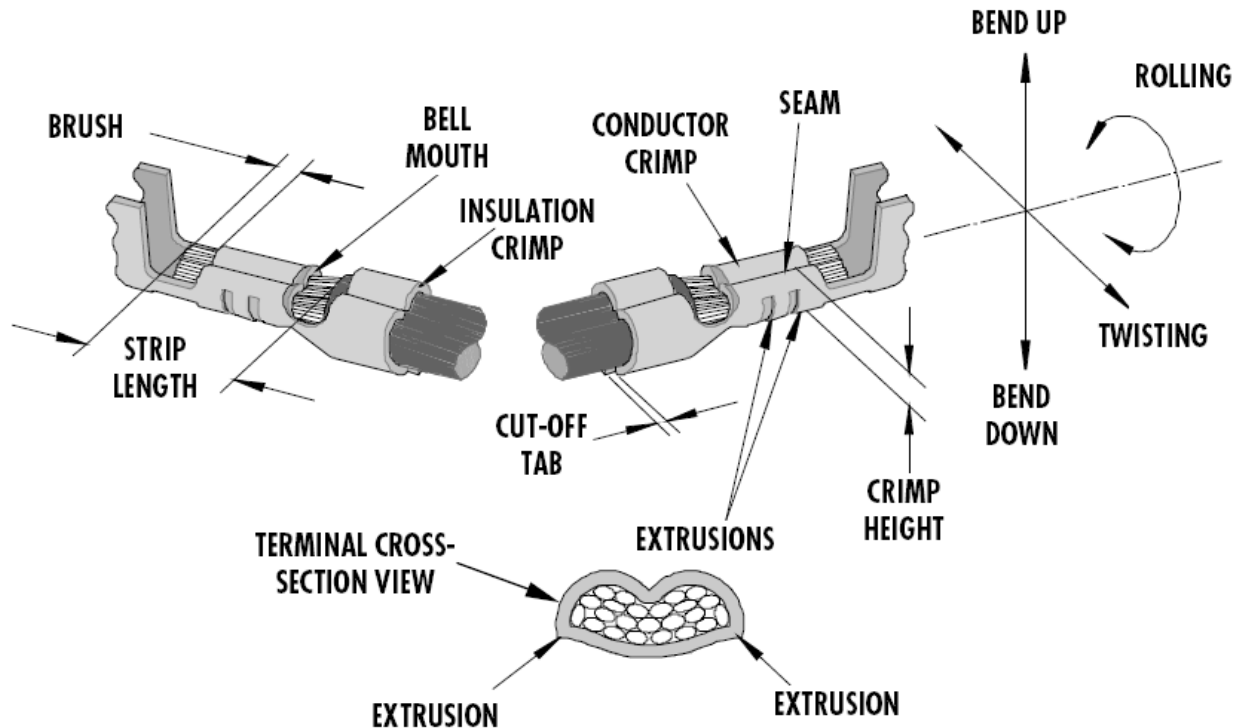

FIG. 8

### 4.1 Definition ( FIG. 8)

#### 4.1.1 Bell Mounth (Flare)

- The flare that is formed on the edge of the conductor crimp acts as a funnel for the wire strands. This funnel reduces the possibility that a sharp edge on the conductor crimp will cut or nick the wire strand.

#### 4.1.2 Conductor Brush

- The conductor brush is made up of the wire strands that extend past the conductor crimp on the contact side of the terminal. This help ensure that mechanical compression occurs over the full length of the conductor crimp. The conductor brush should not extend into the contact area.

#### 4.1.3 Conductor Crimp

- This is the metallurgical compression of a terminal around the wire's conductor. This connection creates a common electrical path with low resistance and high current carrying capabilities.

REVISION: <b>1</b>	ECR/ECN INFORMATION: EC No: <b>S2008-0098</b> DATE: <b>2007/08/10</b>	TITLE: <b>Application Specification 1.20mm Pitch, W-T-B connector Assembly</b>	SHEET No. <b>6 of 12</b>
DOCUMENT NUMBER: <b>AS-78172-007</b>	CREATED / REVISED BY: <b>CWLAM 2007/12/06</b>	CHECKED BY: <b>KSSHANTHA 2007/12/14</b>	APPROVED BY: <b>NAGESHKN 2007/12/14</b>



# APPLICATION SPECIFICATION

## 4.1.4 Conductor Crimp Height

- The conductor crimp height is measured from the top surface of the formed crimp to the bottom radial surface. Do not include the extrusion points in this measurement. (see fig. 8). Measuring crimp height is a quick, non-destructive way to help ensure the correct metallurgical compression of a terminal around the wire's conductor and is an excellent attribute for process control.

## 4.1.5 Extrusions

- These are the small flares that form on the bottom of the conductor crimp resulting from the clearance between the punch and anvil tooling. If the anvil is worn or the terminal is over-crimped, excessive extrusion are the result. An uneven extrusion may also result if the punch and anvil alignment is not correct, if the feed adjustment is off or if there is insufficient/excessive terminal drag.

## 4.1.6 Insulation Crimp (strain Relief)

- This is the part of the terminal that provides both wire support for insertion into the housing and allows the terminal to withstand shock & vibration. The terminal needs to hold the wire as firmly as possible without cutting through to the conductor strands.

## 5.0 GOOD CRIMPING INTRODUCTION

5.1 An example of a properly performed crimp is seen below ( Fig.9) :

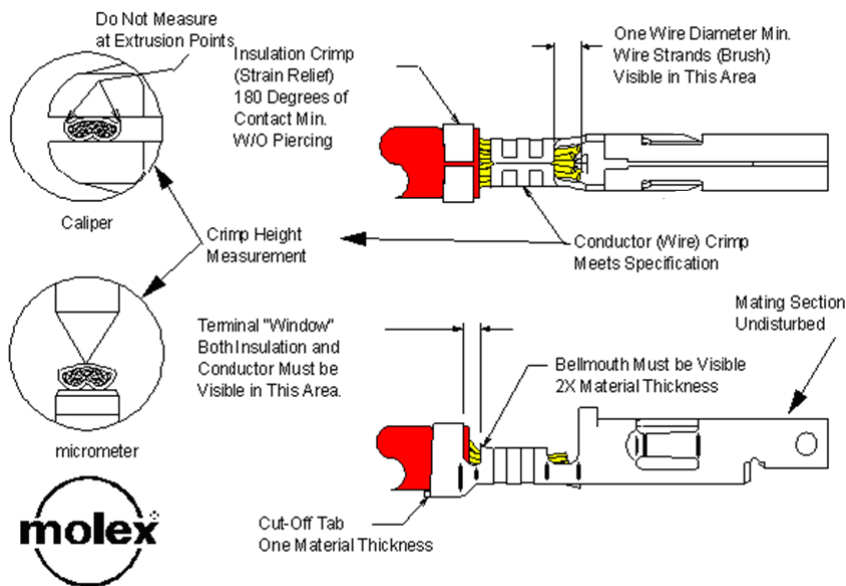

FIG. 9

In the picture above, the insulation crimp compresses the insulation without piercing. The wire strands (or brush) protrude through the front of the conductor crimp section by at least the diameter of the wire's conductor. Both the insulation and conductor are visible in the area between the insulation and the conductor crimp section. The conductor crimp section shows a bellmouth shape in the leading and trailing ends, while the transition and mating sections remain exactly the same as they were before the crimping process.

REVISION: <b>1</b>	ECR/ECN INFORMATION: EC No: <b>S2008-0098</b> DATE: <b>2007/08/10</b>	TITLE: <b>Application Specification 1.20mm Pitch, W-T-B connector Assembly</b>	SHEET No. <b>7 of 12</b>
DOCUMENT NUMBER: <b>AS-78172-007</b>	CREATED / REVISED BY: <b>CWLAM 2007/12/06</b>	CHECKED BY: <b>KSSHANTHA 2007/12/14</b>	APPROVED BY: <b>NAGESHKN 2007/12/14</b>



# APPLICATION SPECIFICATION

## 5.2 Crimp conditions

### 5.2.1 Crimp Height is too small (fig.10)

- The crimp height, which is the cross sectional height of the conductor crimp section after it has been crimped, is the most important characteristic of a good crimp.
- A crimp height that is either too small or too large will not provide the specified crimp strength (terminal retention to the wire), will reduce the wire pull out force and current rating, and may generally cause the crimp to under perform in otherwise normal operating conditions.
- A crimp height that is too small also may cut strands of the wire or fracture the metal of the conductor crimp section.

Crimp Height Too Small Per Terminal/Wire Specification

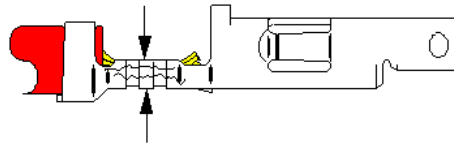

Crimp Height Meets Terminal's Specification for Wire AWG

Good Crimp

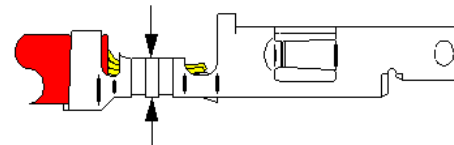

Solution: Verify Correct Terminal for AWG or  
Adjust Conductor Crimp Height on Press

**FIG. 10**

### 5.2.2 Crimp Height is too large (fig.11)

- A crimp height that is too large will not compress the wire strands properly, causing excessive voids in the crimp section because there is not enough metal-to-metal contact between the wire strands and the metal of the terminal.

Crimp Height Too Large Per Terminal/Wire Specification

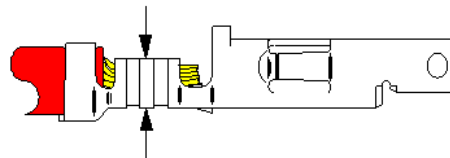

Crimp Height Meets Terminal's Specification for Wire AWG

Good Crimp

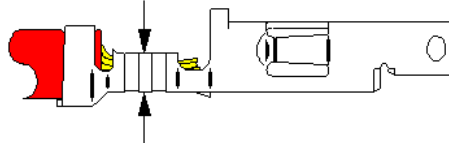

Solution: Verify Correct Terminal for AWG or  
Adjust Conductor Crimp Height on Press

**FIG. 11**

REVISION: <b>1</b>	ECR/ECN INFORMATION: EC No: <b>S2008-0098</b> DATE: <b>2007/08/10</b>	TITLE: <b>Application Specification 1.20mm Pitch, W-T-B connector Assembly</b>	SHEET No. <b>8 of 12</b>
DOCUMENT NUMBER: <b>AS-78172-007</b>	CREATED / REVISED BY: <b>CWLAM 2007/12/06</b>	CHECKED BY: <b>KSSHANTHA 2007/12/14</b>	APPROVED BY: <b>NAGESHKN 2007/12/14</b>





# APPLICATION SPECIFICATION

## 5.2.3 Crimp Width

- Crimp width is just as important as crimp height. For optimum crimp performance, the cross sectional area needs to be controlled. The crimp tool geometry will produce the proper crimp width, when the terminal is crimped to the recommended height.

## 5.2.4 Insulation Crimp Too Small or Too Large. (fig. 12)

- A good crimping terminal allow to grip the insulation for at least 180 degrees without piercing the insulation.

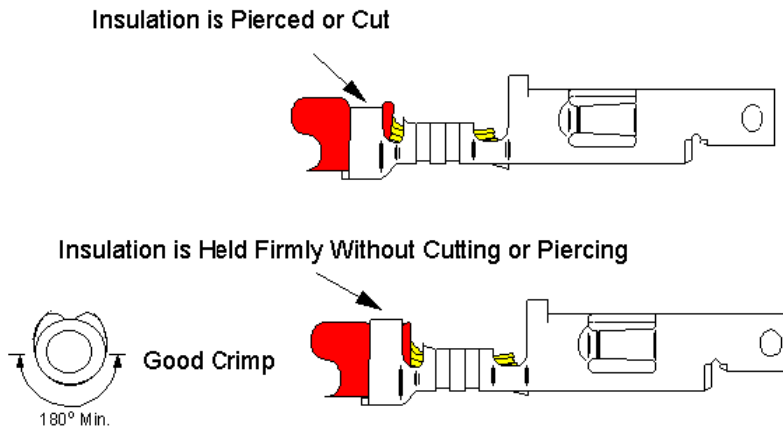

FIG. 12

Solution: Adjust Insulation Crimp Height on Press

## 5.2.5 Loose Wire Strands (fig.13)

- Loose wire strands are another common cause of crimping problems. If all the wire strands are not fully enclosed in the conductor crimp section, both the strength of the crimp and the current carrying capability may be greatly reduced. To get a good crimp you need to meet the crimp height specifications.

All Wire Strands Are Not in Conductor Crimp Section

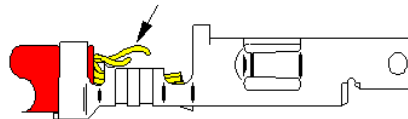

All Strands Fully Collected in Conductor Crimp Section

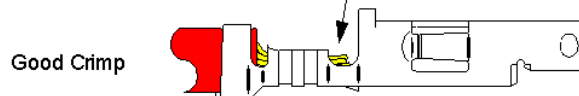

FIG. 13

Solution: Gather Wire Strands Before Presenting to Crimp Die

REVISION: <b>1</b>	ECR/ECN INFORMATION: EC No: <b>S2008-0098</b> DATE: <b>2007/08/10</b>	TITLE: <b>Application Specification 1.20mm Pitch, W-T-B connector Assembly</b>	SHEET No. <b>9 of 12</b>
DOCUMENT NUMBER: <b>AS-78172-007</b>	CREATED / REVISED BY: <b>CWLAM 2007/12/06</b>	CHECKED BY: <b>KSSHANTHA 2007/12/14</b>	APPROVED BY: <b>NAGESHKN 2007/12/14</b>



# APPLICATION SPECIFICATION

## 5.2.6 Too Short Strip Length (fig. 14)

- If the strip length is too short or if a wire is not fully inserted into the conductor Crimp Section, the termination may not meet the specified pull force because the metal-to-metal contact between the wire and the terminal pin is reduced. As shown in the figure above, the strip length of the wire is too short (note that the insulation is in its proper position), not allowing the required one wire outside diameter (OD) extension in front of the conductor Crimp Section.

Wire Does Not Protrude Out of The Conductor Crimp Section

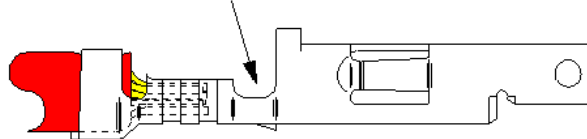

Wire Protrudes Out of Crimp Section by One Wire Diameter Min.

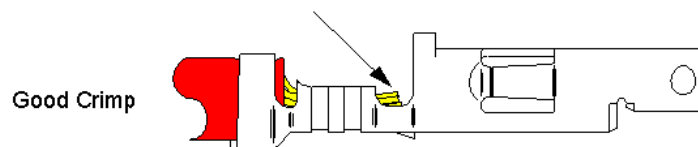

Solution Increase Strip Length or Insert Wire Further Into Crimp Section Before Crimping. Also Watch for Proper Insulation Position.

FIG. 14

## 5.2.7 Wire Inserted Too Far (fig. 15)

- Another crimping problem that relates to a too short strip length occurs when the wire is inserted too far into the crimp sections. As the fig.15 below shows, the insulation is too far forward of the insulation crimp section and the conductors protrude into the transition section. This may cause as many as three failure modes in the actual application. Two relate to a reduced current rating/wire pull out force due to a reduction of the metal-to-metal contact in the conductor crimp section.

- The third failure mode may occur when the connectors are mated. If the wire protrudes so far into the transition section that the tip of the male terminal hits against the wire, it may prevent the connectors from fully seating or it may bend the male or female terminals.

- Under extreme cases, the terminal may be pushed out from the back of the housing even though it was fully seated in the housing.

REVISION: <b>1</b>	ECR/ECN INFORMATION: EC No: <b>S2008-0098</b> DATE: <b>2007/08/10</b>	TITLE: <b>Application Specification 1.20mm Pitch, W-T-B connector Assembly</b>	SHEET No. <b>10 of 12</b>
DOCUMENT NUMBER: <b>AS-78172-007</b>	CREATED / REVISED BY: <b>CWLAM 2007/12/06</b>	CHECKED BY: <b>KSSHANTHA 2007/12/14</b>	APPROVED BY: <b>NAGESHKN 2007/12/14</b>



# APPLICATION SPECIFICATION

Wire Conductor Extends Into Transition Section of Terminal and Insulation is Into Crimp Section

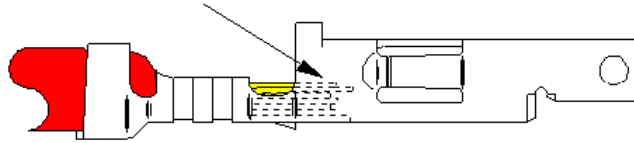

Wire Protrudes Out of Crimp Section by One Wire Diameter Min. and Both Insulation and Conductor Are Visible.

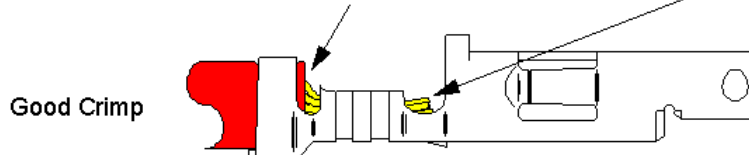

FIG. 15

Solution: Strip Length Too Long or Wire Inserted Too Far Into Crimp Section Before Crimping. Check Wire Stop Location on Press.

## 5.2.8 "Banana" (Excessive Bending) Terminal (fig.16)

- One of the most descriptive crimping problems is known as a "banana" crimp, because the crimped terminal takes on a banana shape. This makes it difficult to insert the terminal into the housing and may cause terminal butting.

Mating Section and Crimp Section Center Lines Not Parallel

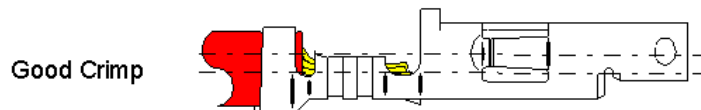
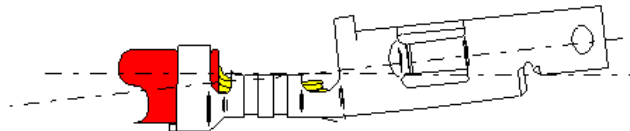

FIG. 16

Solution: Adjust Holddown Pin on Crimp Press

REVISION: <b>1</b>	ECR/ECN INFORMATION: EC No: <b>S2008-0098</b> DATE: <b>2007/08/10</b>	TITLE: <b>Application Specification 1.20mm Pitch, W-T-B connector Assembly</b>	SHEET No. <b>11 of 12</b>
DOCUMENT NUMBER: <b>AS-78172-007</b>	CREATED / REVISED BY: <b>CWLAM 2007/12/06</b>	CHECKED BY: <b>KSSHANTHA 2007/12/14</b>	APPROVED BY: <b>NAGESHKN 2007/12/14</b>



# APPLICATION SPECIFICATION

## 5.2.9 Undersized Bellmouth (fig. 17)

- The correct size for a bellmouth is approximately 2X the thickness of the terminal material. If the bellmouth is missing or if it is less than one material thickness, there is a risk of cutting the wire strands.

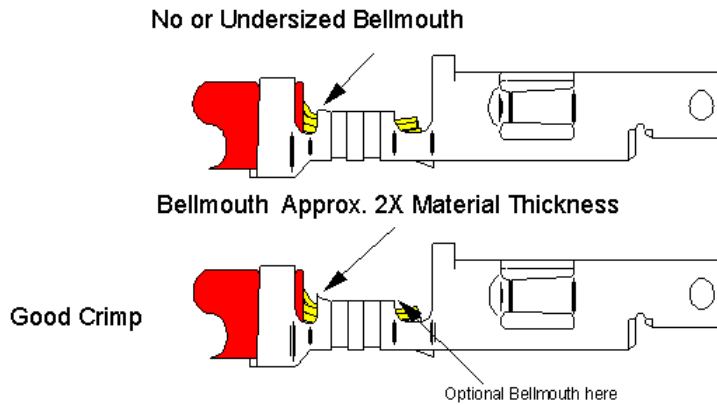

FIG. 17

Solution: Check Tooling Setup/Alignment of Terminal Strip

## 5.2.10 Oversized Bellmouth (fig.18)

- There is also a problem if the bellmouth is oversized, because this reduces the total area that the crimp section of the terminal has in contact with the wire. The less the wire-to-terminal interface, the lower the wire pull out force.

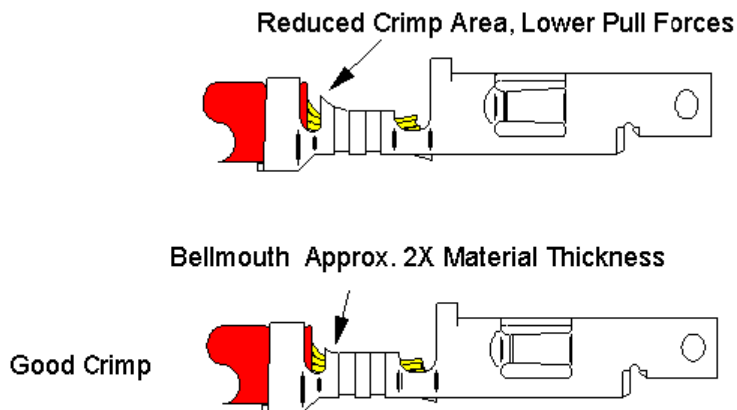

FIG. 18

Solution: Check Tooling Setup/Alignment of Terminal Strip

REVISION: <b>1</b>	ECR/ECN INFORMATION: EC No: <b>S2008-0098</b> DATE: <b>2007/08/10</b>	TITLE: <b>Application Specification 1.20mm Pitch, W-T-B connector Assembly</b>	SHEET No. <b>12 of 12</b>
DOCUMENT NUMBER: <b>AS-78172-007</b>	CREATED / REVISED BY: <b>CWLAM 2007/12/06</b>	CHECKED BY: <b>KSSHANTHA 2007/12/14</b>	APPROVED BY: <b>NAGESHKN 2007/12/14</b>