

# CD22014E

## COS/MOS Quartz Analog Clock Circuit

The RCA-CD22014E\* is a timing circuit consisting of a counter that divides by 65,536, an inverting output buffer, and input inverters for use as a crystal oscillator.

The output has a 50% duty cycle. The input inverter is intended for use as a crystal oscillator/amplifier, but may also be used as a conventional logic inverter. If an external clock is used to drive terminal 7, no connection should be made to terminal 6.

The counter advances on the negative transition of the input pulse. The CD22014E is supplied in the 8-lead dual-in-line plastic (Mini-DIP) package.

\* Formerly RCA Developmental Type TA6817.

### Preliminary Data

#### Features:

- Accurate crystal-oscillator (3.93-MHz) operation
- Nominal 12-V operation
- Low startup voltage — 5 V at 3.93 MHz
- Dynamic power dissipation — 38 mW max. at  $V_{DD} = 10\text{ V}$ ,  $f_{\phi} = 3.93\text{ MHz}$
- High sink and source output currents — 25 mA min. at  $V_{DD} = 10\text{ V}$

#### Applications:

- Automotive clocks, wall clocks, and table clocks with stepping-motor drive
- Digital timing reference
- Frequency divider

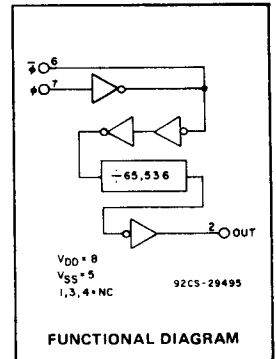

### RECOMMENDED OPERATING CONDITIONS at $T_A = 25^\circ\text{C}$

CHARACTERISTIC	$V_{DD}$ (V)	LIMITS		UNITS
		Min.	Max.	
Supply Voltage	—	3	18	V
Input Pulse Frequency	10	dc	6	MHz
Input Pulse Width	10	100	—	ns
Pulse Rise or Fall Time	10	—	15	$\mu\text{s}$

### MAXIMUM RATINGS, Absolute-Maximum Values:

DC SUPPLY VOLTAGE RANGE ( $V_{DD} - V_{SS}$ )	—0.5 to +18 V
INPUT VOLTAGE RANGE	—0.5 to $V_{DD} + 0.5\text{ V}$
POWER DISSIPATION PER PACKAGE ( $P_D$ ):	
For $T_A = -40$ to $+60^\circ\text{C}$	500 mW
For $T_A = +60$ to $+85^\circ\text{C}$	Derate linearly at $12\text{ mW}/^\circ\text{C}$ to 200 mW
DEVICE DISSIPATION PER OUTPUT TRANSISTOR:	
For $T_A = -40$ to $+25^\circ\text{C}$	500 mW
For $T_A = +25$ to $+85^\circ\text{C}$	Derate linearly at $6.67\text{ mW}/^\circ\text{C}$ to 100 mW
OPERATING TEMPERATURE RANGE ( $T_A$ )	—40 to $+85^\circ\text{C}$
STORAGE-TEMPERATURE RANGE ( $T_A$ )	—65 to $+150^\circ\text{C}$
LEAD TEMPERATURE (During Soldering):	
At distance $1/16 \pm 1/32$ in. ( $1.59 \pm 0.70\text{ mm}$ )	$265^\circ\text{C}$
from case for 10 s max.	

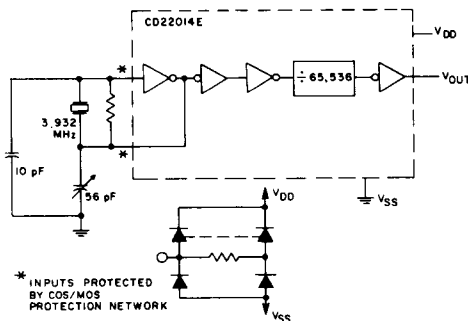

Fig. 3 — Typical oscillator circuit.

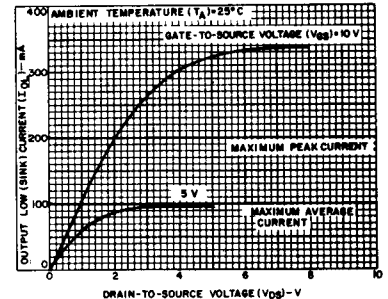

Fig. 1 — Typical output low (sink) current characteristics.

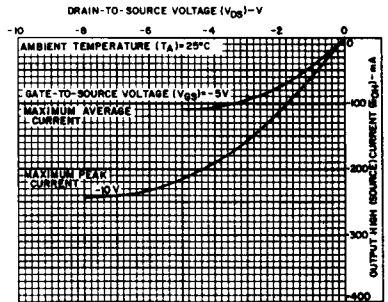

Fig. 2 — Typical output high (source) current characteristics.

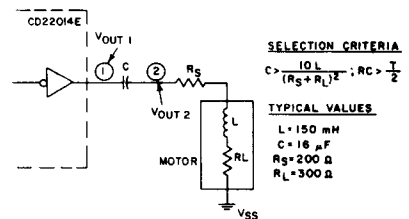

Fig. 4 — Typical output circuit and values.

STATIC ELECTRICAL CHARACTERISTICS at T<sub>A</sub> = 25°C

CHARACTERISTIC	CONDITIONS			LIMITS			UNITS
	V <sub>O</sub> (V)	V <sub>IN</sub> (V)	V <sub>DD</sub> (V)	Min.	Typ.	Max.	
Quiescent Device Current, I <sub>DD</sub>	—	0,5	5	—	0.04	25	μA
	—	0,10	10	—	0.04	50	
Output Low (Sink) Current, I <sub>OL</sub>	0.4	0,5	5	8	25	—	mA
	0.5	0,10	10	25	50	—	
Output High (Source) Current, I <sub>OH</sub>	4.6	0,5	5	-8	-20	—	mA
	9.5	0,10	10	-25	-30	—	
Output Voltage: Low-Level, V <sub>OL</sub>	—	0,5	5	—	0	0.05	V
	—	0,10	10	—	0	0.05	
High-Level, V <sub>OH</sub>	—	0,5	5	4.95	5	—	V
	—	0,10	10	9.95	10	—	
Input Low Voltage, V <sub>IL</sub>	0.5,4.5	—	5	—	—	1.5	V
	1,9	—	10	—	—	3	
Input High Voltage, V <sub>IH</sub>	0.5,4.5	—	5	3.5	—	—	V
	1,9	—	10	7	—	—	
Input Current, I <sub>IN</sub>	—	0,18	18	—	±10 <sup>-5</sup>	±1	μA

DYNAMIC ELECTRICAL CHARACTERISTICS at T<sub>A</sub> = 25°C

CHARACTERISTIC	TEST CONDITIONS	LIMITS			UNITS
		V <sub>DD</sub> (V)	Typ.	Max.	
Operating Current *	f = 3.932 MHz	10	1.3	3.8	mA
Oscillator Starting Voltage *	f = 3.932 MHz	—	3.4	4.5	V
Input Capacitance		—	5	—	pF

\*In circuit of Fig. 3 with output open.

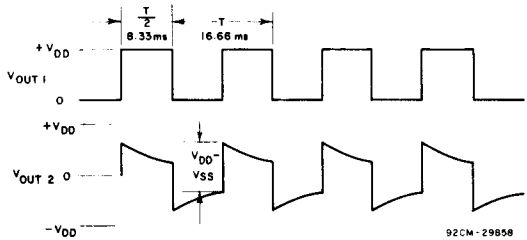
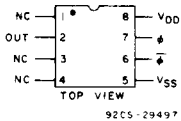

Fig. 5 – Output waveforms for the circuit of Fig. 4 with an oscillator frequency of 3.932 MHz.



TERMINAL ASSIGNMENT