

SHOWN WITH PROTECTIVE CAP

LONG PULL TAB TYPE

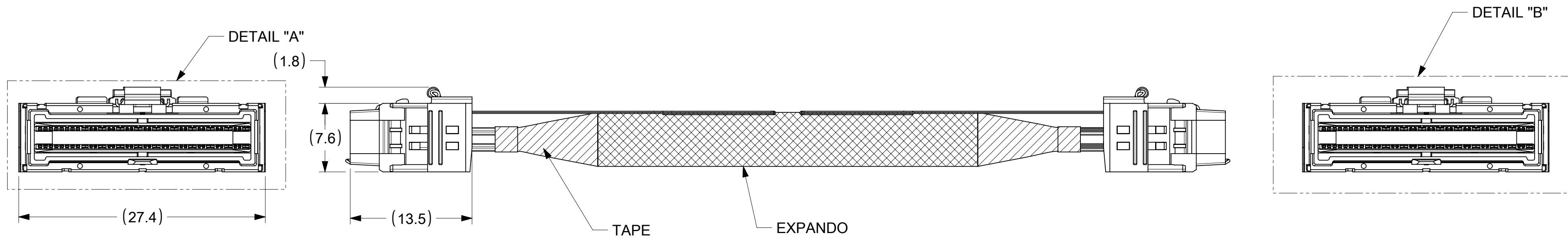
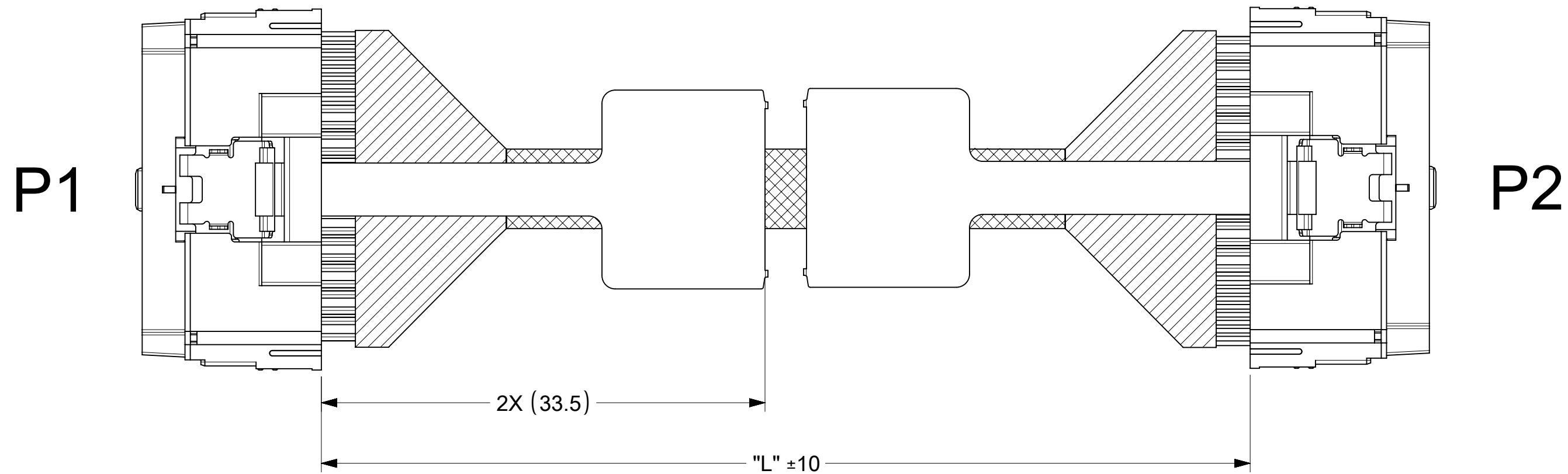

NOTES:

1. GENERAL:
 - 1.1 PRODUCT SPECIFICATION: 2080210001-PS
 - 1.2 APPLICATION SPECIFICATION: 2080210001-AS
 - 1.3 COSMETIC SPECIFICATION: PS-45499-002 CLASS B
 - 1.4 GEOMETRIC TOLERANCES: ASME Y14.5 2009
 - 1.5 MATES WITH: 2080211000 & 2080213000
2. DESIGN - MATERIALS:
 - 2.1 HOUSING MATERIAL: LCP, GLASS FILLED, UL94V-0, COLOR: BLACK
 - 2.2 CONTACT MATERIAL: HIGH PERFORMANCE COPPER ALLOY
 - 2.3 OVERMOLD: HOTMELT
 - 2.4 PROTECTIVE COVER: PP, BLUE
 - 2.5 PLATING: SELECT GOLD IN CONTACT AREA: 0.76 MICROMETERS MIN. OVER NICKEL

FUNCTIONAL SYMBOLS $\nabla_A = 0$ $\nabla_C = 0$ $\nabla_P = 0$ DIVISIONAL SYMBOLS	THIS DRAWING CONTAINS INFORMATION THAT IS PROPRIETARY TO MOLEX ELECTRONIC TECHNOLOGIES, LLC AND SHOULD NOT BE USED WITHOUT WRITTEN PERMISSION									
	DIMENSION UNITS	SCALE	CURRENT REV DESC:							
	mm	1:1	EC NO: 725729							
	GENERAL TOLERANCES (UNLESS SPECIFIED)			DRWN: MFAN08	2022/10/20	NEARSTACK VERTICAL PCIE CABLE ASSY				
	ANGULAR TOL ± °			CHK'D: ALVINZ	2022/10/24					
4 PLACES ±			APPR: XQHE	2022/10/26	PRODUCT CUSTOMER DRAWING					
3 PLACES ±			INITIAL REVISION:	DOCUMENT NUMBER	DOC TYPE	DOC PART	REVISION			
2 PLACES ±			DRWN: JRESENDEZ	2020/06/29	2166441000	PSD	000	G2		
1 PLACE ±			APPR: XQHE	2020/12/22	MATERIAL NUMBER	CUSTOMER	SHEET NUMBER			
0 PLACES ±			DRAFT WHERE APPLICABLE MUST REMAIN WITHIN DIMENSIONS	THIRD ANGLE PROJECTION	DRAWING	SERIES	216644	SEE TABLE	GENERAL MARKET	1 OF 8

DOCUMENT STATUS	P1	RELEASE DATE	2022/10/26	08:02:22
-----------------	----	--------------	------------	----------

18DP & 16SE (SINGLE ENDED) PINOUT

P1		P2	
CKT		CKT	
1	GND	28	GND
2	S	27	S
3	S	26	S
4	GND	25	GND
5	S	24	S
6	S	23	S
7	GND	22	GND
8	S	21	S
9	S	20	S
10	GND	19	GND
11	S	18	S
12	S	17	S
13	GND	16	GND
14	S	15	S
15	S	14	S
16	GND	13	GND
17	S	12	S
18	S	11	S
19	GND	10	GND
20	S	9	S
21	S	8	S
22	GND	7	GND
23	S	6	S
24	S	5	S
25	GND	4	GND
26	S	3	S
27	S	2	S
28	GND	1	GND
29	SE	36	SE
30	SE	35	SE
31	SE	34	SE
32	SE	33	SE
33	SE	32	SE
34	SE	31	SE
35	SE	30	SE
36	SE	29	SE

P1		P2	
CKT		CKT	
37	SE	44	SE
38	SE	43	SE
39	SE	42	SE
40	SE	41	SE
41	SE	40	SE
42	SE	39	SE
43	SE	38	SE
44	SE	37	SE
45	GND	72	GND
46	S	71	S
47	S	70	S
48	GND	69	GND
49	S	68	S
50	S	67	S
51	GND	66	GND
52	S	65	S
53	S	64	S
54	GND	63	GND
55	S	62	S
56	S	61	S
57	GND	60	GND
58	S	59	S
59	S	58	S
60	GND	57	GND
61	S	56	S
62	S	55	S
63	GND	54	GND
64	S	53	S
65	S	52	S
66	GND	51	GND
67	S	50	S
68	S	49	S
69	GND	48	GND
70	S	47	S
71	S	46	S
72	GND	45	GND

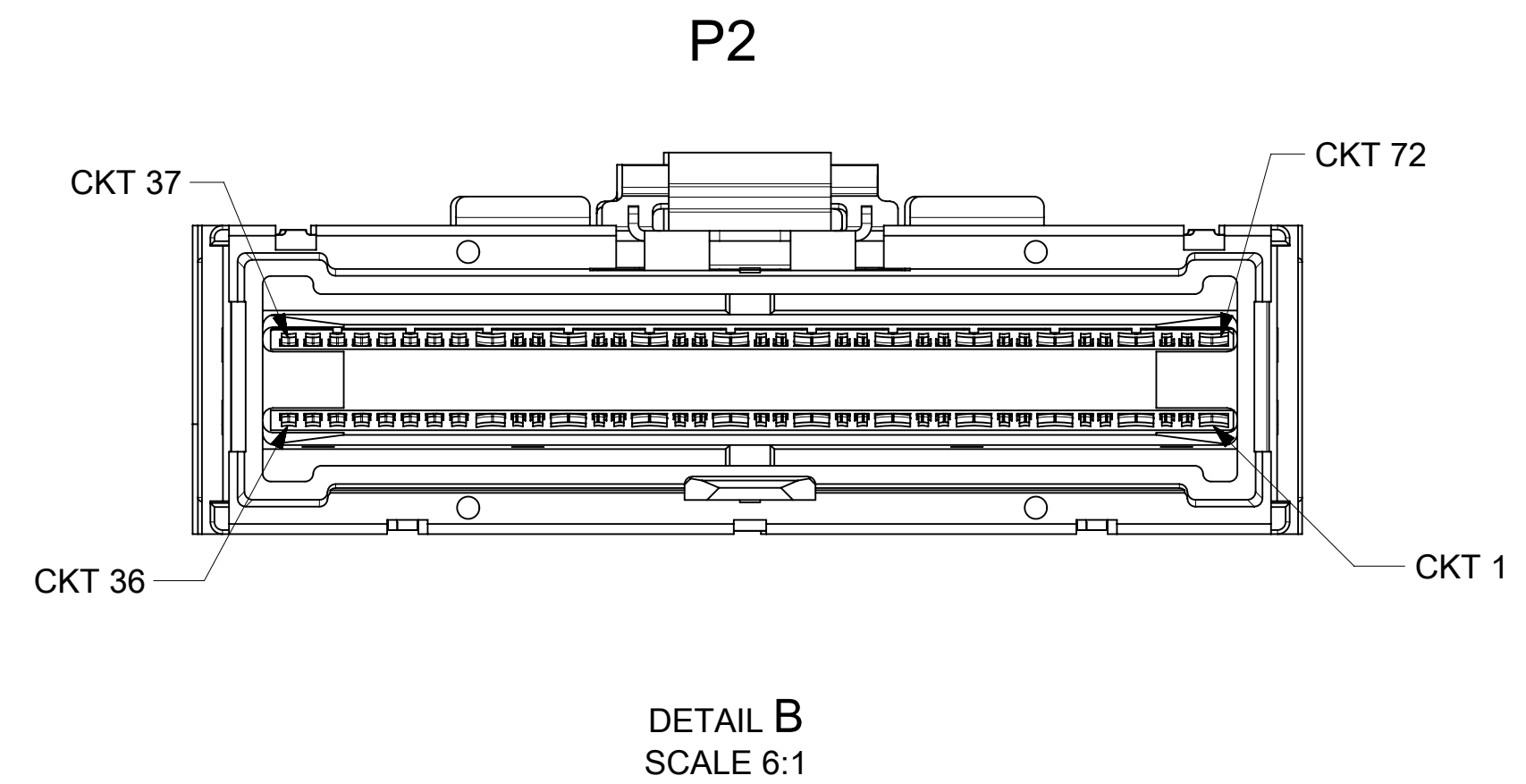
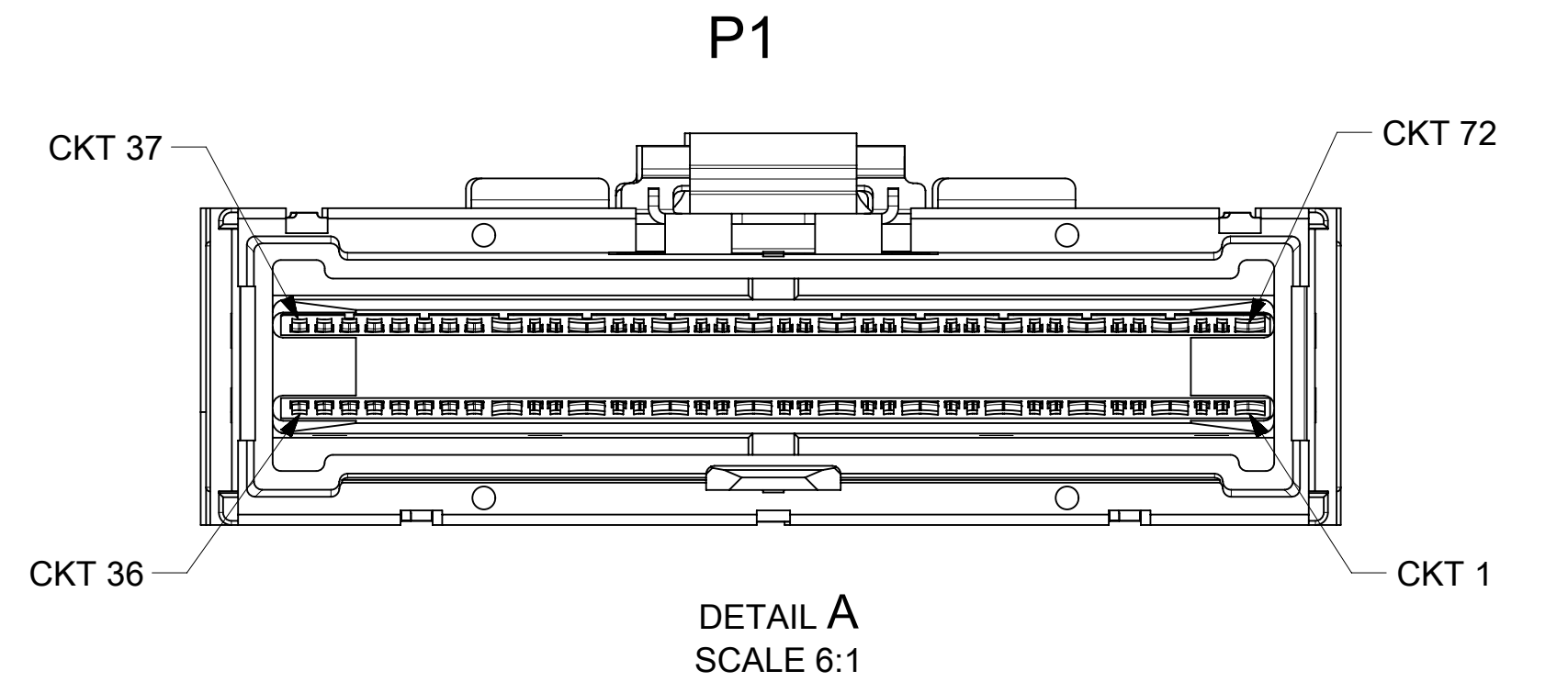

FUNCTIONAL SYMBOLS	THIS DRAWING CONTAINS INFORMATION THAT IS PROPRIETARY TO MOLEX ELECTRONIC TECHNOLOGIES, LLC AND SHOULD NOT BE USED WITHOUT WRITTEN PERMISSION								
	DIMENSION UNITS	SCALE	CURRENT REV DESC:						
$\nabla_A = 0$	mm	1:1	EC NO: 725729 DRWN: MFAN08 CHK'D: ALVINZ APPR: XQHE						
$\nabla_C = 0$	GENERAL TOLERANCES (UNLESS SPECIFIED)								
$\nabla_P = 0$	ANGULAR TOL ± °								
DIVISIONAL SYMBOLS	4 PLACES ±	2022/10/20							
	3 PLACES ±	2022/10/24	INITIAL REVISION: DRWN: JRESENDEZ APPR: XQHE						
	2 PLACES ±	2022/10/26							
	1 PLACE ±	2020/06/29	DOCUMENT NUMBER						
	0 PLACES ±	2020/12/22		2166441000					
DRAFT WHERE APPLICABLE MUST REMAIN WITHIN DIMENSIONS		THIRD ANGLE PROJECTION	DRAWING	SERIES	MATERIAL NUMBER	CUSTOMER	DOC TYPE	DOC PART	REVISION
			C-SIZE	216644	SEE TABLE	GENERAL MARKET	PSD	000	G2
DOCUMENT STATUS		P1	RELEASE DATE	2022/10/26 08:02:22	SHEET NUMBER				
					2 OF 8				

molex

NEARSTACK VERTICAL PCIE CABLE ASSY

PRODUCT CUSTOMER DRAWING

DOCUMENT NUMBER

2166441000

PSD 000 G2

MATERIAL NUMBER CUSTOMER

SEE TABLE GENERAL MARKET

DOC TYPE

000

G2

SHEET NUMBER

2 OF 8

FINISHED GOODS PN	DESCRIPTION	DIMENSION "L"
2207530250	LONG PT DONOR	250
2207530275	LONG PT DONOR	275
2207530300	LONG PT DONOR	300
2207530325	LONG PT DONOR	325
2207530350	LONG PT DONOR	350
2207530375	LONG PT DONOR	375
2207530400	LONG PT DONOR	400
2207530425	LONG PT DONOR	425
2207530450	LONG PT DONOR	450
2207530475	LONG PT DONOR	475
2207530500	LONG PT DONOR	500
2207530525	LONG PT DONOR	525
2207530550	LONG PT DONOR	550
2207530575	LONG PT DONOR	575
2207530600	LONG PT DONOR	600
2207530625	LONG PT DONOR	625
2207530650	LONG PT DONOR	650
2207530675	LONG PT DONOR	675
2207530700	LONG PT DONOR	700
2207530725	LONG PT DONOR	725
2207530750	LONG PT DONOR	750
2207530775	LONG PT DONOR	775
2207530800	LONG PT DONOR	800
2207530825	LONG PT DONOR	825
2207530850	LONG PT DONOR	850
2207530875	LONG PT DONOR	875
2207530900	LONG PT DONOR	900
2207530925	LONG PT DONOR	925
2207530950	LONG PT DONOR	950
2207530975	LONG PT DONOR	975
2207531000	LONG PT DONOR	1000
2207531025	LONG PT DONOR	1025
2207531050	LONG PT DONOR	1050
2207531075	LONG PT DONOR	1075
2207531100	LONG PT DONOR	1100
2207531125	LONG PT DONOR	1125
2207531150	LONG PT DONOR	1150
2207531175	LONG PT DONOR	1175
2207531200	LONG PT DONOR	1200
2207531225	LONG PT DONOR	1225
2207531250	LONG PT DONOR	1250
2207531275	LONG PT DONOR	1275
2207531300	LONG PT DONOR	1300
2207531325	LONG PT DONOR	1325
2207531350	LONG PT DONOR	1350
2207531375	LONG PT DONOR	1375
2207531400	LONG PT DONOR	1400
2207531425	LONG PT DONOR	1425
2207531450	LONG PT DONOR	1450
2207531475	LONG PT DONOR	1475
2207531500	LONG PT DONOR	1500
2207531625	LONG PT DONOR	1625
2207531650	LONG PT DONOR	1650
2207531800	LONG PT DONOR	1800
2207532050	LONG PT DONOR	2050

FINISHED GOODS PN	DESCRIPTION	DIMENSION "L"
2202540250	LONG PT FINISHED GOODS	250
2202540275	LONG PT FINISHED GOODS	275
2202540300	LONG PT FINISHED GOODS	300
2202540325	LONG PT FINISHED GOODS	325
2202540350	LONG PT FINISHED GOODS	350
2202540375	LONG PT FINISHED GOODS	375
2202540400	LONG PT FINISHED GOODS	400
2202540425	LONG PT FINISHED GOODS	425
2202540450	LONG PT FINISHED GOODS	450
2202540475	LONG PT FINISHED GOODS	475
2202540500	LONG PT FINISHED GOODS	500
2202540525	LONG PT FINISHED GOODS	525
2202540550	LONG PT FINISHED GOODS	550
2202540575	LONG PT FINISHED GOODS	575
2202540600	LONG PT FINISHED GOODS	600
2202540625	LONG PT FINISHED GOODS	625
2202540650	LONG PT FINISHED GOODS	650
2202540675	LONG PT FINISHED GOODS	675
2202540700	LONG PT FINISHED GOODS	700
2202540725	LONG PT FINISHED GOODS	725
2202540750	LONG PT FINISHED GOODS	750
2202540775	LONG PT FINISHED GOODS	775
2202540800	LONG PT FINISHED GOODS	800
2202540825	LONG PT FINISHED GOODS	825
2202540850	LONG PT FINISHED GOODS	850
2202540875	LONG PT FINISHED GOODS	875
2202540900	LONG PT FINISHED GOODS	900
2202540925	LONG PT FINISHED GOODS	925
2202540950	LONG PT FINISHED GOODS	950
2202540975	LONG PT FINISHED GOODS	975
2202541000	LONG PT FINISHED GOODS	1000
2202541025	LONG PT FINISHED GOODS	1025
2202541050	LONG PT FINISHED GOODS	1050
2202541075	LONG PT FINISHED GOODS	1075
2202541100	LONG PT FINISHED GOODS	1100
2202541125	LONG PT FINISHED GOODS	1125
2202541150	LONG PT FINISHED GOODS	1150
2202541175	LONG PT FINISHED GOODS	1175
2202541200	LONG PT FINISHED GOODS	1200
2202541225	LONG PT FINISHED GOODS	1225
2202541250	LONG PT FINISHED GOODS	1250
2202541275	LONG PT FINISHED GOODS	1275
2202541300	LONG PT FINISHED GOODS	1300
2202541325	LONG PT FINISHED GOODS	1325
2202541350	LONG PT FINISHED GOODS	1350
2202541375	LONG PT FINISHED GOODS	1375
2202541400	LONG PT FINISHED GOODS	1400
2202541425	LONG PT FINISHED GOODS	1425
2202541450	LONG PT FINISHED GOODS	1450
2202541475	LONG PT FINISHED GOODS	1475
2202541500	LONG PT FINISHED GOODS	1500
2202541625	LONG PT FINISHED GOODS	1625
2202541650	LONG PT FINISHED GOODS	1650
2202541800	LONG PT FINISHED GOODS	1800
2202542050	LONG PT FINISHED GOODS	2050

220753 SERIES IS LONG PULL TAB TYPE WITHOUT TAPE AND EXPANDO
220254 SERIES IS LONG PULL TAB TYPE WITH TAPE AND EXPANDO

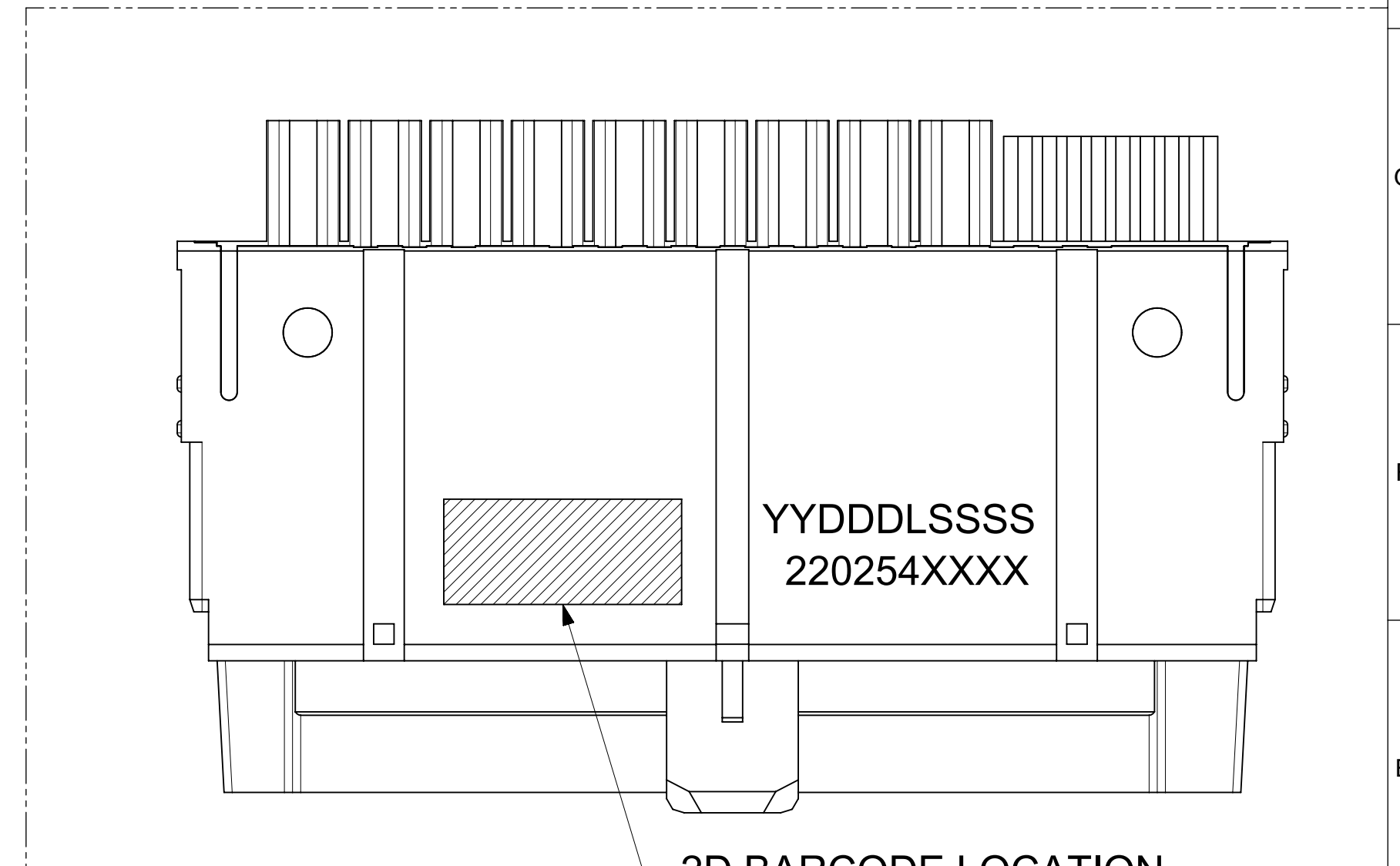

2D BARCODE LOCATION
(FOR REFERENCE)

1. FORMAT: YY=YEAR DDD=JULIAN DATE
SSSS=SERIAL NO. FROM 0000-9999 AND
WILL RESET EVERYDAY
L=PRODUCTION LINE CODE
2. 220254XXXX IS THE PART NUMBER OF THE CABLE
3. ALL THE 2D BARCODE PN AND SN ARE PRINTED
ON BOTH P1 AND P2 END
4. THIS FORMAT APPLIES TO ALL THE SERIES#
CALLED OUT ON THIS DRAWING

FUNCTIONAL SYMBOLS	THIS DRAWING CONTAINS INFORMATION THAT IS PROPRIETARY TO MOLEX ELECTRONIC TECHNOLOGIES, LLC AND SHOULD NOT BE USED WITHOUT WRITTEN PERMISSION						
	DIMENSION UNITS	SCALE	CURRENT REV DESC:				
$\nabla_A = 0$	mm	1:1	EC NO: 725729 DRWN: MFAN08 CHK'D: ALVINZ APPR: XQHE				
$\nabla_C = 0$	GENERAL TOLERANCES (UNLESS SPECIFIED)						
$\nabla_P = 0$	ANGULAR TOL ± °						
DIVISIONAL SYMBOLS	4 PLACES ±	2022/10/20					
	3 PLACES ±	2022/10/24	INITIAL REVISION: DRWN: JRESENDEZ APPR: XQHE				
	2 PLACES ±	2022/10/26					
	1 PLACE ±	2020/06/29	DOCUMENT NUMBER 2166441000				
	0 PLACES ±	2020/12/22					
DRAFT WHERE APPLICABLE MUST REMAIN WITHIN DIMENSIONS		THIRD ANGLE PROJECTION	DRAWING	SERIES	MATERIAL NUMBER	CUSTOMER	SHEET NUMBER
			C-SIZE	216644	SEE TABLE	GENERAL MARKET	3 OF 8

molex

NEARSTACK VERTICAL PCIE CABLE ASSY

PRODUCT CUSTOMER DRAWING

SHORT PULL TAB TYPE

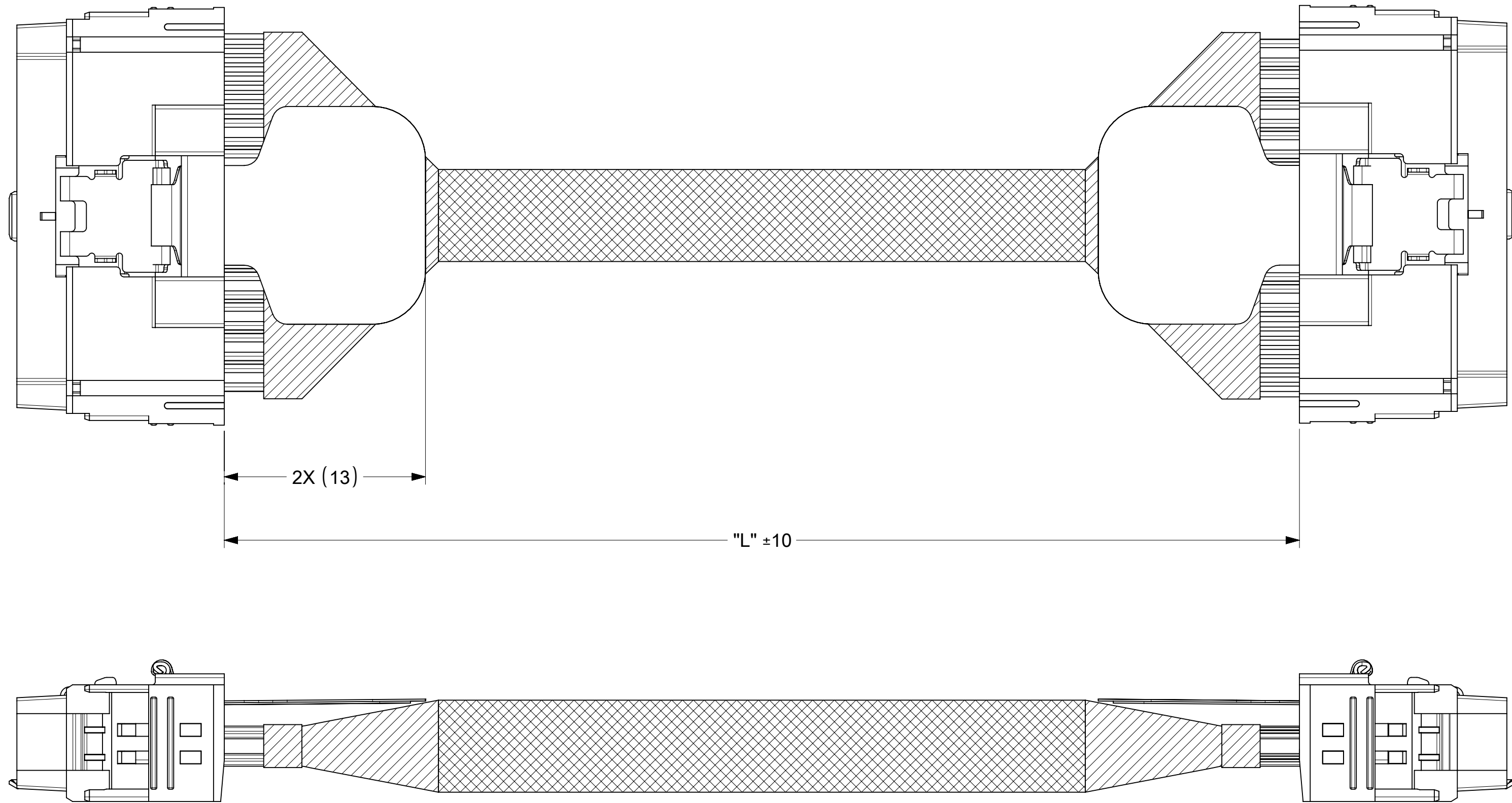

FUNCTIONAL SYMBOLS	THIS DRAWING CONTAINS INFORMATION THAT IS PROPRIETARY TO MOLEX ELECTRONIC TECHNOLOGIES, LLC AND SHOULD NOT BE USED WITHOUT WRITTEN PERMISSION								
	DIMENSION UNITS	SCALE	CURRENT REV DESC:						
$\nabla_A = 0$	mm	4:1	EC NO: 725729 DRWN: MFAN08 CHK'D: ALVINZ APPR: XQHE						
$\nabla_C = 0$	GENERAL TOLERANCES (UNLESS SPECIFIED)								
$\nabla_P = 0$	ANGULAR TOL ± °		2022/10/20						
DIVISIONAL SYMBOLS	4 PLACES ±		2022/10/24						
	3 PLACES ±		2022/10/26						
	2 PLACES ±		INITIAL REVISION:						
	1 PLACE ±		DRWN: JRESENDEZ APPR: XQHE						
0 PLACES ±		2020/06/29 2020/12/22	DOCUMENT NUMBER						
DRAFT WHERE APPLICABLE MUST REMAIN WITHIN DIMENSIONS		THIRD ANGLE PROJECTION	DRAWING	SERIES	MATERIAL NUMBER	CUSTOMER	DOC TYPE	DOC PART	REVISION
			C-SIZE	216644	2166441000	GENERAL MARKET	PSD	000	G2

molex

NEARSTACK VERTICAL PCIE CABLE ASSY

PRODUCT CUSTOMER DRAWING

2166441000

PSD 000 G2

SEE TABLE

GENERAL MARKET

SHEET NUMBER 4 OF 8

FINISHED GOODS PN	DESCRIPTION	DIMENSION "L"
2237660250	SHORT PT DONOR	250
2237660275	SHORT PT DONOR	275
2237660300	SHORT PT DONOR	300
2237660325	SHORT PT DONOR	325
2237660350	SHORT PT DONOR	350
2237660375	SHORT PT DONOR	375
2237660400	SHORT PT DONOR	400
2237660425	SHORT PT DONOR	425
2237660450	SHORT PT DONOR	450
2237660475	SHORT PT DONOR	475
2237660500	SHORT PT DONOR	500
2237660525	SHORT PT DONOR	525
2237660550	SHORT PT DONOR	550
2237660575	SHORT PT DONOR	575
2237660600	SHORT PT DONOR	600
2237660625	SHORT PT DONOR	625
2237660650	SHORT PT DONOR	650
2237660675	SHORT PT DONOR	675
2237660700	SHORT PT DONOR	700
2237660725	SHORT PT DONOR	725
2237660750	SHORT PT DONOR	750
2237660775	SHORT PT DONOR	775
2237660800	SHORT PT DONOR	800
2237660825	SHORT PT DONOR	825
2237660850	SHORT PT DONOR	850
2237660875	SHORT PT DONOR	875
2237660900	SHORT PT DONOR	900
2237660925	SHORT PT DONOR	925
2237660950	SHORT PT DONOR	950
2237660975	SHORT PT DONOR	975
2237661000	SHORT PT DONOR	1000
2237661025	SHORT PT DONOR	1025
2237661050	SHORT PT DONOR	1050
2237661075	SHORT PT DONOR	1075
2237661100	SHORT PT DONOR	1100
2237661125	SHORT PT DONOR	1125
2237661150	SHORT PT DONOR	1150
2237661175	SHORT PT DONOR	1175
2237661200	SHORT PT DONOR	1200
2237661225	SHORT PT DONOR	1225
2237661250	SHORT PT DONOR	1250
2237661275	SHORT PT DONOR	1275
2237661300	SHORT PT DONOR	1300
2237661325	SHORT PT DONOR	1325
2237661350	SHORT PT DONOR	1350
2237661375	SHORT PT DONOR	1375
2237661400	SHORT PT DONOR	1400
2237661425	SHORT PT DONOR	1425
2237661450	SHORT PT DONOR	1450
2237661475	SHORT PT DONOR	1475
2237661500	SHORT PT DONOR	1500
2237661625	SHORT PT DONOR	1625
2237661650	SHORT PT DONOR	1650
2237661800	SHORT PT DONOR	1800
2237662050	SHORT PT DONOR	2050

FINISHED GOODS PN	DESCRIPTION	DIMENSION "L"
2202640250	SHORT PT FINISHED GOODS	250
2202640275	SHORT PT FINISHED GOODS	275
2202640300	SHORT PT FINISHED GOODS	300
2202640325	SHORT PT FINISHED GOODS	325
2202640350	SHORT PT FINISHED GOODS	350
2202640375	SHORT PT FINISHED GOODS	375
2202640400	SHORT PT FINISHED GOODS	400
2202640425	SHORT PT FINISHED GOODS	425
2202640450	SHORT PT FINISHED GOODS	450
2202640475	SHORT PT FINISHED GOODS	475
2202640500	SHORT PT FINISHED GOODS	500
2202640525	SHORT PT FINISHED GOODS	525
2202640550	SHORT PT FINISHED GOODS	550
2202640575	SHORT PT FINISHED GOODS	575
2202640600	SHORT PT FINISHED GOODS	600
2202640625	SHORT PT FINISHED GOODS	625
2202640650	SHORT PT FINISHED GOODS	650
2202640675	SHORT PT FINISHED GOODS	675
2202640700	SHORT PT FINISHED GOODS	700
2202640725	SHORT PT FINISHED GOODS	725
2202640750	SHORT PT FINISHED GOODS	750
2202640775	SHORT PT FINISHED GOODS	775
2202640800	SHORT PT FINISHED GOODS	800
2202640825	SHORT PT FINISHED GOODS	825
2202640850	SHORT PT FINISHED GOODS	850
2202640875	SHORT PT FINISHED GOODS	875
2202640900	SHORT PT FINISHED GOODS	900
2202640925	SHORT PT FINISHED GOODS	925
2202640950	SHORT PT FINISHED GOODS	950
2202640975	SHORT PT FINISHED GOODS	975
2202641000	SHORT PT FINISHED GOODS	1000
2202641025	SHORT PT FINISHED GOODS	1025
2202641050	SHORT PT FINISHED GOODS	1050
2202641075	SHORT PT FINISHED GOODS	1075
2202641100	SHORT PT FINISHED GOODS	1100
2202641125	SHORT PT FINISHED GOODS	1125
2202641150	SHORT PT FINISHED GOODS	1150
2202641175	SHORT PT FINISHED GOODS	1175
2202641200	SHORT PT FINISHED GOODS	1200
2202641225	SHORT PT FINISHED GOODS	1225
2202641250	SHORT PT FINISHED GOODS	1250
2202641275	SHORT PT FINISHED GOODS	1275
2202641300	SHORT PT FINISHED GOODS	1300
2202641325	SHORT PT FINISHED GOODS	1325
2202641350	SHORT PT FINISHED GOODS	1350
2202641375	SHORT PT FINISHED GOODS	1375
2202641400	SHORT PT FINISHED GOODS	1400
2202641425	SHORT PT FINISHED GOODS	1425
2202641450	SHORT PT FINISHED GOODS	1450
2202641475	SHORT PT FINISHED GOODS	1475
2202641500	SHORT PT FINISHED GOODS	1500
2202641625	SHORT PT FINISHED GOODS	1625
2202641650	SHORT PT FINISHED GOODS	1650
2202641800	SHORT PT FINISHED GOODS	1800
2202642050	SHORT PT FINISHED GOODS	2050

223766 SERIES IS SHORT PULL TAB TYPE WITHOUT TAPE AND EXPANDO
220264 SERIES IS SHORT PULL TAB TYPE WITH TAPE AND EXPANDO

FUNCTIONAL SYMBOLS FA = 0 FE = 0 FP = 0 DIVISIONAL SYMBOLS	THIS DRAWING CONTAINS INFORMATION THAT IS PROPRIETARY TO MOLEX ELECTRONIC TECHNOLOGIES, LLC AND SHOULD NOT BE USED WITHOUT WRITTEN PERMISSION			
	DIMENSION UNITS	SCALE	CURRENT REV DESC:	
	mm	1:1		
	GENERAL TOLERANCES (UNLESS SPECIFIED)			
	ANGULAR TOL	±	°	
	4 PLACES	±		
	3 PLACES	±		
	2 PLACES	±		
	1 PLACE	±		
	0 PLACES	±		
DRAFT WHERE APPLICABLE MUST REMAIN WITHIN DIMENSIONS		THIRD ANGLE PROJECTION	DRAWING	SERIES
			C-SIZE	216644
DOCUMENT STATUS		DOC TYPE	DOC PART	REVISION
P1	RELEASE DATE	2166441000	PSD	000
2022/10/26	08:02:22	GENERAL MARKET		G2
MATERIAL NUMBER		CUSTOMER	SHEET NUMBER	
SEE TABLE		GENERAL MARKET	5 OF 8	

THUMB LATCH TYPE

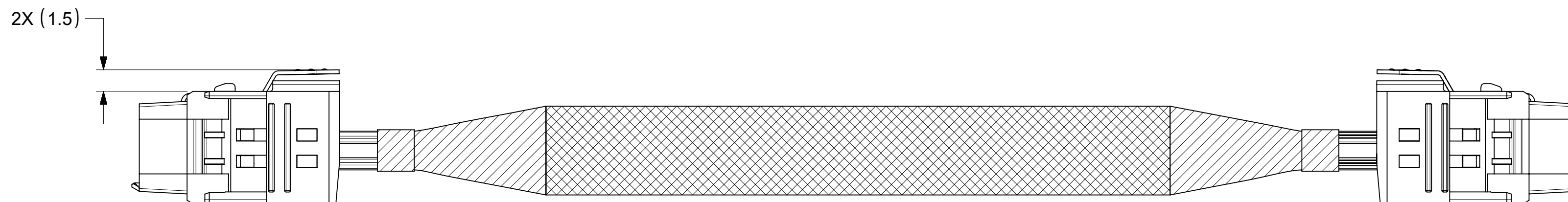
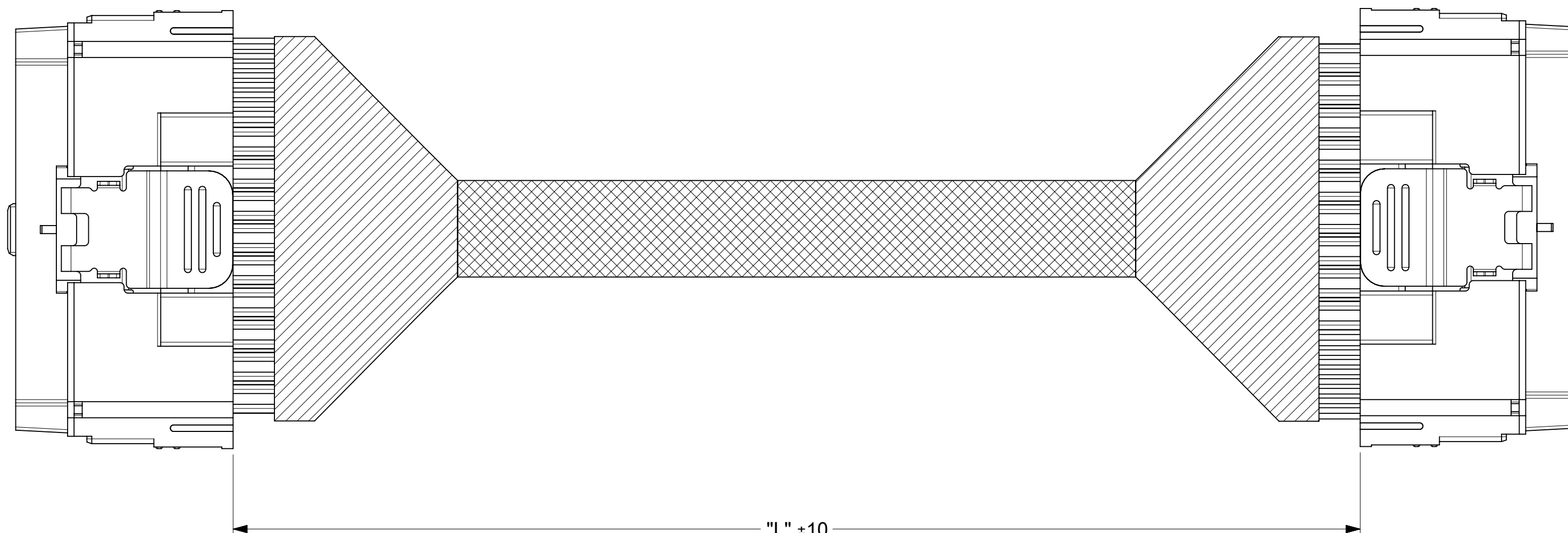

FUNCTIONAL SYMBOLS $\nabla_A = 0$ $\nabla_C = 0$ $\nabla_P = 0$	THIS DRAWING CONTAINS INFORMATION THAT IS PROPRIETARY TO MOLEX ELECTRONIC TECHNOLOGIES, LLC AND SHOULD NOT BE USED WITHOUT WRITTEN PERMISSION		CURRENT REV DESC:		
	DIMENSION UNITS	SCALE	EC NO: 725729		
	mm	1:1	DRWN: MFAN08 2022/10/20		
	GENERAL TOLERANCES (UNLESS SPECIFIED)		CHK'D: ALVINZ 2022/10/24		
ANGULAR TOL ± °		APPR: XQHE 2022/10/26		PRODUCT CUSTOMER DRAWING	
DIVISIONAL SYMBOLS		INITIAL REVISION:		DOCUMENT NUMBER	DOC TYPE DOC PART REVISION
4 PLACES ±		DRWN: JRESENDEZ 2020/06/29		2166441000	PSD 000 G2
3 PLACES ±		APPR: XQHE 2020/12/22			
2 PLACES ±		DRAFT WHERE APPLICABLE MUST REMAIN WITHIN DIMENSIONS		MATERIAL NUMBER	CUSTOMER
1 PLACE ±		THIRD ANGLE PROJECTION		SEE TABLE	GENERAL MARKET
0 PLACES ±		DRAWING		SHEET NUMBER	6 OF 8
		C-SIZE		SERIES	
				216644	

FINISHED GOODS PN	DESCRIPTION	DIMENSION "L"
2207540250	THUMB LATCH DONOR	250
2207540275	THUMB LATCH DONOR	275
2207540300	THUMB LATCH DONOR	300
2207540325	THUMB LATCH DONOR	325
2207540350	THUMB LATCH DONOR	350
2207540375	THUMB LATCH DONOR	375
2207540400	THUMB LATCH DONOR	400
2207540425	THUMB LATCH DONOR	425
2207540450	THUMB LATCH DONOR	450
2207540475	THUMB LATCH DONOR	475
2207540500	THUMB LATCH DONOR	500
2207540525	THUMB LATCH DONOR	525
2207540550	THUMB LATCH DONOR	550
2207540575	THUMB LATCH DONOR	575
2207540600	THUMB LATCH DONOR	600
2207540625	THUMB LATCH DONOR	625
2207540650	THUMB LATCH DONOR	650
2207540675	THUMB LATCH DONOR	675
2207540700	THUMB LATCH DONOR	700
2207540725	THUMB LATCH DONOR	725
2207540750	THUMB LATCH DONOR	750
2207540775	THUMB LATCH DONOR	775
2207540800	THUMB LATCH DONOR	800
2207540825	THUMB LATCH DONOR	825
2207540850	THUMB LATCH DONOR	850
2207540875	THUMB LATCH DONOR	875
2207540900	THUMB LATCH DONOR	900
2207540925	THUMB LATCH DONOR	925
2207540950	THUMB LATCH DONOR	950
2207540975	THUMB LATCH DONOR	975
2207541000	THUMB LATCH DONOR	1000
2207541025	THUMB LATCH DONOR	1025
2207541050	THUMB LATCH DONOR	1050
2207541075	THUMB LATCH DONOR	1075
2207541100	THUMB LATCH DONOR	1100
2207541125	THUMB LATCH DONOR	1125
2207541150	THUMB LATCH DONOR	1150
2207541175	THUMB LATCH DONOR	1175
2207541200	THUMB LATCH DONOR	1200
2207541225	THUMB LATCH DONOR	1225
2207541250	THUMB LATCH DONOR	1250
2207541275	THUMB LATCH DONOR	1275
2207541300	THUMB LATCH DONOR	1300
2207541325	THUMB LATCH DONOR	1325
2207541350	THUMB LATCH DONOR	1350
2207541375	THUMB LATCH DONOR	1375
2207541400	THUMB LATCH DONOR	1400
2207541425	THUMB LATCH DONOR	1425
2207541450	THUMB LATCH DONOR	1450
2207541475	THUMB LATCH DONOR	1475
2207541500	THUMB LATCH DONOR	1500
2207541625	THUMB LATCH DONOR	1625
2207541650	THUMB LATCH DONOR	1650
2207541800	THUMB LATCH DONOR	1800
2207542050	THUMB LATCH DONOR	2050

FINISHED GOODS PN	DESCRIPTION	DIMENSION "L"
2202650250	THUMB LATCH FINISHED GOODS	250
2202650275	THUMB LATCH FINISHED GOODS	275
2202650300	THUMB LATCH FINISHED GOODS	300
2202650325	THUMB LATCH FINISHED GOODS	325
2202650350	THUMB LATCH FINISHED GOODS	350
2202650375	THUMB LATCH FINISHED GOODS	375
2202650400	THUMB LATCH FINISHED GOODS	400
2202650425	THUMB LATCH FINISHED GOODS	425
2202650450	THUMB LATCH FINISHED GOODS	450
2202650475	THUMB LATCH FINISHED GOODS	475
2202650500	THUMB LATCH FINISHED GOODS	500
2202650525	THUMB LATCH FINISHED GOODS	525
2202650550	THUMB LATCH FINISHED GOODS	550
2202650575	THUMB LATCH FINISHED GOODS	575
2202650600	THUMB LATCH FINISHED GOODS	600
2202650625	THUMB LATCH FINISHED GOODS	625
2202650650	THUMB LATCH FINISHED GOODS	650
2202650675	THUMB LATCH FINISHED GOODS	675
2202650700	THUMB LATCH FINISHED GOODS	700
2202650725	THUMB LATCH FINISHED GOODS	725
2202650750	THUMB LATCH FINISHED GOODS	750
2202650775	THUMB LATCH FINISHED GOODS	775
2202650800	THUMB LATCH FINISHED GOODS	800
2202650825	THUMB LATCH FINISHED GOODS	825
2202650850	THUMB LATCH FINISHED GOODS	850
2202650875	THUMB LATCH FINISHED GOODS	875
2202650900	THUMB LATCH FINISHED GOODS	900
2202650925	THUMB LATCH FINISHED GOODS	925
2202650950	THUMB LATCH FINISHED GOODS	950
2202650975	THUMB LATCH FINISHED GOODS	975
2202651000	THUMB LATCH FINISHED GOODS	1000
2202651025	THUMB LATCH FINISHED GOODS	1025
2202651050	THUMB LATCH FINISHED GOODS	1050
2202651075	THUMB LATCH FINISHED GOODS	1075
2202651100	THUMB LATCH FINISHED GOODS	1100
2202651125	THUMB LATCH FINISHED GOODS	1125
2202651150	THUMB LATCH FINISHED GOODS	1150
2202651175	THUMB LATCH FINISHED GOODS	1175
2202651200	THUMB LATCH FINISHED GOODS	1200
2202651225	THUMB LATCH FINISHED GOODS	1225
2202651250	THUMB LATCH FINISHED GOODS	1250
2202651275	THUMB LATCH FINISHED GOODS	1275
2202651300	THUMB LATCH FINISHED GOODS	1300
2202651325	THUMB LATCH FINISHED GOODS	1325
2202651350	THUMB LATCH FINISHED GOODS	1350
2202651375	THUMB LATCH FINISHED GOODS	1375
2202651400	THUMB LATCH FINISHED GOODS	1400
2202651425	THUMB LATCH FINISHED GOODS	1425
2202651450	THUMB LATCH FINISHED GOODS	1450
2202651475	THUMB LATCH FINISHED GOODS	1475
2202651500	THUMB LATCH FINISHED GOODS	1500
2202651625	THUMB LATCH FINISHED GOODS	1625
2202651650	THUMB LATCH FINISHED GOODS	1650
2202651800	THUMB LATCH FINISHED GOODS	1800
2202652050	THUMB LATCH FINISHED GOODS	2050

220754 SERIES IS THUMB LATCH TYPE WITHOUT TAPE AND EXPANDO
220265 SERIES IS THUMB LATCH TYPE WITH TAPE AND EXPANDO

FUNCTIONAL SYMBOLS = 0 = 0 = 0 DIVISIONAL SYMBOLS	THIS DRAWING CONTAINS INFORMATION THAT IS PROPRIETARY TO MOLEX ELECTRONIC TECHNOLOGIES, LLC AND SHOULD NOT BE USED WITHOUT WRITTEN PERMISSION		CURRENT REV DESC:		 NEARSTACK VERTICAL PCIE CABLE ASSY PRODUCT CUSTOMER DRAWING
	DIMENSION UNITS	SCALE	EC NO: 725729		
	mm	1:1	DRWN: MFAN08	2022/10/20	
	GENERAL TOLERANCES (UNLESS SPECIFIED)		CHK'D: ALVINZ	2022/10/24	
ANGULAR TOL ± °		APPR: XQHE	2022/10/26	DOCUMENT NUMBER	
4 PLACES ±		INITIAL REVISION:		2166441000	
3 PLACES ±		DRWN: JRESENDEZ		PSD 000 G2	
2 PLACES ±		APPR: XQHE		SERIES	
1 PLACE ±		2020/06/29		216644	
0 PLACES ±		2020/12/22		MATERIAL NUMBER	
DRAFT WHERE APPLICABLE MUST REMAIN WITHIN DIMENSIONS		THIRD ANGLE PROJECTION	DRAWING	C-SIZE	CUSTOMER
			C-SIZE	216644	GENERAL MARKET
					SHEET NUMBER
					7 OF 8

REVISION HISTORY

DATE	REVISION	DESCRIPTION	ENGINEER
2020/12/22	A	INITIAL RELEASE	MARTIN FAN
2021/01/22	A1	ADD FULL LENGTH OPTIONS IN THE TABLE	MARTIN FAN
2021/04/15	B	REMOVE BLACK STRIPE FROM PULL TAB	MARTIN FAN
2021/06/21	C	CHANGE THE PULL TAB	MARTIN FAN
2021/08/03	C1	UPDATE HOUSING MODEL TO REFLECT THE LATEST VIEWS	MARTIN FAN
2021/10/25	D	ADD AND DESIGN SHORT PULL TAB FOR PCIE VT	MARTIN FAN
2021/01/04	E	UPDATE THE PN TABLE TO INCLUDE NEW PN FOR DIRECT SHIPMENT	MARTIN FAN
2022/03/18	E1	ADD NEW SERIES# 220753 AND 220754 FOR DONOR THAT WILL BE SHIPPED DIRECTLY AND REMOVE THE SHORT PULL TAB TYPE	MARTIN FAN
2022/04/18	F	ADDED STIFFENER TO BE OVER-MOLDED INTO THE HOUSING AND CHANGE THE BRACKET	MARTIN FAN
2022/06/14	F1	ADD 2207530500 AND 2202540500 INTO PN CHART AT SHEET 1 ; REVISED CABLE LENGTH TOLERANCE TO ±10MM	MARTIN FAN
2022/09/07	G	ADD ADDITIONAL LENGHT OPTIONS FOR LONG PULL TAB TYPE AND THUMB LATCH TYPE AND ADD SHORT PULL TAB TYPE	MARTIN FAN
2022/10/11	G1	ADD LASER ETCHING INFORMATION (PN SN BARCODE) ON SHEET 3	MARTIN FAN
2022/10/24	G2	CHANGE THE LONG PULL TAB	MARTIN FAN

FUNCTIONAL SYMBOLS	THIS DRAWING CONTAINS INFORMATION THAT IS PROPRIETARY TO MOLEX ELECTRONIC TECHNOLOGIES, LLC AND SHOULD NOT BE USED WITHOUT WRITTEN PERMISSION					
	DIMENSION UNITS	SCALE	CURRENT REV DESC:			
= 0	mm	1:1	EC NO: 725729 DRWN: MFAN08 2022/10/20 CHK'D: ALVINZ 2022/10/24 APPR: XQHE 2022/10/26			
= 0	GENERAL TOLERANCES (UNLESS SPECIFIED)					
= 0	ANGULAR TOL ± °					
DIVISIONAL SYMBOLS	4 PLACES ±		INITIAL REVISION: DRWN: JRESENDEZ 2020/06/29 APPR: XQHE 2020/12/22			
	3 PLACES ±					
	2 PLACES ±					
	1 PLACE ±					
0 PLACES ±			DOCUMENT NUMBER: 2166441000 DOC TYPE: PSD DOC PART: 000 REVISION: G2			
DRAFT WHERE APPLICABLE MUST REMAIN WITHIN DIMENSIONS	THIRD ANGLE PROJECTION	DRAWING	SERIES	MATERIAL NUMBER	CUSTOMER	SHEET NUMBER
		C-SIZE	216644	SEE TABLE	GENERAL MARKET	8 OF 8

molex

NEARSTACK VERTICAL PCIE CABLE ASSY

PRODUCT CUSTOMER DRAWING

DOCUMENT STATUS	P1	RELEASE DATE	2022/10/26 08:02:22
-----------------	----	--------------	---------------------