

BZX784B5V1 thru BZX784B20

Surface Mount Zener Diodes

Vz Range: 5.1 to 20V Power Dissipation: 100mW

Features

- Planar die construction
- 100mW power dissipation



Schematic Diagram

Package: SOD-723

Absolute Maximum Ratings

(T_A=25°C unless otherwise noted)

Parameter	Symbol	Value	Unit
Forward Voltage @I _F =10mA	V _F	0.9	V
Power Dissipation	P _D	100	mW
Thermal Resistance from Junction to Ambient	R _{θJA}	1250	°C/W
Junction Temperature	T _J	150	°C
Storage Temperature	T _{STG}	-55 to +150	°C

Electrical Characteristics (T_A=25°C unless otherwise noted)

Type Number	Type Code	Zener Voltage Range (Note 1)				Maximum Zener Impedance (Note 2)			Maximum Reverse Current		Typical Temperature Coefficient @I _{ZT} =5 mA mV/°C	
		V _Z @I _{ZT}			I _{ZT}	Z _{ZT} @I _{ZT}	Z _{ZK} @I _{ZK}	I _{ZK}	I _R	V _R	Min	Max
		Nom(V)	Min(V)	Max(V)	mA	Ω		mA	uA	V		
BZX784B5V1	X2	5.1	5.00	5.20	5	60	480	1.0	2	2.0	-2.7	1.2
BZX784B5V6	X3	5.6	5.49	5.71	5	40	400	1.0	1	2.0	-2.0	2.5
BZX784B6V2	X4	6.2	6.08	6.32	5	10	150	1.0	3	4.0	0.4	3.7
BZX784B6V8	X5	6.8	6.66	6.94	5	15	80	1.0	2	4.0	1.2	4.5
BZX784B7V5	X6	7.5	7.35	7.65	5	15	80	1.0	1	5.0	2.5	5.3
BZX784B8V2	X7	8.2	8.04	8.36	5	15	80	1.0	0.7	5.0	3.2	6.2
BZX784B9V1	X8	9.1	8.92	9.28	5	15	100	1.0	0.5	6.0	3.8	7.0
BZX784B10	X9	10	9.80	10.20	5	20	150	1.0	0.2	7.0	4.5	8.0
BZX784B11	W1	11	10.78	11.22	5	20	150	1.0	0.1	8.0	5.4	9.0
BZX784B12	W2	12	11.76	12.24	5	25	150	1.0	0.1	8.0	6.0	10.0
BZX784B13	W3	13	12.74	13.26	5	30	170	1.0	0.1	8.0	7.0	11.0
BZX784B15	W4	15	14.70	15.30	5	30	200	1.0	0.1	10.5	9.2	13.0
BZX784B16	W5	16	15.68	16.32	5	40	200	1.0	0.1	11.2	10.4	14.0
BZX784B18	W6	18	17.64	18.36	5	45	225	1.0	0.1	12.6	12.4	16.0
BZX784B20	W7	20	19.60	20.40	5	55	225	1.0	0.1	14.0	14.4	18.0

Notes:

- Tested with pulses, period=5ms,pulse width =300μs.
- f=1kHz.

Typical Electrical Characteristic Curves

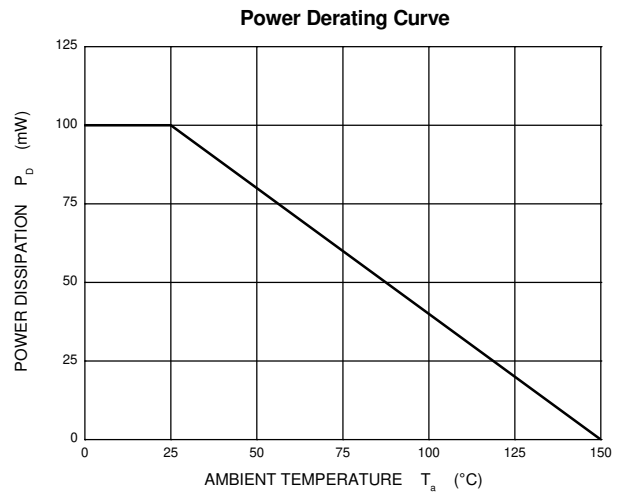
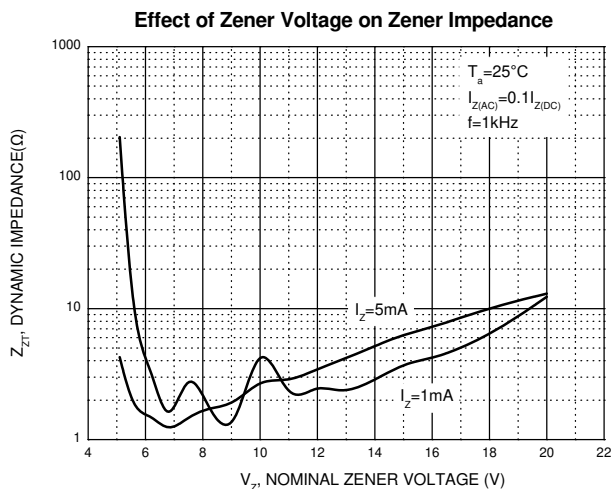
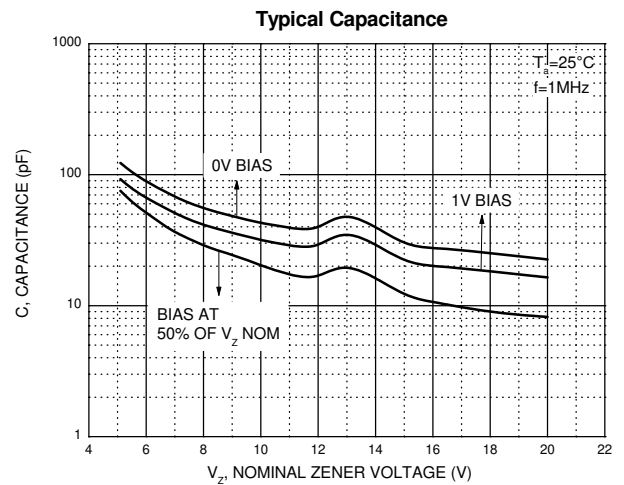
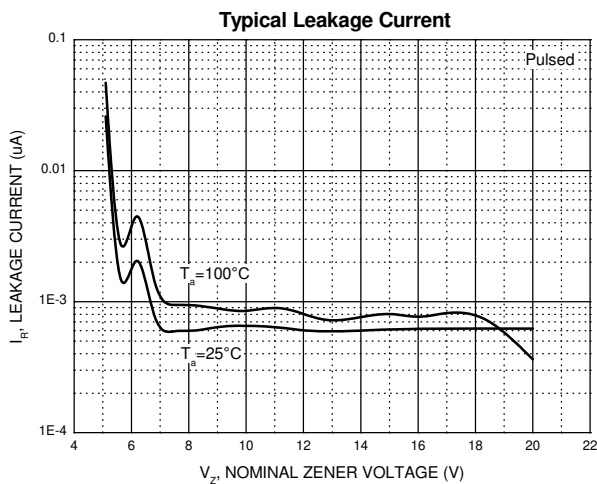
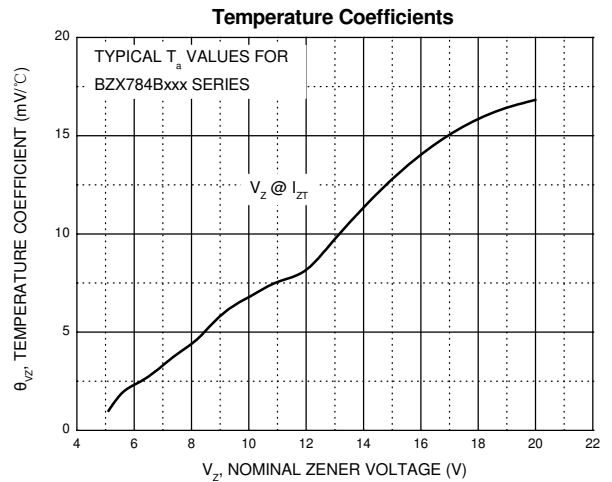
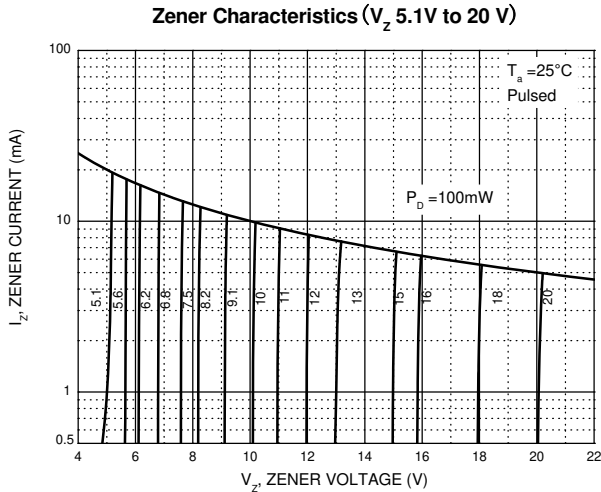

BZX784B5V1 thru BZX784B20

Surface Mount Zener Diodes

Vz Range: 5.1 to 20V Power Dissipation: 100mW

Package Outline Dimensions

SOD-723

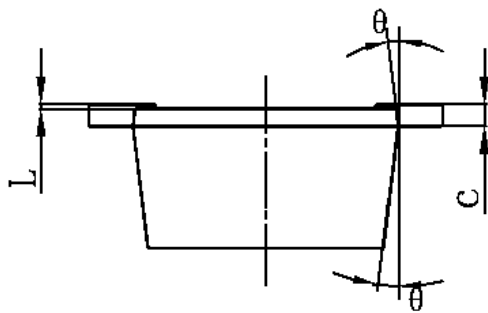
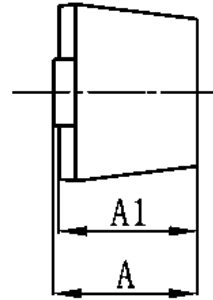
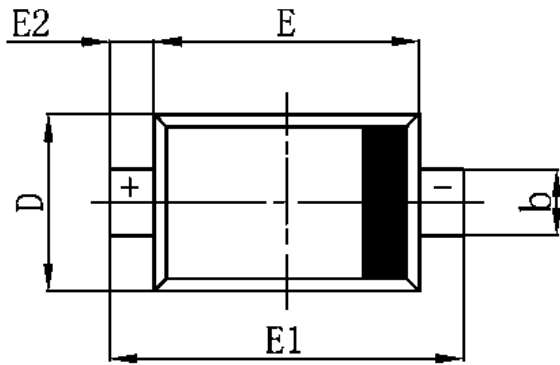

Symbol	Dimensions In Millimeters		Dimensions In Inches	
	Min	Max	Min	Max
A	0.525	0.650	0.021	0.026
A1	0.515	0.580	0.020	0.023
b	0.250	0.350	0.010	0.014
c	0.080	0.150	0.003	0.006
D	0.550	0.650	0.022	0.026
E	0.900	1.100	0.035	0.043
E1	1.300	1.500	0.051	0.059
E2	0.200 REF		0.008 REF	
L	0.010	0.070	0.001	0.003
θ	7° REF		7° REF	