

RECOMMENDED PCB(CONNECTOR SIDE VIEW)
THICKNESS=1.6 TO 2.4 MM

| | | | | | | |
|--------------------|---|--|-------------------|-----------------|--------------------------|---|
| FUNCTIONAL SYMBOLS | THIS DRAWING CONTAINS INFORMATION THAT IS PROPRIETARY TO MOLEX ELECTRONIC TECHNOLOGIES, LLC AND SHOULD NOT BE USED WITHOUT WRITTEN PERMISSION | | CURRENT REV DESC: | | molex | |
| | GENERAL TOLERANCES (UNLESS SPECIFIED) | ANGULAR TOL $\pm 3.0^\circ$ | EC NO: 697101 | 2022/02/24 | | HEADER OF NANO-FIT, D/R, CLIP, VERTICAL POWER CONNECTOR |
| DIVISIONAL SYMBOLS | 4 PLACES \pm | 3 PLACES ± 0.1 | DRWN: GLLI | 2022/02/25 | PRODUCT CUSTOMER DRAWING | |
| | 2 PLACES ± 0.2 | 1 PLACE ± 0.3 | APP'R: XQZHANG | 2022/02/25 | | DOCUMENT NUMBER |
| | 0 PLACES \pm | DRAFT WHERE APPLICABLE MUST REMAIN WITHIN DIMENSIONS | INITIAL REVISION: | DRWN: GLLI | 2019/09/24 | 1053121000-SD |
| | THIRD ANGLE PROJECTION | DRAWING | SERIES | MATERIAL NUMBER | CUSTOMER | DOC TYPE |
| | | | A3-SIZE | 105312 | GENERAL MARKET | DOC PART |
| | | | | | | REVISION |
| | | | | | | B1 |
| | | | | | | SHEET NUMBER |
| | | | | | | 1 OF 5 |

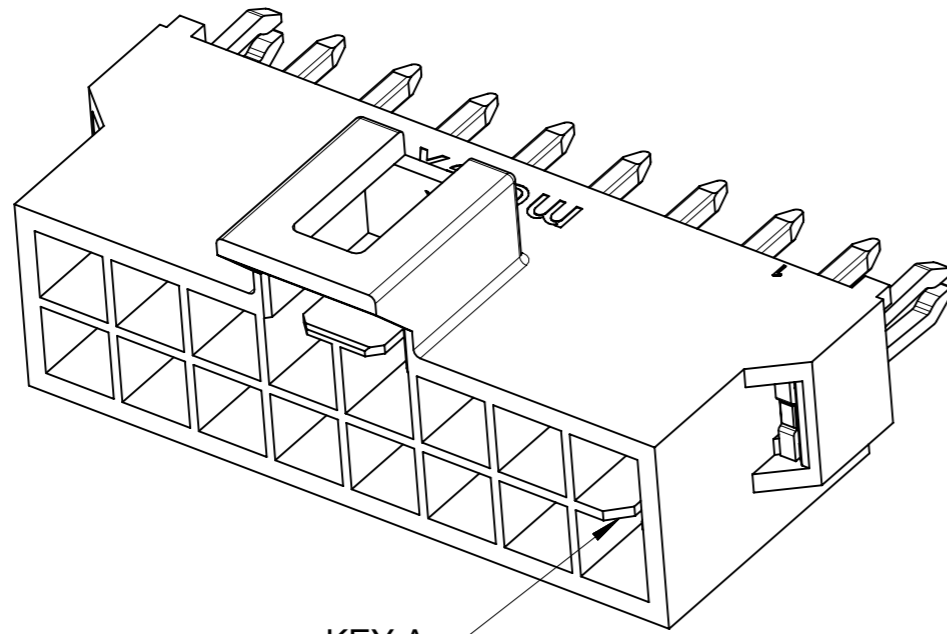

KEY A

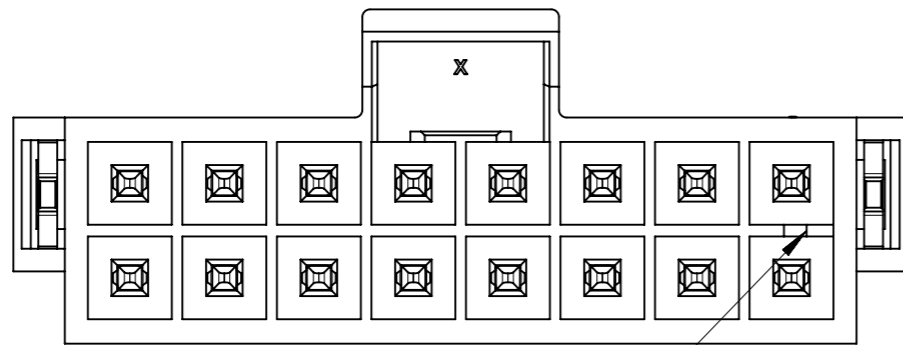

KEY A

BLACK

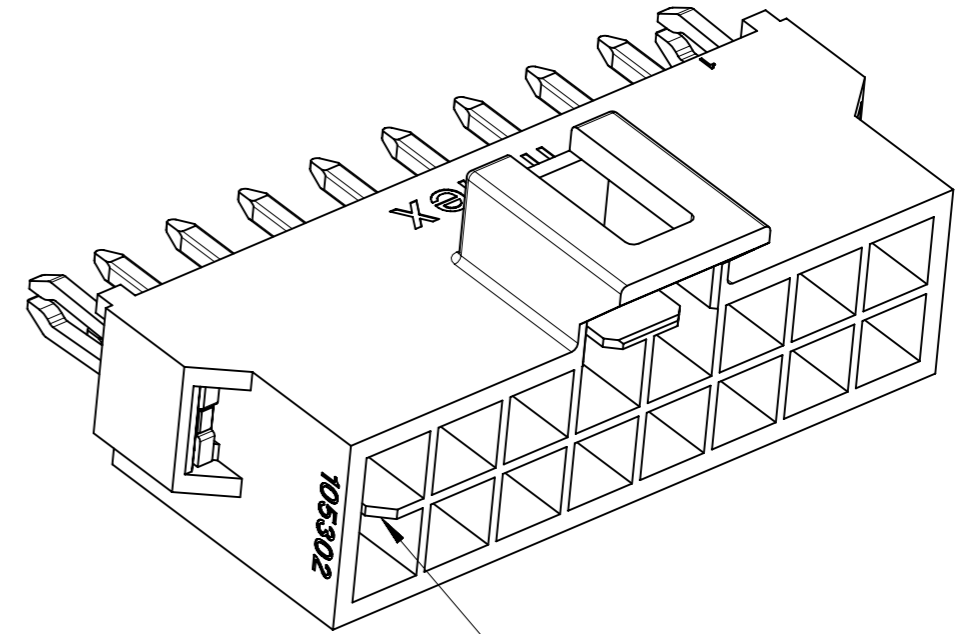

KEY B

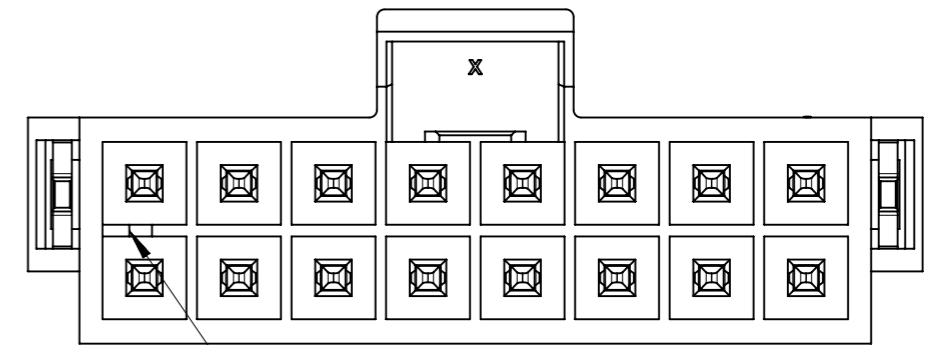

KEY B

NATURAL

COLOR OPTION

| | | | | | | | | | |
|--------------------|---|--|---|---------|---|--------|----------------|-----------|--------------|
| FUNCTIONAL SYMBOLS | THIS DRAWING CONTAINS INFORMATION THAT IS PROPRIETARY TO MOLEX ELECTRONIC TECHNOLOGIES, LLC AND SHOULD NOT BE USED WITHOUT WRITTEN PERMISSION | | CURRENT REV DESC: | | molex | | | | |
| | ▽A = 0 | mm | | | | | | SCALE 5:1 | |
| ▽E = 0 | GENERAL TOLERANCES (UNLESS SPECIFIED) | | EC NO: 697101 DRWN: GLLI 2022/02/24 CHK'D: XQZHANG 2022/02/25 APPR: XQZHANG 2022/02/25 INITIAL REVISION: DRWN: GLLI 2019/09/24 APPR: YXZHENG 2020/03/16 | | HEADER OF NANO-FIT, D/R, CLIP, VERTICAL POWER CONNECTOR | | | | |
| ▽E = 0 | ANGULAR TOL ± 3.0° | | | | PRODUCT CUSTOMER DRAWING | | | | |
| DIVISIONAL SYMBOLS | 4 PLACES | ± | | | DOCUMENT NUMBER | | DOC TYPE | DOC PART | REVISION |
| | 3 PLACES | ± 0.1 | | | 1053121000-SD | | PSD | 000 | B1 |
| | 2 PLACES | ± 0.2 | | | MATERIAL NUMBER | | CUSTOMER | | SHEET NUMBER |
| 1 PLACE | ± 0.3 | THIRD ANGLE PROJECTION | | DRAWING | | SERIES | | | |
| 0 PLACES | ± | DRAFT WHERE APPLICABLE MUST REMAIN WITHIN DIMENSIONS | | A3-SIZE | | 105312 | GENERAL MARKET | | |

| | | | | |
|-----------------|----|--------------|------------|----------|
| DOCUMENT STATUS | P1 | RELEASE DATE | 2022/02/25 | 03:08:44 |
|-----------------|----|--------------|------------|----------|

| PART NUMBER | DIM 'A' | DIM 'B' | DIM 'C' | CKT SIZE | PLATING | MYLAR |
|-------------|---------|---------|---------|----------|-----------|-------|
| 105312-3504 | 8.66 | 5.94 | 6.84 | 4 | TIN | |
| 105312-3506 | 11.16 | 8.44 | 9.34 | 6 | | |
| 105312-3508 | 13.66 | 10.94 | 11.84 | 8 | | |
| 105312-3510 | 16.16 | 13.44 | 14.34 | 10 | | |
| 105312-3512 | 18.66 | 15.94 | 16.84 | 12 | | |
| 105312-3514 | 21.16 | 18.44 | 19.34 | 14 | | |
| 105312-3516 | 23.66 | 20.94 | 21.84 | 16 | | |
| 105312-3704 | 8.66 | 5.94 | 6.84 | 4 | | |
| 105312-3706 | 11.16 | 8.44 | 9.34 | 6 | | |
| 105312-3708 | 13.66 | 10.94 | 11.84 | 8 | | |
| 105312-3710 | 16.16 | 13.44 | 14.34 | 10 | | |
| 105312-3712 | 18.66 | 15.94 | 16.84 | 12 | | |
| 105312-3714 | 21.16 | 18.44 | 19.34 | 14 | | |
| 105312-3716 | 23.66 | 20.94 | 21.84 | 16 | | |
| 105312-3604 | 8.66 | 5.94 | 6.84 | 4 | GOLD 0.76 | YES |
| 105312-3606 | 11.16 | 8.44 | 9.34 | 6 | | |
| 105312-3608 | 13.66 | 10.94 | 11.84 | 8 | | |
| 105312-3610 | 16.16 | 13.44 | 14.34 | 10 | | |
| 105312-3612 | 18.66 | 15.94 | 16.84 | 12 | | |
| 105312-3614 | 21.16 | 18.44 | 19.34 | 14 | | |
| 105312-3616 | 23.66 | 20.94 | 21.84 | 16 | | |
| 105312-3804 | 8.66 | 5.94 | 6.84 | 4 | | |
| 105312-3806 | 11.16 | 8.44 | 9.34 | 6 | | |
| 105312-3808 | 13.66 | 10.94 | 11.84 | 8 | | |
| 105312-3810 | 16.16 | 13.44 | 14.34 | 10 | | |
| 105312-3812 | 18.66 | 15.94 | 16.84 | 12 | | |
| 105312-3814 | 21.16 | 18.44 | 19.34 | 14 | | |
| 105312-3816 | 23.66 | 20.94 | 21.84 | 16 | | |

COLOR: BLACK

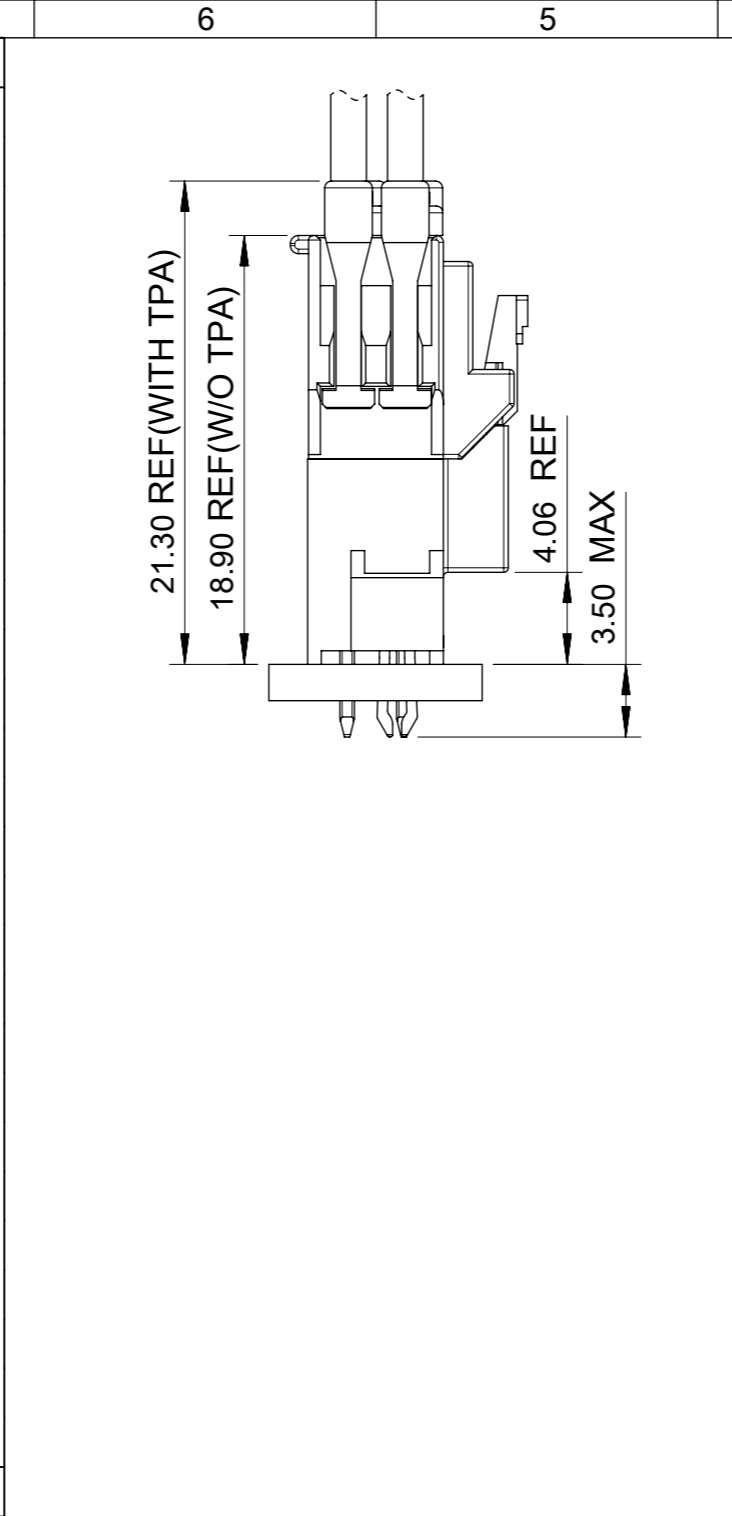

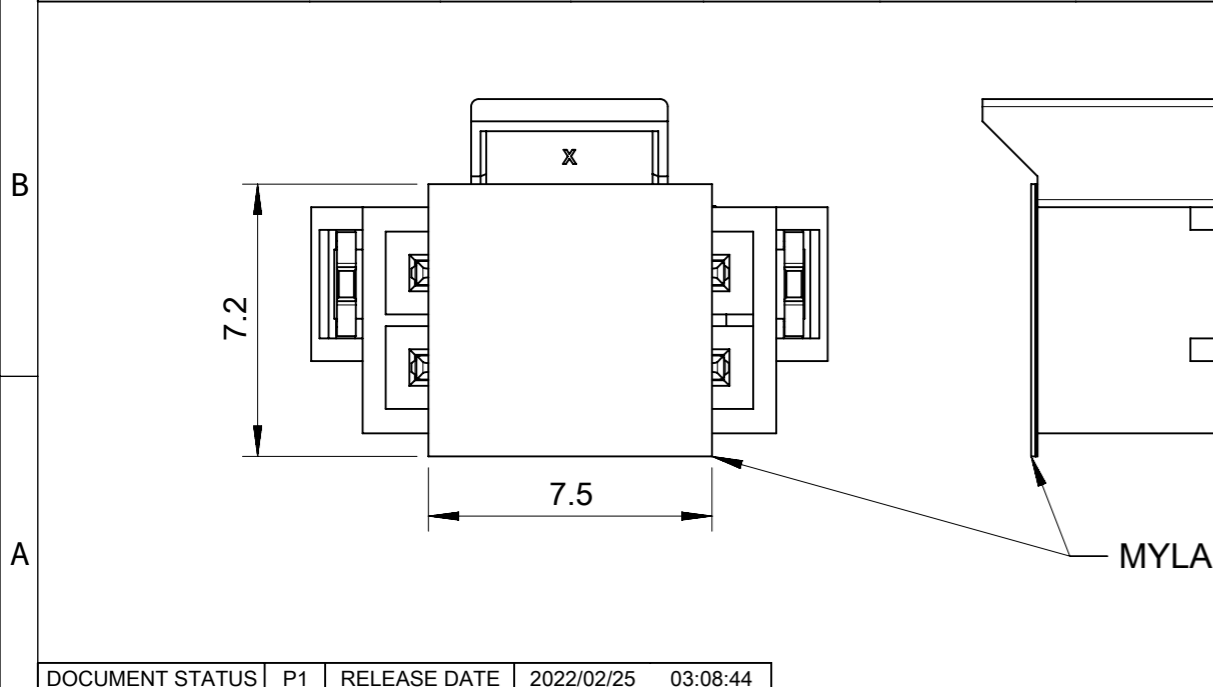

| PART NUMBER | DIM 'A' | DIM 'B' | DIM 'C' | CKT SIZE | PLATING | MYLAR |
|-------------|---------|---------|---------|----------|-----------|-------|
| 105312-4504 | 8.66 | 5.94 | 6.84 | 4 | TIN | |
| 105312-4506 | 11.16 | 8.44 | 9.34 | 6 | | |
| 105312-4508 | 13.66 | 10.94 | 11.84 | 8 | | |
| 105312-4510 | 16.16 | 13.44 | 14.34 | 10 | | |
| 105312-4512 | 18.66 | 15.94 | 16.84 | 12 | | |
| 105312-4514 | 21.16 | 18.44 | 19.34 | 14 | | |
| 105312-4516 | 23.66 | 20.94 | 21.84 | 16 | | |
| 105312-4704 | 8.66 | 5.94 | 6.84 | 4 | | |
| 105312-4706 | 11.16 | 8.44 | 9.34 | 6 | | |
| 105312-4708 | 13.66 | 10.94 | 11.84 | 8 | | |
| 105312-4710 | 16.16 | 13.44 | 14.34 | 10 | | |
| 105312-4712 | 18.66 | 15.94 | 16.84 | 12 | | |
| 105312-4714 | 21.16 | 18.44 | 19.34 | 14 | | |
| 105312-4716 | 23.66 | 20.94 | 21.84 | 16 | | |
| 105312-4604 | 8.66 | 5.94 | 6.84 | 4 | GOLD 0.76 | YES |
| 105312-4606 | 11.16 | 8.44 | 9.34 | 6 | | |
| 105312-4608 | 13.66 | 10.94 | 11.84 | 8 | | |
| 105312-4610 | 16.16 | 13.44 | 14.34 | 10 | | |
| 105312-4612 | 18.66 | 15.94 | 16.84 | 12 | | |
| 105312-4614 | 21.16 | 18.44 | 19.34 | 14 | | |
| 105312-4616 | 23.66 | 20.94 | 21.84 | 16 | | |
| 105312-4804 | 8.66 | 5.94 | 6.84 | 4 | | |
| 105312-4806 | 11.16 | 8.44 | 9.34 | 6 | | |
| 105312-4808 | 13.66 | 10.94 | 11.84 | 8 | | |
| 105312-4810 | 16.16 | 13.44 | 14.34 | 10 | | |
| 105312-4812 | 18.66 | 15.94 | 16.84 | 12 | | |
| 105312-4814 | 21.16 | 18.44 | 19.34 | 14 | | |
| 105312-4816 | 23.66 | 20.94 | 21.84 | 16 | | |

COLOR: NATURAL

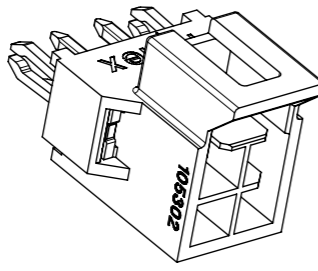
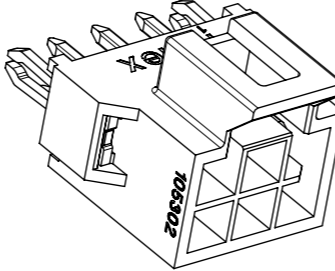
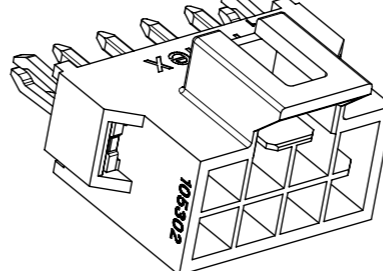
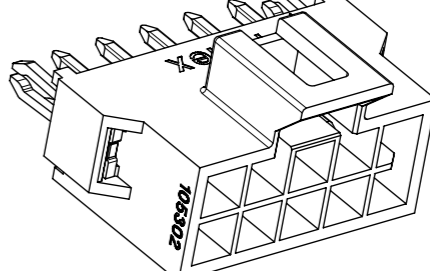
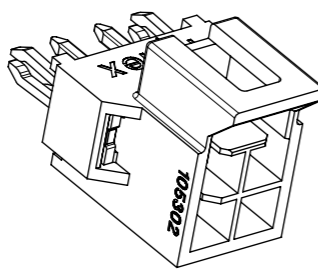
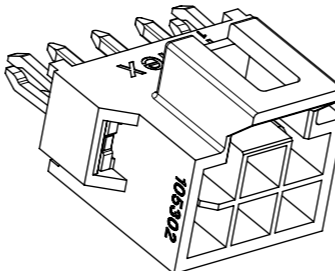
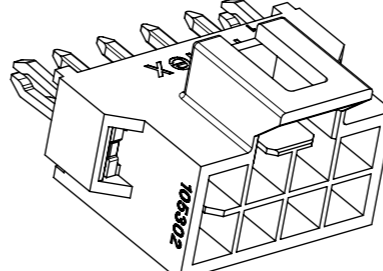
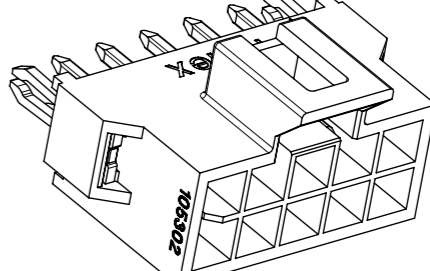
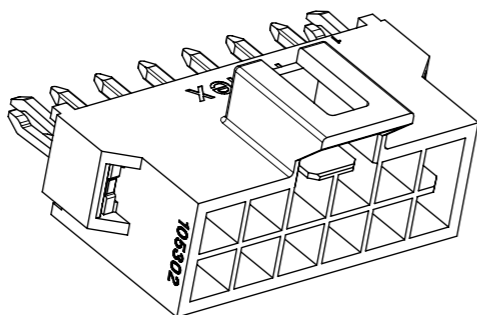
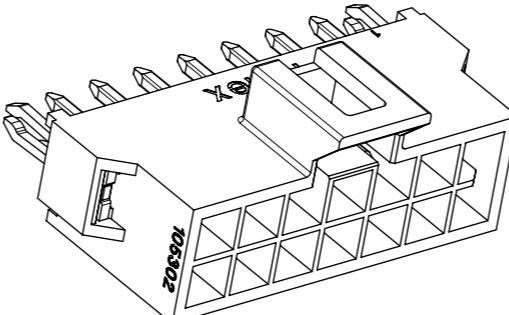
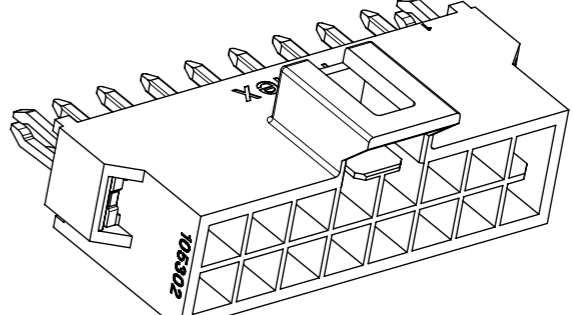
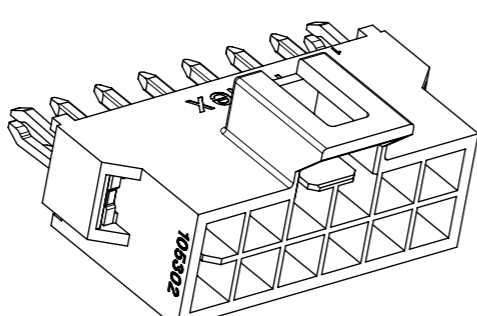
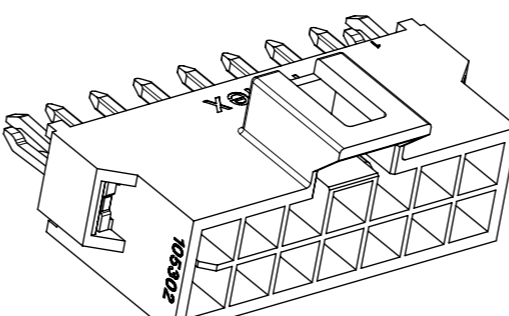
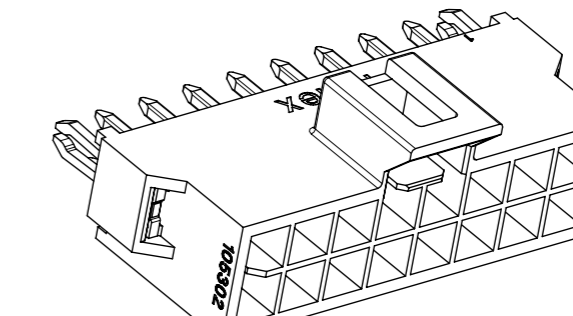

| | | | | | | | | | | | | | | | | | | | | | | | | | | |
|--|--|--------------------------|-----------------|--------------|----------|----------------|----|-----|----------------|---------------------------------------|--|----------------|-----------------------------|--|--------------------|----------|-------|----------|-----------|----------|-----------|---------|-----------|----------|-------|---------------|
| FUNCTIONAL SYMBOLS | THIS DRAWING CONTAINS INFORMATION THAT IS PROPRIETARY TO MOLEX ELECTRONIC TECHNOLOGIES, LLC AND SHOULD NOT BE USED WITHOUT WRITTEN PERMISSION | CURRENT REV DESC: | | molex | | | | | | | | | | | | | | | | | | | | | | |
| | <table border="1"> <tr><td>FUNCTIONAL SYMBOLS</td><td>DIMENSION UNITS</td><td>SCALE</td></tr> <tr><td>$\nabla_A = 0$</td><td>mm</td><td>5:1</td></tr> <tr><td>$\nabla_E = 0$</td><td colspan="2">GENERAL TOLERANCES (UNLESS SPECIFIED)</td></tr> <tr><td>$\nabla_F = 0$</td><td colspan="2">ANGULAR TOL $\pm 3.0^\circ$</td></tr> <tr><td rowspan="5">DIVISIONAL SYMBOLS</td><td>4 PLACES</td><td>\pm</td></tr> <tr><td>3 PLACES</td><td>± 0.1</td></tr> <tr><td>2 PLACES</td><td>± 0.2</td></tr> <tr><td>1 PLACE</td><td>± 0.3</td></tr> <tr><td>0 PLACES</td><td>\pm</td></tr> </table> | FUNCTIONAL SYMBOLS | DIMENSION UNITS | | SCALE | $\nabla_A = 0$ | mm | 5:1 | $\nabla_E = 0$ | GENERAL TOLERANCES (UNLESS SPECIFIED) | | $\nabla_F = 0$ | ANGULAR TOL $\pm 3.0^\circ$ | | DIVISIONAL SYMBOLS | 4 PLACES | \pm | 3 PLACES | ± 0.1 | 2 PLACES | ± 0.2 | 1 PLACE | ± 0.3 | 0 PLACES | \pm | EC NO: 697101 |
| FUNCTIONAL SYMBOLS | DIMENSION UNITS | SCALE | | | | | | | | | | | | | | | | | | | | | | | | |
| $\nabla_A = 0$ | mm | 5:1 | | | | | | | | | | | | | | | | | | | | | | | | |
| $\nabla_E = 0$ | GENERAL TOLERANCES (UNLESS SPECIFIED) | | | | | | | | | | | | | | | | | | | | | | | | | |
| $\nabla_F = 0$ | ANGULAR TOL $\pm 3.0^\circ$ | | | | | | | | | | | | | | | | | | | | | | | | | |
| DIVISIONAL SYMBOLS | 4 PLACES | \pm | | | | | | | | | | | | | | | | | | | | | | | | |
| | 3 PLACES | ± 0.1 | | | | | | | | | | | | | | | | | | | | | | | | |
| | 2 PLACES | ± 0.2 | | | | | | | | | | | | | | | | | | | | | | | | |
| | 1 PLACE | ± 0.3 | | | | | | | | | | | | | | | | | | | | | | | | |
| | 0 PLACES | \pm | | | | | | | | | | | | | | | | | | | | | | | | |
| DRWN: GLLI | 2022/02/25 | PRODUCT CUSTOMER DRAWING | | | | | | | | | | | | | | | | | | | | | | | | |
| APPR: XQZHANG | 2022/02/25 | DOCUMENT NUMBER | DOC TYPE | DOC PART | REVISION | | | | | | | | | | | | | | | | | | | | | |
| INITIAL REVISION: | 2019/09/24 | 1053121000-SD | PSD | 000 | B1 | | | | | | | | | | | | | | | | | | | | | |
| DRWN: GLLI | 2020/03/16 | MATERIAL NUMBER | CUSTOMER | SHEET NUMBER | | | | | | | | | | | | | | | | | | | | | | |
| APPR: YXZHENG | | A3-SIZE | GENERAL MARKET | 3 OF 5 | | | | | | | | | | | | | | | | | | | | | | |
| DRAFT WHERE APPLICABLE MUST REMAIN WITHIN DIMENSIONS | THIRD ANGLE PROJECTION | SERIES | | | | | | | | | | | | | | | | | | | | | | | | |
| | | 105312 | | | | | | | | | | | | | | | | | | | | | | | | |

| | | | | | |
|---|---------|--|---|---|---|
| | | 4 CKT | 6 CKT | 8 CKT | 10 CKT |
| F | BLACK |  |  |  |  |
| E | NATURAL |  |  |  |  |
| | | 12 CKT | 14 CKT | 16 CKT | |
| D | BLACK |  |  |  | |
| C | NATURAL |  |  |  | |

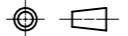
| | | | | | | | | | | |
|---|--|---|--|-----------------------|---------------------------------------|--|--------------------------|----------------------|---------------------|-----------------------------|
| FUNCTIONAL SYMBOLS $\nabla_A = 0$ $\nabla_E = 0$ $\nabla_V = 0$ | THIS DRAWING CONTAINS INFORMATION THAT IS PROPRIETARY TO MOLEX ELECTRONIC TECHNOLOGIES, LLC AND SHOULD NOT BE USED WITHOUT WRITTEN PERMISSION DIMENSION UNITS: mm SCALE: 3:1 | CURRENT REV DESC: EC NO: 697101 DRWN: GLLI CHK'D: XQZHANG APPR: XQZHANG INITIAL REVISION: DRWN: GLLI APPR: YXZHENG |  HEADER OF NANO-FIT, D/R, CLIP, VERTICAL POWER CONNECTOR | | | | | | | |
| | GENERAL TOLERANCES (UNLESS SPECIFIED) ANGULAR TOL $\pm 3.0^\circ$ 4 PLACES \pm 3 PLACES ± 0.1 2 PLACES ± 0.2 1 PLACE ± 0.3 0 PLACES \pm | | | | | 2022/02/24 2022/02/25 2022/02/25 | PRODUCT CUSTOMER DRAWING | | | |
| DIVISIONAL SYMBOLS 4 PLACES \pm 3 PLACES ± 0.1 2 PLACES ± 0.2 1 PLACE ± 0.3 0 PLACES \pm | DRAFT WHERE APPLICABLE MUST REMAIN WITHIN DIMENSIONS | THIRD ANGLE PROJECTION  | DRAWING: A3-SIZE | SERIES: 105312 | MATERIAL NUMBER: 1053121000-SD | CUSTOMER: GENERAL MARKET | DOC TYPE: PSD | DOC PART: 000 | REVISION: B1 | SHEET NUMBER: 4 OF 5 |

NOTES FOR ALL PARTS

1> MATERIAL:
 HOUSING: LCP, UL 94V-0.
 TERMINAL: BRASS.
 SOLDER CLIP: BRASS.

2> PLATING FINISHED:
 TERMINAL:
 CONTACT AREA: a. REFLOW MATTE TIN 1.5MICRONS MIN;
 b. GOLD 0.38 MICRONS MIN;
 c. GOLD 0.76 MICRONS MIN.
 SOLDER AREA: MATTE TIN 1.5 MICRONS MIN, UNDER PLATING NICKEL 1.25
 MICRONS MIN.
 SOLDER CLIP: MATTE TIN 2.5 MICRONS MIN, UNDER PLATING NICKEL 1.25
 MICRONS MIN.

3> PRODUCT SPECIFICATION: PS-105300-100.
 4> PACKAGE: TAPE REEL, 1053121000-PK.
 5> PRODUCT MATE WITH SERIES OF 105308(RECEPTACLE), 105300(CRIMP TERMINAL).
 6> PARTS CONFORM TO CLASS 'B'REQUIREMENTS OF COSMETIC SPECIFICATION
 PS-45499-002.
 7> DISCOLORATION IN THE BANDOLIER PIN CARRIER AREA OF THE PIN IS INHERENT TO
 THE PLATING PROCESS AND IS DUE TO THE MASKING DEFECT OF THE CARRIER, THIS
 DISCOLORATION IS IN A NON-FUNCTION AREA OF THE PIN AND WILL NOT AFFECT
 THE PERFORMANCE OF THE HEADER ASSEMBLY.

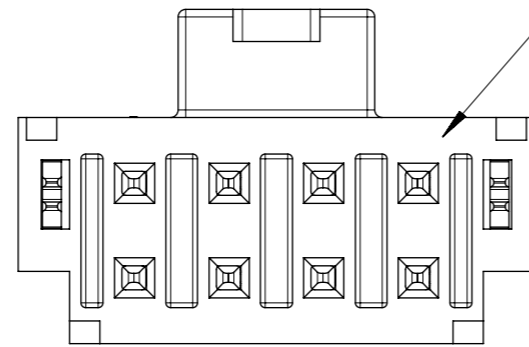

IF ANY NUMBER MARK APPEARS ON THIS SURFACE,
 PLEASE DISREGARD IT, IT IS NO ANY FUCTION AND
 NO ANY RELATION TO PIN NUMBER, IT IS JUST FOR
 MOLDING IDENDIFICATION.

| | | | | | | | | | | |
|--------------------|---|--|---|------------------------|---|--------|-----------------|----------|--------------|----------|
| FUNCTIONAL SYMBOLS | THIS DRAWING CONTAINS INFORMATION THAT IS PROPRIETARY TO MOLEX ELECTRONIC TECHNOLOGIES, LLC AND SHOULD NOT BE USED WITHOUT WRITTEN PERMISSION | | CURRENT REV DESC: | | molex | | | | | |
| | △/A = 0 | mm | | | | | | | SCALE 1:1 | |
| DIVISIONAL SYMBOLS | GENERAL TOLERANCES (UNLESS SPECIFIED) | | EC NO: 697101 DRWN: GLLI 2022/02/24 CHK'D: XQZHANG 2022/02/25 APPR: XQZHANG 2022/02/25 | | HEADER OF NANO-FIT, D/R, CLIP, VERTICAL POWER CONNECTOR | | | | | |
| | △/E = 0 | ANGULAR TOL ± 3.0° | | | PRODUCT CUSTOMER DRAWING | | | | | |
| | △/F = 0 | 4 PLACES ± | | | INITIAL REVISION: | | DOCUMENT NUMBER | DOC TYPE | DOC PART | REVISION |
| | | 3 PLACES ± 0.1 | | | DRWN: GLLI 2019/09/24 | | 1053121000-SD | PSD | 000 | B1 |
| | | 2 PLACES ± 0.2 | | | APPR: YXZHENG 2020/03/16 | | | | | |
| | 1 PLACE ± 0.3 | DRAFT WHERE APPLICABLE MUST REMAIN WITHIN DIMENSIONS | | THIRD ANGLE PROJECTION | DRAWING | SERIES | MATERIAL NUMBER | CUSTOMER | SHEET NUMBER | |
| | 0 PLACES ± | A3-SIZE | | 105312 | | | GENERAL MARKET | 5 OF 5 | | |