

CGS74C2525 • CGS74CT2525 CGS74C2526 • CGS74CT2526 1-to-8 Minimum Skew Clock Driver

The CGS 'C/CT2525 is a minimum skew clock driver with one input driving eight outputs specifically designed for signal generation and clock distribution applications. The '2525 is designed to distribute a single clock to eight separate receivers with low skew across all outputs during both the t_{PLH} and t_{PHL} transitions. The '2526 is similar to the '2525 but contains a multiplexed clock input to allow for systems with dual clock speeds or systems where a separate test clock has been implemented.

Features

- These CGS devices implement National's FACT™ family
- Ideal for signal generation and clock distribution
- Guaranteed pin to pin and part to part skew
- Multiplexed clock input ('2526)
- Guaranteed 2 kV minimum ESD protection
- Symmetric output current drive of 24 mA for I_{OL}/I_{OH}
- 'CT has TTL-compatible inputs
- These products are identical to 74AC/ACT2525 and 2526
- Available as Mil/Aero versions
54AC/ACT2525
54AC/ACT2526

Ordering Code: See Section 5

Logic Symbols

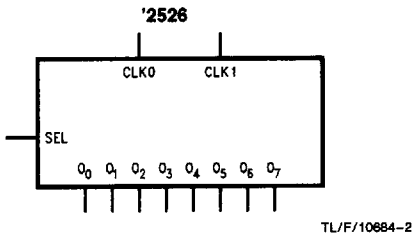
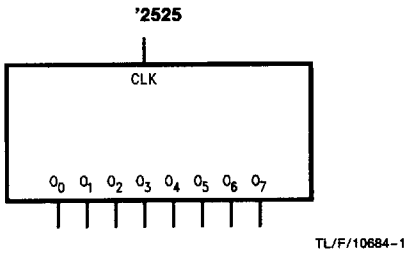

Connection Diagrams

Pin Assignment for DIP and SOIC

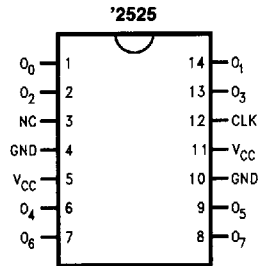

TL/F/10684-3

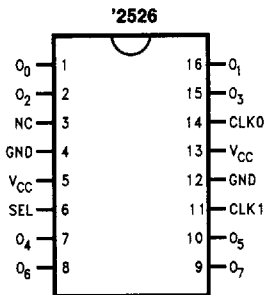

TL/F/10684-4

Functional Description

On the multiplexed clock device, the SEL pin is used to determine which CLKn input will have an active effect on the outputs of the circuit. When SEL = 1, the CLK1 input is selected and when SEL = 0, the CLK0 input is selected. The non-selected CLKn input will not have any effect on the logical output level of the circuit. The output pins act as a single entity and will follow the state of the CLK or CLK1/CLK0 pins when either the multiplexed ('2526) or the straight ('2525) clock distribution chip is selected.

Pin Description

Pin Names	Description
CLK	Clock Input ('2525)
CLK0, CLK1	Clock Inputs ('2526)
O ₀ -O ₇	Outputs
SEL	Clock Select ('2526)

Truth Tables

'2525

Inputs		Outputs	
CLK		O ₀ -O ₇	
L		L	
H		H	

'2526

Inputs			Outputs	
CLK0	CLK1	SEL	O ₀ -O ₇	
L	X	L	L	
H	X	L	H	
X	L	H	L	
X	H	H	H	

L = Low Voltage Level
 H = High Voltage Level
 X = Immaterial

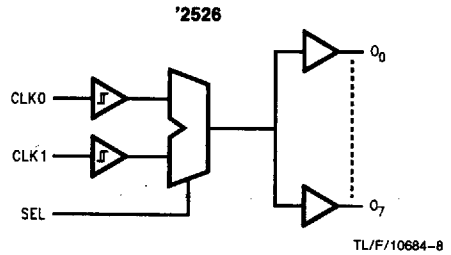
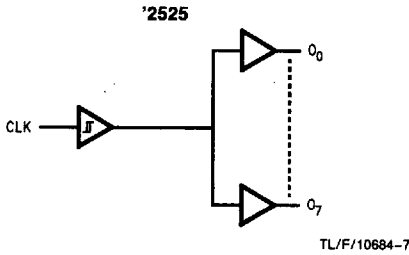

Absolute Maximum Ratings (Note 1)

If Military/Aerospace specified devices are required, please contact the National Semiconductor Sales Office/Distributors for availability and specifications.

Supply Voltage (V_{CC})	-0.5V to +7.0V
DC Input Diode Current (I_{IK})	
$V_I = -0.5V$	-20 mA
$V_I = V_{CC} + 0.5V$	+0.2 mA
DC Input Voltage (V_I)	-0.5V to ($V_{CC} + 0.5V$)
DC Output Diode Current (I_{OK})	
$V_O = 0.5V$	-20 mA
$V_O = V_{CC} + 0.5V$	+20 mA
DC Output Voltage (V_O)	-0.5V to ($V_{CC} + 0.5V$)
DC Output Source or Sink Current (I_O)	± 50 mA
DC V_{CC} or Ground Current per Output Pin (I_{CC} or I_{GND})	± 50 mA
Storage Temperature (T_{STG})	-65°C to +150°C
Junction Temperature (θ_{JA})	
Plastic (N) 14-Lead	102°C/W
Plastic (M) 14-Lead	128°C/W
Plastic (N) 16-Lead	97°C/W
Plastic (M) 16-Lead	124°C/W

Recommended Operating Conditions

Supply Voltage (V_{CC})	2.0V to 6.0V
'C'	4.5V to 5.5V
'CT'	
Input Voltage (V_I)	0V to V_{CC}
Output Voltage (V_O)	0V to V_{CC}
Operating Temperature (T_A)	
CGS74C/CT	-40°C to +85°C
54AC/ACT	-55°C to +125°C
Input Rise and Fall Times Devices (30% to 70% of V_{CC})	
$V_{CC} = 3.3V$	10.5 ns max
4.5V	14.4 ns max
5.5V	17.6 ns max
Input Rise and Fall Times Devices (0.8V to 2.0V)	9.6 ns max

Note 1: Absolute maximum ratings are those values beyond which damage to the device may occur. The databook specifications should be met, without exception, to ensure that the system design is reliable over its power supply, temperature, and output/input loading variables. National does not recommend operation of CGS circuits outside databook specifications.

DC Electrical Characteristics for CGS74C and 54AC Family Devices

Over recommended operating conditions unless specified otherwise.

Symbol	Parameter	V_{CC} (V)	CGS74C		54AC	CGS74C		Units	Conditions
			$T_A = +25^\circ C$		$T_A = -55^\circ C$ to $+125^\circ C$	$T_A = -40^\circ C$ to $+85^\circ C$			
			Typ	Guaranteed Limits					
V_{IH}	Minimum High Level Input Voltage	3.0	1.5	2.1	2.1	2.1	2.1	V	$V_{OUT} = 0.1V$ or $V_{CC} - 0.1V$
		4.5	2.25	3.15	3.15	3.15	3.15		
		5.5	2.75	3.85	3.85	3.85	3.85		
V_{IL}	Maximum Low Level Input Voltage	3.0	1.5	0.9	0.9	0.9	0.9	V	$V_{OUT} = 0.1V$ or $V_{CC} - 0.1V$
		4.5	2.25	1.35	1.35	1.35	1.35		
		5.5	2.75	1.65	1.65	1.65	1.65		
V_{OH}	Minimum High Level Output Voltage (Note 2)	3.0	2.99	2.9	2.9	2.9	2.9	V	$I_{OUT} = -50 \mu A$
		4.5	4.49	4.4	4.4	4.4	4.4		
		5.5	5.49	5.4	5.4	5.4	5.4		
		3.0		2.56	2.4	2.46		V	$V_{IN} = V_{IL}$ or V_{IH} -12 mA $I_{OH} = -24$ mA -24 mA
		4.5		3.86	3.7	3.76			
		5.5		4.86	4.7	4.76			
V_{OL}	Maximum Low Level Output Voltage (Note 2)	3.0	0.002	0.1	0.1	0.1	0.1	V	$I_{OUT} = 50 \mu A$
		4.5	0.001	0.1	0.1	0.1	0.1		
		5.5	0.001	0.1	0.1	0.1	0.1		
		3.0		0.36	0.40	0.44		V	$V_{IN} = V_{IL}$ or V_{IH} 12 mA $I_{OL} = 24$ mA 24 mA
		4.5		0.36	0.50	0.44			
		5.5		0.36	0.50	0.44			

DC Electrical Characteristics for CGS74C and 54AC Family Devices (Continued)

Over recommended operating conditions unless specified otherwise.

Symbol	Parameter	V _{CC} (V)	CGS74C		54AC	CGS74C		Units	Conditions
			T _A = +25°C		T _A = -55°C to +125°C	T _A = -40°C to +85°C			
			Typ	Guaranteed Limits					
I _{IN}	Maximum Input Leakage Current (Note 3)	5.5		±0.1	±1.0	±1.0		μA	V _I = V _{CC} , GND
I _{OLD}	Minimum Dynamic Output Current (Note 4)	5.5			50	75		mA	V _{OLD} = 1.65V Max
I _{OHD}		5.5			-50	-75		mA	V _{OHD} = 3.85V Min
I _{CC}	Maximum Quiescent Supply Current (Note 3)	5.5		8.0	80.0	80.0		μA	V _{IN} = V _{CC} or GND

DC Electrical Characteristics for CGS74CT and 54ACT Family Devices

Over recommended operating conditions unless specified otherwise.

Symbol	Parameter	V _{CC} (V)	CGS74CT		54ACT	CGS74CT		Units	Conditions
			T _A = +25°C		T _A = -55°C to +125°C	T _A = -40°C to +85°C			
			Typ	Guaranteed Limits					
V _{IH}	Minimum High Level Input Voltage	4.5	1.5	2.0	2.0	2.0		V	V _{OUT} = 0.1V or V _{CC} - 0.1V
		5.5	1.5	2.0	2.0	2.0			
V _{IL}	Maximum Low Level Input Voltage	4.5	1.5	0.8	0.8	0.8		V	V _{OUT} = 0.1V or V _{CC} - 0.1V
		5.5	1.5	0.8	0.8	0.8			
V _{OH}	Minimum High Level Output Voltage (Note 2)	4.5	4.49	4.4	4.4	4.4		V	I _{OUT} = -50 μA
		5.5	5.49	5.4	5.4	5.4			
		4.5		3.86	3.70	3.76			
		5.5		4.86	4.70	4.76			
V _{OL}	Maximum Low Level Output Voltage (Note 2)	4.5	0.001	0.1	0.1	0.1		V	I _{OUT} = 50 μA
		5.5	0.001	0.1	0.1	0.1			
		4.5		0.36	0.50	0.44			
		5.5		0.36	0.50	0.44			
I _{IN}	Maximum Input Leakage Current	5.5		±0.1	±1.0	±1.0		μA	V _I = V _{CC} , GND
I _{CT}	Maximum I _{CC} /Input	5.5	0.6		1.6	1.5		mA	V _I = V _{CC} - 2.1V
I _{OLD}	Minimum Dynamic Output Current (Note 4)	5.5			50	75		mA	V _{OLD} = 1.65V Max
I _{OHD}		5.5			-50	-75		mA	V _{OHD} = 3.85V Min
I _{CC}	Maximum Quiescent Supply Current (Note 5)	5.5		8.0	160.0	80.0		μA	V _{IN} = V _{CC} or GND

CGS74C2525 • CGS74CT2525 • CGS74C2526 • CGS74CT2526

AC Electrical Characteristics Over recommended operating conditions unless specified otherwise.

Symbol	Parameter	V _{CC} Range (V) (Note 6)	CGS74C			54AC		CGS74C			Units
			T _A = +25°C C _L = 50 pF			T _A = -55°C to +125°C C _L = 50 pF		T _A = -40°C to +85°C C _L = 50 pF			
			Min	Typ	Max	Min	Max	Min	Typ	Max	
t _{PLH} , t _{PHL}	Propagation Delay CLK to O _n ('2525)	3.3 5.0	3.0 3.2	6.5 5.0	11.0 7.8	3.0 2.5	11.0 8.2	3.0 2.9	12.5 8.1	ns	
t _{PLH} , t _{PHL}	Propagation Delay CLK _n to O _n ('2526)	3.3 5.0	3.0 3.6	7.0 5.5	13.0 7.8			3.0 3.3	14.0 8.6	ns	
t _{PLH} , t _{PHL}	Propagation Delay SEL to O _n ('2526)	3.3 5.0	3.0 4.0	8.0 6.5	14.0 8.5			3.0 3.5	15.0 9.5	ns	
t _{OSHL}	Maximum Skew Common Edge Output-to-Output (Note 7) Variation	3.3 5.0		0.3 0.2			1.5 1.0		600 500	ps	
t _{OSLH}	Maximum Skew Common Edge Output-to-Output (Note 7) Variation	3.3 5.0		0.3 0.2			1.5 1.0		600 500	ps	
t _{OST}	Maximum Skew Opposite Edge Output-to-Output (Note 7) Variation	5.0		0.4	1.0		1.5 1.0		1.0	ns	
t _{PV}	Maximum Skew Part-to-Part Variation (Note 8)	'C2525									ns
		'CT2525	5.0			3.5		4.0			
		'C2526	5.0			5.0					
t _{rise} , t _{fall}	Maximum Rise/Fall Time (20% to 80% V _{CC})	5.0				3.0		4.0		3.75	ns
t _{rise} , t _{fall}	Maximum Rise/Fall Time (0.8V/2.0V and 2.0V/0.8V)					0.9				1.1	ns

AC Electrical Characteristics Over recommended operating conditions unless specified otherwise.

Symbol	Parameter	V _{CC} Range (V) (Note 6)	CGS74CT			54ACT		CGS74CT		Units
			T _A = +25°C C _L = 50 pF			T _A = -55°C to +125°C C _L = 50 pF		T _A = -40°C to +85°C C _L = 50 pF		
			Min	Typ	Max	Min	Max	Min	Max	
t _{PLH} , t _{PHL}	Propagation Delay CLK to O _n ('2525)	5.0	4.6	6.5	9.0			4.0	10.1	ns
t _{PLH} , t _{PHL}	Propagation Delay CLK _n to O _n ('2526)	5.0	5.8	8.5	11.1			5.1	12.4	ns

AC Electrical Characteristics

Over recommended operating conditions unless specified otherwise. (Continued)

Symbol	Parameter	V _{CC} Range (V) (Note 6)	CGS74CT			54ACT		CGS74CT			Units
			T _A = +25°C C _L = 50 pF			T _A = -55°C to +125°C C _L = 50 pF		T _A = -40°C to +85°C C _L = 50 pF			
			Min	Typ	Max	Min	Max	Min	Typ	Max	
t _{PLH} , t _{PHL}	Propagation Delay SEL to O _n (*2526)	5.0	5.1	8.5	12.4			4.4	14.1	ns	
t _{OSHL}	Maximum Skew Common Edge Output-to-Output (Note 7) Variation	5.0		0.2					550	ps	
t _{OSLH}	Maximum Skew Common Edge Output-to-Output (Note 7) Variation	5.0		0.2					550	ps	
t _{OST}	Maximum Skew Opposite Edge Output-to-Output (Note 7) Variation	5.0		0.4					1.0	ns	
t _{pv}	Maximum Skew Part-to-Part Variation (Note 8)	AC2525 ACT2525 AC2526	5.0		3.5						ns
		ACT2526	5.0		5.0						ns
t _{rise} , t _{fall}	Maximum Rise/Fall Time (20% to 80% V _{CC})	5.0		3.0					3.75	ns	
t _{rise} , t _{fall}	Maximum Rise/Fall Time (0.8V/2.0V and 2.0V/0.8V)			0.9					1.1	ns	

Note 2: All outputs loaded; thresholds on input associated with output under test.

Note 3: I_{IN} and I_{CC} @ 3.0V are guaranteed to be less than or equal to the respective limit @ 5.5V V_{CC}.
I_{CC} for 54AC @ 25°C is identical to CGS74C @ 25°C.

Note 4: Maximum test duration 2.0 ms, one output loaded at a time.

Note 5: I_{CC} for 54ACT @ 25°C is identical to CGS74CT @ 25°C.

Note 6: Voltage Range 5.0 is 5.0V ± 0.5V, voltage range 3.3 is 3.3V ± 0.3V.

Note 7: Output-to-Output Skew is defined as the absolute value of the difference between the actual propagation delay for any outputs within the same packaged device. The specifications apply to any outputs switching in the same direction either HIGH to LOW (t_{OSHL}) or LOW to HIGH (t_{OSLH}) or in opposite directions both HL and LH (t_{OST}). t_{OSHL} and t_{OSLH} are characterized and guaranteed by design @ 1 MHz.

Note 8: Part-to-part skew is defined as the absolute value of the difference between the propagation delay for any outputs from device to device. The parameter is specified for a given set of conditions (i.e., capacitive load, V_{CC}, temperature, # of outputs switching, etc.). Parameter guaranteed by design.

Note 9: Load capacitance includes the test jig.

Capacitance

Symbol	Parameter	Typ	Units	Conditions
C _{IN}	Input Capacitance	4.5	pF	V _{CC} = 5.0V
C _{PD}	Power Dissipation Capacitance (*2525)	820 pF - 1.2 × 10 ⁻¹⁸ (f)*	pF	V _{CC} = 5.0V
C _{PD}	Power Dissipation Capacitance (*2526)	820 pF - 1.2 × 10 ⁻¹⁸ (f)*	pF	V _{CC} = 5.0V

*f = frequency

Recommended Maximum Power Dissipation (W)

LFPM	T _A = 25°C		T _A = 85°C	
	PDIP	SOIC	PDIP	SOIC
0	1.105	0.858	0.528	0.41
225	1.493	1.055	0.714	0.504
500	1.71	1.210	0.820	0.578

Timing Diagrams

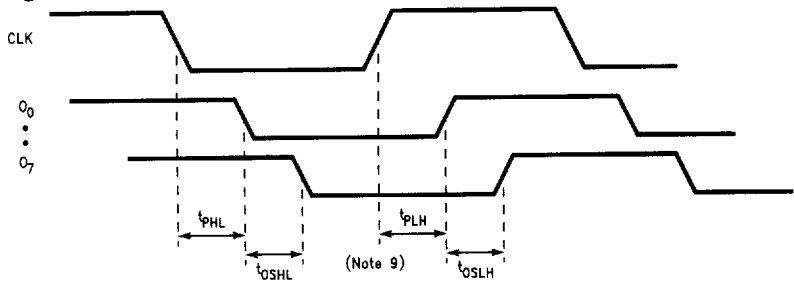

TL/F/10684-27

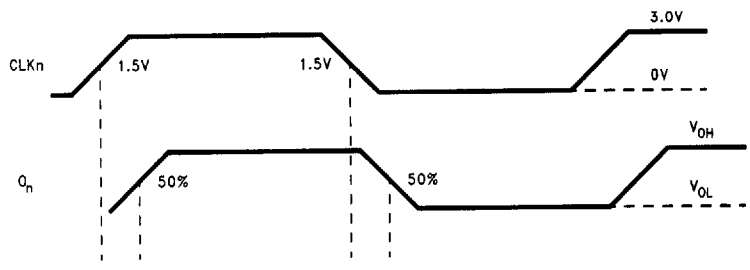

TL/F/10684-28

Test Circuit

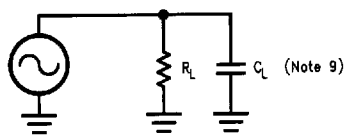

R_L is 500Ω
C_L is 50 pF for all prop delays and skew measurements.

TL/F/10684-29

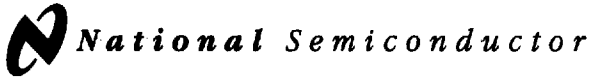

8 Lead (0.150" Wide) Molded Small Outline Package, JEDEC NS Package Number M08A

All dimensions are in inches (millimeters)

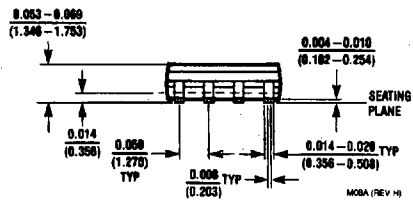
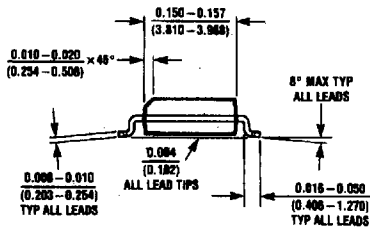
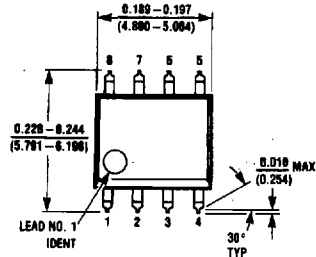

M08A (REV H)

14 Lead (0.150" Wide) Molded Small Outline Package, JEDEC NS Package Number M14A

All dimensions are in inches (millimeters)

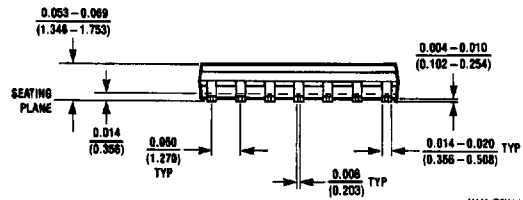
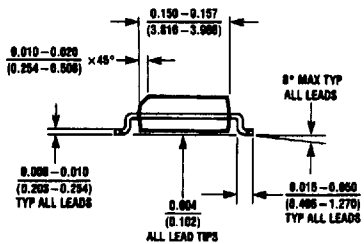
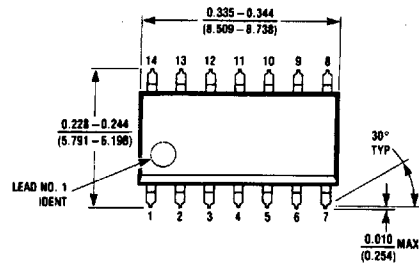

M14A (REV H)

16 Lead (0.150" Wide) Molded Small Outline Package, JEDEC NS Package Number M16A

All dimensions are in inches (millimeters)

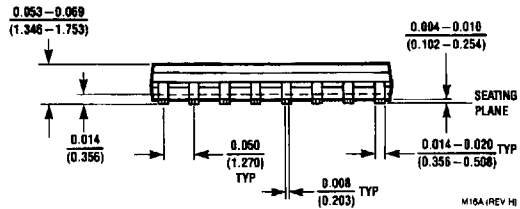
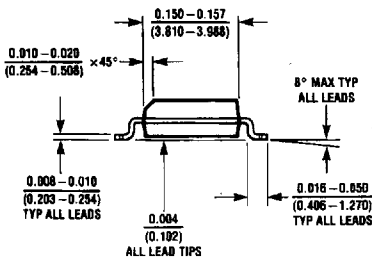
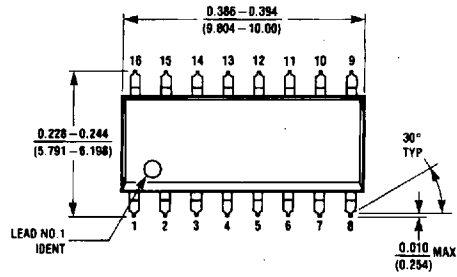

M16A (REV B)

20 Lead (0.300" Wide) Molded Small Outline Package, JEDEC NS Package Number M20B

All dimensions are in inches (millimeters)

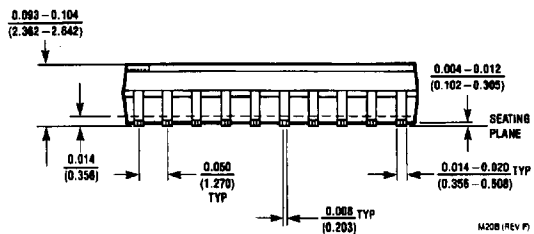
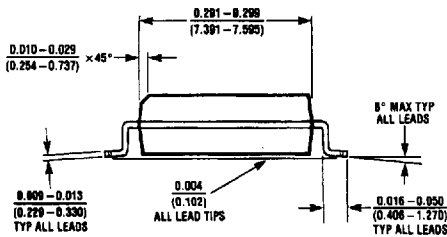
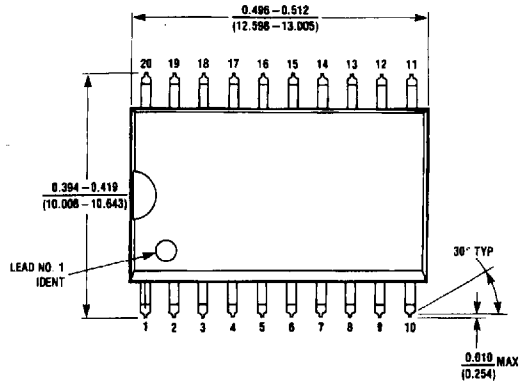

M20B (REV F)

28 Lead (0.300" Wide) Molded Small Outline Package, JEDEC NS Package Number M28B

All dimensions are in inches (millimeters)

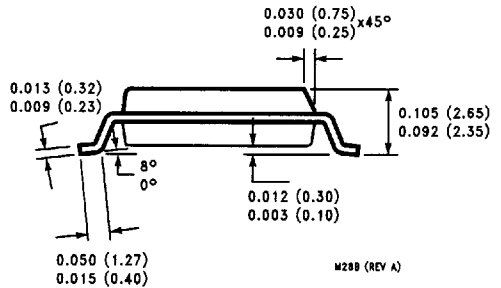
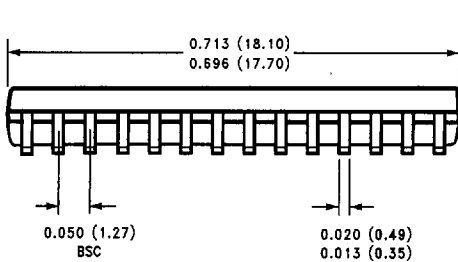
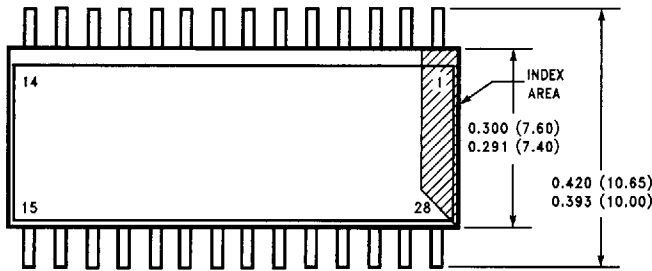

14 Lead (0.300" Wide) Molded Dual-in-Line Package NS Package Number N14A

All dimensions are in inches (millimeters)

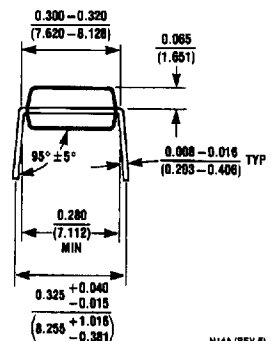
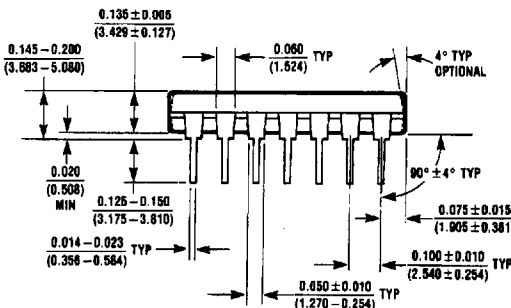
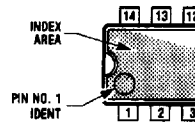
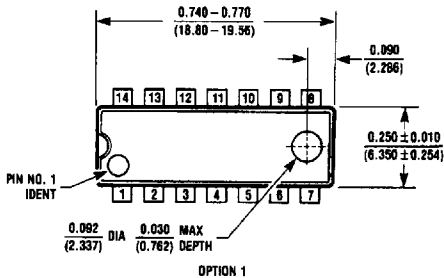

N14A (REV F)

16 Lead (0.300" Wide) Molded Dual-in-Line Package NS Package Number N16E

All dimensions are in inches (millimeters)

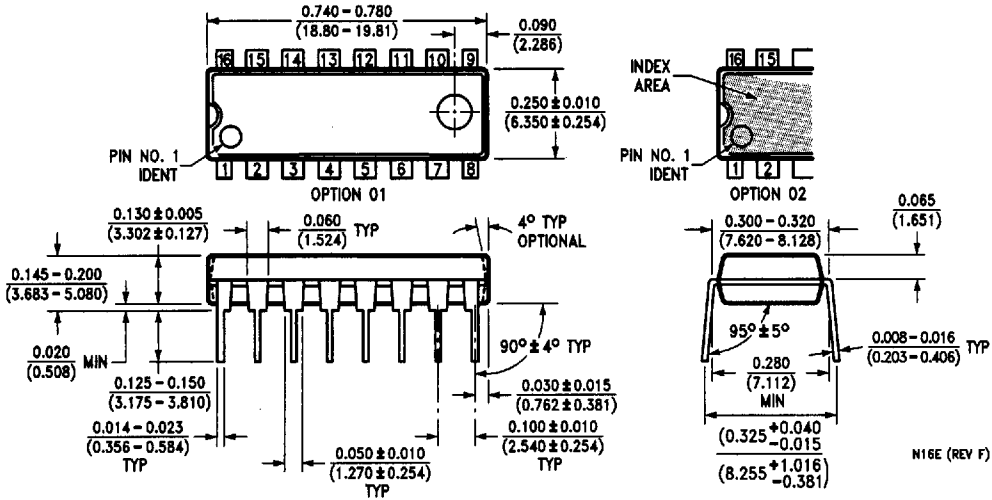

20 Lead (0.300" Wide) Molded Dual-in-Line Package NS Package Number N20A

All dimensions are in inches (millimeters)

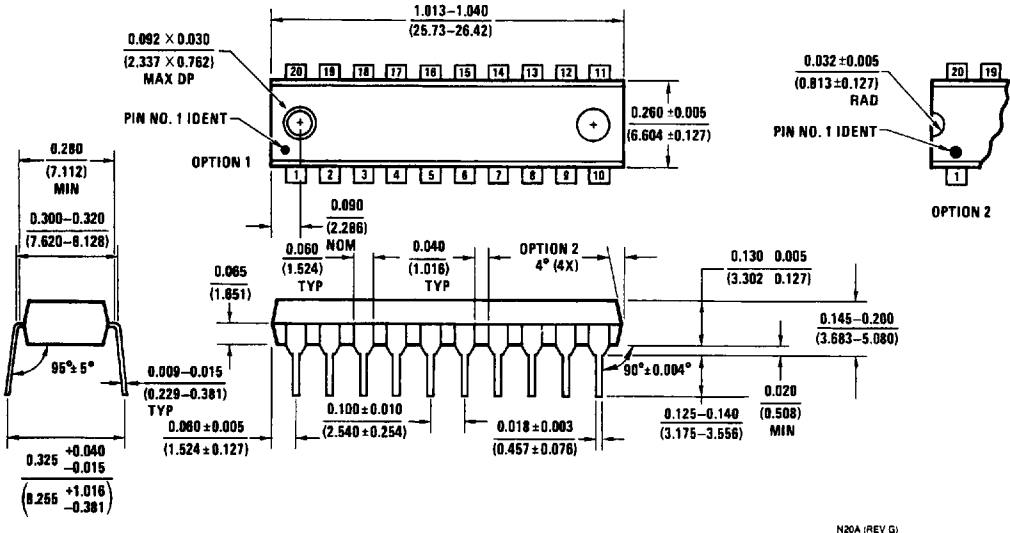

28 Lead Molded Plastic Leaded Chip Carrier NS Package Number V28A

All dimensions are in inches [millimeters]

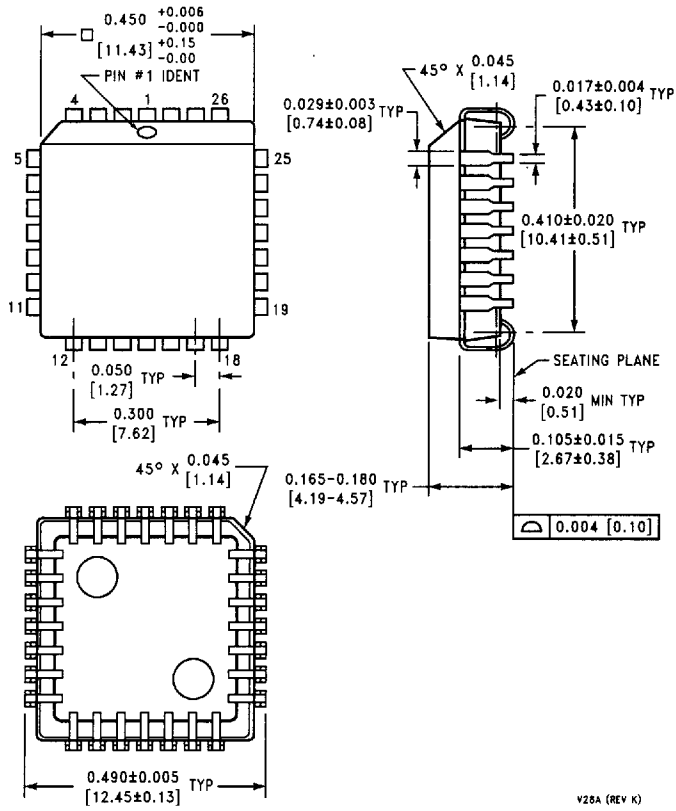

V28A (REV K)