

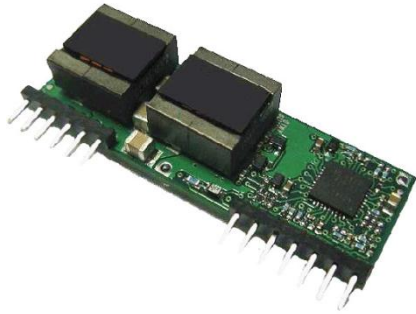

## 45A NCT Point-of-Load Converter



### Features

- High efficiency, 93% (12V Input 3.3V/45A )
- Excellent thermal performance
- Over-voltage, over-current, short-circuit, and over temperature protection
- Monotonic start-up into pre-biased load
- UL 60950-1 2<sup>nd</sup> edition recognized

### Options

- Baseplate
- Negative / Positive enable logic
- Frequency synchronization, Sense-, or Power good
- Output voltage tracking/sequence

### Part Numbering System

NCT	1	□□□	□	045	□	□	□	□
Series Name:	Input Voltage:	Output Voltage:	Enabling Logic:	Rated Output Current:	Pin Length Options:	Electrical Option1:	Mechanical Options (ROHS-6 Compliant)	Electrical Option2:
NCT	1: 8-16V	000: variable (0.8-5V)	P: positive N: negative	Unit: A 045:45A	H: horizontal (0.18") R: vertical (0.13") T: vertical (0.17")	0:None 1:Output tracking	5: open frame 6: baseplate	0: None 1:freq synch. 2: power good 3: Sense-

## Absolute Maximum Ratings

Excessive stresses over these absolute maximum ratings can cause permanent damage to the converter. Operation should be limited to the conditions outlined under the Electrical Specification Section.

Parameter	Symbol	Min	Max	Unit
Input Voltage (continuous)	$V_i$	-0.5	20	Vdc
Operating Ambient Temperature (See Thermal Consideration section)	$T_o$	-40	85*	°C
Storage Temperature	$T_{stg}$	-55	125	°C

\* Derating curves provided in this datasheet end at 85°C ambient temperature. Operation above 85°C ambient temperature is allowed provided the temperatures of the key components or the baseplate do not exceed the limit stated in the Thermal Considerations section.

## Electrical Specifications

These specifications are valid over the converter's full range of input voltage, resistive load, and operating temperature unless noted otherwise.

### Input Specifications

Parameter	Symbol	Min	Typical	Max	Unit
Input Voltage	$V_i$	8	12	16	Vdc
Input Current	$I_{in\_Max}$	-	-	35	A
Quiescent Input Current (Typical $V_{in}$ )	$I_{in\_Qsnt}$	-	220	280	mA
Standby Input Current	$I_{in\_Stdby}$	-	22	-	mA
Input Reflected-ripple Current, Peak-to-peak (5 Hz to 20 MHz, 12 $\mu$ H source impedance)	-	-	20	-	mA <sub>p-p</sub>
Input Ripple Rejection (120 Hz)	-	-	30	-	dB
Input Turn-on Voltage Threshold	-	-	7.5	8	V

### Output Specifications

Parameter	Symbol	Min	Typical	Max	Unit
Output Voltage Set Point Accuracy ( $V_i$ = Typical $V_{in}$ ; $I_o$ = $I_{o,max}$ ; $T_a$ = 25°C)	-	-2.0	-	+2.0	%
Output Voltage Set Point Accuracy (over all conditions)	-	-2.5	-	+3.5	%
Output Regulation:					
Line Regulation (full range input voltage, 1/2 full load)	-	-	0.2	-	% $V_o$
Load Regulation (full range load, Typical $V_{in}$ )	-	-	0.3	-	% $V_o$
Temperature ( $T_a$ = -40°C to 85 °C)	-	-	0.2	-	% $V_o$
Output Ripple and Noise Voltage					
RMS	-	-	-	1	% $V_o$
Peak-to-peak (5 Hz to 20 MHz bandwidth, Typical $V_{in}$ )	-	-	1.5	-	% $V_o$
External Load Capacitance	-	-	-	33,000	$\mu$ F
Output Current	$I_o$	0	-	45	A
Output Current-limit Trip Point ( $V_o$ = 90% of $V_{o,nom}$ )	$I_{o,cli}$	-	65	-	A
Efficiency (Typical $V_{in}$ ; $I_{o,max}$ , $T_A$ = 25°C)	$V_o=0.8V$	$\eta$	83	-	%
	$V_o=1V$		85	-	
	$V_o=1.2V$		86.5	-	
	$V_o=1.5V$		88.3	-	
	$V_o=1.8V$		89	-	
	$V_o=2.5V$		91	-	
	$V_o=3.3V$		93	-	
$V_o=5V$	95	-			
Output Over Voltage trip point	-	-	116	-	% $V_{onom}$
Output Ripple Frequency	-	240	270	300	kHz
PGOOD Source Current	-	-	-	0.1	mA
PGOOD low level voltage	-	0	0.35	0.4	V
PGOOD high level voltage	-	4.5	5	5.5	V
PGOOD delay(from $V_o$ reaches regulation point)	-	-	5	-	mS



## Output Specifications (continued)

Parameter	Symbol	Min	Typical	Max	Unit
Dynamic Response (Vi = Typical Vin; Ta = 25°C; Load transient 0.1A/μs)					
Load steps from 50% to 75% of full load:					
Peak deviation			200		mV
Settling time (within 10% band of Vo deviation)			250		μs
Load step from 50% to 25% of full load					
Peak deviation			200		mV
Settling time (within 10% band of Vo deviation)			250		μs

## General Specifications

Parameter	Symbol	Min	Typical	Max	Unit
Remote Enable					
Logic Low:					
ION/OFF = 1.0mA	VON/OFF	0	-	0.5	V
VON/OFF = 0.0V	ION/OFF	-	-	1.0	mA
Logic High:					
ION/OFF = 0.0μA	VON/OFF	-	-	Vin, max	V
Leakage Current	ION/OFF	-	-	50	μA
Calculated MTBF (Telecordia SR-332, 2011, Issue 3), full load, 40°C, 60% upper confidence level, typical Vin			9.8		10 <sup>6</sup> -hour

## Characteristic Curves

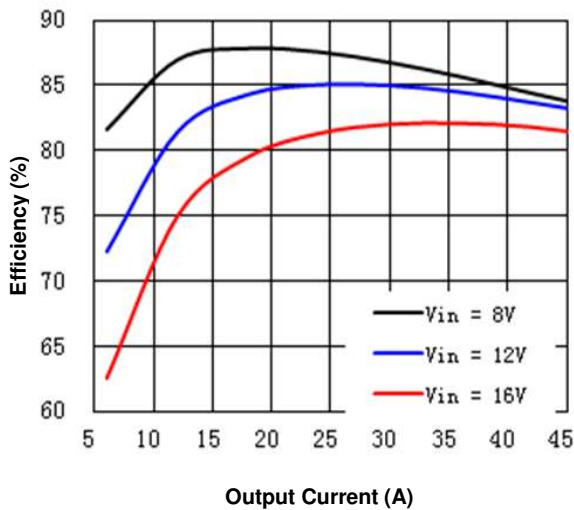

Figure 1(a). Efficiency vs. Load Current (25°C, 0.8V)

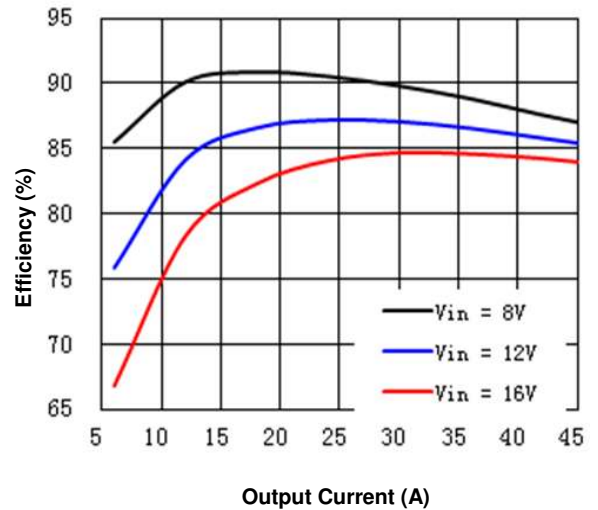

Figure 1(b). Efficiency vs. Load Current (25°C, 1.0V)

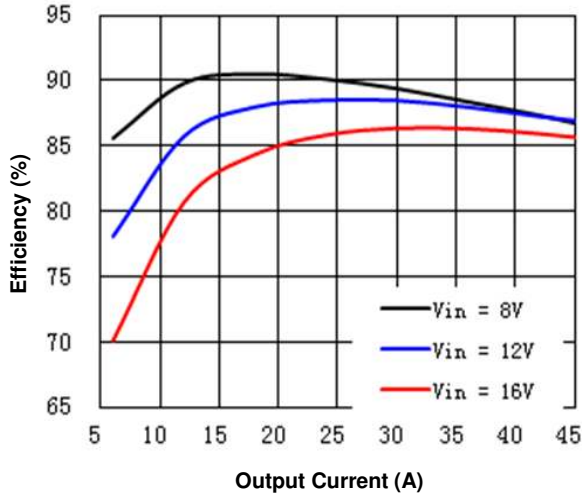

Figure 1(c). Efficiency vs. Load Current (25°C, 1.2V)

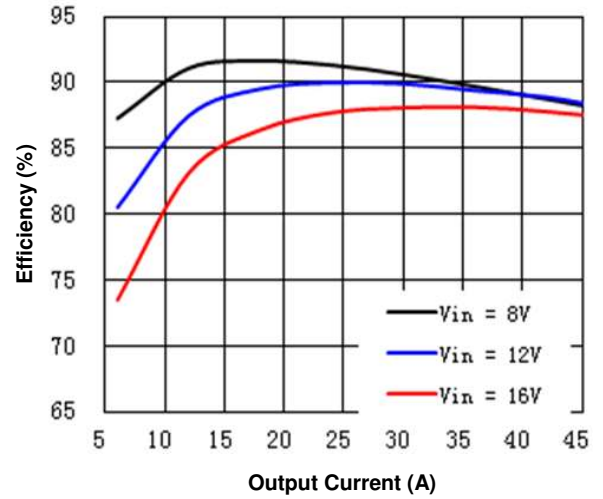

Figure 1(d). Efficiency vs. Load Current (25°C, 1.5V)

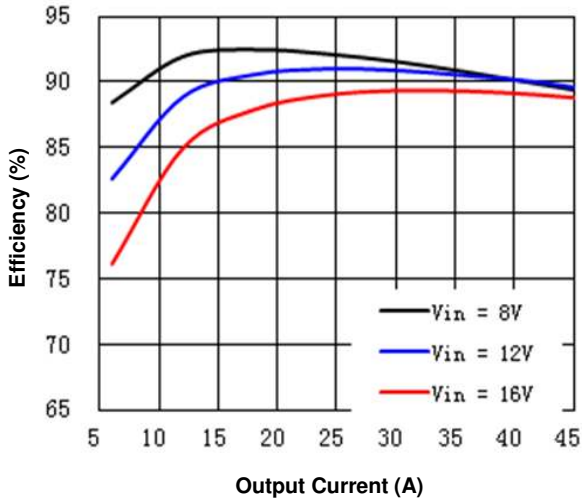

Figure 1(e). Efficiency vs. Load Current (25°C, 1.8V)

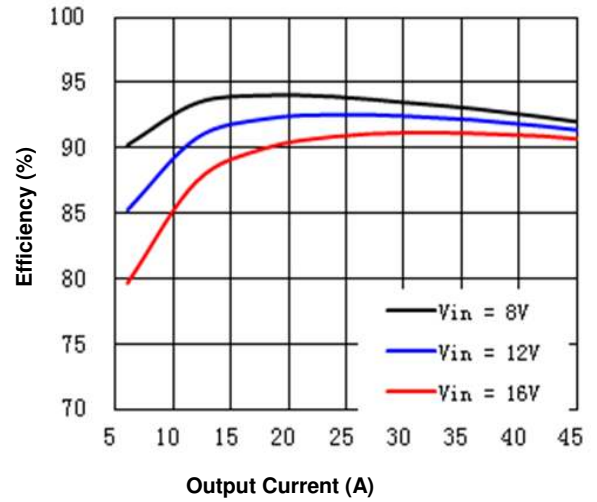

Figure 1(f). Efficiency vs. Load Current (25°C, 2.5V)

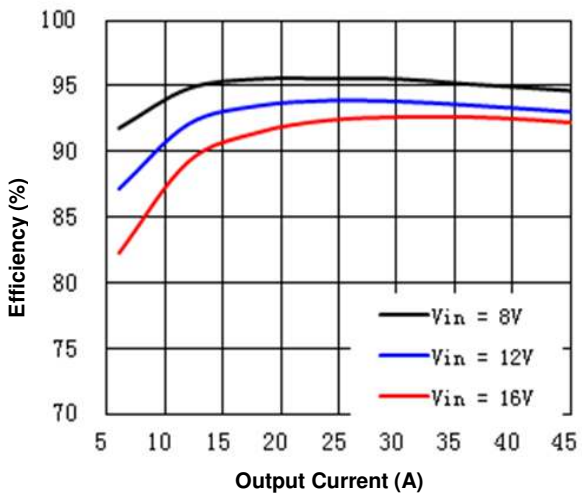

Figure 1(g). Efficiency vs. Load Current (25°C, 3.3V)

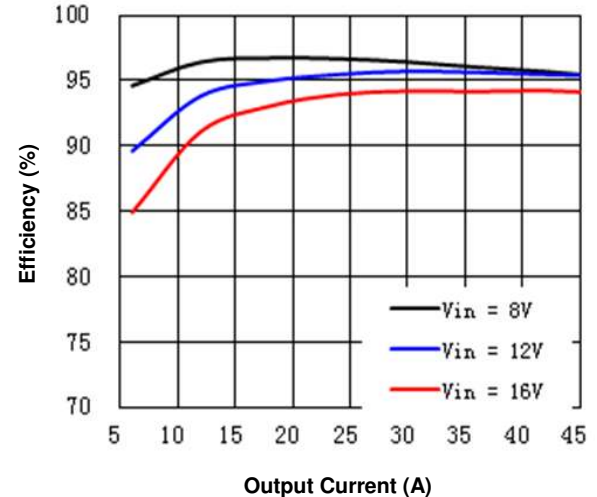

Figure 1(h). Efficiency vs. Load Current (25°C, 5V)

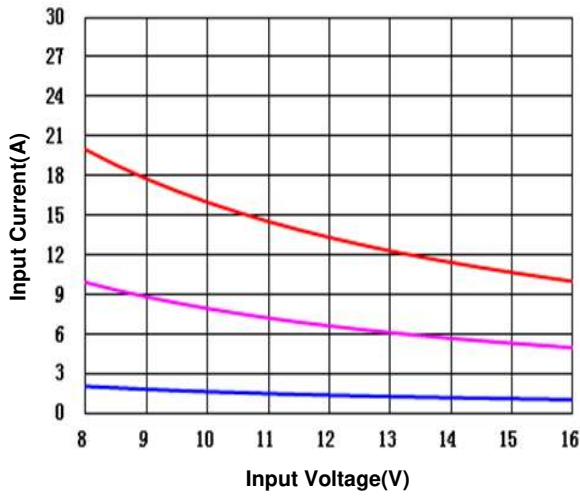

Figure 2. Input Characteristic (3.3V Output)

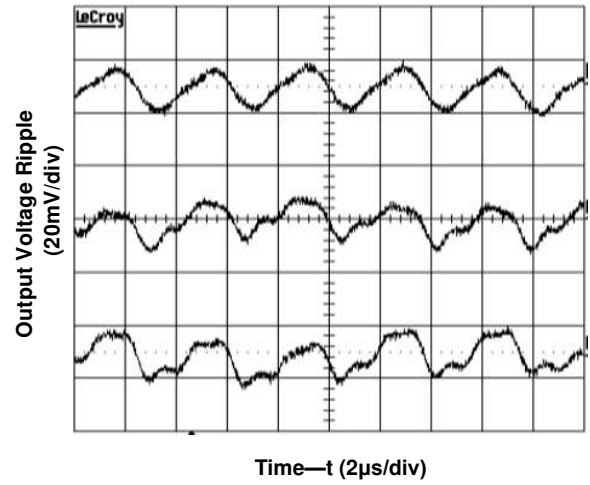

Figure3. Output Ripple Voltage at 2.5V, 45A Output

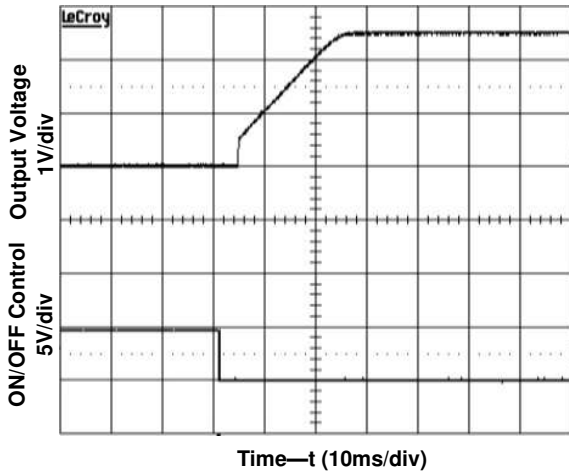

Figure 4. Start-Up from Enable Control  
(Input voltage 12V, Output current 0A)

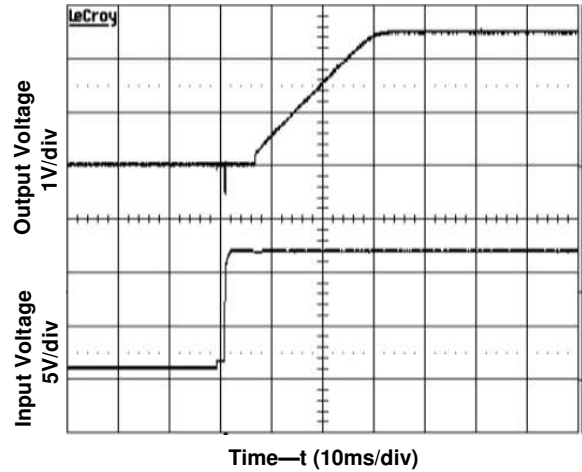

Figure 5. Start-Up from Input Voltage  
(Input voltage 12V, Output current 0A)

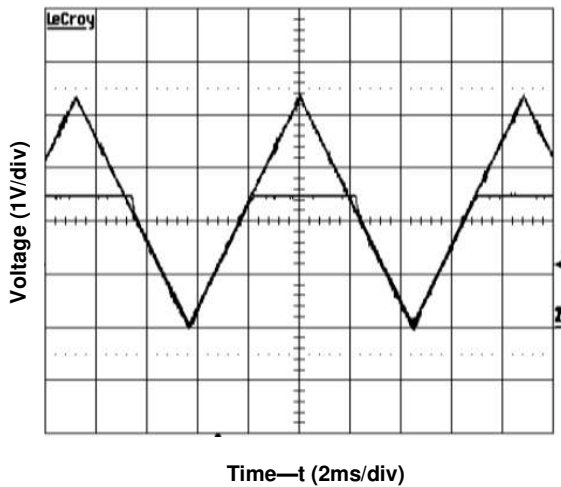

Figure 6. Voltage Tracking/ Sequencing  
(with tracking option)  
 $V_{in}=12V$ ,  $V_o=25V$ ,  $I_o=0A$

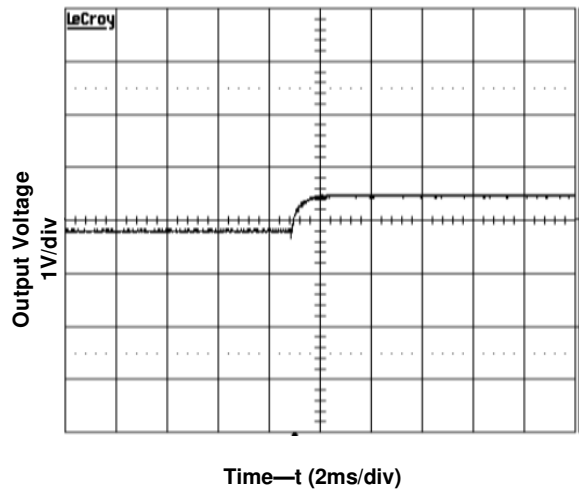
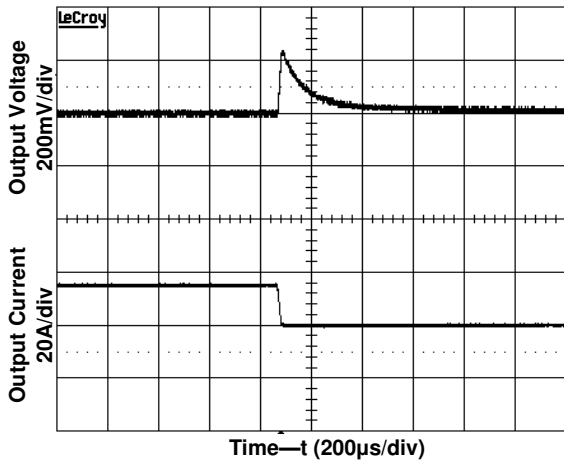
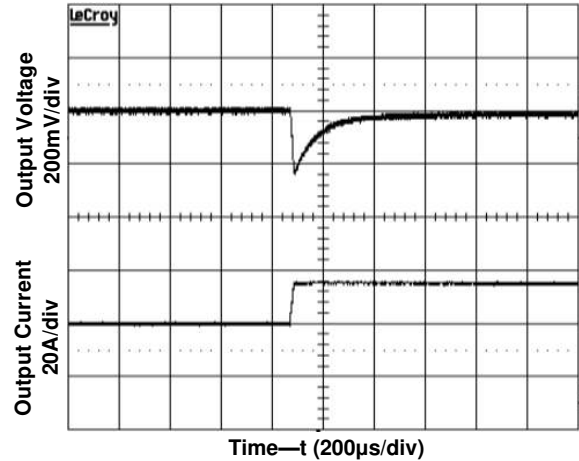

Figure 7. Current Derating Curve for 2.5V Output  
( $V_{in} = 12V$  open frame)

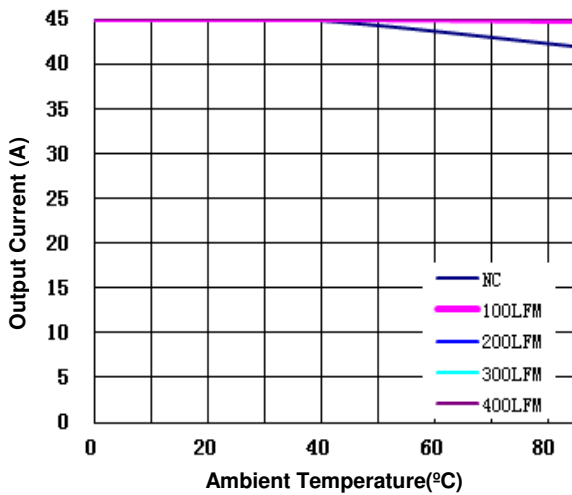

**Figure 8. Transient Load Response**  
Input voltage 12V, Output current 33.7A->22.5A, Slew rate 1A/µs

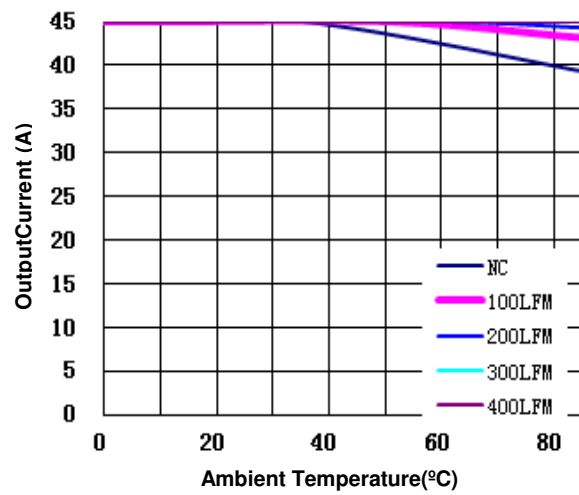

**Figure 9. Transient Load Response**  
Input voltage 12V, Output current 22.5A->33.7A, Slew rate 1A/µs

### Derating curves (Open frame, Vin=12V)



**Figure 10(a). Current Derating Curve for 0.8V Output**



**Figure 10(b). Current Derating Curve for 1.0V Output**

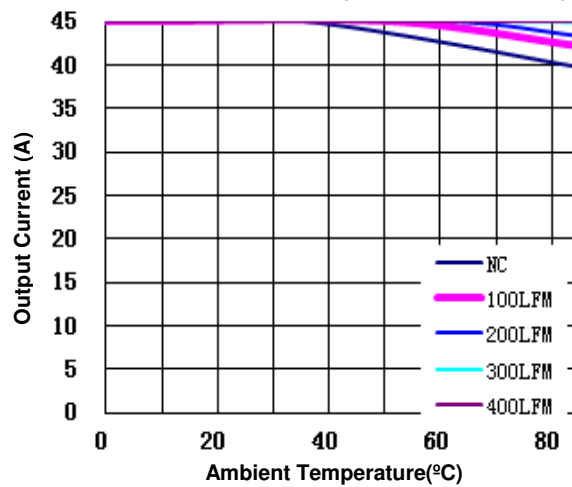

**Figure 10(c). Current Derating Curve for 1.2V Output**

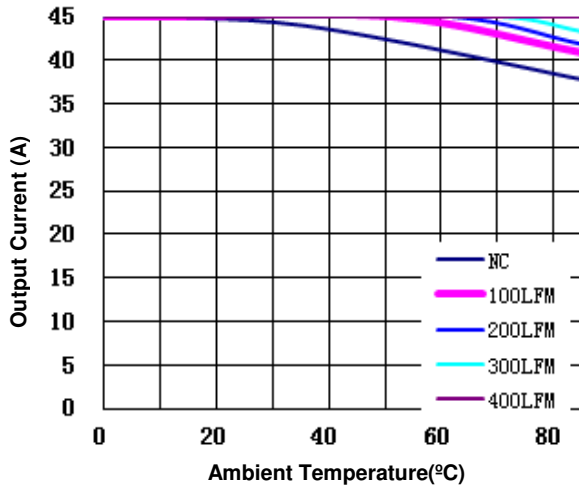

**Figure 10(d). Current Derating Curve for 1.5V Output**

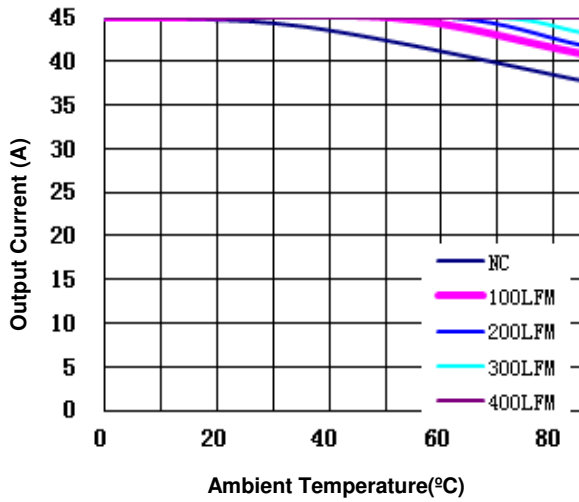

Figure 10(e). Current Derating Curve for 1.8V Output

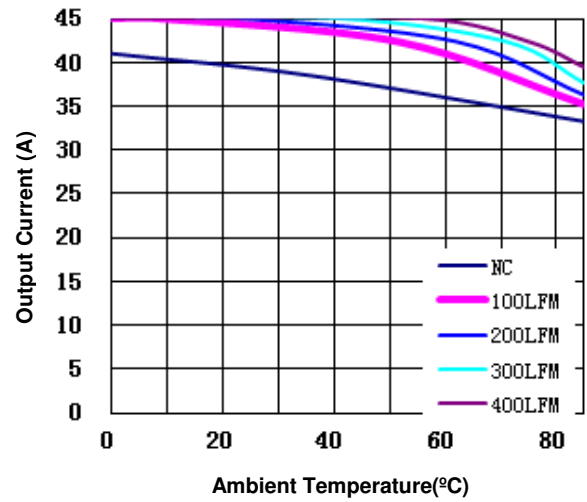

Figure 10(f). Current Derating Curve for 2.5V Output

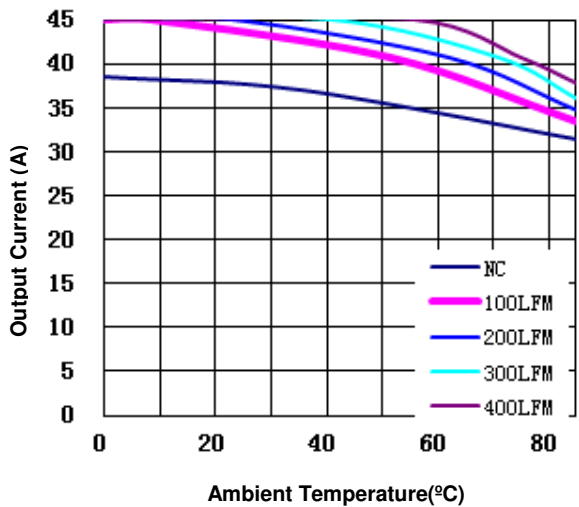

Figure 10(g). Current Derating Curve for 3.3V Output

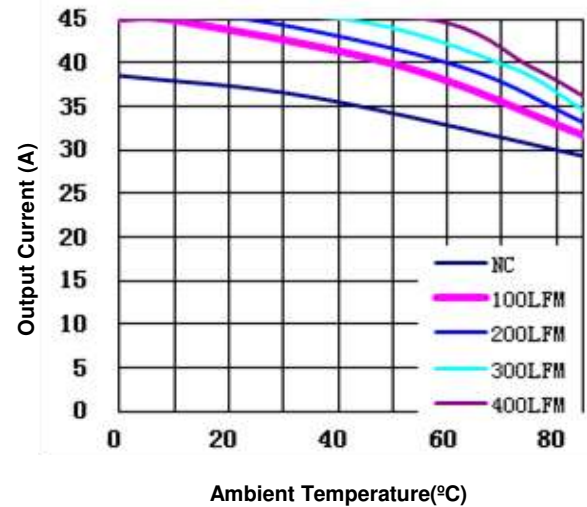

Figure 10(h). Current Derating Curve for 5V Output





## Feature Descriptions

### Remote ON/OFF

The converter can be turned on and off by changing the voltage between the ON/OFF pin and  $V_{in}(-)$ . The NCT Series of converters are available with factory selectable positive logic and negative logic.

For the negative control logic, the converter is ON when the ON/OFF pin is at a logic low level and OFF when the ON/OFF pin is at a logic high level. For the positive control logic, the converter is ON when the ON/OFF pin is at a logic high level and OFF when the ON/OFF pin is at a logic low level. There is no internal pull-up resistor inside the converter. The converter is ON no matter what control logic is when ON/OFF pin is left open (unconnected).

Figure 11 is the recommended ON/Off control circuit for positive logic modules, while Figure 12 is for negative logic modules, both using open collector/drain circuit. Recommended value of the pull up resistor  $R_{pull-up}$  is 50K. The maximum allowable leakage current from this pin at logic-high level is  $20\mu A$ .

The logic low level is from 0V to 0.5V and the maximum sink current during logic low is 2mA. The external switch must be capable of maintaining a logic-low level while sinking up to this current.

Figure 13 shows direct logic control. When this method is used, it's important to make sure that the voltage at the ON/OFF pin is properly set for HIGH and LOW by the direct logic control circuit. For a positive logic enabling NCT module, logic HIGH requires 5.5V or higher voltage at the ON/OFF pin, and logic LOW requires 2.5V or lower voltage at the ON/OFF pin; For a negative logic enabling NCT module, logic HIGH requires 3.5V or higher voltage at the ON/OFF pin, and logic LOW requires 0.5V or lower voltage at the ON/OFF pin.

### Remote SENSE

The remote SENSE pins are used to sense the voltage at the load point to accurately regulate the load voltage and eliminate the impact of the voltage drop in the power distribution path.

The SENSE pin should be connected to the point where regulation is desired. The voltage difference between the output pins must not exceed the

operating range of this converter shown in the specification table.

When remote sense is not used, the SENSE pins should be connected to their corresponding output pins. If the SENSE pins are left floating, the converter will deliver an output voltage slightly higher than its specified typical output voltage.

The converter has an optional feature of Sense- (designated by "3" in Electric Option 2 in the part number). If this option is selected, Pin 7 is the negative remote sense pin, and should be connected to the location where the ground voltage should be sensed. Without this feature, the voltage drop on the ground (common) connection is not compensated by the converter, and it is important to make sure that the connection resistance and voltage drop between GND pin and the load is small.

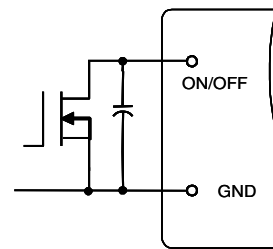

Figure 11. Opto Coupler Enable Circuit

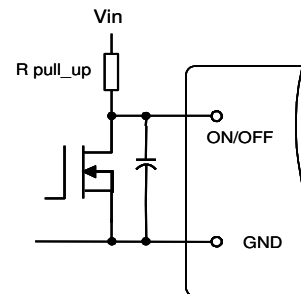

Figure 12. Open Collector Enable Circuit

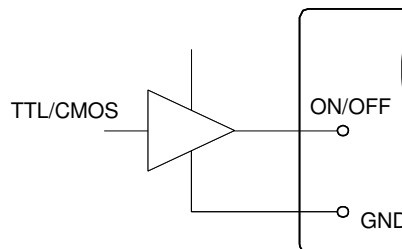

Figure 13. Direct Logic Drive





## Output Voltage Programming and Adjustment

This series of converters are available with variable output voltages. The output voltage is preset to 0.7525V, and can be programmed up to 5.5V using an external trim resistor connected between the Trim pin and GND pin as shown in Figure 14.

The resistance of the external resistor for trimming up the output voltage can be calculated using the equation below:

$$R_{trim} = \left( \frac{10.5}{\Delta} - 1 \right) (k\Omega)$$

Where

$$\Delta = V_o - V_{onom} \text{ and } V_{onom} = 0.7525$$

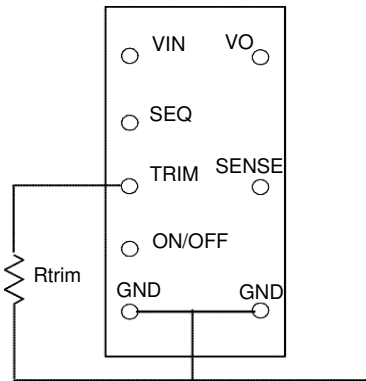

Figure 14. Circuit to Trim Output Voltage.

Because NCT converters use GND as the reference for control, Rtrim should be placed as close to GND pin as possible, and the trace connecting GND pin and Rtrim should not carry significant current, to reduce the effect of voltage drop on the GND trace/plain on the output voltage accuracy. If negative remote sense “Sense –” option is selected in Electric Option 2, the Sense- pin, instead of GND pins, should be connected to Rtrim.

When remote sense and trim functions are used simultaneously, please do not allow the output voltage at the converter output terminals to go outside the operating range.

## Input Under-Voltage Lockout

This feature prevents the converter from starting until the input voltage reaches the turn-on voltage threshold, and keeps the converter running until the

input voltage falls below the turn-off voltage threshold. Both turn-on and turn-off voltage thresholds are defined in the Input Specifications table. The hysteresis prevents oscillations.

## Output Over-Current Protection (OCP)

As a standard feature, the converter turns off when the load current exceeds the current limit. If the over current or short circuit condition persists, the converter will operate in a hiccup mode (repeatedly trying to restart) until the over-current condition is cleared.

## Thermal Shutdown

As a standard feature, the converter will shut down if an over-temperature condition is detected. The converter has a temperature sensor, which detects the thermal condition of key components of the converter.

The thermal shutdown circuit is designed to turn the converter off when the temperature at the sensor reaches 120°C. The converter will resume operation after the converter cools down.

## Voltage Tracking/Sequencing

An optional voltage tracking/sequencing feature is available with these converters. This feature is compatible with the “Voltage Sequencing” feature (DOSA) or the “Voltage Tracking” feature (POLA). If this feature is not used, the corresponding SEQ pin should be left open, or tied to a voltage higher than the output voltage but not higher than Vin.

This feature forces the output of the converter to follow (track) the voltage at the SEQ pin on a 1:1 basis. When the voltage at the SEQ pin rises above the set point, the output of the converter will stay at the set point. This feature allows the user to program the output voltage waveform during turn-on and turn-off of the converter by applying a voltage signal of desired shape at the SEQ pin. When using this function, one should pay careful attention to the following aspects:

- 1). This feature is intended mainly for startup and shutdown sequencing control. In normal operation, the voltage at SEQ pin should be maintained higher than the output voltage set point;



2). The input voltage should be valid for this feature to work. During startup, it is recommended to have a delay of at least 10ms between the establishment of a valid input voltage and the application of a voltage at the SEQ pin;  
3). The ON/OFF pin should be in “Enabled” state when this function is effective.

4). The converter’s pre-bias startup is affected by this function. The converter will still be able to start under a pre-bias condition, but the output voltage waveform will have a glitch during startup if this feature is selected.

## Power Good

When POWER GOOD in Electrical Option 2 is selected (referring to the “Part numbering System” table), the option pin (pin 7) will serve as POWER GOOD signal pin to indicate the output status of the module. There is an open collector transistor with 10k pull up resistor connected to this POWER GOOD pin. The voltage for the pull up resistor is 5V internal bias. Before the output voltage of the NCT module reaches its regulation point, the open collector transistor will hold pin 7 to the ground. After the output voltage reaches the regulation point for 5ms, the open collector transistor will become high impedance and pin 7 will be pull to high.

## Design Considerations

The stability of the NCT1 converters, as with any DC/DC converter, may be compromised if the source impedance is too high or too inductive. It’s desirable to keep the input source AC impedance as low as possible. To reduce switching frequency ripple current getting into the input circuit, it is desirable to place some low ESR capacitors at the input. Due to the existence of some inductance (such as the trace inductance, connector inductance, etc) in the input circuit, possible oscillation may occur at the input of the converter. Because the relatively high input current, it may not be practical or economical to have separate damping or soft start circuit in front of POL converters. We recommend using a combination of ceramic capacitors and Tantalum/Polymer capacitors at the input, so the relatively higher ESR of Tantalum/Polymer capacitors can help to damp the possible oscillation.

Similarly, although the converter is designed to be stable without external capacitor at the output, some low ESR capacitors at the output are desirable to further reduce the output voltage ripple and improve the transient response. A combination of ceramic capacitors and Tantalum/Polymer capacitors at the output usually yields good results.

## Safety Considerations

The NCT1 Series of converters is designed in accordance with EN 60950 Safety of Information Technology Equipment Including Electrical Equipment. The converters are recognized by UL in both USA and Canada to meet the requirements in UL 60950, Safety of Information Technology Equipment and applicable Canadian Safety Requirement, and ULc 60950. Flammability ratings of the PWB and plastic components in the converter meet 94V-0.

The converter’s output meets SELV requirements if all of its input meets SELV requirements.

## Thermal Considerations

The NCT1 converters can operate in various thermal environments. Due to high efficiency and optimal heat distribution, these converters exhibit excellent thermal performance.

The maximum allowable output power of any power converter is usually determined by the electrical design and the maximum operating temperature of its components. The NCT1 converters have been tested comprehensively under various conditions to generate the derating curves with consideration for long term reliability.

Thermal derating curves are highly influenced by derating guideline, the test conditions and setup, such as test temperatures, the interface method between the converter and the test fixture board, spacing and construction (especially copper weight, holes and openings) of the fixture board and the spacing board, temperature measurement method, and the ambient temperature measurement point. The thermal derating curves in this datasheet are obtained by thermal tests in a wind-tunnel. The converter’s power pins are soldered to a 2-layer test fixture board through 18 AWG wires. The space between the test

board and a PWB spacing board is 1". Usually, the end system board has more layer count, and has better thermal conductivity than our test fixture board.

Note that the natural convection condition was measured at 0.05 m/s to 0.15 m/s (10ft./min. to 30 ft./min).

## Heat Transfer

Convection heat transfer is the primary cooling means for NCT1 converters. Therefore, airflow speed is important and increasing the airflow over the converter enhances the heat transfer via convection.

The current derating curves for a few output voltages are presented in this datasheet. To maintain long-term reliability, the module should be operated within these curves in steady state.

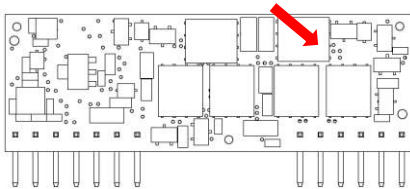

**Figure 15.**Temperature Monitoring Locations

Proper cooling in the end system can be verified by monitoring the temperature of the key components. Figure 15 shows the recommended temperature monitoring points. The temperature at these locations should not exceed 120 °C continuously.

## Heat Transfer with a Heat Plate

The NCT1 Series of converters have the options of using a baseplate for enhanced thermal performance.

For reliable operation, the heat plate temperature should not continuously exceed 100 °C.



## Mechanical Diagrams

### Horizontal Mount

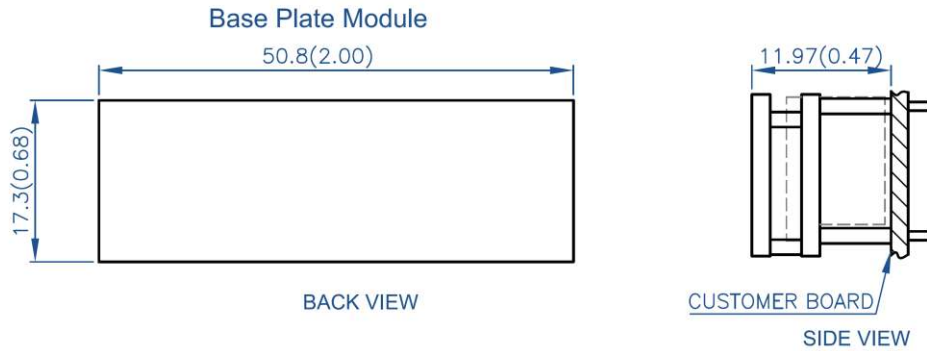
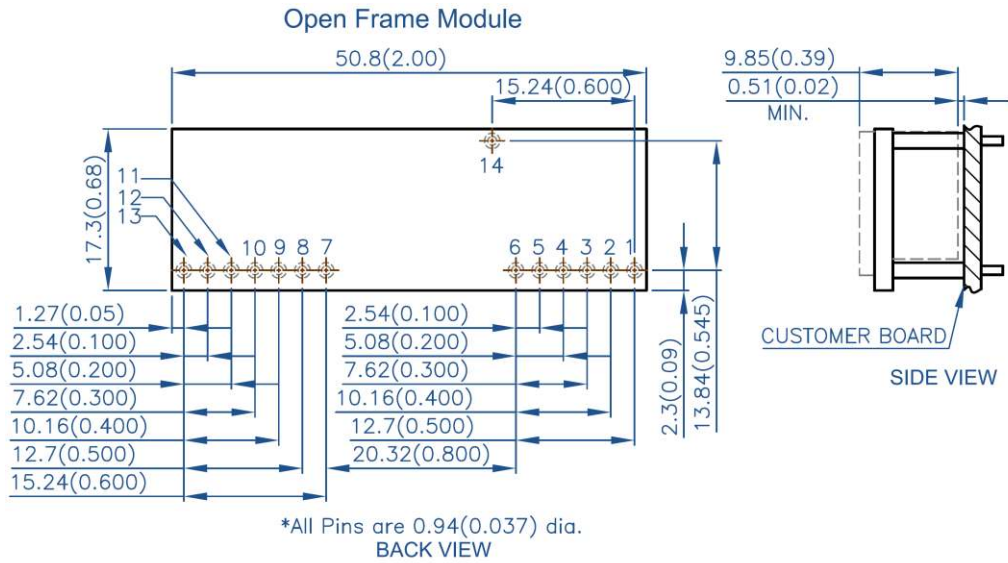

Pin	Name	Function
1	Vout	Output voltage
2	Vout	Output voltage
3	SENSE(+)	Positive remote sense
4	Vout	Output voltage
5	GND	Connected to Vin(-)
6	GND	Connected to Vin(-)
7	OPTION	Freq synch/Power good/Sense-
8	GND	Connected to Vin(-)
9	Vin	Input voltage
10	Vin	Input voltage
11	SEQ	Tracking/Sequencing
12	TRIM	Output voltage adjust
13	ON/OFF	Remote control
14	N/C	Not Connect



## Vertical Mount (SIP)

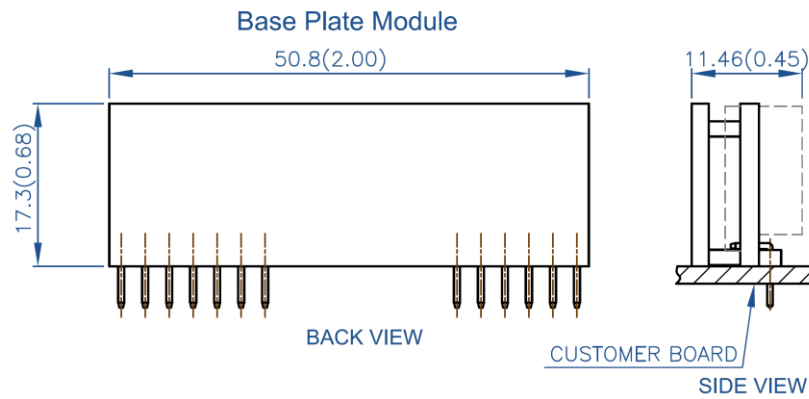
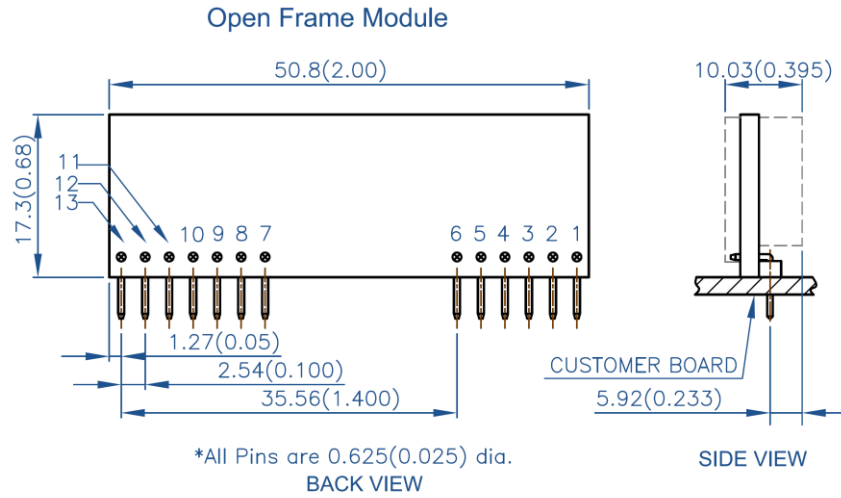

Pin	Name	Function
1	Vout	Output voltage
2	Vout	Output voltage
3	SENSE(+)	Positive remote sense
4	Vout	Output voltage
5	GND	Connected to Vin(-)
6	GND	Connected to Vin(-)
7	OPTION	Freq synch/Power good/Sense-
8	GND	Connected to Vin(-)
9	Vin	Input voltage
10	Vin	Input voltage
11	SEQ	Tracking/Sequencing
12	TRIM	Output voltage adjust
13	ON/OFF	Remote control

### Notes:

- All dimensions in mm (inches)  
Tolerances: .x ± .5 (.xx ± 0.02)  
.xx ± .25 (.xxx ± 0.010)
- A converter's thickness is increased to 0.45" with a baseplate option.
- All pins are coated with 90%/10% solder, Gold, or Matte Tin finish with Nickel under plating.
- Weight: 11.5 g open frame SIP converter
- Workmanship: Meet or exceeds IPC-A-610 Class II
- Baseplate flatness tolerance is 0.10mm (0.004") TIR for surface.