

# ZB4BK1313

Harmony XB4, Illuminated selector switch head, metal, white, Ø22, integral LED, 3 positions, stay put



## Main

|                               |                                      |
|-------------------------------|--------------------------------------|
| Range of Product              | Harmony XB4                          |
| Product or Component Type     | Head for illuminated selector switch |
| Product Compatibility         | Integral LED                         |
| Device short name             | ZB4                                  |
| Bezel material                | Chromium plated metal                |
| Head type                     | Standard                             |
| Mounting diameter             | 0.87 in (22 mm)                      |
| Sale per indivisible quantity | 1                                    |
| Shape of signaling unit head  | Round                                |
| Type of operator              | Stay put                             |
| Operator profile              | White standard handle                |
| Operator position information | 3 positions +/- 45°                  |

## Complementary

|                                    |  |
|------------------------------------|--|
| CAD overall width                  | 1.14 in (29 mm)  |
| CAD overall height                 | 1.14 in (29 mm)  |
| CAD overall depth                  | 1.69 in (43 mm)  |
| Net Weight                         | 0.08 lb(US) (0.036 kg)   |
| Resistance to high pressure washer | 1015.26 psi (7000000 Pa) 131 °F (55 °C) 0.1 m  |
| Mechanical durability              | 1000000 cycles   |
| Electrical composition code        | M3 4 single front mounting integral LED<br>M6 2 single front mounting integral LED and transformer<br>M10 2 single front mounting integral LED<br>M4 4 single and double front mounting integral LED |
| Device presentation                | Basic element  |

## Environment

|                                       |   |
|---------------------------------------|---|
| Protective treatment                  | TH  |
| Ambient Air Temperature for Storage   | -40...158 °F (-40...70 °C)  |
| Ambient air temperature for operation | -40...158 °F (-40...70 °C)  |
| Overvoltage category                  | Class I IEC 60536   |
| IP degree of protection               | IP66 IEC 60529<br>IP67<br>IP69<br>IP69K   |
| NEMA degree of protection             | NEMA 13<br>NEMA 4X  |
| IK degree of protection               | IK06 IEC 50102  |
| Standards                             | CSA C22.2 No 14<br>JIS C8201-5-1<br>EN/IEC 60947-1<br>EN/IEC 60947-5-1<br>EN/IEC 60947-5-5<br>EN/IEC 60947-5-4<br>UL 508<br>JIS C8201-1 |

|                        |  |
|------------------------|--|
| Product Certifications | CSA<br>UL Listed<br>BV<br>GL<br>DNV<br>LROS (Lloyds register of shipping)  |
| Vibration resistance   | 5 gn 2...500 Hz)IEC 60068-2-6  |
| Shock resistance       | 30 gn 18 ms) half sine wave acceleration IEC 60068-2-27<br>50 gn 11 ms) half sine wave acceleration IEC 60068-2-27 |

### Ordering and shipping details

|                       |                                     |
|-----------------------|-------------------------------------|
| Category              | 22468 - PUSHBUTTONS,22MM(METAL) NEW |
| Discount Schedule     | CS2                                 |
| GTIN                  | 3389110890709                       |
| Nbr. of units in pkg. | 1                                   |
| Package weight(Lbs)   | 1.45 oz (41 g)                      |
| Returnability         | Yes                                 |
| Country of origin     | FR                                  |

### Packing Units

|                              |                      |
|------------------------------|----------------------|
| Unit Type of Package 1       | PCE                  |
| Package 1 Height             | 1.30 in (3.3 cm)     |
| Package 1 width              | 1.97 in (5 cm)       |
| Package 1 Length             | 2.05 in (5.2 cm)     |
| Unit Type of Package 2       | BB1                  |
| Number of Units in Package 2 | 5                    |
| Package 2 Weight             | 7.23 oz (205 g)      |
| Package 2 Height             | 1.97 in (5 cm)       |
| Package 2 width              | 1.30 in (3.3 cm)     |
| Package 2 Length             | 10.39 in (26.4 cm)   |
| Unit Type of Package 3       | S02                  |
| Number of Units in Package 3 | 100                  |
| Package 3 Weight             | 9.70 lb(US) (4.4 kg) |
| Package 3 Height             | 5.91 in (15 cm)      |
| Package 3 width              | 11.81 in (30 cm)     |
| Package 3 Length             | 15.75 in (40 cm)     |

### Offer Sustainability

|                            |   |
|----------------------------|---|
| Sustainable offer status   | Green Premium product   |
| California proposition 65  | WARNING: This product can expose you to chemicals including: Di-isodecyl phthalate (DIDP), which is known to the State of California to cause birth defects or other reproductive harm. For more information go to <a href="http://www.P65Warnings.ca.gov">www.P65Warnings.ca.gov</a> |
| REACH Regulation           | <a href="#">REACH Declaration</a>   |
| REACH free of SVHC         | Yes   |
| EU RoHS Directive          | Pro-active compliance (Product out of EU RoHS legal scope) <a href="#">EU RoHS Declaration</a>  |
| Toxic heavy metal free     | Yes   |
| Mercury free               | Yes   |
| RoHS exemption information | <a href="#">Yes</a>   |
| China RoHS Regulation      | <a href="#">China RoHS Declaration</a>  |
| Environmental Disclosure   | <a href="#">Product Environmental Profile</a>   |
| Circularity Profile        | <a href="#">End Of Life Information</a>   |

### Contractual warranty

|          |           |
|----------|-----------|
| Warranty | 18 months |
|----------|-----------|

Dimensions

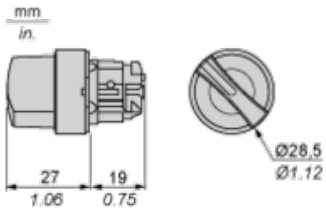

Panel Cut-out for Pushbuttons, Switches and Pilot Lights (Finished Holes, Ready for Installation)

| Connection by Screw Clamp Terminals or Plug-in Connectors or on Printed Circuit Board   | Connection by Faston Connectors   |
|---|---|
|    |  |
| <p>(1) Diameter on finished panel or support<br/>                 (2) 40 mm min. / 1.57 in. min.<br/>                 (3) 30 mm min. / 1.18 in. min.<br/>                 (4) <math>\varnothing 22.5</math> mm / 0.89 in. recommended (<math>\varnothing 22.3</math> mm <math>_0^{+0.4}</math> / 0.88 in. <math>_0^{+0.016}</math>)<br/>                 (5) 45 mm min. / 1.78 in. min.<br/>                 (6) 32 mm min. / 1.26 in. min.</p> |   |

Pushbuttons, Switches and Pilot Lights for Printed Circuit Board Connection

Panel Cut-outs (Viewed from Installer's Side)

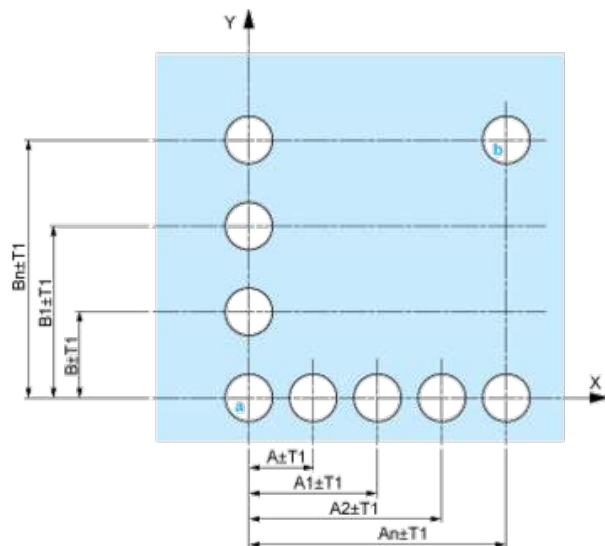

A: 30 mm min. / 1.18 in. min.  
 B: 40 mm min. / 1.57 in. min.

Printed Circuit Board Cut-outs (Viewed from Electrical Block Side)

Dimensions in mm



A: 30 mm min.  
 B: 40 mm min.  
 Dimensions in in.

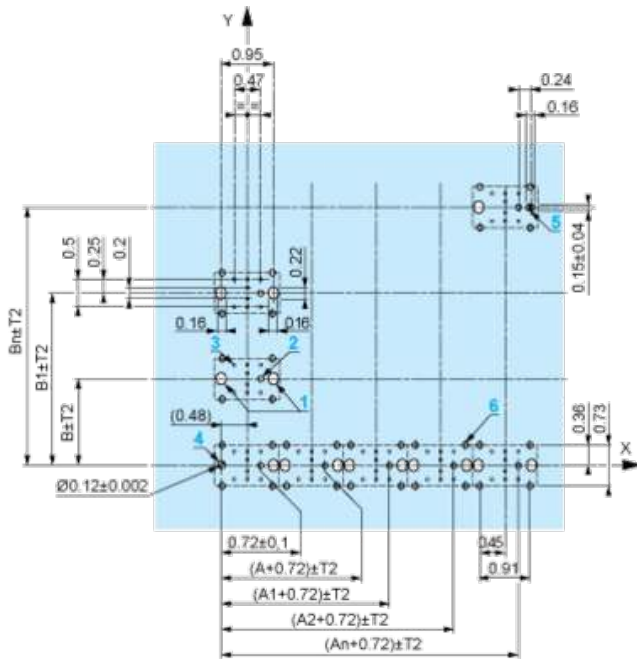

A: 1.18 in. min.  
 B: 1.57 in. min.

### General Tolerances of the Panel and Printed Circuit Board

The cumulative tolerance must not exceed 0.3 mm / 0.012 in:  $T1 + T2 = 0.3 \text{ mm max.}$

### Installation Precautions

- Minimum thickness of circuit board: 1.6 mm / 0.06 in.
- Cut-out diameter: 22.4 mm  $\pm$  0.1 / 0.88 in.  $\pm$  0.004
- Orientation of body/fixing collar ZB4 BZ009:  $\pm 2^\circ 30'$  (excluding cut-outs marked a and b).
- Tightening torque of screws ZBZ 006: 0.6 N.m (5.3 lbf.in) max.
- Allow for one ZB4 BZ079 fixing collar/pillar and its fixing screws:
  - every 90 mm / 3.54 in. horizontally (X), and 120 mm / 4.72 in. vertically (Y).
  - with each selector switch head (ZB4 BD•, ZB4 BJ•, ZB4 BG•).

The fixing centers marked a and b are diagonally opposed and must align with those marked 4 and 5.



(1) Panel

(2) Printed circuit board

### Mounting of Adapter (Socket) ZBZ 01•

- 1 2 elongated holes for ZBZ 006 screw access
- 2 1 hole  $\varnothing 2.4 \text{ mm} \pm 0.05 / 0.09 \text{ in.} \pm 0.002$  for centring adapter ZBZ 01•
- 3 8 ×  $\varnothing 1.2 \text{ mm} / 0.05 \text{ in.}$  holes
- 4 1 hole  $\varnothing 2.9 \text{ mm} \pm 0.05 / 0.11 \text{ in.} \pm 0.002$ , for aligning the printed circuit board (with cut-out marked a)
- 5 1 elongated hole for aligning the printed circuit board (with cut-out marked b)
- 6 4 holes  $\varnothing 2.4 \text{ mm} / 0.09 \text{ in.}$  for clipping in adapter ZBZ 01•

Dimensions An + 18.1 relate to the  $\varnothing 2.4 \text{ mm} \pm 0.05 / 0.09 \text{ in.} \pm 0.002$  holes for centring adapter ZBZ 01•.

---

Electrical Composition Corresponding to Code M3

---



---

Electrical Composition Corresponding to Code M4

---



---

Electrical Composition Corresponding to Codes M6 and P2

---



---

Electrical Composition Corresponding to Codes M5, M10, MF1, MR1 and MF2

---



---

Legend

---

Single contact

Double contact

Light block





Possible location



### Sequence of Contacts Fitted to 3-position Selector Switch Body





#### Position 315°



|          |   |   |        |  |   |
|----------|---|---|--------|--|---|
| Push     | Position  | Top   |        |  |  |
| Bottom   |  |  |        |  |   |
| Location |   | Left  | Right  |  |   |
| State    |   | 1   | 0      |  |   |
| Contacts | N/O   |   | closed | open   |   |
| N/C      |   | open  | closed |  |   |

#### Position 0°







|          |   |   |   |   |   |
|----------|---|---|---|---|---|
| Push     | Position  | Top   |  |  |  |
| Bottom   |  |  |   |   |   |
| Location |   | Left  | Right   |   |   |
| State    |   | 0   | 0   |   |   |
| Contacts | N/O   |   | open  | open  |   |
| N/C      |   | closed  | closed  |   |   |



Position 45°



|          |   |   |   |   |  |
|----------|---|---|---|---|--|
| Push     | Position  | Top   |  |  |  |
| Bottom   |  |  |   |   |  |
| Location |   | Left  | Right   |   |  |
| State    |   | 0   | 1   |   |  |
| Contacts | N/O   |   | open  | closed  |  |
| N/C      |   | closed  | open  |   |  |