

Printed-circuit board connector - FKCS 2,5/ 5-ST-5,08-RF - 1808598

Please be informed that the data shown in this PDF Document is generated from our Online Catalog. Please find the complete data in the user's documentation. Our General Terms of Use for Downloads are valid (<http://download.phoenixcontact.com>)

Plug component, Nominal current: 12 A, Rated voltage (III/2): 320 V, Number of positions: 5, Pitch: 5.08 mm, Connection method: Spring-cage conn., Color: green, Contact surface: Tin



Key commercial data

Packing unit	0
Minimum order quantity	1
GTIN	 4 046356 701389
Custom tariff number	85366990
Country of origin	GERMANY

Technical data

Dimensions / positions

Length	25.2 mm
Height	15 mm
Pitch	5.08 mm
Dimension a	20.32 mm
Number of positions	5

Technical data

Range of articles	FKCS 2,5/...-ST-RF
Insulating material group	I
Rated surge voltage (III/3)	4 kV
Rated surge voltage (III/2)	4 kV
Rated surge voltage (II/2)	4 kV
Rated voltage (III/2)	320 V
Rated voltage (II/2)	630 V
Connection in acc. with standard	EN-VDE
Nominal current I _N	12 A
Nominal voltage U _N	250 V

Printed-circuit board connector - FKCS 2,5/ 5-ST-5,08-RF - 1808598

Technical data

Technical data

Nominal cross section	2.5 mm ²
Maximum load current	12 A
Insulating material	PA
Inflammability class according to UL 94	V0
Internal cylindrical gage	A2
Stripping length	10 mm
Nominal voltage, UL/CUL Use Group B	300 V
Nominal current, UL/CUL Use Group B	10 A
Nominal voltage, UL/CUL Use Group D	300 V
Nominal current, UL/CUL Use Group D	10 A

Connection data

Conductor cross section solid min.	0.2 mm ²
Conductor cross section solid max.	2.5 mm ²
Conductor cross section stranded min.	0.2 mm ²
Conductor cross section stranded max.	2.5 mm ²
Conductor cross section stranded, with ferrule without plastic sleeve min.	0.25 mm ²
Conductor cross section stranded, with ferrule without plastic sleeve max.	2.5 mm ²
Conductor cross section stranded, with ferrule with plastic sleeve min.	0.25 mm ²
Conductor cross section stranded, with ferrule with plastic sleeve max.	2.5 mm ²
Conductor cross section AWG/kcmil min.	24
Conductor cross section AWG/kcmil max	12
2 conductors with same cross section, stranded, TWIN ferrules with plastic sleeve, min.	0.5 mm ²
2 conductors with same cross section, stranded, TWIN ferrules with plastic sleeve, max.	1 mm ²
Minimum AWG according to UL/CUL	26
Maximum AWG according to UL/CUL	12

Classifications

ETIM

ETIM 4.0	EC002638
ETIM 5.0	EC002638

UNSPSC

UNSPSC 11	39121409
UNSPSC 12.01	39121409
UNSPSC 13.2	39121409
UNSPSC 6.01	30211810

Printed-circuit board connector - FKCS 2,5/ 5-ST-5,08-RF - 1808598

Classifications

UNSPSC

UNSPSC 7.0901	39121409
---------------	----------

eCl@ss

eCl@ss 4.0	272607xx
eCl@ss 4.1	27260701
eCl@ss 5.0	27260701
eCl@ss 5.1	27141190
eCl@ss 6.0	27260704
eCl@ss 7.0	27440402

Approvals

Approvals

Approvals

UL Recognized / cUL Recognized / cULus Recognized

Ex Approvals

Approvals submitted

Approval details

UL Recognized 		
	B	D
mm ² /AWG/kcmil	26-12	26-12
Nominal current I _N	10 A	10 A
Nominal voltage U _N	300 V	300 V

cUL Recognized 		
	B	D
mm ² /AWG/kcmil	26-12	26-12
Nominal current I _N	10 A	10 A
Nominal voltage U _N	300 V	300 V

Printed-circuit board connector - FKCS 2,5/ 5-ST-5,08-RF - 1808598

Approvals

cULus Recognized 

Accessories

Accessories

Marking

Marker cards - SK 5/3,8:FORTL.ZAHLEN - 0804183



Marker cards, Card, white, labeled, Horizontal: Consecutive numbers 1 - 10, 11 - 20, etc. up to 91 - (99)100, Mounting type: Adhesive, For terminal block width: 5 mm

Plug/Adapter

Coding profile - CP-MSTB - 1734634



Keying profile, is inserted into the slot on the plug or inverted header, red insulating material

Test plugs - MPS-MT - 0201744



Test plugs

Reducing plug - RPS - 0201647



Reducing plug, Color: gray

Tools

Printed-circuit board connector - FKCS 2,5/ 5-ST-5,08-RF - 1808598

Accessories

Screwdriver - SZS 0,6X3,5 - 1205053



Actuation tool, for ST terminal blocks, insulated, also suitable for use as a bladed screwdriver, size: 0.6 x 3.5 x 100 mm, 2-component grip, with non-slip grip

Drawings

Printed-circuit board connector - FKCS 2,5/ 5-ST-5,08- RF - 1808598

Dimensioned drawing

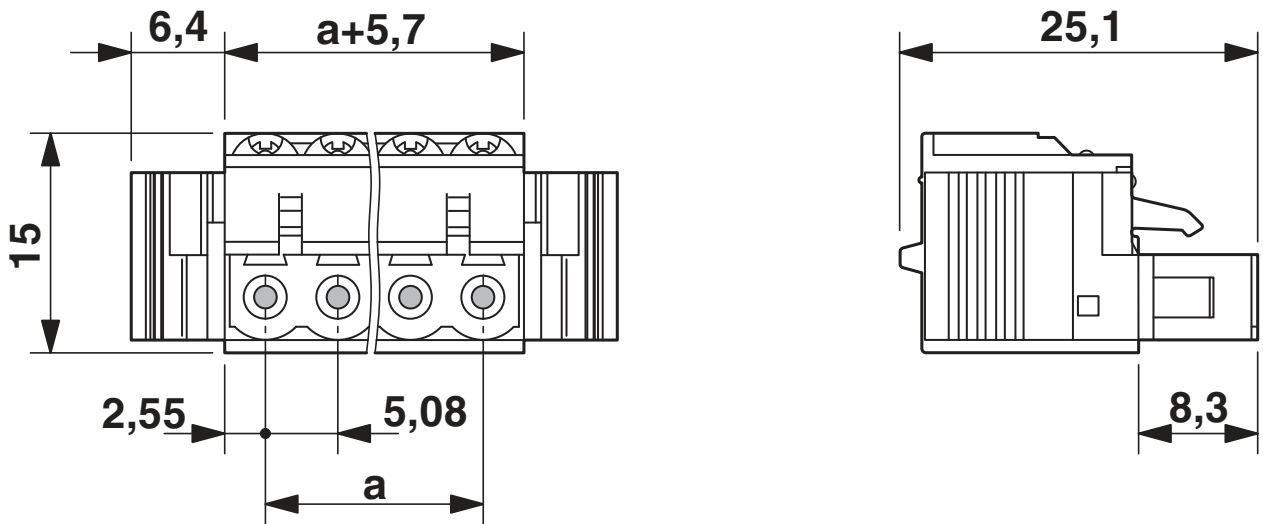



© Phoenix Contact 2012 - all rights reserved
<http://www.phoenixcontact.com>