

bq34z110EVM Wide-Range Impedance Track™ Enabled Fuel Gauge Solution for Lead-Acid Batteries

This evaluation module (EVM) is a complete evaluation system for the bq34z110 wide-range fuel gauge for lead-acid chemistries when combined with an EV2300 USB adapter and Windows®-based PC software, downloadable from the TI.com website.

The circuit module includes one bq34z110 integrated circuit (IC) and all other components necessary to monitor and predict capacity in 2 or more series cell Lead Acid battery packs. The circuit module connects directly across the battery.

With the EV2300 interface adapter and software, it is possible to read the bq34z110 data registers, program the chip for different pack configurations, log cycling data for further evaluation, and evaluate the overall functionality of the bq34z110 solution under different charge and discharge conditions.

Contents

1	Features	2
1.1	Kit Contents	2
1.2	Ordering Information	2
2	bq34z110 Device-Based Circuit Module	3
2.1	Circuit Module Connections	3
2.2	Pin Descriptions	3
3	bq34z110 Circuit Module	3
3.1	Choosing SingleCell (1S) or MultiCell operation	3
3.2	Choosing Maximum MultiCell Battery Voltage	3
3.3	Choosing the LED configuration	4
3.4	Choosing the ALERT configuration	4
4	Circuit Module Physical Layouts, Schematic, and Bill of Materials	4
4.1	Board Layout	4
4.2	Schematic	8
4.3	bq34z110 Circuit Module Performance Specification Summary	11
5	EVM Hardware and Software Setup	11
5.1	System Requirements	11
5.2	Software Installation	11
5.3	Troubleshooting Unexpected Dialog Boxes	11
5.4	Hardware Connection	11
5.5	Operation	13
5.6	Calibration Screen	16
5.7	I ² C Pro (Advanced) Screen	17
5.8	Send HDQ Screen	18
5.9	bqChem	19
5.10	Related Documentation from Texas Instruments	19

List of Figures

1	bq34z110EVM Layout (Silkscreen)	4
2	bq34z110EVM Top Assembly	5
3	bq34z110EVM Top Layer	5

Impedance Track is a trademark of Texas Instruments, Inc.
 Windows is a registered trademark of Microsoft Corporation.

4	bq34z110EVM Inner Layer 1	6
5	bq34z110EVM Inner Layer 2	6
6	bq34z110EVM Bottom Layer	7
7	bq34z110EVM Schematic	8
8	bq34z110 Circuit Module Connection to Cells and System Load and Charger	12
9	Data RAM Screen	14
10	Data Flash Screen, Gas Gauging Class	15
11	Calibration Screen	16
12	I ² C Pro (Advanced) Screen	17
13	Send HDQ Screen	18
14	bqChem Screen	19

List of Tables

1	Ordering Information	2
2	bq34z110EVM Bill of Materials	9
3	Performance Specification Summary	11
4	Circuit Module to EV2300 or EV2400 Connections	12

1 Features

- Complete evaluation system for the bq34z110 advanced gas gauge with Impedance Track™ technology.
- Populated circuit module for quick setup
- Link to software allowing data logging for system analysis

1.1 Kit Contents

- bq34z110 circuit module
- Support documentation

1.2 Ordering Information

Table 1. Ordering Information

EVM Part Number	Chemistry	Configuration	Capacity
bq34z110EVM	Lead Acid	3 V–65 V	Any

2 bq34z110 Device-Based Circuit Module

The bq34z110-based circuit module is a complete and compact example solution of a bq34z110 fuel gauge solution for Lead Acid packs. The circuit module incorporates a bq34z110 fuel gauge IC and various option components and jumpers necessary for evaluation under various battery voltage, LED, and ALERT signal configurations.

2.1 Circuit Module Connections

Contacts on the circuit module provide the following connections:

- Direct connection to BAT+ and BAT–
- The system load and charger connect across BAT+ and PACK–
- To the I²C and HDQ serial communication ports
- To the ALERT output

2.2 Pin Descriptions

PIN NAME	DESCRIPTION
BAT +	Positive battery stack and pack connection
BAT –	Negative battery stack connection
PACK –	Pack negative terminal
SDA	I ² C data signal
SCL	I ² C clock signal
GND	Communication and ALERT grounds
HDQ	HDQ serial communication signal
ALERT	ALERT output signal

3 bq34z110 Circuit Module

This section contains information on the schematic for the bq34z110 implementation.

3.1 Choosing SingleCell (1S) or MultiCell operation

The bq34z110 operates in one of two modes for measuring battery voltage. Place two jumpers on header J5 to select the mode of operation. Refer to the silk screen markings near J5 on the EVM.

WARNING

Applying a voltage higher than 5 V when jumpers are configured for ≤ 5-V operation is very likely to damage the IC.

The ≤ 5-V mode simplifies the circuit from that shown in the schematic. Most of the components shown to the left of the bq34z110 are not necessary.

3.2 Choosing Maximum MultiCell Battery Voltage

In the MultiCell > 5-V setup, three levels of maximum battery voltage: 16, 32, and 48 V are selectable on the header J2. Refer to the schematic and silkscreen markings on the EVM for jumper placement. Ideally, the total divider ratio, including the 16.5-kΩ resistor, R28, converts the maximum expected voltage on the battery to something between 0.8 V and 1.0 V at the BAT pin of the gauge. For this reason, test points TP1 and TP2 are provided to customize the top leg of the divider for your application. While the bq34z110 firmware is able to handle battery voltage up to 65 V, voltages above 50 V should never be applied to the EVM.

3.3 Choosing the LED configuration

When configuring the data flash registers, choose one of five LED/Comm configuration codes (refer to Table 12 in the bq34z110 datasheet). After reviewing those possibilities, select the jumper pattern desired for the J6 header on the EVM. For single-LED mode, place a jumper on the pair marked A. For four-direct LED mode, place jumpers on A, B, C, and D. For external LEDs using the shift register option, place a single jumper on EXT. In all cases, where one or more LED's are used, place a jumper across the J1 header to provide power to the LED.

3.4 Choosing the ALERT configuration

The pin used to provide the ALERT output depends on the LED mode selected in the LED/Comm data flash register. Refer to Table 13 in the bq34z110 datasheet for a guide to the proper ALERT pin, then place one and only one jumper on the J3 header accordingly.

4 Circuit Module Physical Layouts, Schematic, and Bill of Materials

This section contains the board layout, assembly drawings, schematic, and bill of materials for the bq34z110 circuit module.

4.1 Board Layout

Figure 1 through Figure 6 show the PCB layers, and assembly drawing for the bq34z110 module.

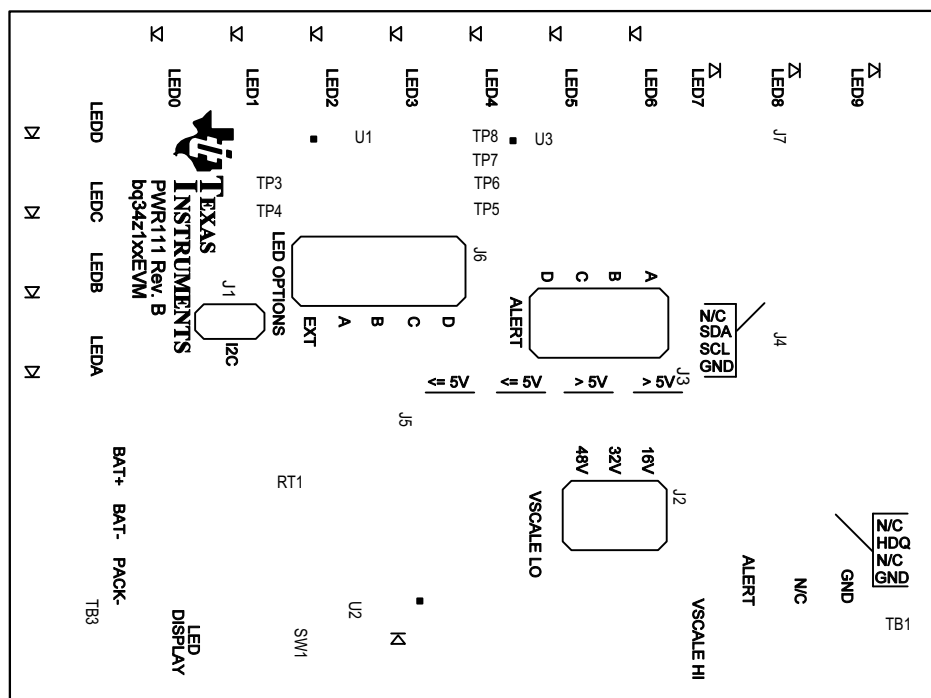

Figure 1. bq34z110EVM Layout (Silkscreen)

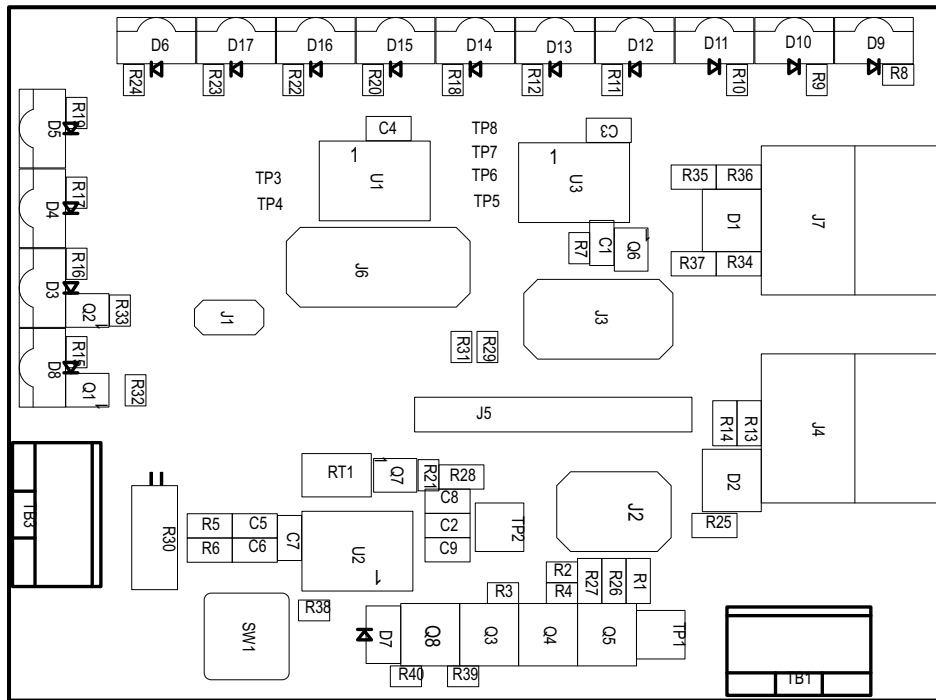

Figure 2. bq34z110EVM Top Assembly

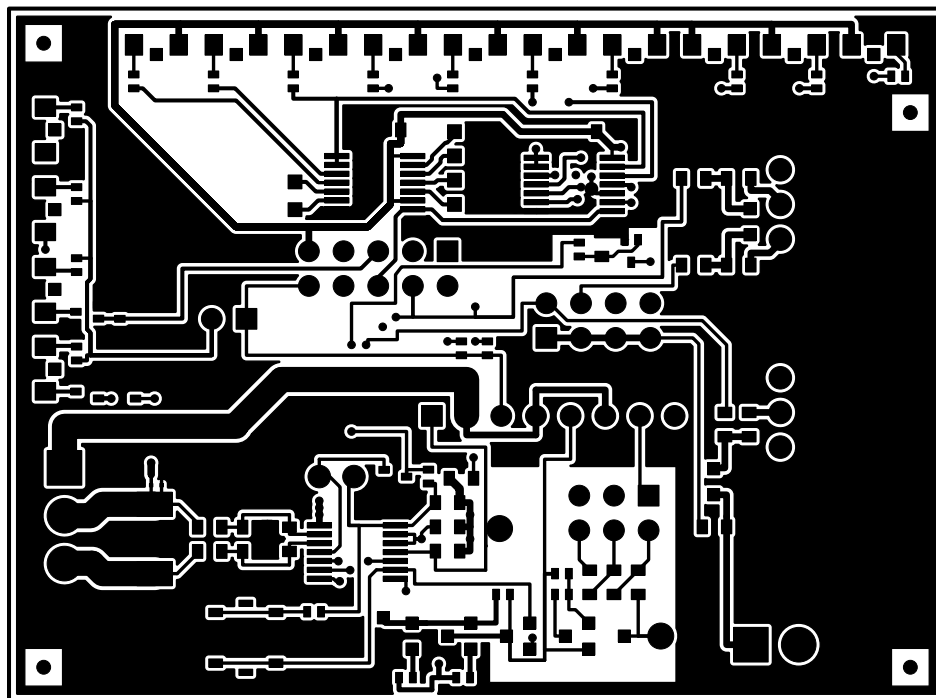

Figure 3. bq34z110EVM Top Layer

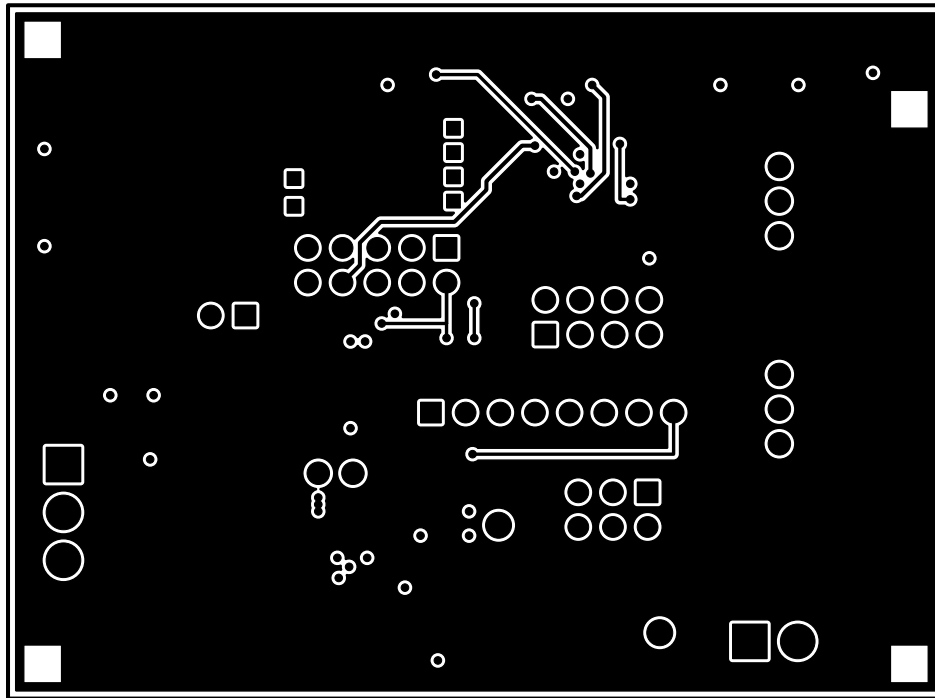

Figure 4. bq34z110EVM Inner Layer 1

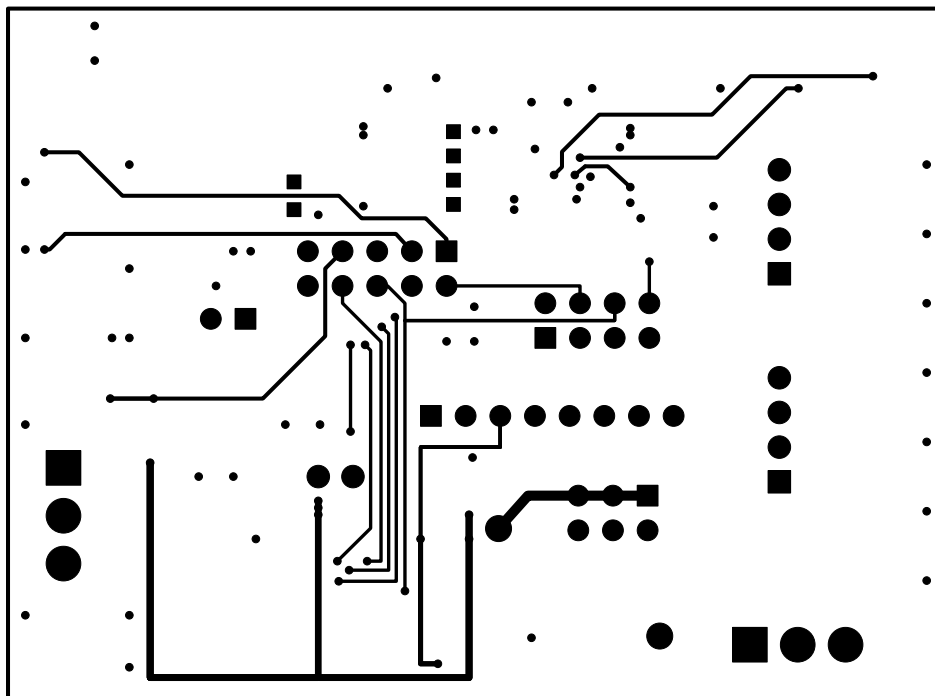

Figure 5. bq34z110EVM Inner Layer 2

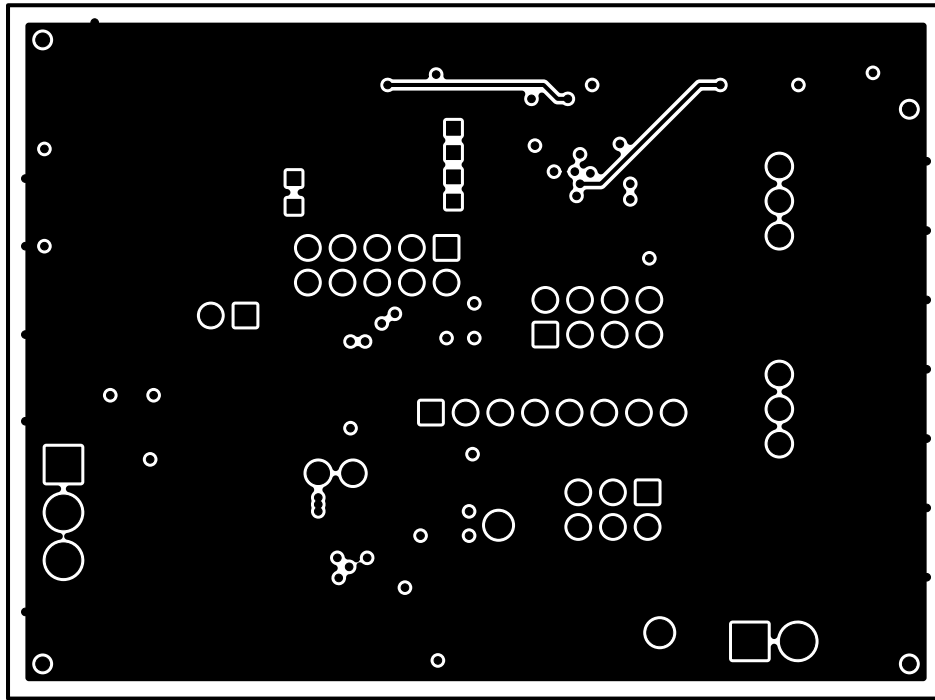

Figure 6. bq34z110EVM Bottom Layer

4.2 Schematic

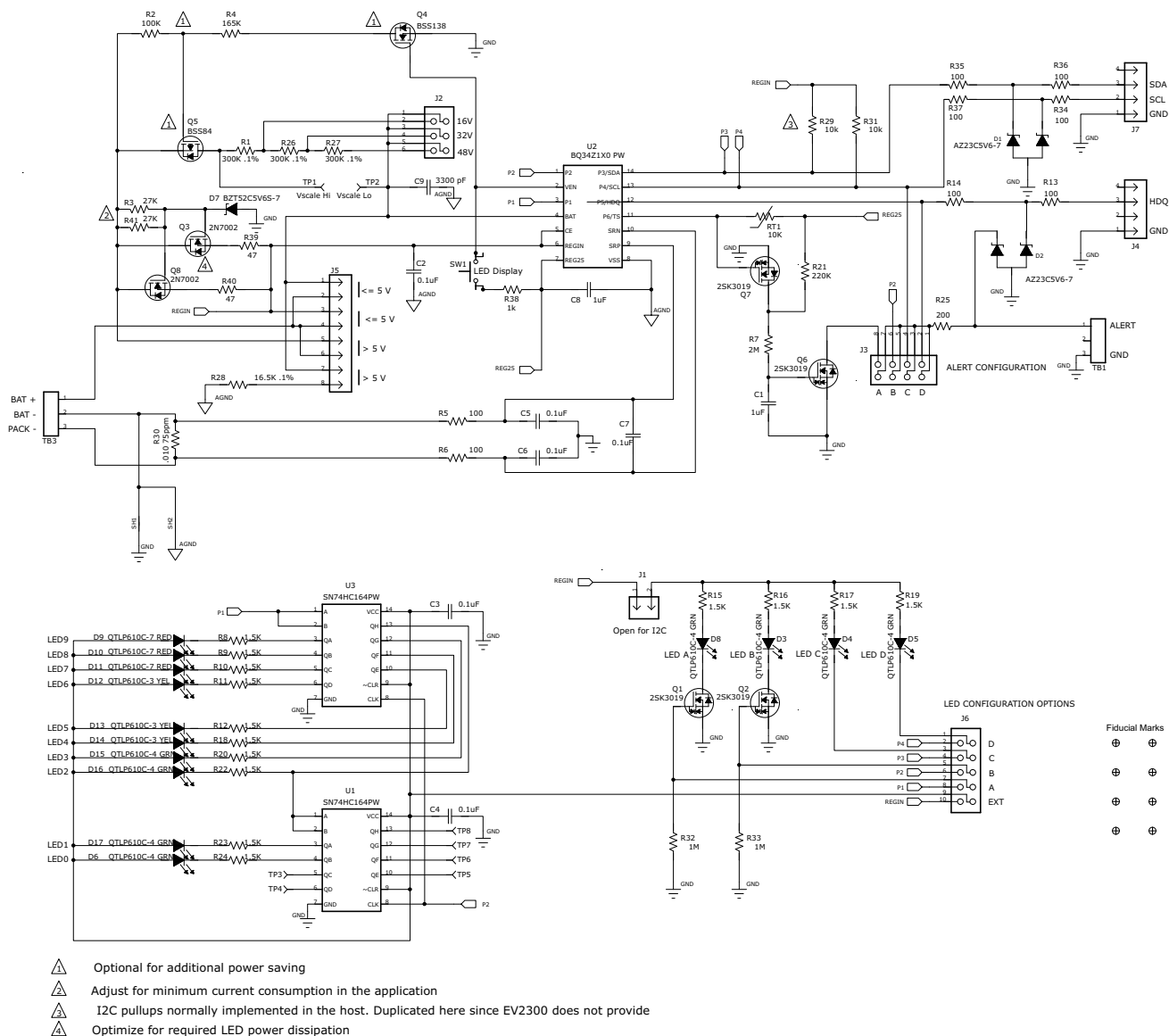

Figure 7. bq34z110EVM Schematic

4.2.1 Bill of Materials

Table 2 is the BOM for the bq34z110EVM.

Table 2. bq34z110EVM Bill of Materials

Count		RefDes	Value	Description	Size	Part Number	MFR
-001	-002						
2	2	C1, C8	1uF	Capacitor, Ceramic, 6.3V, X7R, 20%	0603	Std	Any
6	6	C2-C7	0.1uF	Capacitor, Ceramic, 50V, X7R, 20%	0603	Std	Any
1	1	C9	3300 pF	Capacitor, Ceramic, 50V, X7R, 20%	0603	Std	Any
2	2	D1, D2	AZ23C5V6-7	Diode, Dual, Zener, 5.6 V, 300mW	SOT23	AZ23C5V6-7	Diodes
3	3	D12, D13, D14	QTLP610C-3 YEL	Diode, LED yellow, 30-mA	0.126 x 0.087 inch	QTLP610C-3	Fairchild
8	8	D3-D6, D8, D15-D17	QTLP610C-4 GRN	Diode, LED green, 30-mA	0.126 x 0.087 inch	QTLP610C-4	Fairchild
1	1	D7	BZT52C5V6S-7	Diode, Zener, 200mW, 5.6V	SOD-323	BZT52C5V6S-7	Diodes Inc
3	3	D9, D10, D11	QTLP610C-7 RED	Diode, LED red, 30-mA	0.126 x 0.087 inch	QTLP610C-7	Fairchild
1	1	J1	PEC02SAAN	Header, Male 2-pin, 100mil spacing,	0.100 inch x 2	PEC02SAAN	Sullins
1	1	J2	PEC03DAAN	Header, Male 2x3-pin, 100mil spacing	0.20 inch x 0.30	PEC03DAAN	Sullins
1	1	J3	PEC04DAAN	Header, Male 2x4-pin, 100mil spacing	0.20 x 0.40 inch	PEC04DAAN	Sullins
2	2	J4, J7	22-05-3041	Header, Friction Lock Ass'y, 4-pin Right Angle	0.400 x 0.500	22-05-3041	Molex
1	1	J5	PEC08SAAN	Header, Male 8-pin, 100mil spacing,	0.100 inch x 8	PEC08SAAN	Sullins
1	1	J6	PEC05DAAN	Header, Male 2x5-pin, 100mil spacing	0.100 inch x 5 X 2	PEC05DAAN	Sullins
4	4	Q1, Q2, Q6, Q7	2SK3019	MOSFET, Nch, 30V, 100mA, 8 Ohm	SC-75A	2SK3019	Rohm
2	2	Q3 Q8	2N7002	MOSFET, N-ch, 60-V, 115-mA, 1.2-Ohms	SOT23	2N7000-7-F	Diodes Inc
1	1	Q4	BSS138	MOSFET, Nch, 50V, 0.22A, 3.5 Ohm	SOT23	BSS138	Fairchild
1	1	Q5	BSS84	MOSFET, P-ch, 50-V, 130-mA, 10-Ohms	SOT23	BSS84	Fairchild
3	3	R1, R26, R27	300K 0.1%	Resistor, Chip, 0.1W, 0.1%, 25 ppm	0603	RG1608P-304-B-T5	SSM
1	1	R2	100K	Resistor, Chip, 1/16-W, 1%	0402	Std	Std
2	2	R3, R41	27K	Resistor, Chip, 1/16-W, 5%	0402	Std	Std
1	1	R4	165K	Resistor, Chip, 1/16-W, 1%	0402	Std	Std
8	8	R5, R6, R13, R14, R34-R37	100	Resistor, Chip, 1/16W, 5%	0603	Std	Any
1	1	R7	2M	Resistor, Chip, 1/16-W, 5%	0402	Std	Std
14	14	R8-R12, R15-R20, R22-R24	1.5K	Resistor, Chip, 1/16-W, 5%	0402	Std	Std
1	1	R21	220K	Resistor, Chip, 1/16-W, 5%	0402	Std	Std
1	1	R25	200	Resistor, Chip, 1/16W, 5%	0603	Std	Any
1	1	R28	16.5K .1%	Resistor, Chip, 0.1W, 0.1%, 25 ppm	0603	RG1608P-1652-B-T5	SSM
2	2	R29, R31	10K	Resistor, Chip, 1/16-W, 5%	0402	Std	Std
1	1	R30	.010 75ppm	Resistor, Chip, 1/2W, 1%, 75ppm	2010	WSL2010R0100FEA	Dale
2	2	R32, R33	1M	Resistor, Chip, 1/16-W, 5%	0402	Std	Std
1	1	R38	1k	Resistor, Chip, 1/16-W, 5%	402	Std	Std
2	2	R39-40	47	Resistor, Chip, 1/16-W, 5%	402	Std	Std
1	1	RT1	10K	Thermistor, NTC, 3-A	0.095 X 0.150 inch	103AT-2	Semitec
1	1	SW1	EVQ-PLHA15	Switch, Push button, Momentary, N.O. Low Profile	0.200 x 0.200 inch	EVQ-PLHA15	Panasonic

Table 2. bq34z110EVM Bill of Materials (continued)

Count		RefDes	Value	Description	Size	Part Number	MFR
-001	-002						
2	2	TB1, TB3	ED555/3DS	Terminal Block, 3-pin, 6A, 3.5mm	0.41 x 0.25 inch	ED555/3DS	OST
1	1	TP1	Vscale Hi	Test Point, Black, Thru Hole Color Keyed	0.100 x 0.100 inch	5001	Keystone
1	1	TP2	Vscale Lo	Test Point, Black, Thru Hole Color Keyed	0.100 x 0.100 inch	5001	Keystone
0	0	TP3-TP8	STD	Test Point, 0.020 Hole		Std	Std
2	2	U1, U3	SN74HC164PW	IC, 8-Bit Parallel-Out Serial Shift Registers	TSSOP-14	SN74HC164PW	TI
1	0	U2	BQ34Z100PW	IC, Gas Gauge	TSSOP	BQ34Z100PW	
0	1	U2	BQ34Z110PW	IC, Gas Gauge	TSSOP	BQ34Z110PW	
1	1	—		PCB, 68 mm x 50 mm x 1 mm		PWR111	Any
			CONNECTOR				
2	2	J4 mate		Connector, Female, 0.100 Centers	Molex	22-01-3047	
8	8	N/A		Terminals, Crimp, Tin	Molex	05-50-0114	
		N/A		Wire, Insulated 24 Awg, Red, 18 inches (+/-3 inches) (USB_5V)	Alpha	1854-3	
		N/A		Wire, Insulated 24 Awg, White, 18 inches (+/-3 inches) (SCL)	Alpha	1854-1	
		N/A		Wire, Insulated 24 Awg, Black, 18 inches (+/-3 inches) (GND)	Alpha	1854-2	
		N/A		Wire, Insulated 24 Awg, Brown, 18 inches (+/-3 inches) (SDA)	Alpha	1854-7	
1	1	N/A		Heatshrink 1"	Any	Any	

last row

Notes: 1. These assemblies are ESD sensitive, observe ESD precautions.
 2. These assemblies must be clean and free from flux and all contaminants. Use of no-clean flux is not acceptable.
 3. These assemblies must comply with workmanship standards IPC-A-610 Class 2.
 4. Reference designators marked with an asterisk (***) cannot be substituted. All other components can be substituted with equivalent MFG's components.
 5. Make one SMBus connector wire assembly for each assembly produced, from J4 mate, 4-24 Awg wires and crimp terminals. Wire colors for pin numbers are listed below. Place a J4 mate on each end of the wire assembly.
 6. Install label after final wash. Make text 8 pt font and exactly as shown in the **Assembly Number Label** table below

Assembly Number	Text
PWR111-001	BQ34Z100EVM
PWR111-002	BQ34Z100EVM

4.3 **bq34z110 Circuit Module Performance Specification Summary**

This section summarizes the performance specifications of the bq34z110 circuit module.

Table 3. Performance Specification Summary

Specification	Min	Typ	Max	Units
Input voltage BAT+ to BAT- in ≤ 5 -V mode	2.7	4	5	V
Input voltage BAT+ to BAT- in MultiCell > 5 -V mode	5	28	50	V
Charge and discharge current	0	2	7	A

5 EVM Hardware and Software Setup

This section describes how to install the bq34z110EVM PC software and how to connect the different components of the EVM.

5.1 System Requirements

The bq34z110EVSW requires Windows 2000, Windows XP, Windows Vista, or Windows 7.

5.2 Software Installation

NOTE: For the latest software archive, contact the Texas Instruments field representative assigned to this device.

Install the bq34z110EVSW software with the following steps:

1. Save the archive to a temporary directory.
2. Double-click the executable filename and follow the installer instructions to complete the bq34z110 EVSW installation.
If the EV2300 or EV2400 was not previously installed: After bq34z110 EVSW installation, a TI USB DRIVER INSTALLER pops up. Click Yes for the agreement message and follow its instructions.
3. Plug the EV2300 or EV2400 into a USB port.

5.3 Troubleshooting Unexpected Dialog Boxes

Users downloading the files must be logged in as the administrator, or must have privileges to install new programs.

The driver is not signed, so the administrator must allow installation of unsigned drivers.

5.4 Hardware Connection

The bq34z110EVM comprises two hardware components: the bq34z110 circuit module and either the EV2300 or EV2400 PC-interface box.

5.4.1 Connecting the bq34z110 Circuit Module to a Battery Pack

Figure 8 shows how to connect the bq34z110 circuit module to the cells and system load and charger.

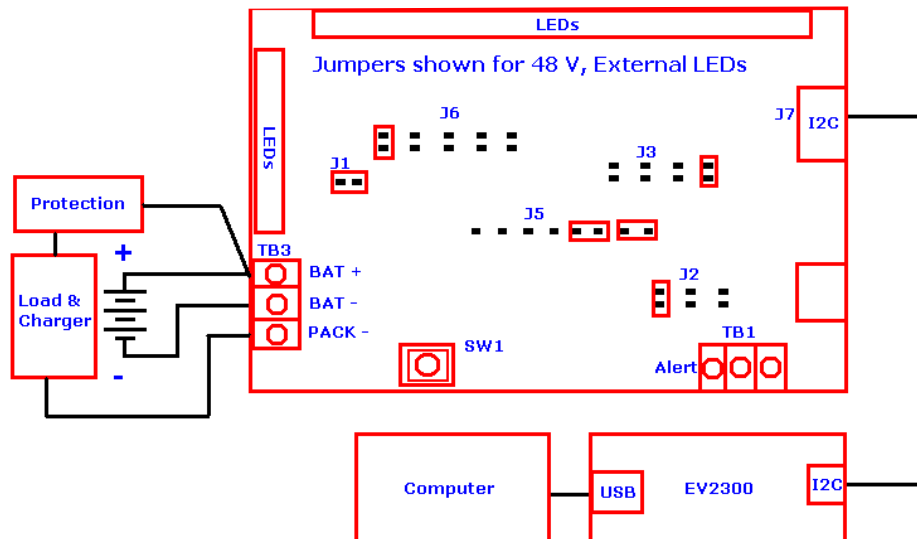

Figure 8. bq34z110 Circuit Module Connection to Cells and System Load and Charger

5.4.2 PC Interface Connection

Configure the hardware to interface with the PC by doing the following:

1. Connect the bq34z110 device-based smart battery to the EV2300 or EV2400 using the provided cable or the connections shown in Table 4.

Table 4. Circuit Module to EV2300 or EV2400 Connections

bq34z110 Device-Based Battery	EV2300
SDA	I ² C SDA
SCL	I ² C SCL
GND	GND

2. Connect the PC USB cable to the EV2300 or EV2400 and the PC USB port.

The bq34z110EVM-001 is now set up for operation.

5.5 Operation

This section details the operation of the bq34z110 EVSW software.

NOTE: Neither the EV2300 or EV2400 driver supports Windows Sleep or Hibernate states. If communicating with the EV2300 or EV2400 or the EVM presents a problem, unplug the USB cable and then plug it back in.

5.5.1 Starting the Program

With the EV2300 or EV2400 and the bq34z110EVM connected to the computer, run bq34z110 EVSW from the Desktop Icon or Start | All Programs | Texas Instruments | bq Evaluation Software menu sequence. The *Data RAM Screen* appears. Data begins to appear once the **Refresh** (single time scan) button is clicked, or when the **Keep Scanning** check box is checked. To disable the scan feature, deselect **Keep Scanning**.

The continuous scanning period can be set using the *Options* and *Set Scan Interval* menu selections. The range for this interval is 0 ms to 65535 ms. Only items that are selected for scanning are scanned within this period.

The bq34z110 EVSW provides a logging function that logs the values that were last scanned by the EVSW. To enable this function, click the **Start Logging** button; this causes the **Keep Scanning** button to be selected. When logging is *Stopped*, the **Keep Scanning** button is still selected and must be manually unchecked.

The logging interval is specified under the *Options* menu with the maximum value of 65535 ms. The *Log* interval cannot be smaller than the scan interval because this results in the same value being logged at least twice.

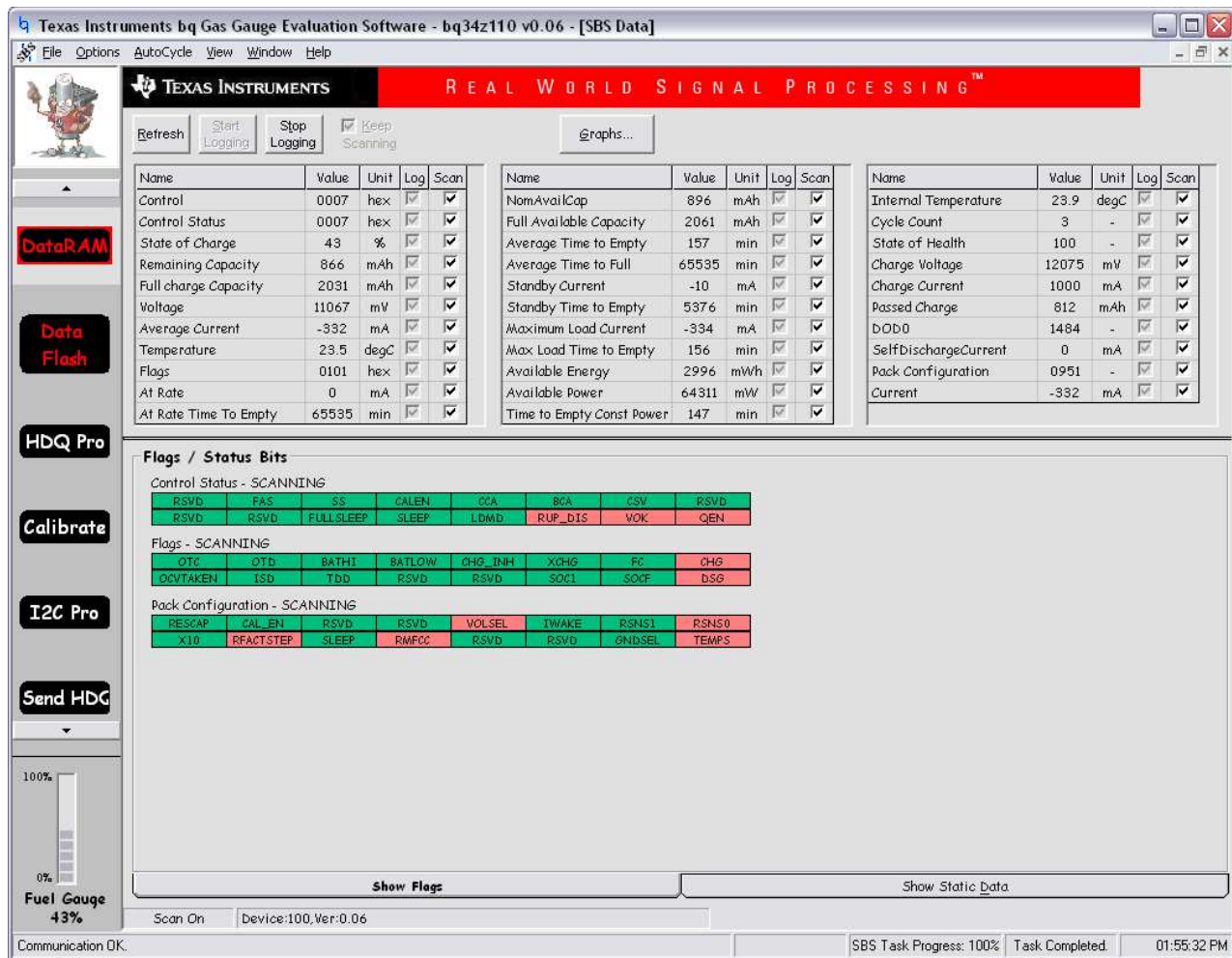

Figure 9. Data RAM Screen

Figure 9 shows the Data RAM set along with additional `ManuManufacturersAccess()` command information, such as individual cell measurements.

Dragging the splitter bar, the line that separates the Flags/Static data from Data RAM values, changes the height of the *Flags/Static Data* display. Selecting **View** then **Auto Arrange** returns the splitter bar to its original location.

5.5.2 Setting Programmable bq34z110 Options

The bq34z110 data flash comes configured according to the default settings detailed in the *bq34z110 Wide Range Fuel Gauge with Impedance Track™ Technology Datasheet* ([SLUSB55](#)). Ensure that the settings are correctly changed to match the pack and application for the bq34z110 solution being evaluated.

NOTE: Set these options correctly to get the best performance.

Use [Figure 10](#), the *Data Flash Screen* to configure the settings.

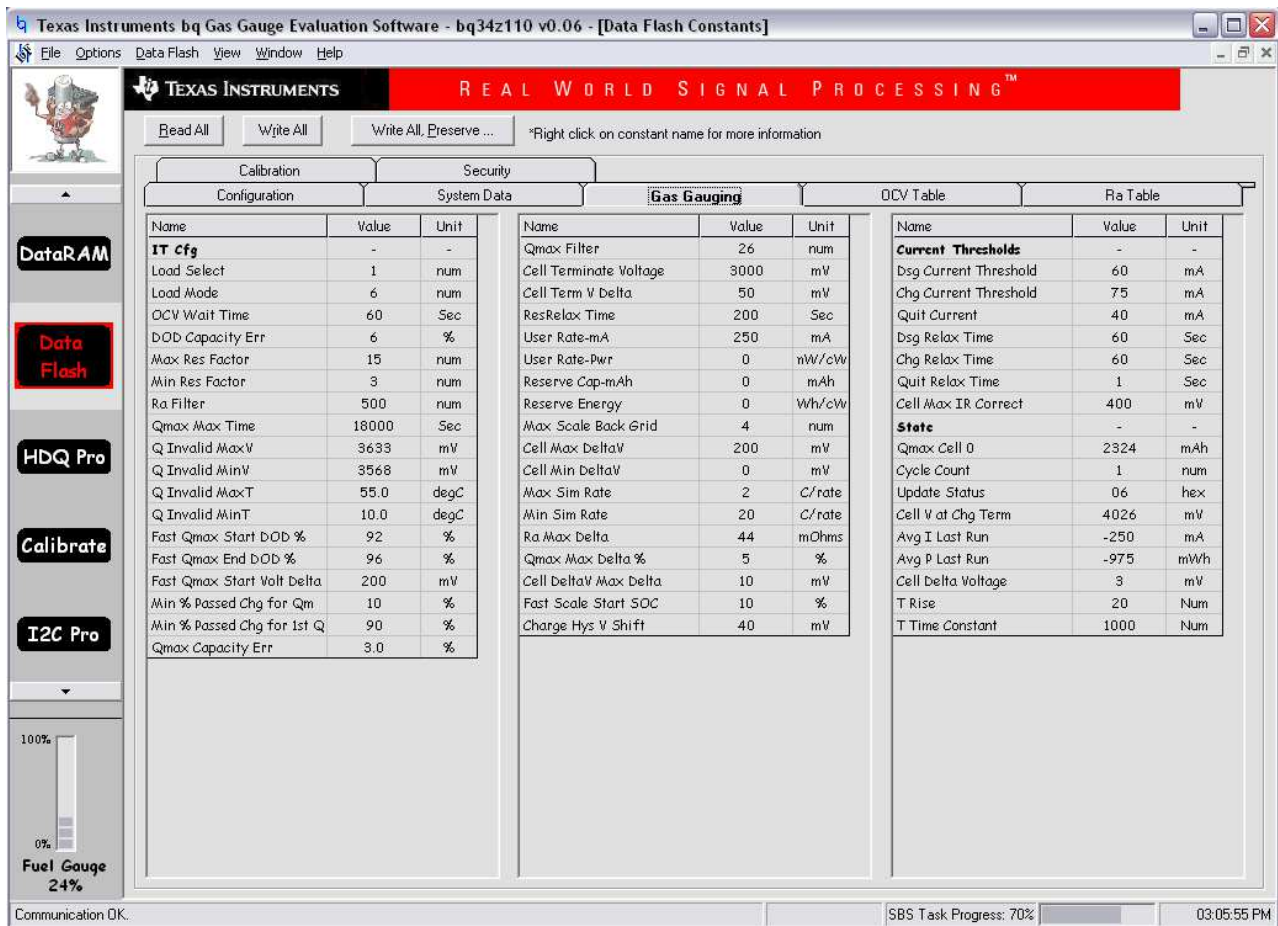

Configuration

Name	Value	Unit
IT Cfg	-	-
Load Select	1	num
Load Mode	6	num
OCV Wait Time	60	Sec
DOD Capacity Err	6	%
Max Res Factor	15	num
Min Res Factor	3	num
Ra Filter	500	num
Qmax Max Time	18000	Sec
Q Invalid MaxV	3633	mV
Q Invalid MinV	3568	mV
Q Invalid MaxT	55.0	degC
Q Invalid MinT	10.0	degC
Fast Qmax Start DOD %	92	%
Fast Qmax End DOD %	96	%
Fast Qmax Start Volt Delta	200	mV
Min % Passed Chg for Qm	10	%
Min % Passed Chg for 1st Q	90	%
Qmax Capacity Err	3.0	%

Gas Gauging

Name	Value	Unit
Qmax Filter	26	num
Cell Terminate Voltage	3000	mV
Cell Term V Delta	50	mV
ResRelax Time	200	Sec
User Rate-mA	250	mA
User Rate-Pwr	0	mW/cW
Reserve Cap-mAh	0	mAh
Reserve Energy	0	Wh/cW
Max Scale Back Grid	4	num
Cell Max DeltaV	200	mV
Cell Min DeltaV	0	mV
Max Sim Rate	2	C/rate
Min Sim Rate	20	C/rate
Ra Max Delta	44	mOhms
Qmax Max Delta %	5	%
Cell DeltaV Max Delta	10	mV
Fast Scale Start SOC	10	%
Charge Hys V Shift	40	mV

OCY Table

Name	Value	Unit
Current Thresholds	-	-
Dsg Current Threshold	60	mA
Chg Current Threshold	75	mA
Quit Current	40	mA
Dsg Relax Time	60	Sec
Chg Relax Time	60	Sec
Quit Relax Time	1	Sec
Cell Max IR Correct	-400	mV
State	-	-
Qmax Cell 0	2324	mAh
Cycle Count	1	num
Update Status	06	hex
Cell V at Chg Term	4026	mV
Avg I Last Run	-250	mA
Avg P Last Run	-975	mW/h
Cell Delta Voltage	3	mV
T Rise	20	Num
T Time Constant	1000	Num

Communication OK. SBS Task Progress: 70% 03:05:55 PM

Figure 10. Data Flash Screen, Gas Gauging Class

Click on menu option | **Data Flash** | **Read All** | to read all the data from the bq34z110 data flash.

Write to a data flash location by clicking on the desired location and entering the data. Clicking **Enter** writes the entire tab of flash data. Writing to a data flash location can also be accomplished by selecting menu option | **Data Flash** | **Write All** |. The data flash must be read before any writes are performed to avoid having incorrect data written to the device.

The | **File** | **Special Export** | menu option allows the data flash to be exported.

Save the data flash configuration to a file by selecting | **File** | **Export** | and entering a file name. A data flash file also can be retrieved in this way, imported, and written to the bq34z110 using the **Write All** button.

The configuration information of the bq34z110 data is held in the data flash.

The bq34z110 allows for an automatic data flash export function, similar to the **Data RAM logging** function. This feature, when selected using | **Options** | **Auto Export** |, exports data flash to a sequential series of files named *FilenameNNNNN.gg*; where N = a decimal number from 0 to 9.

The AutoExport interval is set under the | **Options menu** | with a minimum value of 15 s. The AutoExport filename is set under the | **Options menu** |.

When a check is next to | **AutoExport** |, the AutoExport is in progress. The same menu selection is used to turn AutoExport on and off.

If the data-flash screen is blank, the bq34z110 used may not be supported by the bqEVSW version in use. An upgrade may be required.

5.6 Calibration Screen

5.6.1 How to Calibrate

Calibrate the bq34z110 using appropriate floating power supplies before the cells are attached. Complete the following before the bq34z110 is calibrated:

- Connect and measure a 1- to 2-A stable current source from BAT(–) to PACK(–). The positive lead from the current source is connected to PACK(–) simulating a discharge current.
- Connect and measure a stable voltage source from BAT(+) to BAT(–).
- Measure the temperature near the thermistor.

Whether all of the preceding steps are required depends on the type of calibration being performed.

5.6.2 Calibrating the bq34z110

Calibrate the bq34z110 using the following sequential steps:

1. Select the types of calibration to be performed.
2. Enter the measured values for the types of calibration selected (except for offset calibrations).
3. If *Temperature Calibration* is selected, select the sensor that is to be calibrated.
4. Click the appropriate button to initiate calibration.

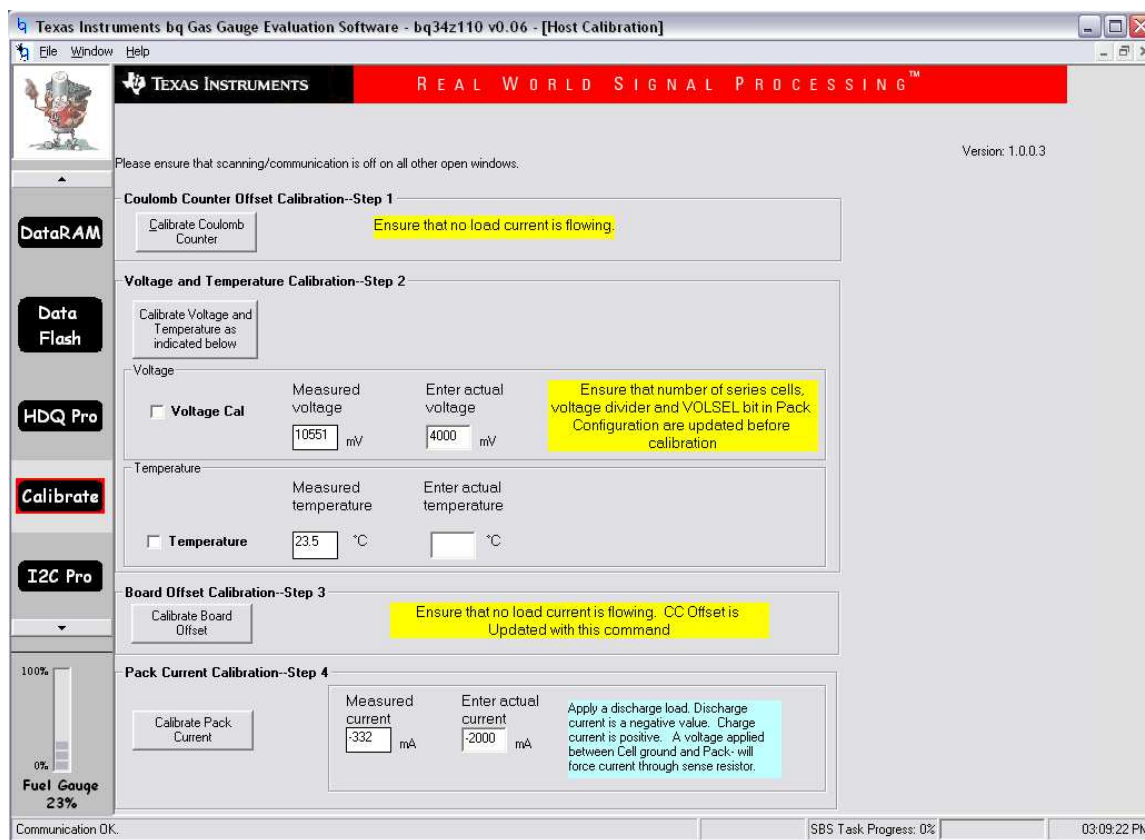

Figure 11. Calibration Screen

5.7 I²C Pro (Advanced) Screen

5.7.1 I²C Communication

The set of read and write operations over I²C bus are not specific to any gas gauge. These are provided as general-purpose communication tools.

5.7.2 Reprogramming

Reprogram the device using the following:

- Ensure that the gauge is in *Full Access* mode. The SS and FAS flags in the Control Status register must both be unasserted (Green). If not, use the appropriate data block codes to command (0x00) to clear the flags. Type default codes of 0414,3672 into the *Write I2C Data Block* feature to unseal and ffff, ffff for full access, or into the value field of the control register on the Data Ram screen followed by pressing *Enter*. Stop the scan during this operation to ensure the words are received consecutively.
- With scanning enabled, using the *Write I2C Data Block* feature commands the gauge to stop executing and enter ROM mode. Send data block code 0x000f to command 0x00. If successful, the status at the bottom of the screen changes from *Communication OK* to *Communication Error*.
- Use the file browser button to locate the desired .senc file, press the **Program** button.
- When programming is complete, pushing the **Execute** button initiates program execution. Within a few seconds *Communication OK* appears in the status area.
- Close and re-open the Evaluation Software to ensure data file synchronization.

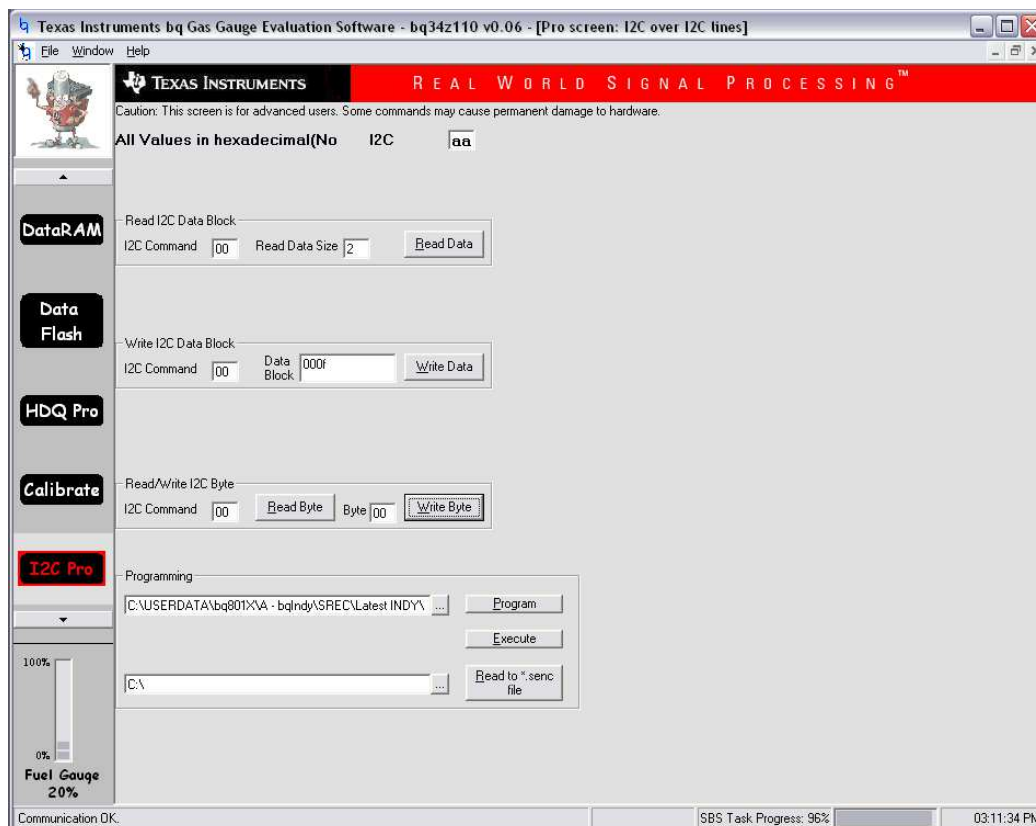

Figure 12. I²C Pro (Advanced) Screen

5.8 Send HDQ Screen

When using the HDQ single wire serial communication feature, the mode of the gauge must be changed with a special command. This screen provides a button for this purpose. Note the warning message. The process is not reversible. Once in HDQ mode, the HDQ pro screen is available for testing commands and reprogramming the device. For register scanning and data flash access, use the companion evaluation program for HDQ.

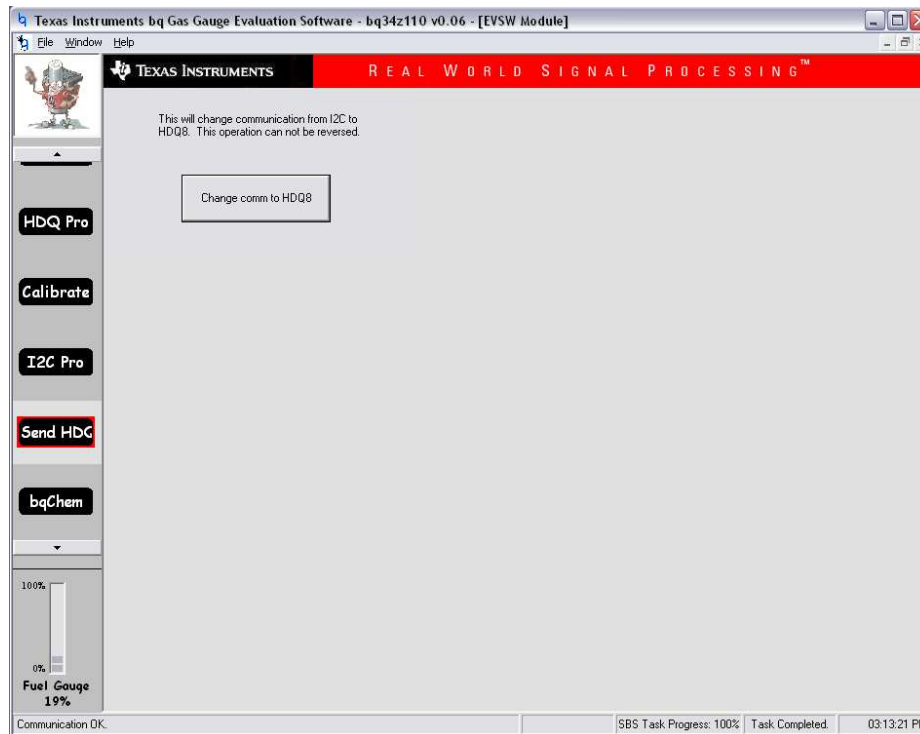

Figure 13. Send HDQ Screen

5.9 bqChem

bqChem provides access to the library of previously characterized Lithium-Ion cell chemistries. bqChem also lets you program the chemical database into the gauge. Users can sort by chemical ID or by cell manufacturer. For help identifying the chemistry for the cells, contact the Texas Instruments field representative.

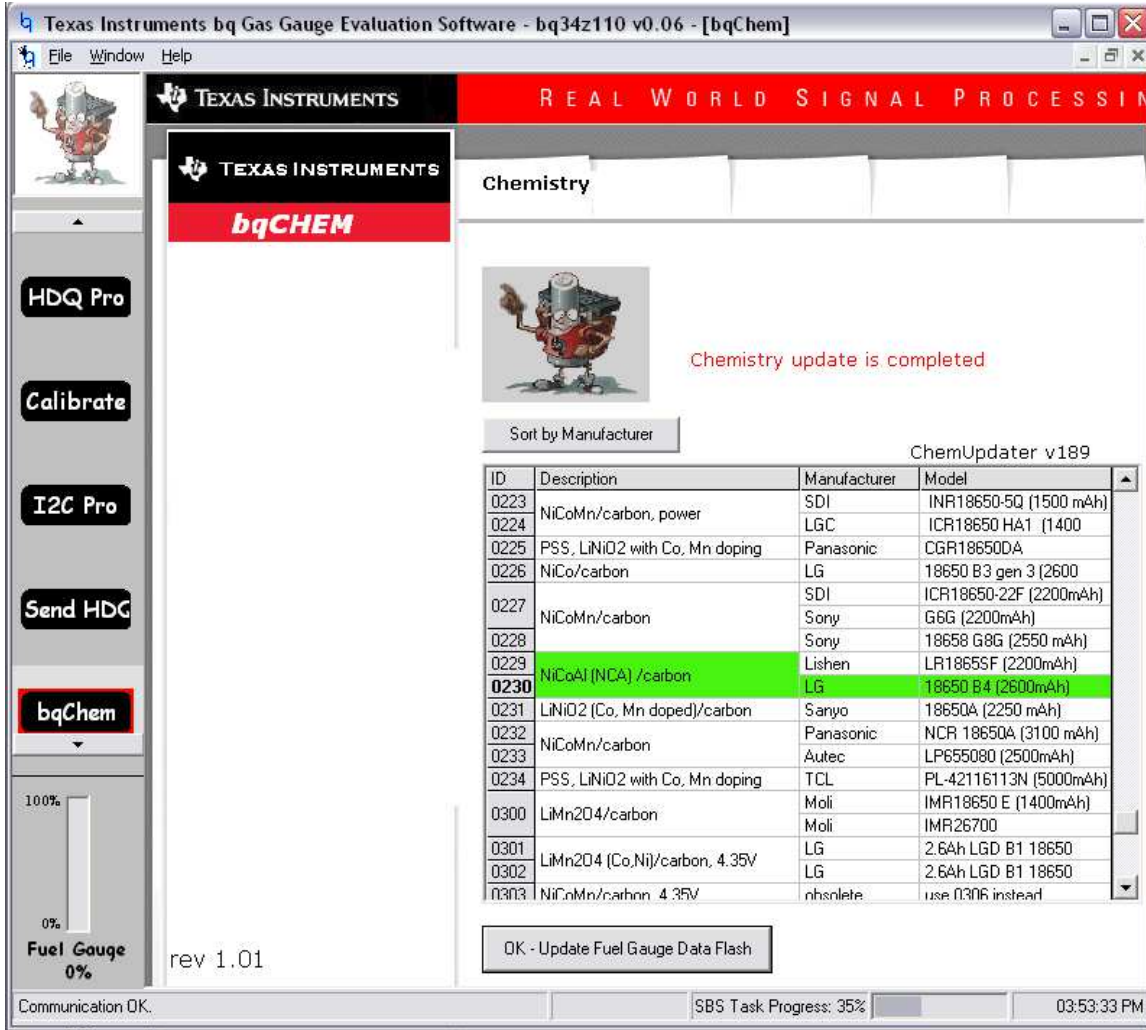

Figure 14. bqChem Screen

5.10 Related Documentation from Texas Instruments

For related documentation, contact the TI field representative.

Documents:

- bq34z110/bq30z55-R1 SBS 1.1-Compliant Gas Gauge With Impedance Track™ Datasheet*
- EV2300 EVM Interface Board User's Guide*
- EV2400 EVM Interface Board User's Guide*

Literature Number:

- [SLUSB55](#)
- [SLUU159](#)
- [SLUU446](#)

EVALUATION BOARD/KIT/MODULE (EVM) ADDITIONAL TERMS

Texas Instruments (TI) provides the enclosed Evaluation Board/Kit/Module (EVM) under the following conditions:

The user assumes all responsibility and liability for proper and safe handling of the goods. Further, the user indemnifies TI from all claims arising from the handling or use of the goods.

Should this evaluation board/kit not meet the specifications indicated in the User's Guide, the board/kit may be returned within 30 days from the date of delivery for a full refund. THE FOREGOING LIMITED WARRANTY IS THE EXCLUSIVE WARRANTY MADE BY SELLER TO BUYER AND IS IN LIEU OF ALL OTHER WARRANTIES, EXPRESSED, IMPLIED, OR STATUTORY, INCLUDING ANY WARRANTY OF MERCHANTABILITY OR FITNESS FOR ANY PARTICULAR PURPOSE. EXCEPT TO THE EXTENT OF THE INDEMNITY SET FORTH ABOVE, NEITHER PARTY SHALL BE LIABLE TO THE OTHER FOR ANY INDIRECT, SPECIAL, INCIDENTAL, OR CONSEQUENTIAL DAMAGES.

Please read the User's Guide and, specifically, the Warnings and Restrictions notice in the User's Guide prior to handling the product. This notice contains important safety information about temperatures and voltages. For additional information on TI's environmental and/or safety programs, please visit www.ti.com/esh or contact TI.

No license is granted under any patent right or other intellectual property right of TI covering or relating to any machine, process, or combination in which such TI products or services might be or are used. TI currently deals with a variety of customers for products, and therefore our arrangement with the user is not exclusive. TI assumes no liability for applications assistance, customer product design, software performance, or infringement of patents or services described herein.

REGULATORY COMPLIANCE INFORMATION

As noted in the EVM User's Guide and/or EVM itself, this EVM and/or accompanying hardware may or may not be subject to the Federal Communications Commission (FCC) and Industry Canada (IC) rules.

For EVMs **not** subject to the above rules, this evaluation board/kit/module is intended for use for ENGINEERING DEVELOPMENT, DEMONSTRATION OR EVALUATION PURPOSES ONLY and is not considered by TI to be a finished end product fit for general consumer use. It generates, uses, and can radiate radio frequency energy and has not been tested for compliance with the limits of computing devices pursuant to part 15 of FCC or ICES-003 rules, which are designed to provide reasonable protection against radio frequency interference. Operation of the equipment may cause interference with radio communications, in which case the user at his own expense will be required to take whatever measures may be required to correct this interference.

General Statement for EVMs including a radio

User Power/Frequency Use Obligations: This radio is intended for development/professional use only in legally allocated frequency and power limits. Any use of radio frequencies and/or power availability of this EVM and its development application(s) must comply with local laws governing radio spectrum allocation and power limits for this evaluation module. It is the user's sole responsibility to only operate this radio in legally acceptable frequency space and within legally mandated power limitations. Any exceptions to this are strictly prohibited and unauthorized by Texas Instruments unless user has obtained appropriate experimental/development licenses from local regulatory authorities, which is responsibility of user including its acceptable authorization.

For EVMs annotated as FCC – FEDERAL COMMUNICATIONS COMMISSION Part 15 Compliant

Caution

This device complies with part 15 of the FCC Rules. Operation is subject to the following two conditions: (1) This device may not cause harmful interference, and (2) this device must accept any interference received, including interference that may cause undesired operation.

Changes or modifications not expressly approved by the party responsible for compliance could void the user's authority to operate the equipment.

FCC Interference Statement for Class A EVM devices

This equipment has been tested and found to comply with the limits for a Class A digital device, pursuant to part 15 of the FCC Rules. These limits are designed to provide reasonable protection against harmful interference when the equipment is operated in a commercial environment. This equipment generates, uses, and can radiate radio frequency energy and, if not installed and used in accordance with the instruction manual, may cause harmful interference to radio communications. Operation of this equipment in a residential area is likely to cause harmful interference in which case the user will be required to correct the interference at his own expense.

FCC Interference Statement for Class B EVM devices

This equipment has been tested and found to comply with the limits for a Class B digital device, pursuant to part 15 of the FCC Rules. These limits are designed to provide reasonable protection against harmful interference in a residential installation. This equipment generates, uses and can radiate radio frequency energy and, if not installed and used in accordance with the instructions, may cause harmful interference to radio communications. However, there is no guarantee that interference will not occur in a particular installation. If this equipment does cause harmful interference to radio or television reception, which can be determined by turning the equipment off and on, the user is encouraged to try to correct the interference by one or more of the following measures:

- Reorient or relocate the receiving antenna.
- Increase the separation between the equipment and receiver.
- Connect the equipment into an outlet on a circuit different from that to which the receiver is connected.
- Consult the dealer or an experienced radio/TV technician for help.

For EVMs annotated as IC – INDUSTRY CANADA Compliant

This Class A or B digital apparatus complies with Canadian ICES-003.

Changes or modifications not expressly approved by the party responsible for compliance could void the user's authority to operate the equipment.

Concerning EVMs including radio transmitters

This device complies with Industry Canada licence-exempt RSS standard(s). Operation is subject to the following two conditions: (1) this device may not cause interference, and (2) this device must accept any interference, including interference that may cause undesired operation of the device.

Concerning EVMs including detachable antennas

Under Industry Canada regulations, this radio transmitter may only operate using an antenna of a type and maximum (or lesser) gain approved for the transmitter by Industry Canada. To reduce potential radio interference to other users, the antenna type and its gain should be so chosen that the equivalent isotropically radiated power (e.i.r.p.) is not more than that necessary for successful communication.

This radio transmitter has been approved by Industry Canada to operate with the antenna types listed in the user guide with the maximum permissible gain and required antenna impedance for each antenna type indicated. Antenna types not included in this list, having a gain greater than the maximum gain indicated for that type, are strictly prohibited for use with this device.

Cet appareil numérique de la classe A ou B est conforme à la norme NMB-003 du Canada.

Les changements ou les modifications pas expressément approuvés par la partie responsable de la conformité ont pu vider l'autorité de l'utilisateur pour actionner l'équipement.

Concernant les EVMs avec appareils radio

Le présent appareil est conforme aux CNR d'Industrie Canada applicables aux appareils radio exempts de licence. L'exploitation est autorisée aux deux conditions suivantes : (1) l'appareil ne doit pas produire de brouillage, et (2) l'utilisateur de l'appareil doit accepter tout brouillage radioélectrique subi, même si le brouillage est susceptible d'en compromettre le fonctionnement.

Concernant les EVMs avec antennes détachables

Conformément à la réglementation d'Industrie Canada, le présent émetteur radio peut fonctionner avec une antenne d'un type et d'un gain maximal (ou inférieur) approuvé pour l'émetteur par Industrie Canada. Dans le but de réduire les risques de brouillage radioélectrique à l'intention des autres utilisateurs, il faut choisir le type d'antenne et son gain de sorte que la puissance isotrope rayonnée équivalente (p.i.r.e.) ne dépasse pas l'intensité nécessaire à l'établissement d'une communication satisfaisante.

Le présent émetteur radio a été approuvé par Industrie Canada pour fonctionner avec les types d'antenne énumérés dans le manuel d'usage et ayant un gain admissible maximal et l'impédance requise pour chaque type d'antenne. Les types d'antenne non inclus dans cette liste, ou dont le gain est supérieur au gain maximal indiqué, sont strictement interdits pour l'exploitation de l'émetteur.

【Important Notice for Users of this Product in Japan】

This development kit is NOT certified as Confirming to Technical Regulations of Radio Law of Japan

If you use this product in Japan, you are required by Radio Law of Japan to follow the instructions below with respect to this product:

1. Use this product in a shielded room or any other test facility as defined in the notification #173 issued by Ministry of Internal Affairs and Communications on March 28, 2006, based on Sub-section 1.1 of Article 6 of the Ministry's Rule for Enforcement of Radio Law of Japan,
2. Use this product only after you obtained the license of Test Radio Station as provided in Radio Law of Japan with respect to this product, or
3. Use of this product only after you obtained the Technical Regulations Conformity Certification as provided in Radio Law of Japan with respect to this product. Also, please do not transfer this product, unless you give the same notice above to the transferee. Please note that if you could not follow the instructions above, you will be subject to penalties of Radio Law of Japan.

Texas Instruments Japan Limited
(address) 24-1, Nishi-Shinjuku 6 chome, Shinjuku-ku, Tokyo, Japan

<http://www.tij.co.jp>

【ご使用にあたっての注】

本開発キットは技術基準適合証明を受けておりません。

本製品のご使用に際しては、電波法遵守のため、以下のいずれかの措置を取っていただく必要がありますのでご注意ください。

1. 電波法施行規則第6条第1項第1号に基づく平成18年3月28日総務省告示第173号で定められた電波暗室等の試験設備でご使用いただく。
2. 実験局の免許を取得後ご使用いただく。
3. 技術基準適合証明を取得後ご使用いただく。

なお、本製品は、上記の「ご使用にあたっての注意」を譲渡先、移転先に通知しない限り、譲渡、移転できないものとします。

上記を遵守頂けない場合は、電波法の罰則が適用される可能性があることをご留意ください。

日本テキサス・インスツルメンツ株式会社
東京都新宿区西新宿6丁目24番1号
西新宿三井ビル

<http://www.tij.co.jp>

EVALUATION BOARD/KIT/MODULE (EVM) WARNINGS, RESTRICTIONS AND DISCLAIMERS

For Feasibility Evaluation Only, in Laboratory/Development Environments. Unless otherwise indicated, this EVM is not a finished electrical equipment and not intended for consumer use. It is intended solely for use for preliminary feasibility evaluation in laboratory/development environments by technically qualified electronics experts who are familiar with the dangers and application risks associated with handling electrical mechanical components, systems and subsystems. It should not be used as all or part of a finished end product.

Your Sole Responsibility and Risk. You acknowledge, represent and agree that:

1. You have unique knowledge concerning Federal, State and local regulatory requirements (including but not limited to Food and Drug Administration regulations, if applicable) which relate to your products and which relate to your use (and/or that of your employees, affiliates, contractors or designees) of the EVM for evaluation, testing and other purposes.
2. You have full and exclusive responsibility to assure the safety and compliance of your products with all such laws and other applicable regulatory requirements, and also to assure the safety of any activities to be conducted by you and/or your employees, affiliates, contractors or designees, using the EVM. Further, you are responsible to assure that any interfaces (electronic and/or mechanical) between the EVM and any human body are designed with suitable isolation and means to safely limit accessible leakage currents to minimize the risk of electrical shock hazard.
3. You will employ reasonable safeguards to ensure that your use of the EVM will not result in any property damage, injury or death, even if the EVM should fail to perform as described or expected.
4. You will take care of proper disposal and recycling of the EVM's electronic components and packing materials.

Certain Instructions. It is important to operate this EVM within TI's recommended specifications and environmental considerations per the user guidelines. Exceeding the specified EVM ratings (including but not limited to input and output voltage, current, power, and environmental ranges) may cause property damage, personal injury or death. If there are questions concerning these ratings please contact a TI field representative prior to connecting interface electronics including input power and intended loads. Any loads applied outside of the specified output range may result in unintended and/or inaccurate operation and/or possible permanent damage to the EVM and/or interface electronics. Please consult the EVM User's Guide prior to connecting any load to the EVM output. If there is uncertainty as to the load specification, please contact a TI field representative. During normal operation, some circuit components may have case temperatures greater than 60°C as long as the input and output are maintained at a normal ambient operating temperature. These components include but are not limited to linear regulators, switching transistors, pass transistors, and current sense resistors which can be identified using the EVM schematic located in the EVM User's Guide. When placing measurement probes near these devices during normal operation, please be aware that these devices may be very warm to the touch. As with all electronic evaluation tools, only qualified personnel knowledgeable in electronic measurement and diagnostics normally found in development environments should use these EVMs.

Agreement to Defend, Indemnify and Hold Harmless. You agree to defend, indemnify and hold TI, its licensors and their representatives harmless from and against any and all claims, damages, losses, expenses, costs and liabilities (collectively, "Claims") arising out of or in connection with any use of the EVM that is not in accordance with the terms of the agreement. This obligation shall apply whether Claims arise under law of tort or contract or any other legal theory, and even if the EVM fails to perform as described or expected.

Safety-Critical or Life-Critical Applications. If you intend to evaluate the components for possible use in safety critical applications (such as life support) where a failure of the TI product would reasonably be expected to cause severe personal injury or death, such as devices which are classified as FDA Class III or similar classification, then you must specifically notify TI of such intent and enter into a separate Assurance and Indemnity Agreement.

Mailing Address: Texas Instruments, Post Office Box 655303, Dallas, Texas 75265
Copyright © 2012, Texas Instruments Incorporated

IMPORTANT NOTICE

Texas Instruments Incorporated and its subsidiaries (TI) reserve the right to make corrections, enhancements, improvements and other changes to its semiconductor products and services per JESD46, latest issue, and to discontinue any product or service per JESD48, latest issue. Buyers should obtain the latest relevant information before placing orders and should verify that such information is current and complete. All semiconductor products (also referred to herein as "components") are sold subject to TI's terms and conditions of sale supplied at the time of order acknowledgment.

TI warrants performance of its components to the specifications applicable at the time of sale, in accordance with the warranty in TI's terms and conditions of sale of semiconductor products. Testing and other quality control techniques are used to the extent TI deems necessary to support this warranty. Except where mandated by applicable law, testing of all parameters of each component is not necessarily performed.

TI assumes no liability for applications assistance or the design of Buyers' products. Buyers are responsible for their products and applications using TI components. To minimize the risks associated with Buyers' products and applications, Buyers should provide adequate design and operating safeguards.

TI does not warrant or represent that any license, either express or implied, is granted under any patent right, copyright, mask work right, or other intellectual property right relating to any combination, machine, or process in which TI components or services are used. Information published by TI regarding third-party products or services does not constitute a license to use such products or services or a warranty or endorsement thereof. Use of such information may require a license from a third party under the patents or other intellectual property of the third party, or a license from TI under the patents or other intellectual property of TI.

Reproduction of significant portions of TI information in TI data books or data sheets is permissible only if reproduction is without alteration and is accompanied by all associated warranties, conditions, limitations, and notices. TI is not responsible or liable for such altered documentation. Information of third parties may be subject to additional restrictions.

Resale of TI components or services with statements different from or beyond the parameters stated by TI for that component or service voids all express and any implied warranties for the associated TI component or service and is an unfair and deceptive business practice. TI is not responsible or liable for any such statements.

Buyer acknowledges and agrees that it is solely responsible for compliance with all legal, regulatory and safety-related requirements concerning its products, and any use of TI components in its applications, notwithstanding any applications-related information or support that may be provided by TI. Buyer represents and agrees that it has all the necessary expertise to create and implement safeguards which anticipate dangerous consequences of failures, monitor failures and their consequences, lessen the likelihood of failures that might cause harm and take appropriate remedial actions. Buyer will fully indemnify TI and its representatives against any damages arising out of the use of any TI components in safety-critical applications.

In some cases, TI components may be promoted specifically to facilitate safety-related applications. With such components, TI's goal is to help enable customers to design and create their own end-product solutions that meet applicable functional safety standards and requirements. Nonetheless, such components are subject to these terms.

No TI components are authorized for use in FDA Class III (or similar life-critical medical equipment) unless authorized officers of the parties have executed a special agreement specifically governing such use.

Only those TI components which TI has specifically designated as military grade or "enhanced plastic" are designed and intended for use in military/aerospace applications or environments. Buyer acknowledges and agrees that any military or aerospace use of TI components which have **not** been so designated is solely at the Buyer's risk, and that Buyer is solely responsible for compliance with all legal and regulatory requirements in connection with such use.

TI has specifically designated certain components which meet ISO/TS16949 requirements, mainly for automotive use. Components which have not been so designated are neither designed nor intended for automotive use; and TI will not be responsible for any failure of such components to meet such requirements.

Products

Audio	www.ti.com/audio
Amplifiers	amplifier.ti.com
Data Converters	dataconverter.ti.com
DLP® Products	www.dlp.com
DSP	dsp.ti.com
Clocks and Timers	www.ti.com/clocks
Interface	interface.ti.com
Logic	logic.ti.com
Power Mgmt	power.ti.com
Microcontrollers	microcontroller.ti.com
RFID	www.ti-rfid.com
OMAP Applications Processors	www.ti.com/omap
Wireless Connectivity	www.ti.com/wirelessconnectivity

Applications

Automotive and Transportation	www.ti.com/automotive
Communications and Telecom	www.ti.com/communications
Computers and Peripherals	www.ti.com/computers
Consumer Electronics	www.ti.com/consumer-apps
Energy and Lighting	www.ti.com/energy
Industrial	www.ti.com/industrial
Medical	www.ti.com/medical
Security	www.ti.com/security
Space, Avionics and Defense	www.ti.com/space-avionics-defense
Video and Imaging	www.ti.com/video
TI E2E Community	e2e.ti.com