

Compensated High Inductance Choke, 1-phase



See below:

Approvals and Compliances

Description

- Current compensated choke
- 1-phase choke
- THT-terminals
- Flange for mounting onto printed circuit board
- Fully potted resin

Applications

- Placed in front of frequency converter
- Stepper motor drives
- UPS-systems
- Inverter

References

This type is Phase-out without alternate type
 Last order date: 15.12.2018

Weblinks

[pdf data sheet](#), [html datasheet](#), [General Product Information](#), [Approvals](#), [Distributor-Stock-Check](#), [Detailed request for product](#)

Technical Data

Rated voltage	up to 540VAC	Test Voltage	2.5kV, 50Hz, 2 sec, winding to winding
	up to 760VDC	Isolation Voltage	2.5kV eff., 50Hz, 2 sec, winding to ambient
Rated Current	4 - 7 A @ Ta 40 °C	Climatic Category	25/100/21 acc. to IEC 60068-1
Rated inductance	14 - 60mH, Tol. -30% +50%	Allowable Operation Temp.	-25°C to 100°C
Power Operating Frequency	50 - 400Hz		
Terminal Type	THT		
Weight	145 - 505g		
Material: Housing	UL 94V-0		
Sealing Compound	UL 94V-0		

Approvals and Compliances

Detailed information on product approvals, code requirements, usage instructions and detailed test conditions can be looked up in [Details about Approvals](#)

SCHURTER products are designed for use in industrial environments. They have approvals from independent testing bodies according to national and international standards. Products with specific characteristics and requirements such as required in the automotive sector according to IATF 16949, medical technology according to ISO 13485 or in the aerospace industry can be offered exclusively with customer-specific, individual agreements by SCHURTER.

Approvals

The approval mark is used by the testing authorities to certify compliance with the safety requirements placed on electronic products.

Approval Reference Type: DKLL

Approval Logo	Certificates	Certification Body	Description
	UL Approvals	UL	UL File Number:





Application standards

Application standards where the product can be used

Organization	Design	Standard	Description
	Designed for applications acc.	IEC/UL 62368-1	IEC 62368-1 includes the basic requirements for safety of audio, video, information technology and office equipment.

Compliances

The product complies with following Guide Lines

Identification	Details	Initiator	Description
	CE declaration of conformity	SCHURTER AG	The CE marking declares that the product complies with the applicable requirements laid down in the harmonisation of Community legislation on its affixing in accordance with EU Regulation 765/2008.
	RoHS	SCHURTER AG	Directive RoHS 2011/65/EU, Amendment (EU) 2015/863
	China RoHS	SCHURTER AG	The law SJ / T 11363-2006 (China RoHS) has been in force since 1 March 2007. It is similar to the EU directive RoHS.
	REACH	SCHURTER AG	On 1 June 2007, Regulation (EC) No 1907/2006 on the Registration, Evaluation, Authorization and Restriction of Chemicals 1 (abbreviated as "REACH") entered into force.

Dimension [mm]

Case 31-2P

Case 46-2P

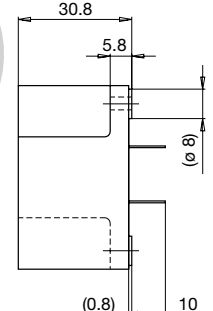
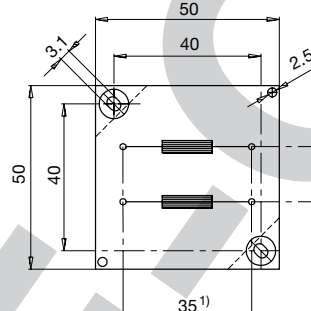
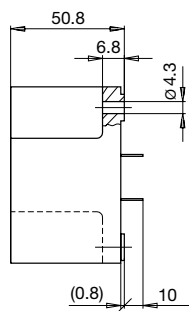
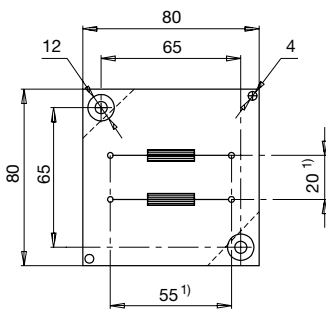

1) Spacing given at pin base

Impedance curves

DKLL-0231-xxxx

DKLL-0246-xxxx

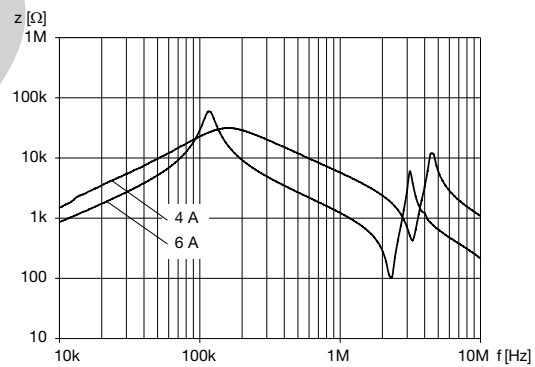
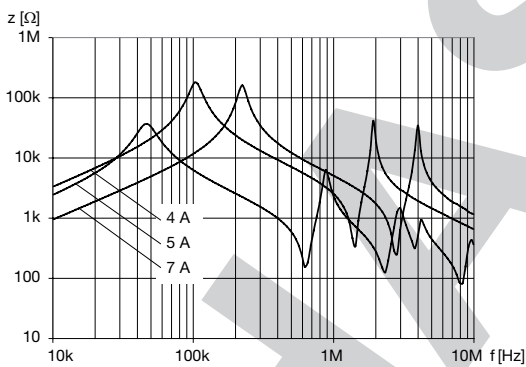

All Variants

I_n [A]	L_n [mH]	R_{cu} [mΩ]	Tripped Power Dissipation [W]	f_{RES} [MHz]	Copper ϕ [mm]	Weight [g]	Housings	Packing unit [pcs.]	Order Number
4	60	250	8	0.1	0.71	490g	31-2P	2	DKLL-0231-0460
5	40	126	6.3	0.048	0.9	490g	31-2P	2	DKLL-0231-0540
7	20	62	6	0.18	1.12	505g	31-2P	2	DKLL-0231-0720
4	30	96	3	0.2	0.8	145g	46-2P	10	DKLL-0246-0430
6	14	46	3.3	0.3	1	145g	46-2P	10	DKLL-0246-0614

Availability for all products can be searched real-time: <https://www.schurter.com/en/Stock-Check/Stock-Check-SCHURTER>