

FEATURES

- 16.8V – 160V steady state, with transient range of 14.4V – 168V for 100mS
- Output voltages of 12, 24 or 54 Volts
- Up to 300 Watts total output power
- Ruggedized and encased chassis-mount package 7.3" x 4.6" x 1.6" (185mm x 116mm x 40mm)
- Certified to Railway standards EN 50155 and EN 50121-3-2
- High efficiency up to 92%, typical
- Tight Line and Load regulation
- Low Ripple and Noise
- Extensive self-protection shut down features, including over temperature shutdown
- Output voltage adjustable
- Green LED Power Indicator
- Remote On/Off and PUL
- Optional ORing feature for redundant or parallel operation with droop
- Optional Hold-up feature
- Operating ambient temperature range -40 to +70°C (10min +85°C)

SAFETY FEATURES

- Protected against fire and smoke to EN 45545
- 4250Vdc input to output isolation
- UL 62368-1 and IEC/EN62368-1 safety approvals
- CE compliance
- Demko Certification
- RoHS compliant

Output Voltage (Vdc)	Output Current (A)	Input Voltage Range (Vdc)
12	25.0	16.8 to 160
24	12.5	16.8 to 160
54	5.5	16.8 to 160

Optimized for harsh environments in industrial/railway applications, the IRV300 DC-DC converter series offer regulated outputs in a ruggedized, encased chassis-mount package.

PRODUCT OVERVIEW

The IRV300 series is a 300W stand alone, system level, chassis mount isolated DC-DC converter. The converter features an ultra wide input designed to accept nominal battery voltages from 24V to 110V in a single product.

The IRV300 is ideally suited for Railway applications, meeting EN50155 standard in a single package. The output voltage has a wide trim range up to +15% of Vnom, and features a constant current output profile ideally suited for high inductive/capacitive loading.

They feature Programmable Undervoltage Lock-out (PUL) to prevent deep discharge of the input

batteries, Remote On/Off control and an Open Collector DC Output Power Good Signal including a visual LED as standard.

The IRV300 offer additional options such as "Hold Up" capability for overriding load dependent input interruptions of 10mS to 20mS not affecting the output and "ORing FET" for dual redundancy or power share incorporating droop voltage. The standard self protection features include Overvoltage protection, Current limit/Short circuit protection, Over temperature protection and ensure safe and reliable power delivery.



PERFORMANCE SPECIFICATIONS SUMMARY AND ORDERING GUIDE ①②														
Root Model	Output							Input				Efficiency		Package ④
	V _{out} (V)	I _{out} (A)	Power (W)	R/N (mV pk-pk)		Regulation (max.) ③		V _{in} Nom. (V)	Range (V)	Power No Load (W)	Current Full Load (A)	Min.	Typ.	Case (inches)
				Typ.	Max.	Line	Load							
IRV300-12W80	12	25	300	60	120	±0.5%	±0.5%	110	16.8-160	2.5	3.0	88.5%	92%	7.27 x 4.57 x 1.56
IRV300-24W80	24	12.5	300	75	240	±0.5%	±0.5%	110	16.8-160	2.1	3.0	89.5%	92%	7.27 x 4.57 x 1.56
IRV300-54W80	54	5.5	300	51	480	±0.5%	±0.5%	110	16.8-160	4.3	3.0	89.5%	92%	7.27 x 4.57 x 1.56

- ① Please refer to the Part Number Structure when ordering.
- ② All specifications are at 110V nominal line voltage, full load, +25°C unless otherwise noted. See detailed specifications.
- ③ Regulation specifications describe output voltage deviations from a nominal/midpoint value to either extreme (50% load step).
- ④ Please see the Mechanical Specifications for details.

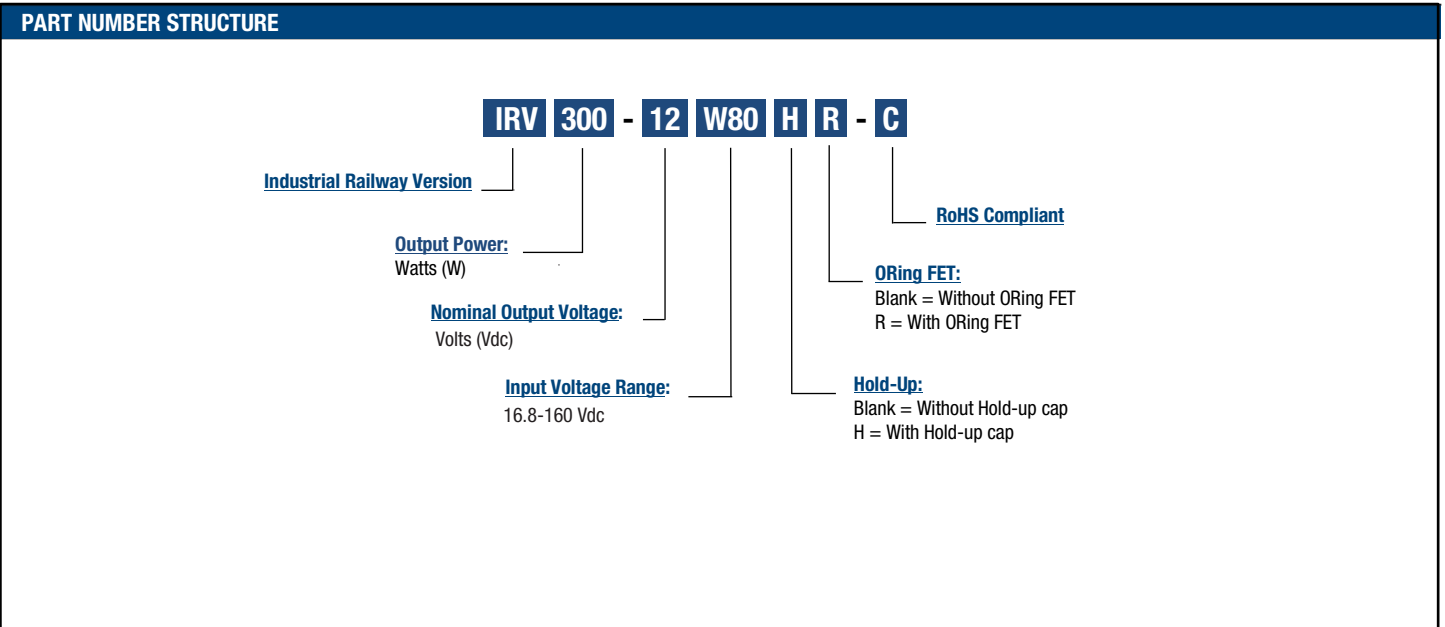

Part Number Examples:

- IRV300-12W80-C stands for Industrial Railway Version, 300W, 12Vout, 16.8-160Vin, including all standard features without options, RoHS Compliant.
- IRV300-12W80H-C stands for Industrial Railway Version, 300W, 12Vout, 16.8-160Vin, Hold-up, RoHS Compliant.
- IRV300-24W80R-C stands for Industrial Railway Version, 300W, 24Vout, 16.8-160Vin, ORing FET, RoHS Compliant.
- IRV300-54W80HR-C stands for Industrial Railway Version, 300W, 54Vout, 16.8-160Vin, Hold-up, ORing FET, RoHS Compliant.
- IRV300-MCK stands for Mating Connector Kit, (NOTE: The kit contains all 3 mating connectors. There is a Minimum Pack Quantity of 4 sets.)

FUNCTIONAL SPECIFICATIONS, IRV300-12W80-C

ABSOLUTE MAXIMUM RATINGS	Conditions [1]	Minimum	Typical/Nominal	Maximum	Units
Input Voltage, Continuous	Full temperature range	16.8		160	Vdc
Voltage Brownout and Transients	14.4V (100mS, per EN50155) / 168V (100mS)	14.4		168	Vdc
Output Power		0		303	W
Output Current	Current-limited, no damage, short-circuit protected	0		31	A
Storage Temperature Range	Vin = Zero (no power)	-55		85	°C
Absolute maximums are stress ratings. Exposure of devices to greater than any of these conditions may adversely affect long-term reliability. Proper operation under conditions other than those listed in the Performance/Functional Specifications Table is not implied or recommended.					
INPUT					
Operating Input Voltage Range		16.8	24, 36, 48, 72, 96, 110	160	Vdc
Recommended External Fuse	Fast blow		See PUL (P.17)		A
Start-up Voltage	Rising input voltage		16.5		Vdc
Undervoltage Shutdown (PUL set for 24Vin)	Falling input voltage. (14.4V for 100ms)		15.5		Vdc
Overvoltage Shutdown	Rising input voltage		170.0		Vdc
Reverse Polarity Protection [7]	With installed external fuse		Yes		Vdc
Input Current					
Full Load Conditions	Vin @ 110V nominal		3.0		A
Full Load Conditions	Vin @ 24V nominal		14.0		A
Low Line	Vin = minimum , 25A load		21		A
Inrush Transient			2.7		A
No Load Input Power	110Vin typ		2.5		W
Shut-Down Mode Input Power	nominal input voltage (110V)		1.4		W
GENERAL and SAFETY					
Efficiency	Vin=24V, full load		89		%
	Vin=110V, full load	88.5	92		%
Isolation					
Isolation Voltage, Input to Output		4250			Vdc
Isolation Voltage, Input to Case		2830			Vdc
Isolation Voltage, Case to Output		1420			Vdc
Insulation Resistance	Measured with 500Vdc		100		MΩ
Safety Rating			Reinforced		
Safety Approvals	UL 62368-1, IEC/EN62368-1, Demko		Approved		
	EN 45545, HL1 to HL3 fire/smoke		Approved		
Calculated MTBF [2]	Per Telcordia SR-332, Issue 3, Case 3, Ground Benign controlled, Tambient=40°C		1.02		Hours x 10 ⁶
DYNAMIC CHARACTERISTICS					
Fixed Switching Frequency	Stage 1/Stage 2		250/200		kHz
Power Up Startup Time	Power On to Vout regulated		350		mS
On/Off Startup Time	Remote On to Vout regulated		50		mS
Dynamic Load Response	50-75-50% load step, settling time to within ±1% of Vout		50	350	µSec
Dynamic Load Peak Deviation	Same as above,		±100	±200	mV
FEATURES and OPTIONS					
Remote On/Off Control [3]					
Positive Logic					
Positive Logic, ON state	ON=Pin open or external voltage	4		15	Vdc
Positive Logic, OFF state	OFF=Pin grounded or external voltage	0		0.7	Vdc
Control Current	Open collector/drain, sinking		1	2	mA
Programmable Undervoltage Lockout (PUL)	See Page 17 for details				

FUNCTIONAL SPECIFICATIONS, IRV300-12W80-C (CONT.)

OUTPUT	Conditions [1]	Minimum	Typical/Nominal	Maximum	Units
Total Output Power	See Derating	0	300	303	W
Voltage					
Nominal Output Voltage	No trim	11.88	12.00	12.12	Vdc
Setting Accuracy	At 50% load		1		% of Vnom.
Output Voltage Range [5]	User-adjustable	-8		+15	% of Vnom.
Overvoltage Protection [6]	Latching Mode	14.5	16	17.5	Vdc
Current					
Output Current Range	Vin=16.8V-160V	0.0	25.0		A
Short Circuit					
Over-Load Current Limit	Constant current mode	25.1	28	31	A
Short Circuit Duration (remove short for recovery)	Output shorted to ground, no damage		Continuous		
Short circuit protection method	Current limiting			31	A
Regulation [4]					
Line Regulation	Vin=16.8V to 160V, output @ nominal load			±0.5	%
Load Regulation	Iout=min. to max., Vin=110V			±0.5	%
Ripple and Noise	with a 1uF 10uF output caps		60	120	mV pk-pk
Temperature Coefficient	At all outputs		0.02		% of Vnom./°C
Maximum Capacitive Load	Constant resistance mode			0.1	F
Hold-up (Optional)	EN550155: Class S2 (@300W) / Class S3 (@200W)	10 / 20			mS
MECHANICAL					
Outline Dimensions			7.27 x 4.57 x 1.56		Inches
(Please refer to outline drawing)	L x W x H		184.6 x 116 x 39.7		mm
Cover Material			Galvanized Steel, Matte Black Powder Coat		
Chassis Material			Aluminum, Black Anodized		
Weight			32		Ounces
			900		Grams
EMI/RFI Shielding			Case		
ENVIRONMENTAL					
Operating Ambient Temperature Range	Continuous (for 10min)	-40		70 (85)	°C
Operating Case Temperature Range [9]		-40		90	°C
Thermal Protection/Shutdown [8]			See Note 8		°C
Storage Temperature	Vin = Zero (no power)	-55		85	°C
Altitude				3000	m
Electromagnetic Interference	Meets EN50121-3-2				

Performance Specification Notes

- All specifications are typical unless noted. Ambient temperature = +25°Celsius, Vin is nominal, output current is maximum rated nominal.
- Mean Time Before Failure (MTBF) is calculated using the Telcordia (Belcore) SR-332 Method 1, Case 3, Issue 3, Ground Benign, Controlled. Operating temperature = +40°C, full output load, natural air convection.
- The On/Off Control is normally driven from a switch or relay. An open collector/open drain transistor may be used in saturation and cut-off (pinch-off) modes. External logic may also be used if voltage levels are fully compliant to the specifications.
- Regulation specifications describe the deviation as the input line voltage or output load current is varied from a nominal midpoint value to either extreme (50% load).
- Do not exceed maximum power ratings or output overvoltage when adjusting output trim values.
- Output over-voltage protection (OVP) is latching mode. Recycle input to enable, after the output over-voltage condition has been removed.
- If reverse polarity is accidentally applied to the input, to ensure reverse input protection, always connect an external fast blow input fuse in series with the +Vin input.
- The output will shutdown when the temperature sensors on the main PCB is over 127°C and will recover after the temperature drops to 115°C.
- The maximum temperature at any of the two baseplate monitor points (refer to Page 19) must not exceed 90°C under all operating conditions.

TYPICAL PERFORMANCE DATA, IRV300-12W80-C

Start-up Waveform

Vin = 110V, 0A Load

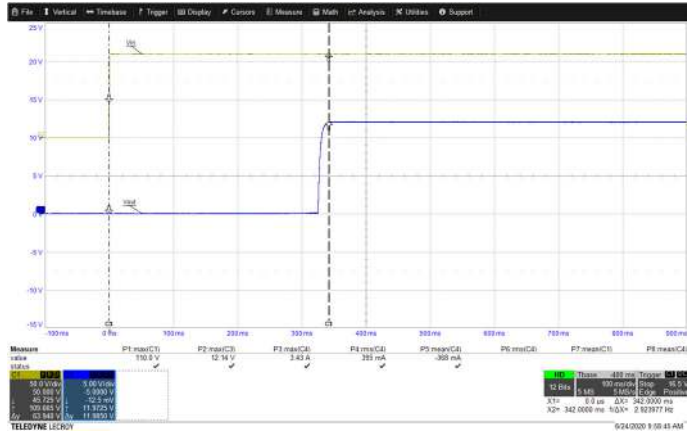

Start-up Waveform

Vin = 110V, 25A Load

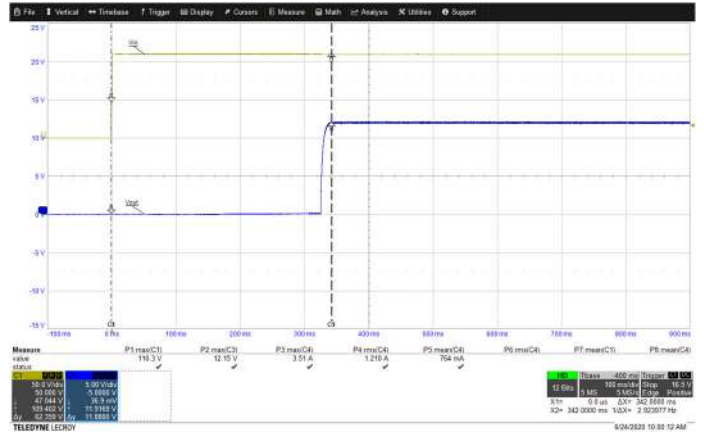

Hold Up/Interruption Time: Measured hold up time with 12Vo/200W

Ch1: Vin Ch3: Vout Ch4: Iout (NOTE: for models with Hold Up option)

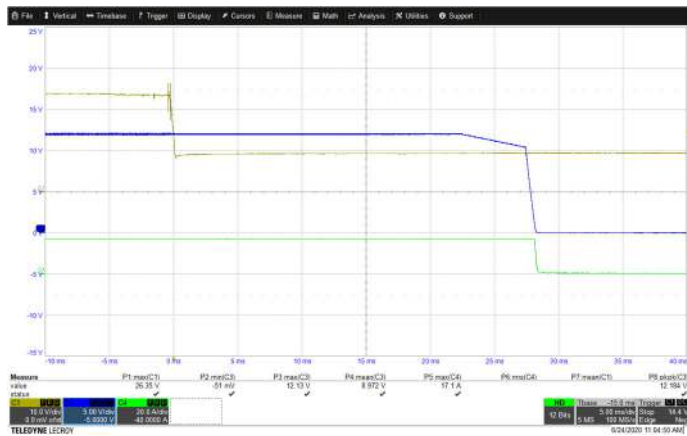

Hold Up/Interruption Time: Measured hold up time with 12Vo/300W

Ch1: Vin Ch3: Vout Ch4: Iout (NOTE: for models with Hold Up option)

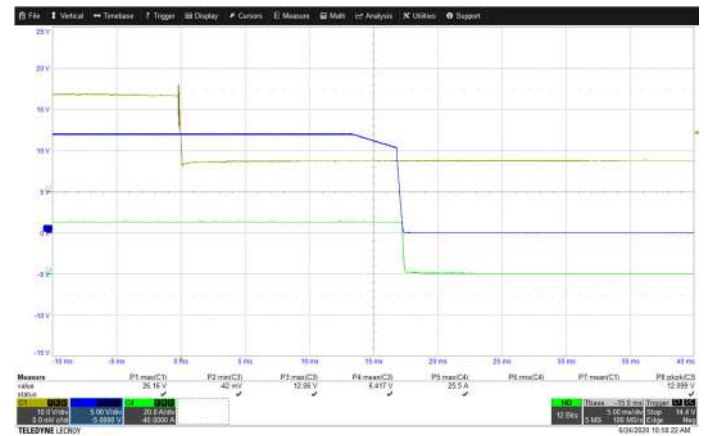

Power Efficiency vs Load

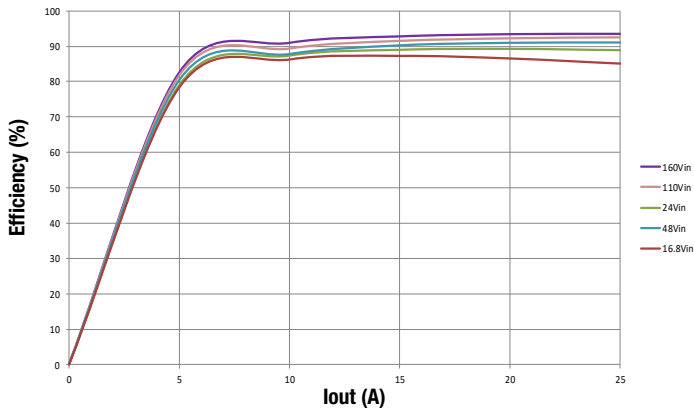

Overload Protection at Vin = 110V @ 22°C

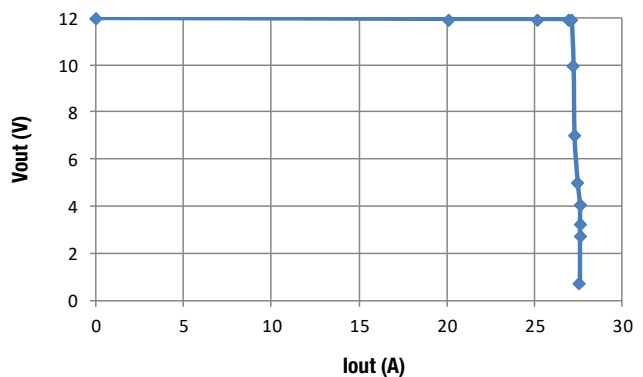

TYPICAL PERFORMANCE DATA, IRV300-12W80-C

Output Ripple & Noise (58mVp-p)

Vin = 110V (Ch1), Vout = 12V (Ch3), Iout = 25A (Ch4), 5us/div.

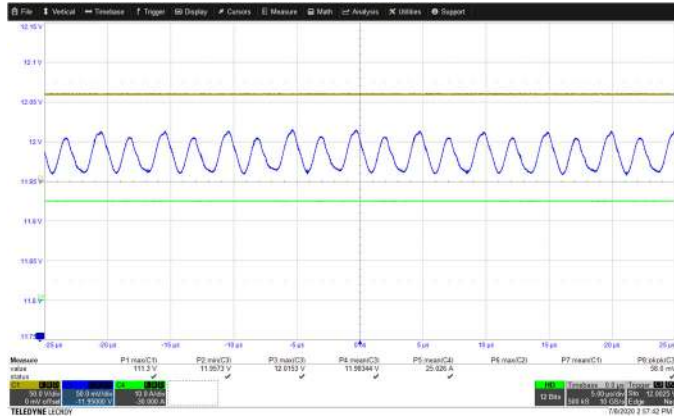

Transient Response

Vin = 110V (Ch1), Vout (Ch3), Iout (Ch4) Step Load 75% → 50%, 20us/div. Vpp=103mV

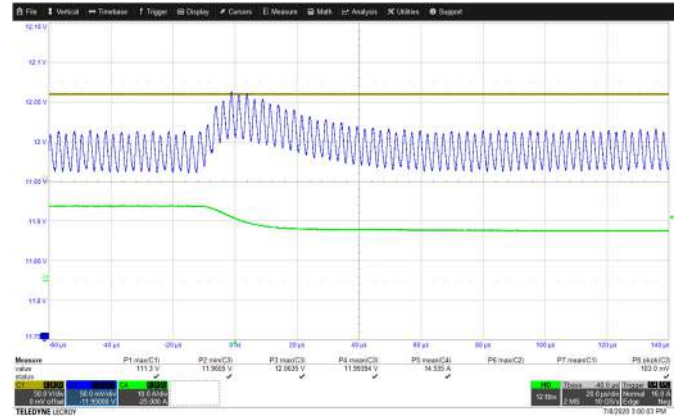

Transient Response

Vin = 110V (Ch1), Vout (Ch3), Iout (Ch4) Step Load 50% → 75%, 20us/div. Vpp=96mV

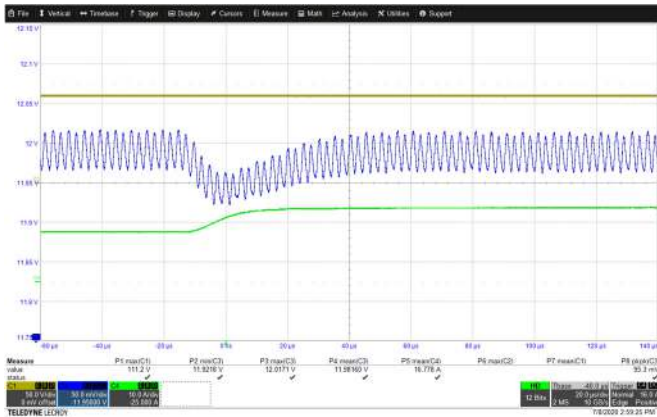

IRV300-12W80-C, Temperature Derating

Vin = 16.8-160V (Still Air) Ambient Temperature

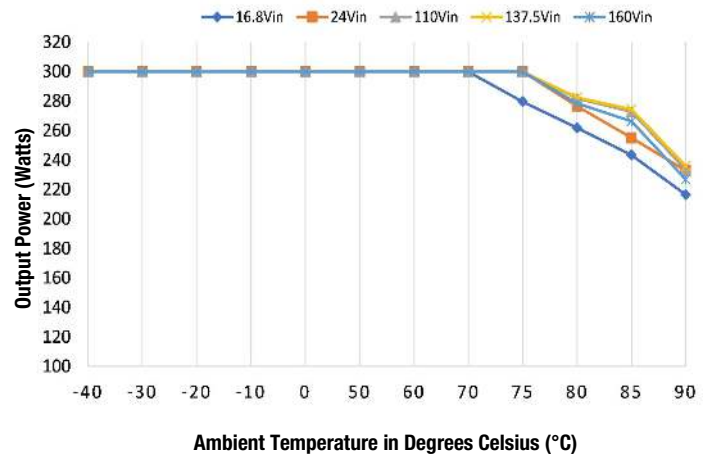

FUNCTIONAL SPECIFICATIONS, IRV300-24W80-C

ABSOLUTE MAXIMUM RATINGS	Conditions [1]	Minimum	Typical/Nominal	Maximum	Units
Input Voltage, Continuous	Full temperature range	16.8		160	Vdc
Input Voltage, Transient	14.4V (100mS, per EN50155) / 168V (100mS)	14.4		168	Vdc
Output Power		0		303	W
Output Current	Current-limited, no damage, short-circuit protected	0		16.5	A
Storage Temperature Range	Vin = Zero (no power)	-55		85	°C
Absolute maximums are stress ratings. Exposure of devices to greater than any of these conditions may adversely affect long-term reliability. Proper operation under conditions other than those listed in the Performance/Functional Specifications Table is not implied or recommended.					
INPUT					
Operating Input Voltage Range		16.8	24, 36, 48, 72, 96, 110	160	Vdc
Recommended External Fuse	Fast blow		See PUL (P.17)		A
Start-up Voltage	Rising input voltage		16.5		Vdc
Undervoltage Shutdown (PUL set for 24Vin)	Falling input voltage. (14.4V for 100ms)		15.5		Vdc
Overvoltage Shutdown	Rising input voltage		170.0		Vdc
Reverse Polarity Protection [7]	With installed external fuse		Yes		Vdc
Input Current					
Full Load Conditions	Vin @ 110V nominal		3.0		A
Full Load Conditions	Vin @ 24V nominal		14.1		A
Low Line	Vin = minimum , 12.5A load		20.6		A
Inrush Transient			2.7		A
No Load Input Power	110Vin typ.		2.1		W
Shut-Down Mode Input Power	110Vin typ.		1.4		W
GENERAL and SAFETY					
Efficiency	Vin=24V, full load		88.1		%
	Vin=110V, full load	89.5	92		%
Isolation					
Isolation Voltage, Input to Output		4250			Vdc
Isolation Voltage, Input to Case		2830			Vdc
Isolation Voltage, Case to Output		1420			Vdc
Insulation Resistance	Measured with 500Vdc		100		MΩ
Safety Rating			Reinforced		
Safety Approvals	UL 62368-1, IEC/EN62368-1, Demko		Approved		
	EN 45545, HL1 to HL3 fire/smoke		Approved		
Calculated MTBF [2]	Per Telcordia SR-332, Issue 3, Case 3, Ground Benign controlled, Tambient=40°C		1.03		Hours x 10 ⁶
DYNAMIC CHARACTERISTICS					
Fixed Switching Frequency	Stage 1/Stage 2		250/200		kHz
Power Up Startup Time	Power On to Vout regulated		350		mS
On/Off Startup Time	Remote ON to Vout regulated		50		mS
Dynamic Load Response	50-75-50% load step, settling time to within ±1% of Vout		150	350	µSec
Dynamic Load Peak Deviation	Same as above,		±100	±200	mV
FEATURES and OPTIONS					
Remote On/Off Control [3]					
Positive Logic					
Positive Logic, ON state	ON=Pin open or external voltage	4		15	Vdc
Positive Logic, OFF state	OFF=Pin grounded or external voltage	0		0.7	Vdc
Control Current	Open collector/drain, sinking		1	2	mA
Programmable Undervoltage Lockout (PUL)	See Page 17 for details				

FUNCTIONAL SPECIFICATIONS, IRV300-24W80-C (CONT.)

OUTPUT	Conditions [1]	Minimum	Typical/Nominal	Maximum	Units
Total Output Power	See Derating	0	300	303	W
Voltage					
Nominal Output Voltage	No trim	23.76	24	24.24	Vdc
Setting Accuracy	At 50% load		±1		% of Vnom.
Output Voltage Range [5]	User-adjustable	-10		+10	% of Vnom.
Overvoltage Protection [6]	Latching Mode	28	30	33	Vdc
Current					
Output Current Range	Vin=16.8V-160V	0	12.5		A
Short Circuit					
Over-Load Current Limit	Constant current mode	12.6	14.4	16.5	A
Short Circuit Duration (remove short for recovery)	Output shorted to ground, no damage		Continuous		
Short circuit protection method	Current limiting			16.5	A
Regulation [4]					
Line Regulation	Vin=min. to max., Vout=nom., full load			±0.5	%
Load Regulation	Iout=min. to max., Vin=110V			±0.5	%
Ripple and Noise	with a 1uF 10uF output caps		75	240	mV pk-pk
Temperature Coefficient	At all outputs		±0.02		% of Vnom./°C
Maximum Capacitive Load	Constant resistance mode			0.1	F
Hold-up (Optional)	EN550155: Class S2 (@300W) / Class S3 (@200W)	10 / 20			mS
MECHANICAL					
Outline Dimensions			7.27 x 4.57 x 1.56		Inches
(Please refer to outline drawing)	L x W x H		184.6 x 116 x 39.7		mm
Cover Material			Galvanized Steel, Matte Black Powder Coat		
Chassis Material			Aluminum, Black Anodized		
Weight			32		Ounces
			900		Grams
EMI/RFI Shielding			Case		
ENVIRONMENTAL					
Operating Ambient Temperature Range	Continuous (for 10min)	-40		70 (85)	°C
Operating Case Temperature Range [9]		-40		90	°C
Thermal Protection/Shutdown [8]	Temperature on PCB		See Note 8		°C
Storage Temperature	Vin = Zero (no power)	-55		85	°C
Altitude				3000	m
Electromagnetic Interference	Meets EN50121-3-2				

Performance Specification Notes

- All specifications are typical unless noted. Ambient temperature = +25°Celsius, Vin is nominal, output current is maximum rated nominal.
- Mean Time Before Failure (MTBF) is calculated using the Telcordia (Belcore) SR-332 Method 1, Case 3, Issue 3, Ground Benign, Controlled. Operating temperature = +40°C, full output load, natural air convection.
- The On/Off Control is normally driven from a switch or relay. An open collector/open drain transistor may be used in saturation and cut-off (pinch-off) modes. External logic may also be used if voltage levels are fully compliant to the specifications.
- Regulation specifications describe the deviation as the input line voltage or output load current is varied from a nominal midpoint value to either extreme (50% load).
- Do not exceed maximum power ratings or output overvoltage when adjusting output trim values.
- Output over-voltage protection (OVP) is latching mode. Recycle input to enable, after the output over-voltage condition has been removed.
- If reverse polarity is accidentally applied to the input, to ensure reverse input protection, always connect an external fast blow input fuse in series with the +Vin input.
- The output will shutdown when the temperature sensors on the main PCB is over 127°C and will recover after the temperature drops to 115°C.
- The maximum temperature at any of the two baseplate monitor points (refer to Page 19) must not exceed 90°C under all operating conditions.

TYPICAL PERFORMANCE DATA, IRV300-24W80-C

Start-up Waveform
Vin = 110V, 0A Load

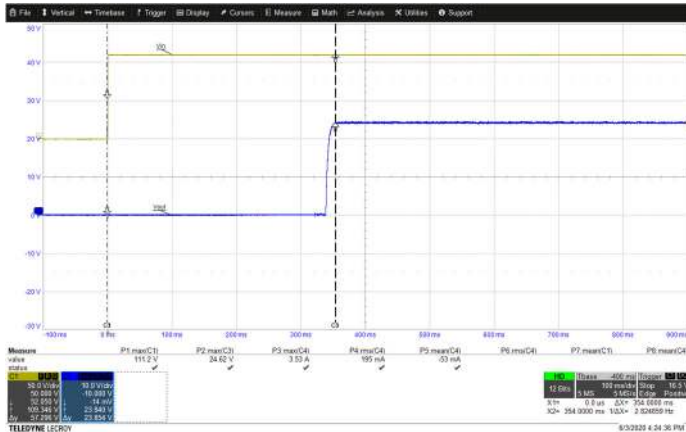

Start-up Waveform
Vin = 110V, 12.5A Load

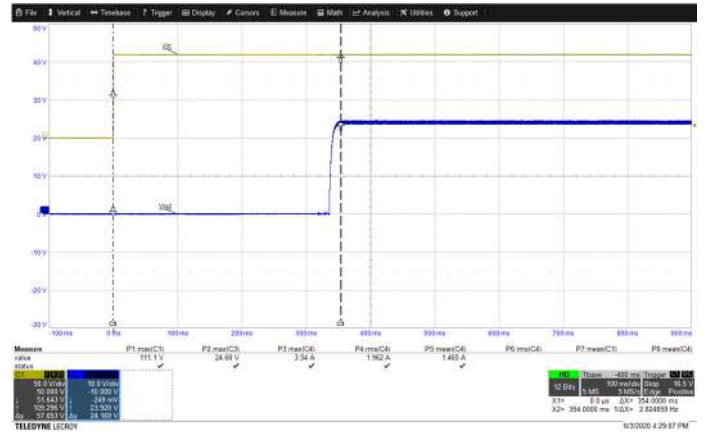

Hold Up/Interruption Time: Measured hold up time with 24Vo/200W
Ch1: Vin Ch3: Vout Ch4: Iout (NOTE: for models with Hold Up option)



Hold Up/Interruption Time: Measured hold up time with 24Vo/300W
Ch1: Vin Ch3: Vout Ch4: Iout (NOTE: for models with Hold Up option)



Power Efficiency vs Load

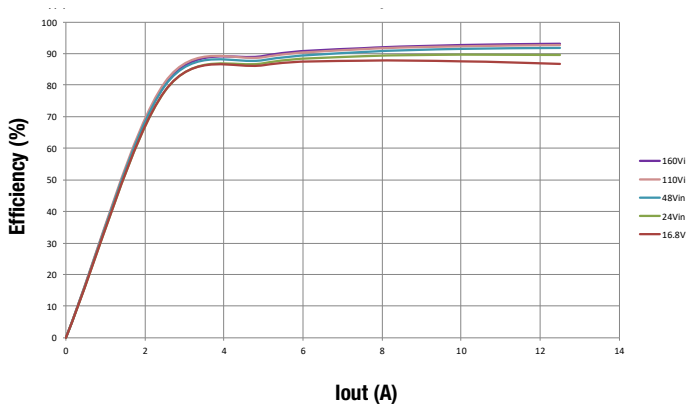

Overload Protection at Vin = 110V @ 22°C

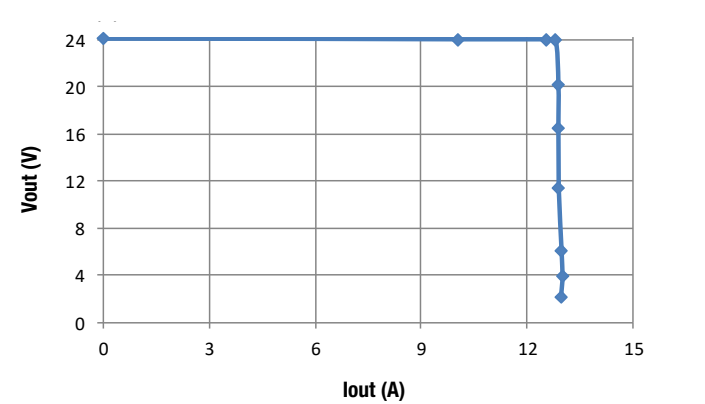

TYPICAL PERFORMANCE DATA, IRV300-24W80-C

Output Ripple & Noise (62mVp-p)

Vin = 110V (Ch1), Vout = 24V (Ch3), Iout = 12.5A (Ch4), 5us/div.

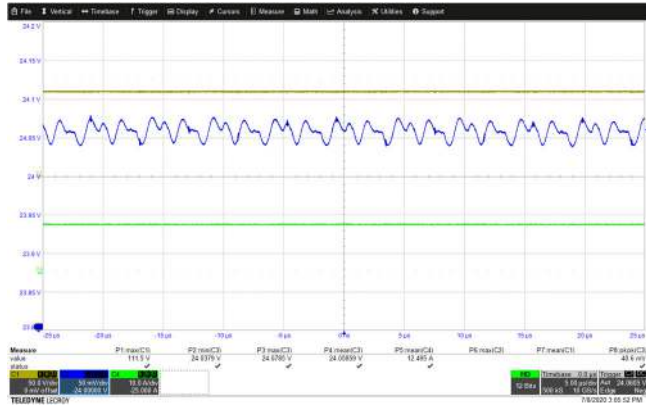

Transient Response

Vin = 110V (Ch1), Vout (Ch3), Iout (Ch4) Step Load 75% → 50%, 50us/div. Vpp=111mV

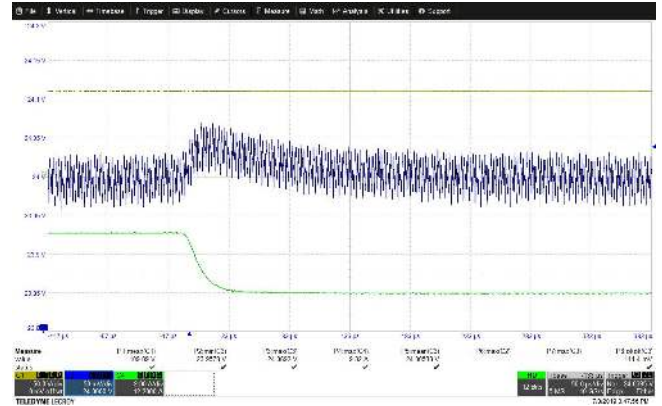

Transient Response

Vin = 110V (Ch1), Vout (Ch3), Iout (Ch4) Step Load 50% → 75%, 50us/div. Vpp=112mV

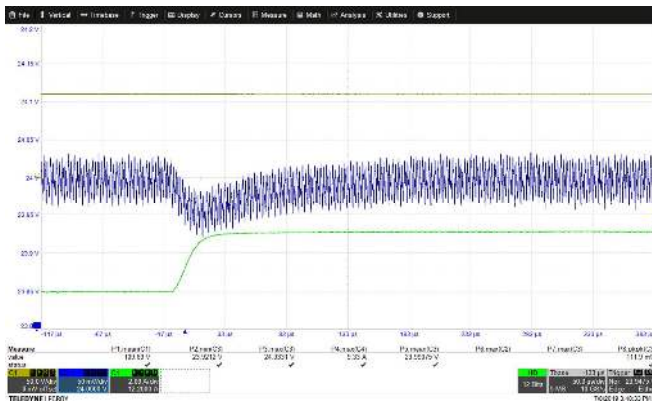

IRV300-24W80-C, Temperature Derating

Vin = 16.8-160V (Still Air) Ambient Temperature

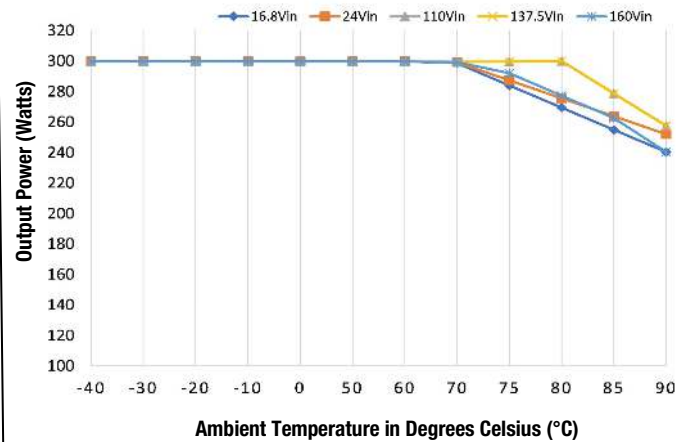

FUNCTIONAL SPECIFICATIONS, IRV300-54W80-C

ABSOLUTE MAXIMUM RATINGS	Conditions [1]	Minimum	Typical/Nominal	Maximum	Units
Input Voltage, Continuous	Full temperature range	16.8		160	Vdc
Input Voltage, Transient	14.4V (100mS, per EN50155) / 168V (100mS)	14.4		168	Vdc
Output Power		0		305	W
Output Current	Current-limited, no damage, short-circuit protected	0		6.4	A
Storage Temperature Range	Vin = Zero (no power)	-55		85	°C
Absolute maximums are stress ratings. Exposure of devices to greater than any of these conditions may adversely affect long-term reliability. Proper operation under conditions other than those listed in the Performance/Functional Specifications Table is not implied or recommended.					
INPUT					
Operating Input Voltage Range		16.8	24, 36, 48, 72, 96, 110	160	Vdc
Recommended External Fuse	Fast blow		See PUL (P.17)		A
Start-up Voltage	Rising input voltage		16.5		Vdc
Undervoltage Shutdown (PUL set for 24Vin)	Falling input voltage. (14.4V for 100ms)		15.5		Vdc
Oversvoltage Shutdown	Rising input voltage		170		Vdc
Reverse Polarity Protection [7]	With installed external fuse		Yes		Vdc
Input Current					
Full Load Conditions	Vin @ 110V nominal		3.0		A
Full Load Conditions	Vin @ 24V nominal		14.2		A
Low Line	Vin = minimum , 5.55A load		21.0		A
Inrush Transient			2.7		A
No Load Input Power	110Vin typ.		4.3		W
Shut-Down Mode Input Power	110Vin typ.		2.9		W
GENERAL and SAFETY					
Efficiency	Vin=24V, full load		88		%
	Vin=110V, full load	89.5	92		%
Isolation					
Isolation Voltage, Input to Output		4250			Vdc
Isolation Voltage, Input to Case		2830			Vdc
Isolation Voltage, Case to Output		2250			Vdc
Insulation Resistance	Measured with 500Vdc		100		MΩ
Safety Rating			Reinforced		
Safety Approvals	UL 62368-1, IEC/EN62368-1, Demko		Approved		
	EN 45545, HL1 to HL3 fire/smoke		Approved		
Calculated MTBF [2]	Per Telcordia SR-332, Issue 3, Case 3, Ground Benign controlled, Tambient=40°C		1.6		Hours x 10 ⁶
DYNAMIC CHARACTERISTICS					
Fixed Switching Frequency	Stage 1/Stage 2		250/200		kHz
Power Up Startup Time	Power On to Vout regulated		370		mS
On/Off Startup Time	Remote On to Vout regulated		50		mS
Dynamic Load Response	50-75-50% load step, settling time to within ±1% of Vout		300	500	µSec
Dynamic Load Peak Deviation	Same as above,		±165	±500	mV
FEATURES and OPTIONS					
Remote On/Off Control [3]					
Positive Logic					
Positive Logic, ON state	ON=Pin open or external voltage	4		15	Vdc
Positive Logic, OFF state	OFF=Pin grounded or external voltage	0		0.7	Vdc
Control Current	Open collector/drain, sinking		1	2	mA
Programmable Undervoltage Lockout (PUL)	See Page 17 for details				

FUNCTIONAL SPECIFICATIONS, IRV300-54W80-C (CONT.)

OUTPUT	Conditions [1]	Minimum	Typical/Nominal	Maximum	Units
Total Output Power	See Derating	0	302	305	W
Voltage					
Nominal Output Voltage	No trim	53.46	54	54.54	Vdc
Setting Accuracy	At 50% load		±1		% of Vnom.
Output Voltage Range [5]	User-adjustable	47		57	Vdc
Overvoltage Protection [6]	Latching Mode	60	62.5	65	Vdc
Current					
Output Current Range	Vin=16.8V-160V	0	5.5		A
Short Circuit					
Over-Load Current Limit	Constant current mode	5.65	6.05	6.45	A
Short Circuit Duration (remove short for recovery)	Output shorted to ground, no damage		Continuous		
Short circuit protection method	Current limiting			7	A
Regulation [4]					
Line Regulation	Vin=min. to max., Vout=nom., full load			±0.5	%
Load Regulation	Iout=min. to max., Vin=110V			±0.5	%
Ripple and Noise	with a 1uF 10uF output caps		51	480	mV pk-pk
Temperature Coefficient			±0.02		% of Vnom./°C
Maximum Capacitive Load	Constant resistance mode			0.1	F
Hold-up (Optional)	EN550155: Class S2 (@300W) / Class 3 (@180W)	10 / 20			mS
MECHANICAL					
Outline Dimensions			7.27 x 4.57 x 1.56		Inches
(Please refer to outline drawing)	L x W x H		184.6 x 116 x 39.7		mm
Cover Material			Galvanized Steel, Matte Black Powder Coat		
Chassis Material			Aluminum, Black Anodized		
Weight			32		Ounces
			900		Grams
EMI/RFI Shielding			Case		
ENVIRONMENTAL					
Operating Ambient Temperature Range	Continuous (for 10min.)	-40		70 (85)	°C
Operating Case Temperature Range [9]		-40		90	°C
Thermal Protection/Shutdown [8]			See Note 8		°C
Storage Temperature	Vin = Zero (no power)	-55		85	°C
Altitude				3000	m
Electromagnetic Interference	Meets EN50121-3-2				

Performance Specification Notes

- All specifications are typical unless noted. Ambient temperature = +25°Celsius, Vin is nominal, output current is maximum rated nominal.
- Mean Time Before Failure (MTBF) is calculated using the Telcordia (Belcore) SR-332 Method 1, Case 3, Issue 3, Ground Benign, Controlled. Operating temperature = +40°C, full output load, natural air convection.
- The On/Off Control is normally driven from a switch or relay. An open collector/open drain transistor may be used in saturation and cut-off (pinch-off) modes. External logic may also be used if voltage levels are fully compliant to the specifications.
- Regulation specifications describe the deviation as the input line voltage or output load current is varied from a nominal midpoint value to either extreme (50% load).
- Do not exceed maximum power ratings or output overvoltage when adjusting output trim values.
- Output over-voltage protection (OVP) is latching mode. Recycle input to enable, after the output over-voltage condition has been removed.
- If reverse polarity is accidentally applied to the input, to ensure reverse input protection, always connect an external fast blow input fuse in series with the +Vin input.
- The output will shutdown when the temperature sensors on the main PCB is over 127°C and will recover after the temperature drops to 115°C.
- The maximum temperature at any of the two baseplate monitor points (refer to Page 19) must not exceed 90°C under all operating conditions.

TYPICAL PERFORMANCE DATA, IRV300-54W80-C

Start-up Waveform
Vin = 110V, 0A Load

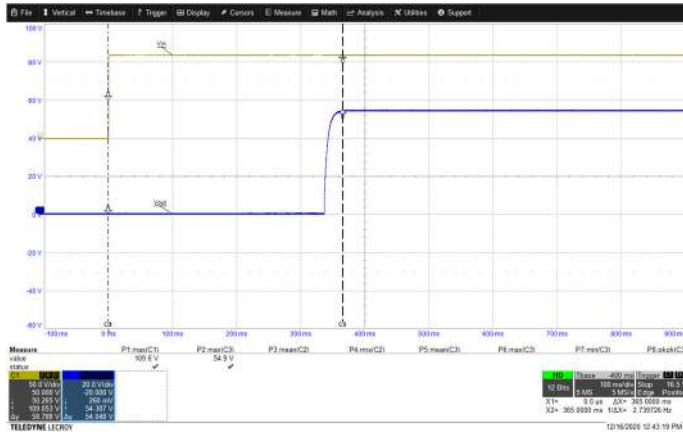

Start-up Waveform
Vin = 110V, 5.6A Load

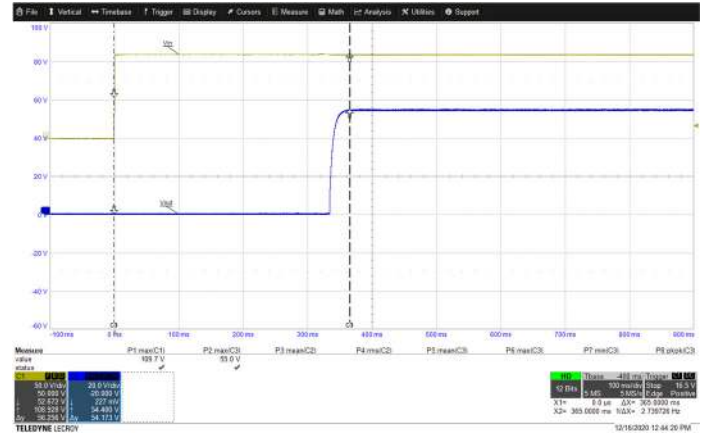

Hold Up/Interruption Time: Measured hold up time with 54Vo/180W
Ch1: Vin Ch3: Vout Ch4: Iout (NOTE: for models with Hold Up option)

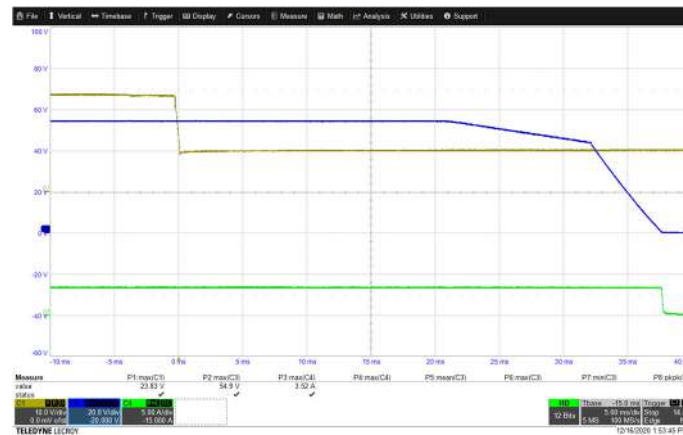

Hold Up/Interruption Time: Measured hold up time with 54Vo/300W
Ch1: Vin Ch3: Vout Ch4: Iout (NOTE: for models with Hold Up option)



Efficiency vs Line and Load

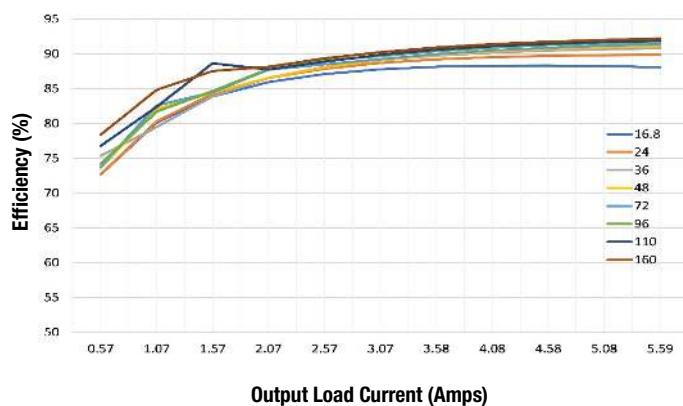

Overload Protection at Vin = 110V @ 22°C

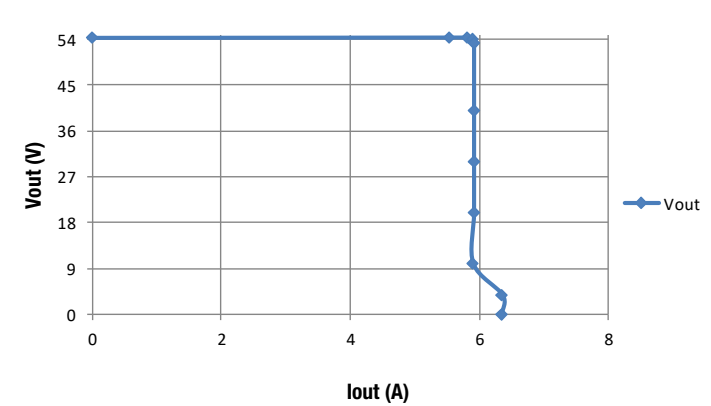

TYPICAL PERFORMANCE DATA, IRV300-54W80-C

Output Ripple & Noise (51mVp-p)

Vin = 110V (Ch1), Vout = 54V (Ch3), Iout = 5.6A (Ch4), 5us/div.

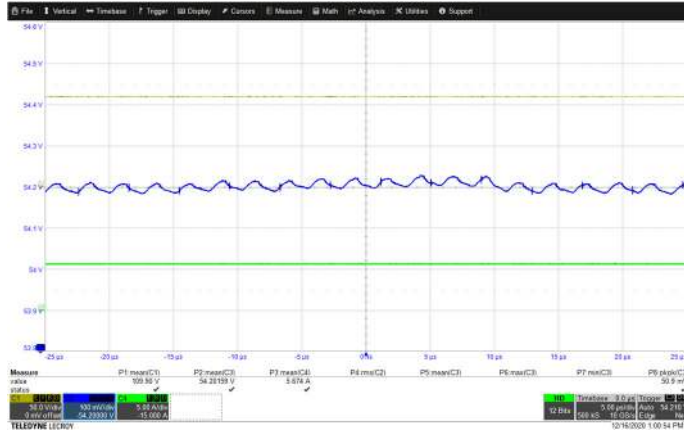

Transient Response

Vin = 110V (Ch1), Vout (Ch3), Iout (Ch4) Step Load 75% → 50%, 50us/div. Vpp=147mV

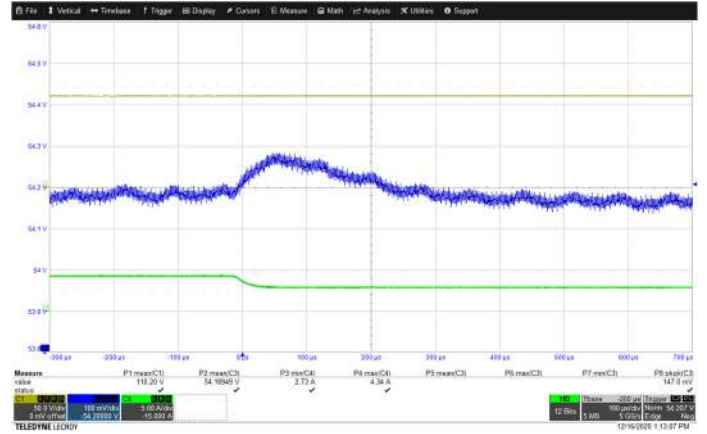

Transient Response

Vin = 110V (Ch1), Vout (Ch3), Iout (Ch4) Step Load 50% → 75%, 50us/div. Vpp=150mV

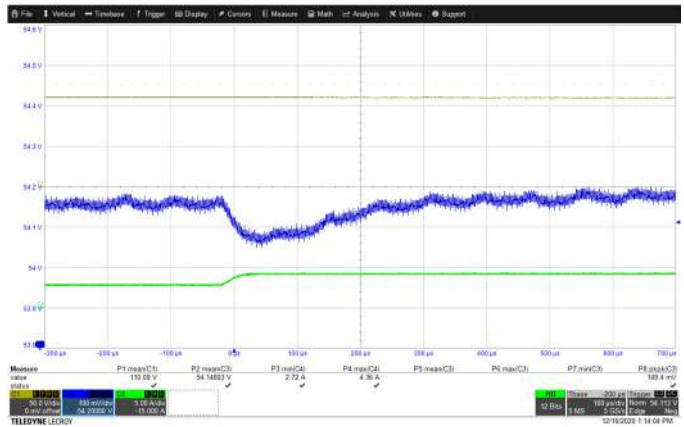

IRV300-54W80-C, Temperature Derating

Vin = 16.8-160V (Still Air) Ambient Temperature

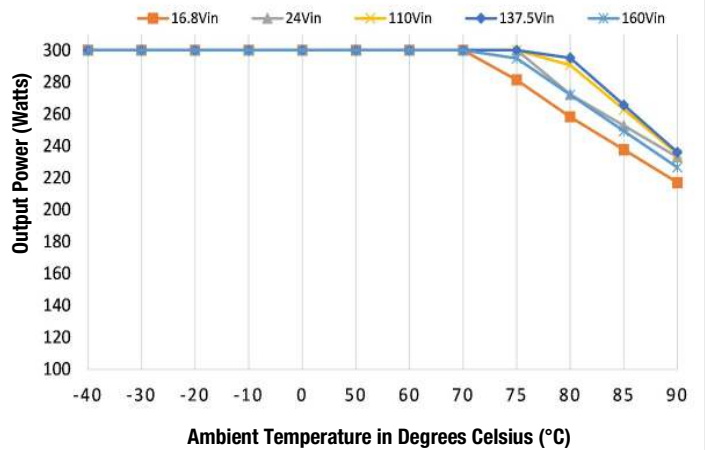

ENVIRONMENTAL QUALIFICATION TESTING:

Standard	Test Description	Result
EN 50155:2017	Performance Test – DC Supplied Equipment	Compliant
EN 50155:2017	Supply Overvoltages	Compliant
EN 61000-4-5:2014	Surge Immunity	Compliant
EN 61000-4-2:2008	Electrostatic Discharge Immunity	Compliant
EN 61000-4-4:2012	Electrical Fast Transient/Burst Immunity	Compliant
EN 61000-4-3:2010	Radiated RF Immunity	Compliant
EN 61000-4-6:2013	Conducted RF Immunity	Compliant
EN 55011:2016 A11:2020	Radiated Emissions	Compliant
EN 55011	Conducted Emissions	Compliant
EN 50155:2017	Insulation	Compliant
EN 50155, IEC 60068-2-2 and IEC 60068-2-30	Temperature	Compliant
EN 50155:2017	Salt Mist	Compliant

Electromagnetic Immunity:

Standard	Test	Description	Level	Criteria	Result
IEC/EN61000-4-2	ESD	±6kV Contact ± 8kV Air	3	A	Pass
IEC/EN61000-4-3	RF Immunity	80MHz-1GHz @ 20V/m; 1.4GHz-2GHz @ 10V/m; 2GHz-2.7GHz @ 5V/m; 5.1GHz- 6GHz @ 3V/m	3	A	Pass
IEC/EN61000-4-4	EFT	±2kV	3	A	Pass
IEC/EN61000-4-5	Surge	±2kV L-E ±1kV L-L 12Ω impedance	3	A	Pass
IEC/EN61000-4-6	Conducted RF Immunity	150kHz – 80MHz @ 10V RMS	3	A	Pass

EN 50155:2017 STANDARD			
Nominal Input	Permanent Input Range (0.7 - 1.25 Vin)	Brownout 100ms (0.6 x Vin)	Transient 1s (1.4 x Vin)
24V	16.8V – 30V	14.4V	33.6V
28V	19.6V – 35V	16.8V	39.2V
36V	25.2V – 45V	21.6V	50.4V
48V	33.6V – 60V	28.8V	67.2V
72V	50.4V – 90V	43.2V	100.8V
96V	67.2V – 120V	57.6V	134.4V
110V	77V – 137.5V	66V	154V

TECHNICAL NOTES

Output Voltage Adjustment

The output voltage can be adjusted higher (trimming-up) or lower (trimming-down) than the nominal voltage by connecting an external resistor across VO_UP and VO_ADJ or VO_DOWN and VO_ADJ at the control connector. Short-circuit VO_UP and VO_ADJ will set output voltage to maximum. Short-circuit VO_DOWN and VO_ADJ will set output voltage to minimum.

<p>To adjust output voltage Vo higher than nominal voltage for IRV300-12W80-C: External resistor R_UP for trimming-up $R_{UP} = 0.4645(13.8-V_o)/(V_o-12)$ (kΩ)</p>
<p>To adjust output voltage Vo lower than nominal voltage for IRV300-12W80-C: External resistor R_DOWN for trimming-down $R_{DOWN} = 1.3(V_o-11)/(12-V_o)$ (kΩ)</p>
<p>To adjust output voltage Vo higher than nominal voltage for IRV300-24W80-C: External resistor R_UP for trimming-up $R_{UP} = 0.2753(26.4-V_o)/(V_o-24)$ (kΩ)</p>
<p>To adjust output voltage Vo lower than nominal voltage for IRV300-24W80-C: External resistor R_DOWN for trimming-down $R_{DOWN} = 2.61(V_o-21.6)/(24-V_o)$ (kΩ)</p>
<p>To adjust output voltage Vo higher than nominal voltage for IRV300-54W80-C: External resistor R_UP for trimming-up $R_{UP}=6.438(57-V_o)/(V_o-54)$ (kΩ)</p>
<p>To adjust output voltage Vo lower than nominal voltage fvor IRV300-54W80-C: External resistor R_DOWN for trimming-down $R_{DOWN}=4.977(V_o-47)/(54-V_o)$ (kΩ)</p>

Model	Trim Down	Trim Up
IRV300-12W80-C	Vout=11.0V	Vout=13.2V
	R_DOWN=0Ω	R_UP= 0.232kΩ
IRV300-24W80-C	Vout=21.6V	Vout=26.4V
	R_DOWN=0Ω	R_UP=0Ω
IRV300-54W80-C	Vout=48.0V	Vout=57.0V
	R_DOWN=0.83kΩ	R_UP=0Ω

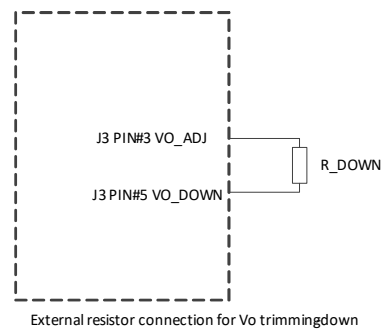
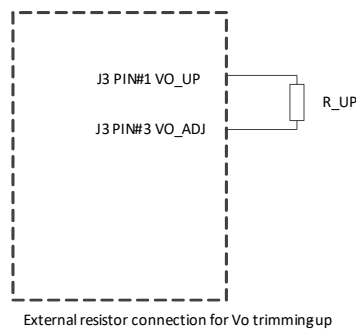

External resistor connection diagram for output voltage adjustment

Hold Up Option

Hold Up feature ensures the output uninterrupted for no less than 10mS at full load when the input voltage drops lower than 14.4V. When input voltage drops to lower than VIN_OFF (refer to PUL section) but is higher than 14.4V, a 100mS timer is set. If the input voltage doesn't recover to above VIN_ON in 100mS, the timer will be reset, the converter will shut down. If the input voltage drops lower than 14.4V, Hold Up circuit starts to work to keep the output uninterrupted. The converter will shut down if the output voltage starts to drop and cause the open-collector P_OK+ signal to be released (to open status) or the timer is reset.

PUL Specification and Recommended External Fuse

IRV300 Series PUL table and formula for PUL resistor selection and calculation of battery under voltage protection setup.

Battery	R_PUL	VIN_ON	VIN_OFF	External Fuse
24V	Not connected	16.4V	15.5V	25A fast, Littelfuse 0314025
36V	267kΩ	19.9V	17.9V	20A fast, Littelfuse 0314020
48V	82.5kΩ	28.7V	26.3V	15A fast, Littelfuse 0314015
72V	48.7kΩ	37.5V	33.6V	12A fast Littelfuse 0314012
96V	22kΩ	63.6V	57.5V	8A fast Schurter 8020.5077.G
110V	18.7kΩ	72.4V	65.3V	8A fast Schurter 8020.5077.G

Input under voltage turn off could be setup by selecting PUL resistor given in the table above. The resistor value could also be calculated based on the preferred turn-off voltage that customers select for battery protection.

$$R_PUL = 953.62 / (VIN_OFF - 14.4)$$

Where R_PUL is PUL resistor in kΩ, VIN_OFF is the turn-off voltage in Volt. Corresponding turn-on voltage VIN_ON is

$$VIN_ON = 15.95(R_PUL + 66.23) / R_PUL$$

When input voltage drops lower than VIN_OFF, the converter will continue operating 100mS before turning off the output. When input voltage drops lower than 14.4V, the converter enters input interruption mode. The hold-up circuit will keep the output uninterrupted for no less than 10mS under nominal load output. The converter will be shut down if input voltage is not recovered to above 16V afterward.

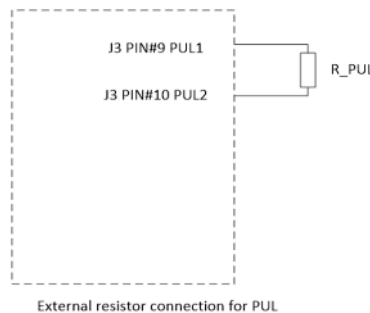

P_OK+ Signal

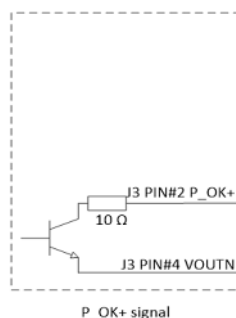

ORing FET Option

ORing FET feature allows outputs of multiple units to be connected in parallel when high output power is required or when N+1 redundancy operation is required.

The units in parallel have passive current sharing. To put units in parallel operation, load line has to be enabled on each unit by connecting the LL_EN pin to VOUTN pin on the control connector. The output voltage will drop with the increase of output current by 20mV/A for IRV300-12W80R-C, 40mV/A for IRV300-24W80R-C and 100mV/A for IRV300-54W80R-C.

The output power cables should have the same gauge and length for each unit from the output connector to the meeting points to the load to ensure balanced power output for each unit.

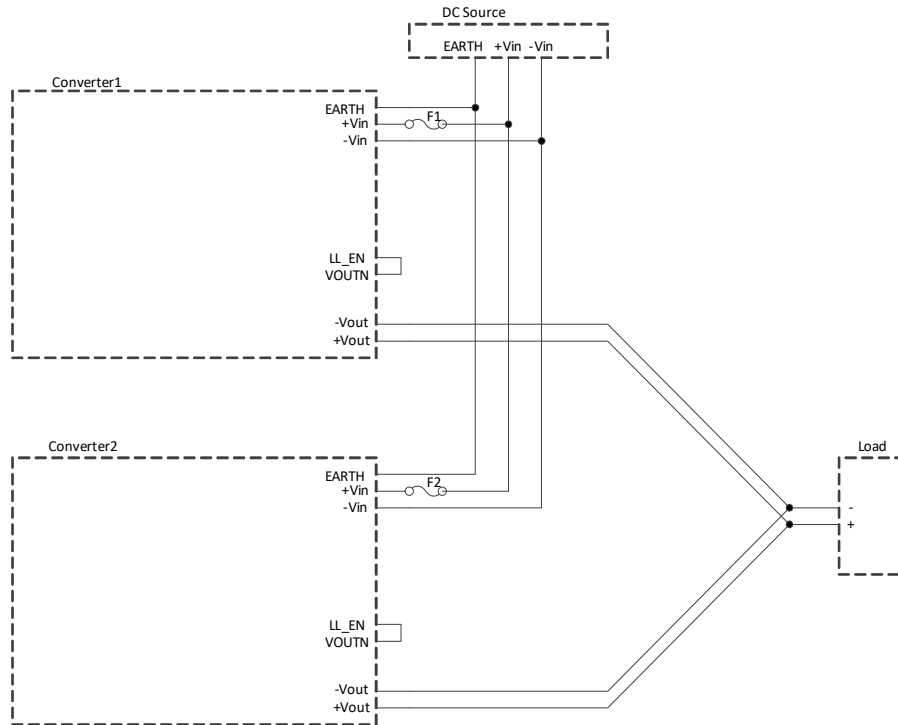

ORing Feature - Parallel Connection Diagram

Conducted Emission Test, (110Vin, 12V @ 24A out)

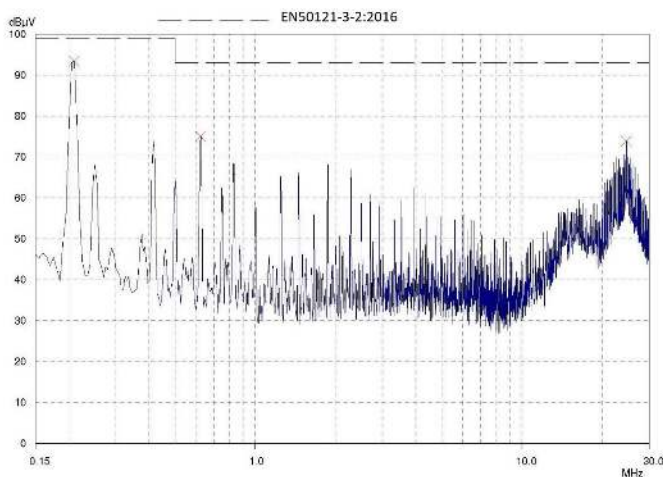

Radiated Emission Test, (110Vin, 12V @ 24A out)

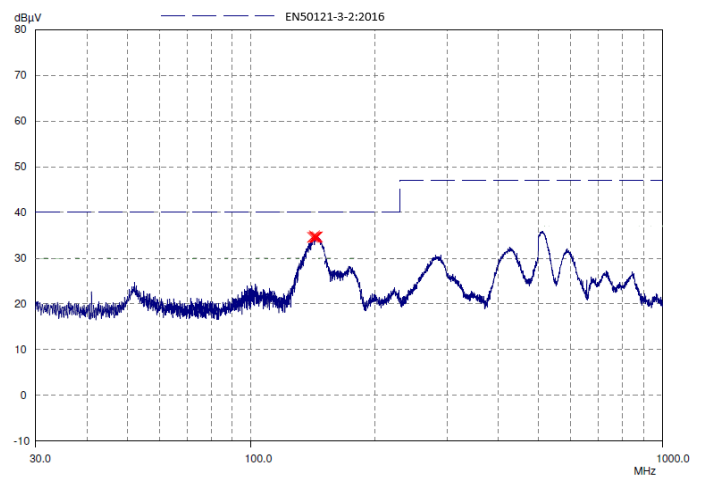

MECHANICAL SPECIFICATIONS

UNLESS OTHERWISE SPECIFIED:
DIMENSIONS ARE IN INCHES
[mm SHOWN FOR REF ONLY]
TOLERANCES:
2 PL ±0.02 3 PL ±0.010
ANGLES ±1.0°

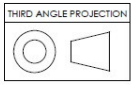

THIRD ANGLE PROJECTION

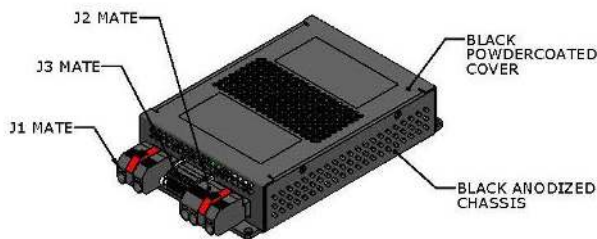
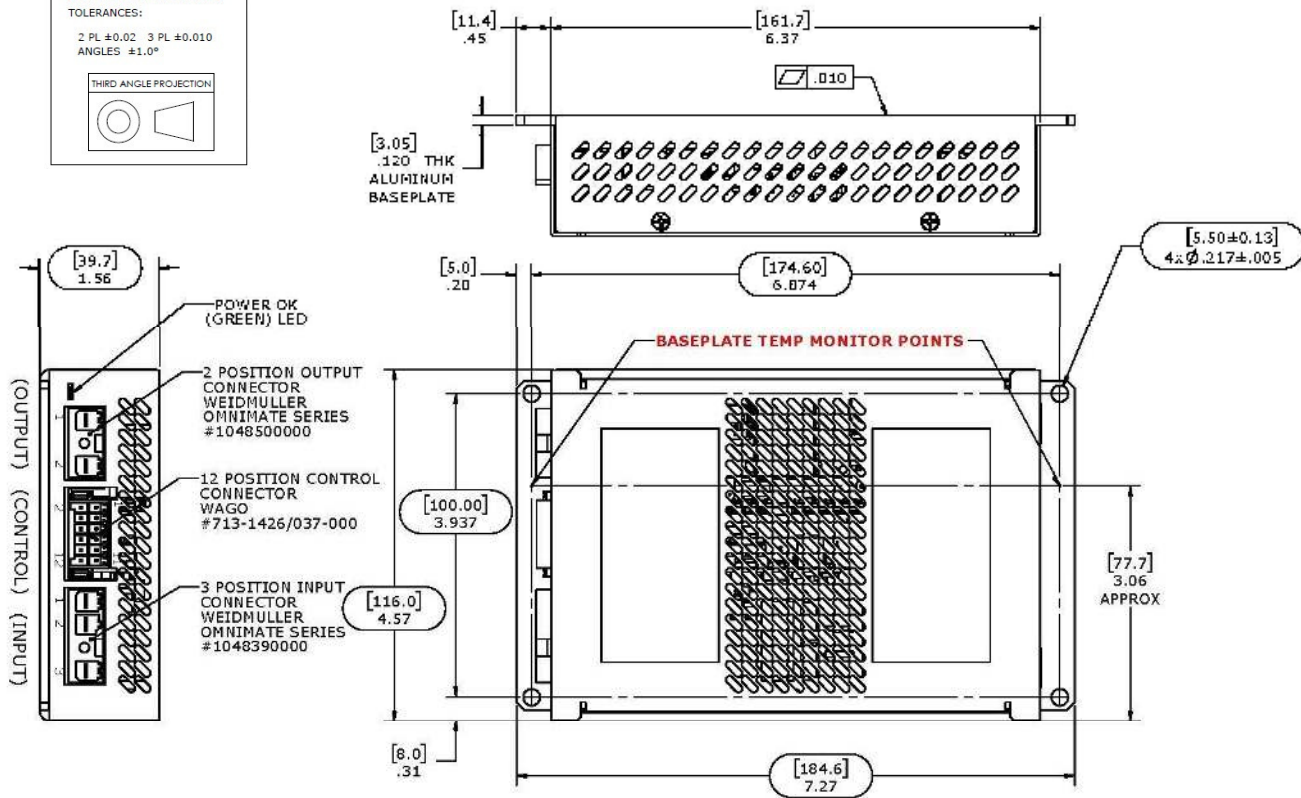

IP30 (2.5mm Objects*)

(*Will not permit parts larger than a standard M3 flat washer to fall inside)

PIN FUNCTION & DESCRIPTION (J3 CONTROL)

PIN 1: VO_UP, for output voltage adjustment. When a resistor is connected between VO_UP and VO_ADJ (PIN 3), the output voltage will be set to a value that is higher than nominal voltage (12V for IRV300-12, 24V for IRV300-24). When the connected resistor is zero (short-circuiting PIN 1 and PIN 3), the output voltage is set to maximum (13.8V for IRV300-12, 26.4V for IRV300-24 and 57V for IRV300-54).

PIN 2: P_OK+, open collector output. When the output voltage is higher than 10.5V for IRV300-12 (20.5V for IRV300-24 and 43.8V for IRV300-54), the voltage between P_OK+ (PIN 2) and VOUTN (PIN 4) is pull down to less than 0.8V.

PIN 3: VO_ADJ, for output voltage adjustment. Used with PIN 1 or PIN 5 to set the output voltage higher or lower than nominal voltage.

PIN 4: VOUTN, used with P_OK+ (PIN 2) for output voltage status. This pin is internally connected to the negative terminal of the output connector.

PIN 5: VO_DOWN, for output voltage adjustment. When a resistor is connected between VO_DOWN and VO_ADJ (PIN 3), the output voltage will be set to a value that is lower than nominal voltage. When the connected resistor is zero (short-circuiting PIN 5 and PIN 3), the output voltage is set to minimum (11V for IRV300-12, 21.6V for IRV300-24, 47V for IRV300-54).

PIN 6: LL_EN, for units with output ORing feature. Connect this pin to VOUTN (PIN 4) will enable output voltage droop with the increase of load current. This pin must be connected to VOUTN (PIN 4) before connecting outputs in parallel and enabling the ORing function.

PIN 7: and **PIN 8:** No connection

PIN 9: PUL1 and **PIN 10: PUL2**, for Programmable Under voltage Lockout (PUL).

PIN 11: ON/OFF+, for output inhibit. Output is OFF when this pin is pull down to lower than 0.8V with reference to VINN (PIN 12). For output ON state, leave this pin open or connect and keep its voltage higher than 4V.

PIN 12: VINN, this pin is internally connected to the negative terminal of the input connector.

J1 OUTPUT

PIN #	FUNCTION
1	+Vout
2	-Vout

J2 INPUT

PIN #	FUNCTION
1	-Vin
2	+Vin
3	GND

J3 CONTROL

PIN #	FUNCTION
1	VO_UP
2	P_OK+
3	VO_ADJ
4	VOUTN
5	VO_DOWN
6	LL_EN
7	No Connection
8	No Connection
9	PUL1
10	PUL2
11	ON/OFF+
12	VINN

IRV300-MCK (MATING CONNECTOR KIT)

- J1 MATE:** WEIDMULLER #1060550000
- J2 MATE:** WEIDMULLER #1060580000
- J3 MATE:** WAGO #713-1106/037-000

MPQ = 4 SETS

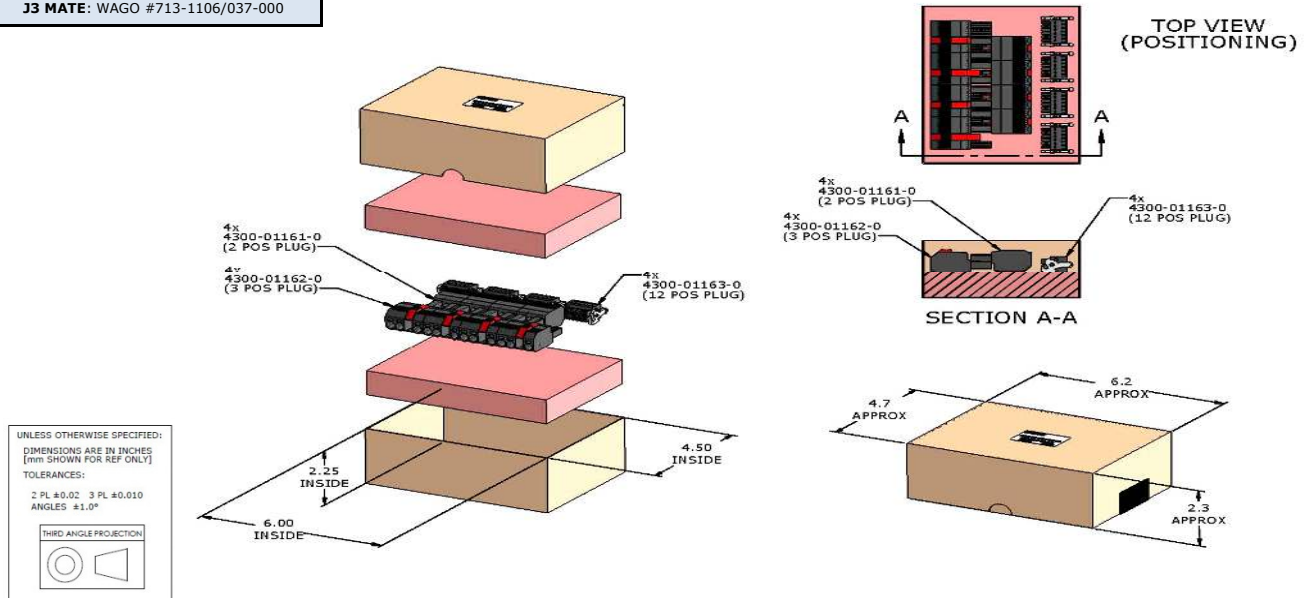

SHIPPING TRAYS AND BOX

MPQ = 4

BOX INSIDE DIMENSIONS:
12.6" (320mm) x 9.4" (238mm) x 6.14" (156mm)

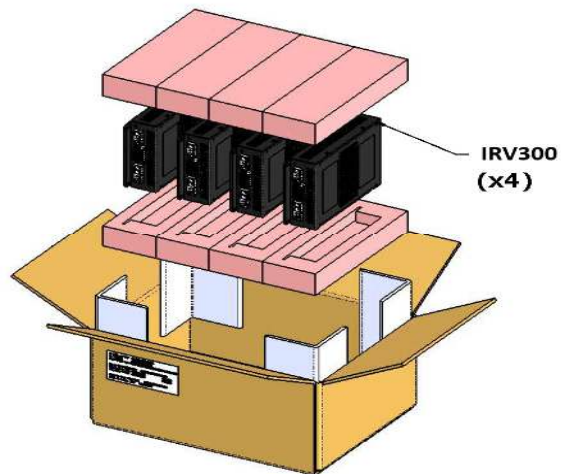

Murata Power Solutions, Inc.
129 Flanders Road, Westborough, MA 01581 USA
ISO 9001 and 14001 REGISTERED



This product is subject to the following [operating requirements](#) and the [Life and Safety Critical Application Sales Policy](#):
Refer to: <http://www.murata-ps.com/requirements/>

Murata Power Solutions, Inc. makes no representation that the use of its products in the circuits described herein, or the use of other technical information contained herein, will not infringe upon existing or future patent rights. The descriptions contained herein do not imply the granting of licenses to make, use, or sell equipment constructed in accordance therewith. Specifications are subject to change without notice.
© 2021 Murata Power Solutions, Inc.