

# XS1L04PB310

Inductive proximity sensors XS, inductive sensor XS1 Ø4, L28mm, brass, Sn1mm, 5..24VDC, cable 2m



## Main

Range of Product	Telemecanique Inductive proximity sensors XS
Series name	General purpose
Sensor Type	Inductive proximity sensor
Device Application	-
Sensor name	XS1
Sensor design	Cylindrical Ø 4 mm plain
Size	28 mm
Body type	Fixed
Detector flush mounting acceptance	Flush mountable
Material	Metal
Type of output signal	Discrete
Wiring Technique	3-wire
[Sn] nominal sensing distance	0.04 in (1 mm)
Discrete output function	1 NC
Output circuit type	DC
Discrete output type	PNP
Electrical connection	Cable
Cable length	6.56 ft (2 m)
[Us] rated supply voltage	5...24 V DC
Switching capacity in mA	<= 100 mA overload and short-circuit protection
IP degree of protection	IP67 conforming to IEC 60529

## Complementary

Detection face	Frontal
Front material	PPS
Enclosure Material	Nickel Plated Brass
Operating zone	0.00...0.03 in (0...0.8 mm)
Cable composition	3 x 0.11 mm <sup>2</sup>
Wire insulation material	PvR
Status LED	Output state 1 LED yellow)
Supply voltage limits	5...30 V DC
Switching frequency	<= 5000 Hz
Maximum voltage drop	<2 V closed)
Current consumption	<= 10 mA no-load
Maximum delay first up	5 ms
Maximum delay response	1 ms
Maximum delay recovery	1 ms
Marking	CE
Threaded length	0.00 in (0 mm)
Length	1.10 in (28 mm)
Net Weight	0.06 lb(US) (0.025 kg)

## Environment

Product Certifications	CSA UL
Ambient air temperature for operation	-13...158 °F (-25...70 °C)
Ambient Air Temperature for Storage	-40...185 °F (-40...85 °C)
Vibration resistance	25 gn +/- 2 mm 10...55 Hz)IEC 60068-2-6
Shock resistance	50 gn 11 ms IEC 60068-2-27

## Ordering and shipping details

Category	22486 - SENSORS, PROXIMITY
Discount Schedule	DS2
GTIN	3389110914788
Nbr. of units in pkg.	1
Package weight(Lbs)	0.99 oz (28 g)
Returnability	No
Country of origin	FR

## Packing Units

Unit Type of Package 1	PCE
Package 1 Height	0.79 in (2 cm)
Package 1 width	5.12 in (13 cm)
Package 1 Length	1.77 in (4.5 cm)

## Offer Sustainability

Sustainable offer status	Green Premium product
California proposition 65	WARNING: This product can expose you to chemicals including: Diisononyl phthalate (DINP), which is known to the State of California to cause cancer, and Di-isodecyl phthalate (DIDP), which is known to the State of California to cause birth defects or other reproductive harm. For more information go to <a href="http://www.P65Warnings.ca.gov">www.P65Warnings.ca.gov</a>
REACH Regulation	<a href="#">REACH Declaration</a>
EU RoHS Directive	Pro-active compliance (Product out of EU RoHS legal scope) <a href="#">EU RoHS Declaration</a>
Mercury free	Yes
RoHS exemption information	<a href="#">Yes</a>
Environmental Disclosure	<a href="#">Product Environmental Profile</a>
Circularity Profile	<a href="#">End Of Life Information</a>

## Contractual warranty

Warranty	18 months
----------	-----------

Dimensions

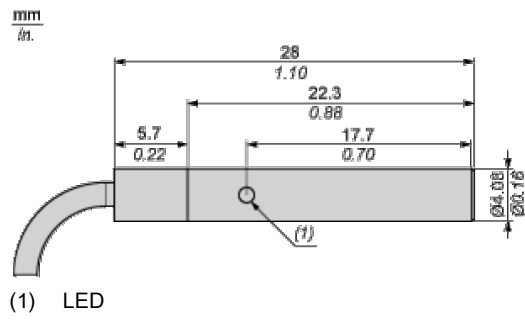

Minimum Mounting Distances in mm

Side by side

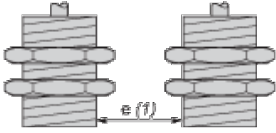

e (1) 2 mm/0.79 in.

≥

Face to face

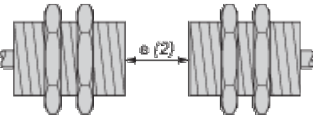

e (2) 12 mm/0.47 in.

≥

Facing a metal object

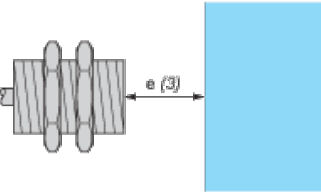

e (3) 3 mm/0.12 in.

≥

Mounted in a metal support

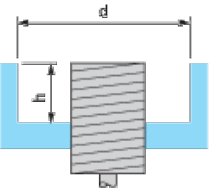

$d \geq 4 \text{ mm}/0.16 \text{ in.}$

$h \geq 0 \text{ mm}/0 \text{ in.}$

Tightening torque : 1.6 N.m. (values obtained with washers mounted)

Mounting

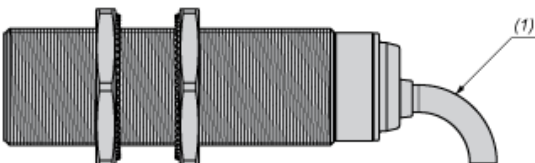

(1) Bending cable: 4 x external cable diameter

---

Wiring Schemes

---

PNP

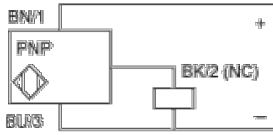

BU : Blue  
BN : Brown  
BK : Black

## Performance Curves

Standard Steel Target (mm) : 5x5x1

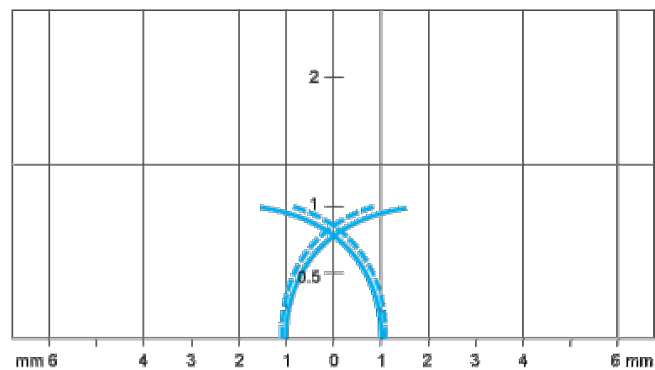

- Pick-up points
- - - Drop-out points (object approaching from the side)
- (y) Sensing distance in mm