

## Dual, 16-Bit, 12.6 GSPS RF DAC with Channelizers

### FEATURES

- ▶ Supports multiband wireless applications
  - ▶ 3 bypassable, complex data input channels per RF DAC
  - ▶ 1.54 GSPS maximum complex input data rate per input channel
  - ▶ 1 independent NCO per input channel
- ▶ Proprietary, low spurious and distortion design
  - ▶ 2-tone intermodulation distortion (IMD) = -83 dBc at 1.8 GHz, -7 dBFS/tone RF output
  - ▶ Spurious free dynamic range (SFDR) <-80 dBc at 1.8 GHz, -7 dBFS RF output
- ▶ Flexible 8-lane, 15.4 Gbps JESD204B interface
  - ▶ Supports single-band and multiband use cases
  - ▶ Supports 12-bit high density mode for increased data throughput
- ▶ Multiple chip synchronization
  - ▶ Supports JESD204B Subclass 1
- ▶ Selectable interpolation filter for a complete set of input data rates
  - ▶ 1x, 2x, 3x, 4x, 6x, and 8x configurable data channel interpolation
  - ▶ 1x, 2x, 4x, 6x, 8x, and 12x configurable final interpolation
- ▶ Final 48-bit NCO that operates at the DAC rate to support frequency synthesis up to 6 GHz
- ▶ Transmit enable function allows extra power saving and downstream circuitry protection
- ▶ High performance, low noise PLL clock multiplier
  - ▶ Supports 12.6 GSPS DAC update rate
  - ▶ Observation ADC clock driver with selectable divide ratios
- ▶ Low power
  - ▶ 2.55 W at 12 GSPS, dual channel mode
- ▶ 10 mm × 10 mm, 144-ball BGA\_ED with metal enhanced thermal lid, 0.80 mm pitch

### APPLICATIONS

- ▶ Wireless communications infrastructure
  - ▶ Multiband base station radios
  - ▶ Microwave/E-band backhaul systems
- ▶ Instrumentation, automatic test equipment (ATE)
- ▶ Radars and jammers

### GENERAL DESCRIPTION

The AD9172 is a high performance, dual, 16-bit digital-to-analog converter (DAC) that supports DAC sample rates to 12.6 GSPS. The device features an 8-lane, 15 Gbps JESD204B data input port, a high performance, on-chip DAC clock multiplier, and digital signal processing capabilities targeted at single-band and multiband direct to radio frequency (RF) wireless applications.

The AD9172 features three complex data input channels per RF DAC that are bypassable. Each data input channel includes a configurable gain stage, an interpolation filter, and a channel numerically controlled oscillator (NCO) for flexible, multiband frequency planning. The device supports up to a 1.5 GSPS complex data rate per input channel and is capable of aggregating multiple complex input data streams up to a maximum complex data rate of 1.5 GSPS. Additionally, the AD9172 supports ultrawide bandwidth modes bypassing the channelizers to provide maximum data rates of up to 3.08 GSPS (with 16-bit resolution) and 4.1 GSPS (with 12-bit resolution).

The AD9172 is available in a [144-ball BGA\\_ED](#) package.

### PRODUCT HIGHLIGHTS

1. Supports single-band and multiband wireless applications with three bypassable complex data input channels per RF DAC at a maximum complex input data rate of 1.5 GSPS. One independent NCO per input channel.
2. Ultrawide bandwidth channel bypass modes supporting up to 3 GSPS data rates with 16-bit resolution and 4 GSPS with 12-bit resolution.
3. Low power dual converter decreases the amount of power consumption needed in high bandwidth and multichannel applications.

## TABLE OF CONTENTS

Features .....	1	Serial Port Pin Descriptions.....	29
Applications.....	1	Serial Port Options.....	29
General Description .....	1	JESD204B Serial Data Interface.....	31
Product Highlights.....	1	JESD204B Overview.....	31
Functional Block Diagram.....	3	Physical Layer.....	35
Specifications.....	4	Data Link Layer.....	36
DC Specifications.....	4	Syncing LMFC Signals.....	39
Digital Specifications.....	5	Transport Layer.....	45
Maximum DAC Sampling Rate		JESD204B Test Modes .....	46
Specifications.....	5	JESD204B Error Monitoring.....	48
Power Supply DC Specifications.....	6	Digital Datapath.....	50
Serial Port and CMOS Pin Specifications.....	9	Total Datapath Interpolation.....	50
Digital Input Data Timing Specifications.....	10	Channel Digital Datapath.....	52
JESD204B Interface Electrical and Speed		Main Digital Datapath.....	55
Specifications .....	11	Interrupt Request Operation.....	61
Input Data Rates and Signal Bandwidth		Interrupt Service Routine .....	61
Specifications .....	12	Applications Information.....	62
AC Specifications .....	13	Hardware Considerations.....	62
Absolute Maximum Ratings.....	15	Analog Interface Considerations.....	65
Reflow Profile.....	15	DAC Input Clock Configurations.....	65
Thermal Characteristics.....	15	Clock Output Driver.....	67
ESD Caution.....	15	Analog Outputs.....	67
Pin Configuration and Function Descriptions.....	16	Start-Up Sequence.....	68
Typical Performance Characteristics .....	19	Register Summary.....	75
Terminology.....	25	Register Details.....	87
Theory of Operation.....	27	Outline Dimensions.....	146
Serial Port Operation.....	29	Ordering Guide.....	146
Data Format.....	29	Evaluation Boards.....	146

## REVISION HISTORY

**5/2022—Rev. B to Rev. C**

Deleted Figure 31 and Figure 32, Renumbered Sequentially.....	19
Changes to Table 49.....	68
Changes to Table 52 and Table 53.....	69
Changes to Table 58.....	74
Changes to Table 59.....	75
Changes to Table 60.....	87

FUNCTIONAL BLOCK DIAGRAM

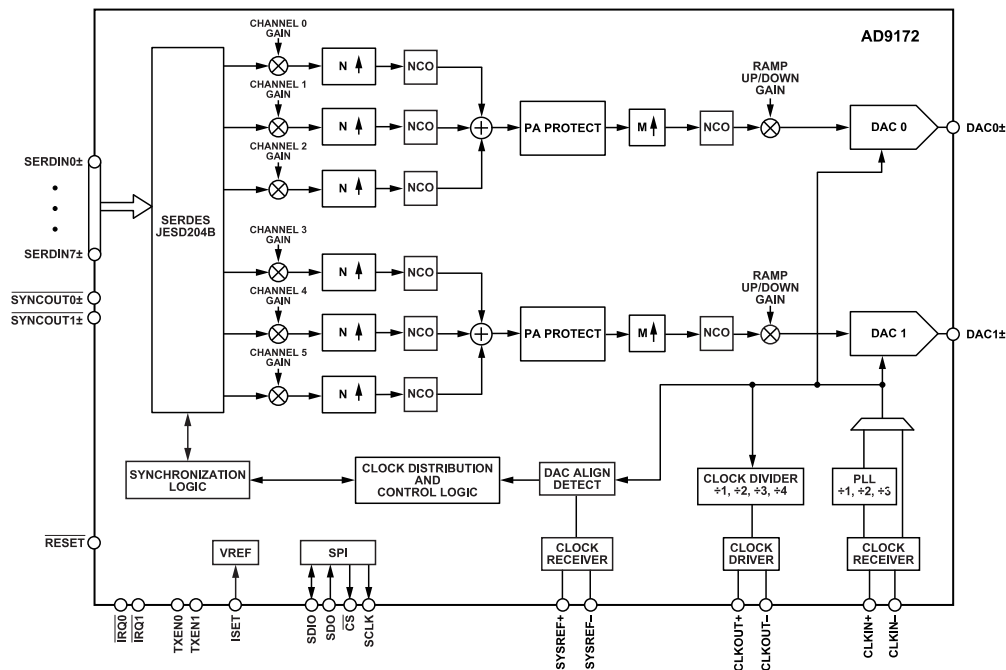

Figure 1.

001

## SPECIFICATIONS

## DC SPECIFICATIONS

AVDD1.0 = 1.0 V, AVDD1.8 = 1.8 V, DVDD1.0 = 1.0 V, DVDD1.8 = 1.8 V, SVDD1.0 = 1.0 V, and DAC output full-scale current ( $I_{OUTFS}$ ) = 20 mA, unless otherwise noted. For the minimum and maximum values,  $T_J = -40^{\circ}\text{C}$  to  $+118^{\circ}\text{C}$ . For the typical values,  $T_A = 25^{\circ}\text{C}$ , which corresponds to  $T_J = 51^{\circ}\text{C}$ .

Table 1.

Parameter	Test Conditions/Comments	Min	Typ	Max	Unit
RESOLUTION		16			Bit
ACCURACY					
Integral Nonlinearity (INL)			±7		LSB
Differential Nonlinearity (DNL)			±7		LSB
ANALOG OUTPUTS (DAC0+, DAC0-, DAC1+, DAC1-)					
Gain Error (with Internal ISET Reference)			±15		%
Full-Scale Output Current					
Minimum	$R_{SET} = 5\text{ k}\Omega$	14.2	16	17.8	mA
Maximum	$R_{SET} = 5\text{ k}\Omega$	23.6	26	28.8	mA
Common-Mode Voltage			0		V
Differential Impedance			100		$\Omega$
DAC DEVICE CLOCK INPUT (CLKIN+, CLKIN-)					
Differential Input Power	$R_{LOAD} = 100\ \Omega$ differential on-chip				
Minimum			0		dBm
Maximum			6		dBm
Differential Input Impedance <sup>1</sup>			100		$\Omega$
Common-Mode Voltage	AC-coupled		0.5		V
CLOCK OUTPUT DRIVER (CLKOUT+, CLKOUT-)					
Differential Output Power					
Minimum			-9		dBm
Maximum			0		dBm
Differential Output Impedance			100		$\Omega$
Common-Mode Voltage	AC-coupled		0.5		V
Output Frequency		727.5		3000	MHz
TEMPERATURE DRIFT					
Gain			10		ppm/ $^{\circ}\text{C}$
REFERENCE					
Internal Reference Voltage			0.495		V
ANALOG SUPPLY VOLTAGES					
AVDD1.0		0.95	1.0	1.05	V
AVDD1.8		1.71	1.8	1.89	V
DIGITAL SUPPLY VOLTAGES					
DVDD1.0		0.95	1.0	1.05	V
DAVDD1.0		0.95	1.0	1.05	V
DVDD1.8		1.71	1.8	1.89	V
SERIALIZER/DESERIALIZER (SERDES) SUPPLY VOLTAGES					
SVDD1.0		0.95	1.0	1.05	V

<sup>1</sup> See the [DAC Input Clock Configurations](#) section for more details.

## SPECIFICATIONS

## DIGITAL SPECIFICATIONS

AVDD1.0 = 1.0 V, AVDD1.8 = 1.8 V, DVDD1.0 = 1.0 V, DVDD1.8 = 1.8 V, SVDD1.0 = 1.0 V, and DAC output full-scale current ( $I_{OUTFS}$ ) = 20 mA, unless otherwise noted. For the minimum and maximum values,  $T_J = -40^{\circ}\text{C}$  to  $+118^{\circ}\text{C}$ . For the typical values,  $T_A = +25^{\circ}\text{C}$ , which corresponds to  $T_J = 51^{\circ}\text{C}$ .

Table 2.

Parameter	Test Conditions/Comments	Min	Typ	Max	Unit
DAC UPDATE RATE					
Minimum				2.91	GSPS
Maximum <sup>1</sup>	16-bit resolution, with interpolation	12.6			GSPS
	16-bit resolution, no interpolation	6.16			GSPS
Adjusted <sup>2</sup>	16-bit resolution, with interpolation	1.575			GSPS
	16-bit resolution, no interpolation	6.16			GSPS
DAC PHASE-LOCKED LOOP (PLL) VOLTAGE CONTROLLED OSCILLATOR (VCO) FREQUENCY RANGES					
VCO Output Divide by 1		8.74		12.42	GSPS
VCO Output Divide by 2		4.37		6.21	GSPS
VCO Output Divide by 3		2.91		4.14	GSPS
PHASE FREQUENCY DETECT INPUT FREQUENCY RANGES					
9.96 GHz ≤ VCO Frequency ≤ 10.87 GHz		25		225	MHz
VCO Frequency < 9.96 GHz or VCO Frequency > 10.87 GHz		25		770	MHz
DAC DEVICE CLOCK INPUT (CLKIN+, CLKIN-) FREQUENCY RANGES					
PLL Off		2.91		12.6	GHz
PLL On	M divider set to divide by 1	25		770	MHz
	M divider set to divide by 2	50		1540	MHz
	M divider set to divide by 3	75		2310	MHz
	M divider set to divide by 4	100		3080	MHz

<sup>1</sup> The maximum DAC update rate varies depending on the selected JESD204B mode and the lane rate for the given configuration used. The maximum DAC rate according to lane rate and voltage supply levels is listed in Table 3.

<sup>2</sup> The adjusted DAC update rate is calculated as  $f_{DAC}$ , divided by the minimum required interpolation factor for a given mode or the maximum channel data rate for a given mode. Different modes have different maximum DAC update rates, minimum interpolation factors, and maximum channel data rates, as shown in Table 13.

## MAXIMUM DAC SAMPLING RATE SPECIFICATIONS

AVDD1.0 = 1.0 V, AVDD1.8 = 1.8 V, DVDD1.0 = 1.0 V, DVDD1.8 = 1.8 V, SVDD1.0 = 1.0 V, and DAC output full-scale current ( $I_{OUTFS}$ ) = 20 mA, unless otherwise noted. For the minimum and maximum values,  $T_J = -40^{\circ}\text{C}$  to  $+118^{\circ}\text{C}$ . For the typical values,  $T_A = 25^{\circ}\text{C}$ , which corresponds to  $T_J = 51^{\circ}\text{C}$ .

Table 3.

Parameter	Test Conditions/Comments	Min	Typ	Max	Unit
MAXIMUM DAC UPDATE RATE					
SVDD1.0 = 1.0 V ± 5%	Lane rate > 11 Gbps	11.67			GSPS
	Lane rate ≤ 11 Gbps	12.37			GSPS
SVDD1.0 = 1.0 V ± 2.5%	Lane rate > 11 Gbps	11.79			GSPS

## SPECIFICATIONS

Table 3.

Parameter	Test Conditions/Comments	Min	Typ	Max	Unit
	Lane rate $\leq 11$ Gbps <sup>1</sup>	12.6			GSPS

<sup>1</sup> If using the on-chip PLL, the maximum DAC speed is limited to the maximum PLL speed of 12.42 GSPS, as listed in Table 2.

## POWER SUPPLY DC SPECIFICATIONS

AVDD1.0 = 1.0 V, AVDD1.8 = 1.8 V, DVDD1.0 = 1.0 V, DVDD1.8 = 1.8 V, SVDD1.0 = 1.0 V, and DAC output full-scale current ( $I_{OUTFS}$ ) = 20 mA, unless otherwise noted. For the minimum and maximum values,  $T_J = -40^\circ\text{C}$  to  $+118^\circ\text{C}$ . For the typical values,  $T_A = 25^\circ\text{C}$ , which corresponds to  $T_J = 51^\circ\text{C}$ .

Table 4.

Parameter	Test Conditions/Comments	Min	Typ	Max	Unit
<b>DUAL-LINK MODES</b>					
Mode 1 (L = 2, M = 4, NP = 16, N = 16)	11.7965 GSPS DAC rate, 184.32 MHz PLL reference clock, 32 $\times$ total interpolation (4 $\times$ , 8 $\times$ ), 40 MHz tone at -3 dBFS, channel gain = -6 dB, channel NCOs = $\pm 150$ MHz, main NCO = 2 GHz, SYNCOUTx $\pm$ in LVDS mode				
AVDD1.0	All supply levels set to nominal values		725	1020	mA
	All supply levels set to 5% tolerance		775	1120	mA
AVDD1.8			110	130	mA
DVDD1.0	Combined current consumption with the DAVDD1.0 supply				
	All supply levels set to nominal values		1270	1670	mA
	All supplies at 5% tolerance		1350	1850	mA
DVDD1.8			35	50	mA
SVDD1.0					
	All supply levels set to nominal values		290	510	mA
	All supplies at 5% tolerance		305	560	mA
Total Power Dissipation			2.55	3.38	W
Mode 4 (L = 4, M = 4, NP = 16, N = 16)	11.7965 GSPS DAC rate, 491.52 MHz PLL reference clock, 24 $\times$ total interpolation (3 $\times$ , 8 $\times$ ), 40 MHz tone at -3 dBFS, channel gain = -6 dB, channel NCOs = $\pm 150$ MHz, main NCO = 2 GHz, SYNCOUTx $\pm$ in LVDS mode				
AVDD1.0			725		mA
AVDD1.8			110		mA
DVDD1.0	Combined current consumption with the DAVDD1.0 supply		1340		mA
DVDD1.8			35		mA
SVDD1.0			425		mA
Total Power Dissipation			2.75		W
Mode 0 (L = 1, M = 2, NP = 16, N = 16)	5.89824 GSPS DAC rate, 184.32 MHz PLL reference clock, 16 $\times$ total interpolation (2 $\times$ , 8 $\times$ ), 40 MHz tone at -3 dBFS, channel NCO disabled, main NCO = 1.8425 GHz, SYNCOUTx $\pm$ in LVDS mode				
AVDD1.0	All supply levels set to nominal values		400	670	mA
	All supplies at 5% tolerance		425	745	mA
AVDD1.8			110	130	mA
DVDD1.0	Combined current consumption with the DAVDD1.0 supply				
	All supply levels set to nominal values		625	960	mA
	All supplies at 5% tolerance		670	1070	mA
DVDD1.8			35	50	mA
SVDD1.0			175	340	mA
Total Power Dissipation			1.45	2.15	W
Mode 3 (L = 2, M = 2, NP = 16, N = 16)	11.7965 GSPS DAC rate, 184.32 MHz PLL reference clock, 24 $\times$ total interpolation (3 $\times$ , 8 $\times$ ), 40 MHz tone at -3 dBFS, channel NCO disabled, main NCO = 2.655 GHz, SYNCOUTx $\pm$ in LVDS mode				

## SPECIFICATIONS

Table 4.

Parameter	Test Conditions/Comments	Min	Typ	Max	Unit
AVDD1.0	All supply levels set to nominal values		725		mA
	All supplies at 5% tolerance		775		mA
AVDD1.8			110		mA
DVDD1.0	Combined current consumption with the DAVDD1.0 supply				
	All supply levels set to nominal values		1175		mA
	All supplies at 5% tolerance		1250		mA
DVDD1.8			35		mA
SVDD1.0	All supply levels set to nominal values		245		mA
	All supplies at 5% tolerance		250		mA
Total Power Dissipation			2.4		W
Mode 9 (L = 4, M = 2, NP = 16, N = 16)	12 GSPS DAC rate, 187.5 MHz PLL reference clock, 8× total interpolation (1×, 8×), 10 MHz tone at -3 dBFS, channel NCO disabled, main NCO = 3.072 GHz, SYNCOUTx± in LVDS mode				
AVDD1.0	All supply levels set to nominal values		740	1030	mA
	All supplies at 5% tolerance		785	1135	mA
AVDD1.8			110	130	mA
DVDD1.0	Combined current consumption with the DAVDD1.0 supply				
	All supply levels set to nominal values		1170	1580	mA
	All supplies at 5% tolerance		1250	1740	mA
DVDD1.8			35	50	mA
SVDD1.0	All supply levels set to nominal values		530	840	mA
	All supplies at 5% tolerance		550	910	mA
Total Power Dissipation			2.7	3.63	W
Mode 2 (L = 3, M = 6, NP = 16, N = 16)	12 GSPS DAC rate, 375 MHz PLL reference clock, 48× total interpolation (6×, 8×), 30 MHz tone at -3 dBFS, channel gain = -11 dB, channel NCOs = 20 MHz, main NCO = 2.1 GHz				
AVDD1.0	All supply levels set to nominal values		735	1030	mA
	All supplies at 5% tolerance		785	1135	mA
AVDD1.8			110	130	mA
DVDD1.0	Combined current consumption with the DAVDD1.0 supply				
	All supply levels set to nominal values		1370	1800	mA
	All supplies at 5% tolerance		1460	1980	mA
DVDD1.8			35	50	mA
SVDD1.0	All supply levels set to nominal values		410	680	mA
	All supplies at 5% tolerance		430	755	mA
Total Power Dissipation			2.77	3.69	W
SINGLE-LINK MODES					
Mode 20 (L = 8, M = 1, NP = 16, N = 16)	6 GSPS DAC rate, 187.5 MHz PLL reference clock, 1× total interpolation (1×, 1×), 1.8 GHz tone at -3 dBFS, channel and main NCOs disabled				
AVDD1.0	All supply levels set to nominal values		400	670	mA
	All supplies at 5% tolerance		430	745	mA
AVDD1.8			75	100	mA
DVDD1.0	Combined current consumption with the DAVDD1.0 supply				
	All supply levels set to nominal values		400	700	mA
	All supplies at 5% tolerance		420	810	mA
DVDD1.8			35	50	mA
SVDD1.0	All supply levels set to nominal values		525	820	mA
	All supplies at 5% tolerance		550	880	mA
Total Power Dissipation			1.5	2.34	W

## SPECIFICATIONS

Table 4.

Parameter	Test Conditions/Comments	Min	Typ	Max	Unit
Mode 12 (L = 8, M = 2, NP = 12, N = 12)	4 GSPS DAC rate, 187.5 MHz PLL reference clock, 1× total interpolation (1×, 1×), 1 GHz tone at -3 dBFS, channel and main NCOs disabled				
AVDD1.0	All supply levels set to nominal values		300	550	mA
	All supplies at 5% tolerance		315	620	mA
AVDD1.8			75	100	mA
DVDD1.0	Combined current consumption with the DAVDD1.0 supply				
	All supply levels set to nominal values		325	630	mA
	All supplies at 5% tolerance		340	725	mA
DVDD1.8			35	50	mA
SVDD1.0	All supply levels set to nominal values		525	820	mA
	All supplies at 5% tolerance		550	880	mA
Total Power Dissipation			1.32	2.15	W
DUAL-LINK, MODE 3 (NCO ONLY, SINGLE-CHANNEL MODE, NO SERDES)	6 GSPS DAC rate, 300 MHz PLL reference clock, 8× total interpolation (1×, 8×), no input tone (dc internal level = 0x50FF), channel NCO = 40 MHz, main NCO = 1.8425 GHz				
Mode 3					
AVDD1.0	All supply levels set to nominal values		410	660	mA
	All supplies at 5% tolerance		435	750	mA
AVDD1.8			110	130	mA
DVDD1.0	Combined current consumption with the DAVDD1.0 supply				
	All supply levels set to nominal values		500	780	mA
	All supplies at 5% tolerance		515	950	mA
DVDD1.8			0.3	1	mA
SVDD1.0	All supply levels set to nominal values		5	100	mA
	All supplies at 5% tolerance		3	120	mA
Total Power Dissipation			1.1	1.671	W
DUAL-LINK, MODE 4 (NCO ONLY, DUAL-CHANNEL MODE, NO SERDES)	12 GSPS DAC rate, 500 MHz PLL reference clock, 32× total interpolation (4×, 8×), no input tone (dc internal level = 0x2AFF), channel NCOs = ±150 MHz, main NCO = 2 GHz				
Mode 4					
AVDD1.0	All supply levels set to nominal values		750	1030	mA
	All supplies at 5% tolerance		790	1130	mA
AVDD1.8			110	130	mA
DVDD1.0	Combined current consumption with the DAVDD1.0 supply				
	All supply levels set to nominal values		1200	1590	mA
	All supplies at 5% tolerance		1300	1750	mA
DVDD1.8			0.3	1	mA
SVDD1.0	All supply levels set to nominal values		5	100	mA
Total Power Dissipation			2.2	2.851	W



## SPECIFICATIONS

## SERIAL PORT AND CMOS PIN SPECIFICATIONS

AVDD1.0 = 1.0 V, AVDD1.8 = 1.8 V, DVDD1.0 = 1.0 V, DVDD1.8 = 1.8 V, SVDD1.0 = 1.0 V, and DAC output full-scale current ( $I_{OUTFS}$ ) = 20 mA, unless otherwise noted. For the minimum and maximum values,  $T_J = -40^{\circ}\text{C}$  to  $+118^{\circ}\text{C}$ . For the typical values,  $T_A = 25^{\circ}\text{C}$ , which corresponds to  $T_J = 51^{\circ}\text{C}$ .

Table 5.

Parameter	Symbol	Test Comments/Conditions	Min	Typ	Max	Unit
<b>WRITE OPERATION</b>						
Maximum SCLK Clock Rate	$f_{SCLK}, 1/t_{SCLK}$	See Figure 43	80			MHz
SCLK Clock High	$t_{PWH}$	SCLK = 20 MHz	5.03			ns
SCLK Clock Low	$t_{PWL}$	SCLK = 20 MHz	1.6			ns
SDIO to SCLK Setup Time	$t_{DS}$		1.154			ns
SCLK to SDIO Hold Time	$t_{DH}$		0.577			ns
$\overline{CS}$ to SCLK Setup Time	$t_S$		1.036			ns
SCLK to $\overline{CS}$ Hold Time	$t_H$		-5.3			ps
<b>READ OPERATION</b>						
SCLK Clock Rate	$f_{SCLK}, 1/t_{SCLK}$	See Figure 42			48.58	MHz
SCLK Clock High	$t_{PWH}$		5.03			ns
SCLK Clock Low	$t_{PWL}$		1.6			ns
SDIO to SCLK Setup Time	$t_{DS}$		1.158			ns
SCLK to SDIO Hold Time	$t_{DH}$		0.537			ns
$\overline{CS}$ to SCLK Setup Time	$t_S$		1.036			ns
SCLK to SDIO Data Valid Time	$t_{DV}$		9.6			ns
SCLK to SDO Data Valid Time	$t_{DV}$		13.7			ns
$\overline{CS}$ to SDIO Output Valid to High-Z		Not shown in Figure 42 or Figure 43	5.4			ns
$\overline{CS}$ to SDO Output Valid to High-Z		Not shown in Figure 42 or Figure 43	9.59			ns
<b>INPUTS (SDIO, SCLK, <math>\overline{CS}</math>, RESET, TXEN0, and TXEN1)</b>						
Voltage Input						
High	$V_{IH}$		1.48			V
Low	$V_{IL}$				0.425	V
Current Input						
High	$I_{IH}$				$\pm 100$	nA
Low	$I_{IL}$		$\pm 100$			nA
<b>OUTPUTS (SDIO, SDO)</b>						
Voltage Output						
High	$V_{OH}$		1.69			V
0 mA load						V
4 mA load			1.52			V
Low	$V_{OL}$				0.045	V
0 mA load						V
4 mA load					0.175	V
Current Output						
High	$I_{OH}$			4		mA
Low	$I_{OL}$			4		mA
<b>INTERRUPT OUTPUTS (IRQ0, IRQ1)</b>						
Voltage Output						
High	$V_{OH}$		1.71			V
Low	$V_{OL}$				0.075	V

## SPECIFICATIONS

## DIGITAL INPUT DATA TIMING SPECIFICATIONS

AVDD1.0 = 1.0 V, AVDD1.8 = 1.8 V, DVDD1.0 = 1.0 V, DVDD1.8 = 1.8 V, SVDD1.0 = 1.0 V, and DAC output full-scale current ( $I_{OUTFS}$ ) = 20 mA, unless otherwise noted. For the minimum and maximum values,  $T_J = -40^{\circ}\text{C}$  to  $+118^{\circ}\text{C}$ . For the typical values,  $T_A = 25^{\circ}\text{C}$ , which corresponds to  $T_J = 51^{\circ}\text{C}$ .

Table 6.

Parameter	Test Conditions/Comments	Min	Typ	Max	Unit
LATENCY <sup>1</sup>					
Channel Interpolation Factor, Main Datapath Interpolation Factor	LMFC_VAR_x = 12, LMFC_DELAY_x = 12, unless otherwise noted				
1x, 1x <sup>2</sup>	JESD204B Mode 10 <sup>3</sup> , Mode 18 <sup>3</sup>		420		DAC clock cycle
	JESD204B Mode 11, Mode 19		440		DAC clock cycle
	JESD204B Mode 12, Mode 19		590		DAC clock cycle
	JESD204B Mode 20 <sup>3</sup>		700		DAC clock cycle
	JESD204B Mode 21		750		DAC clock cycle
1x, 2x <sup>2</sup>	JESD204B Mode 8 <sup>3</sup>		670		DAC clock cycle
	JESD204B Mode 9		700		DAC clock cycle
1x, 4x <sup>2</sup>	JESD204B Mode 8 <sup>3</sup>		1090		DAC clock cycle
	JESD204B Mode 9		1140		DAC clock cycle
1x, 6x <sup>2</sup>	JESD204B Mode 8 <sup>3</sup>		1460		DAC clock cycle
	JESD204B Mode 9		1530		DAC clock cycle
1x, 8x <sup>2</sup>	JESD204B Mode 3		1390		DAC clock cycle
	JESD204B Mode 8 <sup>3</sup>		1820		DAC clock cycle
	JESD204B Mode 9		1920		DAC clock cycle
1x, 12x <sup>2</sup>	JESD204B Mode 8 <sup>3</sup>		2700		DAC clock cycle
	JESD204B Mode 9		2840		DAC clock cycle
2x, 6x <sup>2</sup>	JESD204B Mode 3, Mode 4		1970		DAC clock cycle
	JESD204B Mode 5		1770		DAC clock cycle
2x, 8x <sup>2</sup>	JESD204B Mode 0		2020		DAC clock cycle
	JESD204B Mode 3, Mode 4		2500		DAC clock cycle
3x, 6x <sup>2</sup>	JESD204B Mode 3, Mode 4		2880		DAC clock cycle
	JESD204B Mode 5, Mode 6		2630		DAC clock cycle
3x, 8x <sup>2</sup>	JESD204B Mode 3, Mode 4		3310		DAC clock cycle
	JESD204B Mode 5, Mode 6		2980		DAC clock cycle
4x, 6x <sup>2</sup>	JESD204B Mode 0, Mode 1, Mode 2		2410		DAC clock cycle
4x, 8x <sup>2</sup>	JESD204B Mode 0, Mode 1, Mode 2		3090		DAC clock cycle
6x, 6x <sup>2</sup>	JESD204B Mode 0, Mode 1, Mode 2		3190		DAC clock cycle
6x, 8x <sup>2</sup>	JESD204B Mode 0, Mode 1, Mode 2		4130		DAC clock cycle
8x, 6x <sup>2</sup>	JESD204B Mode 7		3300		DAC clock cycle
8x, 8x <sup>2</sup>	JESD204B Mode 7		4270		DAC clock cycle
DETERMINISTIC LATENCY					
Fixed				13	PCLK <sup>4</sup>
Variable				2	PCLK cycles
SYSREF± TO LMFC DELAY			0		DAC clock cycles

<sup>1</sup> Total latency (or pipeline delay) through the device is calculated as follows: total latency = interface latency + fixed latency + variable latency + pipeline delay.

<sup>2</sup> The first value listed in this specification is the channel interpolation factor, and the second value is the main datapath interpolation factor.

<sup>3</sup> LMFC\_VAR\_x = 7 and LMFC\_DELAY\_x = 4

<sup>4</sup> PCLK is the internal processing clock for the AD9172 and equals the lane rate ÷ 40.

## SPECIFICATIONS

## JESD204B INTERFACE ELECTRICAL AND SPEED SPECIFICATIONS

AVDD1.0 = 1.0 V, AVDD1.8 = 1.8 V, DVDD1.0 = 1.0 V, DVDD1.8 = 1.8 V, SVDD1.0 = 1.0 V, and DAC output full-scale current ( $I_{OUTFS}$ ) = 20 mA, unless otherwise noted. For the minimum and maximum values,  $T_J = -40^{\circ}\text{C}$  to  $+118^{\circ}\text{C}$ . For the typical values,  $T_A = 25^{\circ}\text{C}$ , which corresponds to  $T_J = 51^{\circ}\text{C}$ .

Table 7.

Parameter	Symbol	Test Conditions/Comments	Min	Typ	Max	Unit
JESD204B SERIAL INTERFACE RATE (SERIAL LANE RATE)			3		15.4	Gbps
JESD204B DATA INPUTS						
Input Leakage Current		$T_A = 25^{\circ}\text{C}$				
Logic High		Input level = $1.0\text{ V} \pm 0.25\text{ V}$		10		$\mu\text{A}$
Logic Low		Input level = $0\text{ V}$		-4		$\mu\text{A}$
Unit Interval	UI		333		66.7	ps
Common-Mode Voltage	$V_{RCM}$	AC-coupled	-0.05		+1.1	V
Differential Voltage	$R_{V_{DIFF}}$		110		1050	mV
Differential Impedance	$Z_{R_{DIFF}}$	At dc	80	100	120	$\Omega$
SYSREF $\pm$ INPUT						
Differential Impedance				100		$\Omega$
DIFFERENTIAL OUTPUTS (SYNCOUT0 $\pm$ , SYNCOUT1 $\pm$ ) <sup>1</sup>						
Output Differential Voltage	$V_{OD}$	Driving $100\ \Omega$ differential load	320	390	460	mV
Output Offset Voltage	$V_{OS}$		1.08	1.12	1.15	V
SINGLE-ENDED OUTPUTS (SYNCOUT0 $\pm$ , SYNCOUT1 $\pm$ )						
Output Voltage		Driving $100\ \Omega$ differential load				
High	$V_{OH}$		1.69			V
Low	$V_{OL}$				0.045	V
Current Output						
High	$I_{OH}$			0		mA
Low	$I_{OL}$			0		mA

<sup>1</sup> IEEE Standard 1596.3 LVDS compatible.

## SPECIFICATIONS

## INPUT DATA RATES AND SIGNAL BANDWIDTH SPECIFICATIONS

AVDD1.0 = 1.0 V, AVDD1.8 = 1.8 V, DVDD1.0 = 1.0 V, DVDD1.8 = 1.8 V, SVDD1.0 = 1.0 V, and DAC output full-scale current ( $I_{OUTFS}$ ) = 20 mA, unless otherwise noted. For the minimum and maximum values,  $T_J = -40^{\circ}\text{C}$  to  $+118^{\circ}\text{C}$ . For the typical values,  $T_A = 25^{\circ}\text{C}$ , which corresponds to  $T_J = 51^{\circ}\text{C}$ .

Table 8.

Parameter <sup>1</sup>	Test Conditions/Comments	Min	Typ	Max	Unit
INPUT DATA RATE PER INPUT CHANNEL	Channel datapaths bypassed (1× interpolation), single-DAC mode, 16-bit resolution			6160	MSPS
	Channel datapaths bypassed (1× interpolation), dual DAC mode, 16-bit resolution			3080	MSPS
	Channel datapaths bypassed (1× interpolation), dual DAC mode, 12-bit resolution			4100	MSPS
	1 complex channel enabled			1540	MSPS
	2 complex channels enabled			770	MSPS
	3 complex channels enabled			385	MSPS
COMPLEX SIGNAL BANDWIDTH PER INPUT CHANNEL	1 complex channel enabled ( $0.8 \times f_{DATA}$ )			1232	MHz
	2 complex channels enabled ( $0.8 \times f_{DATA}$ )			616	MHz
	3 complex channels enabled ( $0.8 \times f_{DATA}$ )			308	MHz
MAXIMUM NCO CLOCK RATE	Channel NCO			1540	MHz
	Main NCO			12.6	GHz
MAXIMUM NCO SHIFT FREQUENCY RANGE	Channel NCO	Channel summing node = 1.575 GHz, channel interpolation rate > 1×	-770	+770	MHz
	Main NCO	$f_{DAC} = 12.6$ GHz, main interpolation rate > 1×	-6.3	+6.3	GHz
MAXIMUM FREQUENCY SPACING ACROSS INPUT CHANNELS	Maximum NCO output frequency × 0.8			1232	MHz

<sup>1</sup> Values listed for these parameters are the maximum possible when considering all JESD204B modes of operation. Some modes are more limiting, based on other parameters.

## SPECIFICATIONS

## AC SPECIFICATIONS

AVDD1.0 = 1.0 V, AVDD1.8 = 1.8 V, DVDD1.0 = 1.0 V, DVDD1.8 = 1.8 V, SVDD1.0 = 1.0 V, and DAC output full-scale current ( $I_{OUTFS}$ ) = 20 mA, unless otherwise noted. For the minimum and maximum,  $T_J$  =  $-40^{\circ}\text{C}$  to  $+118^{\circ}\text{C}$ . For the typical values,  $T_A$  =  $25^{\circ}\text{C}$ , which corresponds to  $T_J$  =  $51^{\circ}\text{C}$ .

Table 9.

Parameter	Test Conditions/Comments	Min	Typ	Max	Unit
<b>SPURIOUS-FREE DYNAMIC RANGE (SFDR)</b>					
Single Tone, $f_{DAC}$ = 12000 MSPS, Mode 1 (L = 2, M = 4)	-7 dBFS, shuffle enabled				
$f_{OUT}$ = 100 MHz			-81		dBc
$f_{OUT}$ = 500 MHz			-80		dBc
$f_{OUT}$ = 950 MHz			-75		dBc
$f_{OUT}$ = 1840 MHz			-80		dBc
$f_{OUT}$ = 2650 MHz			-75		dBc
$f_{OUT}$ = 3700 MHz			-67		dBc
Single Tone, $f_{DAC}$ = 6000 MSPS, Mode 0 (L = 1, M = 2)	-7 dBFS, shuffle enabled				
$f_{OUT}$ = 100 MHz			-85		dBc
$f_{OUT}$ = 500 MHz			-85		dBc
$f_{OUT}$ = 950 MHz			-78		dBc
$f_{OUT}$ = 1840 MHz			-75		dBc
$f_{OUT}$ = 2650 MHz			-69		dBc
Single Tone, $f_{DAC}$ = 3000 MSPS, Mode 10 (L = 8, M = 2)	-7 dBFS, shuffle enabled				
$f_{OUT}$ = 100 MHz			-87		dBc
$f_{OUT}$ = 500 MHz			-84		dBc
$f_{OUT}$ = 950 MHz			-81		dBc
Single-Band Application—Band 3 (1805 MHz to 1880 MHz)	Mode 0, $2\times$ to $8\times$ , $f_{DAC}$ = 6000 MSPS, 368.64 MHz reference clock				
SFDR Harmonics	-7 dBFS, shuffle enabled				
In-Band			-82		dBc
Digital Predistortion (DPD) Band	DPD bandwidth = data rate $\times$ 0.8		-80		dBc
Second Harmonic			-82		dBc
Third Harmonic			-80		dBc
Fourth and Fifth Harmonic			-95		dBc
SFDR Nonharmonics	-7 dBFS, shuffle enabled				
In-Band			-74		dBc
DPD Band			-74		dBc
<b>ADJACENT CHANNEL LEAKAGE RATIO</b>					
4C-WCDMA	-1 dBFS digital backoff				
$f_{DAC}$ = 1200 MSPS, Mode 1 (L = 2, M = 4)	$f_{OUT}$ = 1840 MHz		-70		dBc
	$f_{OUT}$ = 2650 MHz		-68		dBc
	$f_{OUT}$ = 3500 MHz		-66		dBc
$f_{DAC}$ = 6000 MSPS, Mode 0 (L = 1, M = 2)	$f_{OUT}$ = 1840 MHz		-71		dBc
	$f_{OUT}$ = 2650 MHz		-66		dBc
<b>THIRD-ORDER INTERMODULATION DISTORTION</b>					
$f_{DAC}$ = 12000 MSPS, Mode 1 (L = 2, M = 4)	Two-tone test, -7 dBFS/tone, 1 MHz spacing				
	$f_{OUT}$ = 1840 MHz		-83		dBc
	$f_{OUT}$ = 2650 MHz		-85		dBc
	$f_{OUT}$ = 3700 MHz		-77		dBc
$f_{DAC}$ = 6000 MSPS, Mode 0 (L = 1, M = 2)	$f_{OUT}$ = 1840 MHz		-74		dBc
	$f_{OUT}$ = 2650 MHz		-72		dBc
NOISE SPECTRAL DENSITY (NSD)	0 dBFS, NSD measurement taken at 10% away from $f_{OUT}$ , shuffle on				

## SPECIFICATIONS

Table 9.

Parameter	Test Conditions/Comments	Min	Typ	Max	Unit
Single Tone, $f_{DAC} = 12000$ MSPS					
$f_{OUT} = 200$ MHz			-163		dBc/Hz
$f_{OUT} = 500$ MHz			-163		dBc/Hz
$f_{OUT} = 950$ MHz			-162		dBc/Hz
$f_{OUT} = 1850$ MHz			-160		dBc/Hz
$f_{OUT} = 2150$ MHz			-158		dBc/Hz
Single Tone, $f_{DAC} = 6000$ MSPS					
$f_{OUT} = 200$ MHz			-164		dBc/Hz
$f_{OUT} = 500$ MHz			-163		dBc/Hz
$f_{OUT} = 950$ MHz			-161		dBc/Hz
$f_{OUT} = 1850$ MHz			-157		dBc/Hz
$f_{OUT} = 2150$ MHz			-155		dBc/Hz
Single Tone, $f_{DAC} = 3000$ MSPS					
$f_{OUT} = 200$ MHz			-163		dBc/Hz
$f_{OUT} = 500$ MHz			-159		dBc/Hz
$f_{OUT} = 950$ MHz			-155		dBc/Hz
SINGLE-SIDEBAND PHASE NOISE OFFSET	Loop filter component values according to Figure 84 are as follows: $C1 = 22$ nF, $R1 = 232$ $\Omega$ , $C2 = 2.4$ nF, $C3 = 33$ nF; PFD frequency = 500 MHz, $f_{OUT} = 1.8$ GHz, $f_{DAC} = 12$ GHz				
1 kHz			-97		dBc/Hz
10 kHz			-105		dBc/Hz
100 kHz			-114		dBc/Hz
600 kHz			-126		dBc/Hz
1.2 MHz			-133		dBc/Hz
1.8 MHz			-137		dBc/Hz
6 MHz			-148		dBc/Hz
DAC TO DAC OUTPUT ISOLATION	Taken using the AD9172-FMC-EBZ evaluation board				
Dual Band— $f_{DAC} = 12000$ MSPS, Mode 1 ( $L = 2$ , $M = 4$ )					
	$f_{OUT} = 1840$ MHz		-77		dB
	$f_{OUT} = 2650$ MHz		-70		dB
	$f_{OUT} = 3700$ MHz		-68		dB

## ABSOLUTE MAXIMUM RATINGS

Table 10.

Parameter	Rating
ISET, FILT_COARSE, FILT_BYP, FILT_VCM	-0.3 V to AVDD1.8 + 0.3 V
SERDINx±	-0.2 V to SVDD1.0 + 0.2 V
SYNCOUT0±, SYNCOUT1±, RESET, TXEN0, TXEN1, IRQ0, IRQ1, CS, SCLK, SDIO, SDO	-0.3 V to DVDD1.8 + 0.3 V
DAC0±, DAC1±, CLKIN±, CLKOUT±, FILT_FINE	-0.2 V to AVDD1.0 + 0.2 V
SYSREF±	-0.2 V to DVDD1.0 + 0.2 V
AVDD1.0, DVDD1.0, SVDD1.0 to GND	-0.2 V to +1.2 V
AVDD1.8, DVDD1.8 to GND	-0.3 V to 2.2 V
Maximum Junction Temperature (T <sub>J</sub> ) <sup>1</sup>	118°C
Storage Temperature Range	-65°C to +150°C
Reflow	260°C

<sup>1</sup> Some operating modes of the device may cause the device to approach or exceed the maximum junction temperature during operation at supported ambient temperatures. Removal of heat from the device may require additional measures such as active airflow, heat sinks, or other measures.

Stresses at or above those listed under Absolute Maximum Ratings may cause permanent damage to the product. This is a stress rating only; functional operation of the product at these or any other conditions above those indicated in the operational section of this specification is not implied. Operation beyond the maximum operating conditions for extended periods may affect product reliability.

## REFLOW PROFILE

The AD9172 reflow profile is in accordance with the JEDEC JESD20 criteria for Pb-free devices. The maximum reflow temperature is 260°C.

## THERMAL CHARACTERISTICS

Thermal performance is directly linked to printed circuit board (PCB) design and operating environment. Careful attention to PCB thermal design is required.

$\theta_{JA}$  is the natural convection junction to ambient thermal resistance measured in a one cubic foot sealed enclosure.  $\theta_{JC}$  is the junction to case thermal resistance.

Thermal resistances and thermal characterization parameters are specified vs. the number of PCB layers in different airflow velocities (in m/sec). The use of appropriate thermal management techniques is recommended to ensure that the maximum junction temperature does not exceed the limits shown in Table 10.

Use the values in Table 11 in compliance with JEDEC 51-12.

Table 11. Simulated Thermal Resistance vs. PCB Layers<sup>1</sup>

PCB Type	Airflow Velocity (m/sec)	$\theta_{JA}$	$\theta_{JC\_TOP}$	$\theta_{JC\_BOT}$	Unit
JEDEC 2s2p Board	0.0	25.3	2.4 <sup>2</sup>	3.0 <sup>3</sup>	°C/W
	1.0	22.6	N/A	N/A	°C/W
	2.5	21.0	N/A	N/A	°C/W
12-Layer PCB <sup>4</sup>	0.0	15.4	2.4	2.6	°C/W
	1.0	13.1	N/A	N/A	°C/W
	2.5	11.6	N/A	N/A	°C/W

<sup>1</sup> N/A means not applicable.

<sup>2</sup> 1SOP PCB with no vias in PCB.

<sup>3</sup> 1SOP PCB with 7 × 7 standard JEDEC vias.

<sup>4</sup> Non JEDEC thermal resistance.

## ESD CAUTION



**ESD (electrostatic discharge) sensitive device.** Charged devices and circuit boards can discharge without detection. Although this product features patented or proprietary protection circuitry, damage may occur on devices subjected to high energy ESD.

Therefore, proper ESD precautions should be taken to avoid performance degradation or loss of functionality.

PIN CONFIGURATION AND FUNCTION DESCRIPTIONS



Figure 2. Pin Configuration

Table 12. Pin Function Descriptions

Pin No.	Mnemonic	Description
1.0 V Supply		
H3, H4, H5, H8 to H10, J6, M2, M11	AVDD1.0	1.0 V Clock and Analog Supplies. These pins supply the clock receivers, clock distribution, the on-chip DAC clock multiplier, and the DAC analog core. Clean power supply rail sources are required on these pins.
F5 to F8	DVDD1.0	1.0 V Digital Supplies. These pins supply power to the DAC digital circuitry. Clean power supply rail sources are required on these pins.
F4, F9	DAVDD1.0	1.0 V Digital to Analog Supplies. These pins can share a supply rail with the DVDD1.0 supply (electrically connected) but must have separate supply plane and decoupling capacitors for the PCB layout to improve isolation for these two pins. Clean power supply rail sources are required on these pins.
C1, C2, C5, C7, C8, C11, C12, D6	SVDD1.0	1.0 V SERDES Supplies to the JESD204B Data Interface. Clean power supply rail sources are required on these pins.
1.8 V Supply		
K3, K5, K7, K10, L3, L6, L7, L10	AVDD1.8	1.8 V Analog Supplies to the On-Chip DAC Clock Multiplier and the DAC Analog Core. Clean power supply rail sources are required on these pins.
C6, D3, D10, E3, E10	DVDD1.8	1.8 V Digital Supplies to the JESD204B Data Interface and the Other Input/Output Circuitry, Such as the Serial Port Interface (SPI). Clean power supply rail sources are required on these pins.
Ground		
A1, A6, A7, A12, B1, B6, B7, B12, C3, C4, C9, C10, D5, D7, F1 to F3, F10 to F12, G1 to G12, H11, J1, J3 to J5, J8 to J11, K2, K8, K9, K11, K12, L2, L4, L5, L8, L9, L11, M1, M3, M6, M7, M10, M12	GND	Device Common Ground.
RF Clock		
J12	CLKIN+	Positive Device Clock Input. This pin is the clock input for the on-chip DAC clock multiplier, REFCLK, when the DAC PLL is on. This pin is also the clock input for the DAC sample clock or



## PIN CONFIGURATION AND FUNCTION DESCRIPTIONS

Table 12. Pin Function Descriptions

Pin No.	Mnemonic	Description
H12	CLKIN-	device clock (DACCLK) when the DAC PLL is off. AC couple this input. There is an internal 100 $\Omega$ resistor between this pin and CLKIN-.
K1	CLKOUT+	Negative Device Clock Input. Positive Device Clock Output. This pin is the clock output of a divided down DACCLK and is available with the DAC PLL on and off. The divide down ratios are by 1, 2, or 4.
L1	CLKOUT-	Negative Device Clock Output.
System Reference		
H1	SYSREF+	Positive System Reference Input. It is recommended to ac couple this pin, but dc coupling is also acceptable. See the SYSREF $\pm$ specifications for the dc common-mode voltage.
H2	SYSREF-	Negative System Reference Input. It is recommended to ac couple this pin, but dc coupling is also acceptable. See the SYSREF $\pm$ specifications for the dc common-mode voltage.
On-Chip DAC PLL Loop Filter		
H6	FILT_FINE	On-Chip DAC Clock Multiplier and PLL Fine Loop Filter Input.
H7	FILT_COARSE	On-Chip DAC Clock Multiplier and PLL Coarse Loop Filter Input.
J7	FILT_BYP	On-Chip DAC Clock Multiplier and LDO Bypass.
K6	FILT_VCM	On-Chip DAC Clock Multiplier and VCO Common-Mode Input.
SERDES Data Bits		
A2	SERDIN7+	SERDES Data Bit 7, Positive.
B2	SERDIN7-	SERDES Data Bit 7, Negative.
A3	SERDIN6+	SERDES Data Bit 6, Positive.
B3	SERDIN6-	SERDES Data Bit 6, Negative.
A4	SERDIN5+	SERDES Data Bit 5, Positive.
B4	SERDIN5-	SERDES Data Bit 5, Negative.
A5	SERDIN4+	SERDES Data Bit 4, Positive.
B5	SERDIN4-	SERDES Data Bit 4, Negative.
A8	SERDIN3+	SERDES Data Bit 3, Positive.
B8	SERDIN3-	SERDES Data Bit 3, Negative.
A9	SERDIN2+	SERDES Data Bit 2, Positive.
B9	SERDIN2-	SERDES Data Bit 2, Negative.
A10	SERDIN1+	SERDES Data Bit 1, Positive.
B10	SERDIN1-	SERDES Data Bit 1, Negative.
A11	SERDIN0+	SERDES Data Bit 0, Positive.
B11	SERDIN0-	SERDES Data Bit 0, Negative.
Sync Output		
D12	$\overline{\text{SYNCOUT0+}}$	Positive Sync (Active Low) Output Signal, Channel Link 0. This pin is LVDS or CMOS selectable.
D11	$\overline{\text{SYNCOUT0-}}$	Negative Sync (Active Low) Output Signal, Channel Link 0. This pin is LVDS or CMOS selectable.
D1	$\overline{\text{SYNCOUT1+}}$	Positive Sync (Active Low) Output Signal, Channel Link 1. This pin is LVDS or CMOS selectable.
D2	$\overline{\text{SYNCOUT1-}}$	Negative Sync (Active Low) Output Signal, Channel Link 1. This pin is LVDS or CMOS selectable.
Serial Port Interface		
E4	SDO	Serial Port Data Output (CMOS Levels with Respect to DVDD1.8).
E7	SDIO	Serial Port Data Input/Output (CMOS Levels with Respect to DVDD1.8).
E5	SCLK	Serial Port Clock Input (CMOS Levels with Respect to DVDD1.8).
E6	$\overline{\text{CS}}$	Serial Port Chip Select, Active Low (CMOS Levels with Respect to DVDD1.8).
E8	$\overline{\text{RESET}}$	Reset, Active Low (CMOS Levels with Respect to DVDD1.8).
Interrupt Request		
D9	$\overline{\text{IRQ0}}$	Interrupt Request 0. This pin is an open-drain, active low output (CMOS levels with respect to DVDD1.8). Connect a pull-up resistor to DVDD1.8 to prevent this pin from floating when inactive.
E9	$\overline{\text{IRQ1}}$	Interrupt Request 1. This pin is an open-drain, active low output (CMOS levels with respect to DVDD1.8). Connect a pull-up resistor to DVDD1.8 to prevent this pin from floating when inactive.

## PIN CONFIGURATION AND FUNCTION DESCRIPTIONS

Table 12. Pin Function Descriptions

Pin No.	Mnemonic	Description
CMOS Input/Outputs		
D8	TXEN0	Transmit Enable for DAC0. The CMOS levels are determined with respect to DVDD1.8.
D4	TXEN1	Transmit Enable for DAC1. The CMOS levels are determined with respect to DVDD1.8.
DAC Analog Outputs		
M9	DAC0+	DAC0 Positive Current Output.
M8	DAC0-	DAC0 Negative Current Output.
M4	DAC1+	DAC1 Positive Current Output.
M5	DAC1-	DAC1 Negative Current Output.
Reference		
L12	ISET	Device Bias Current Setting Pin. Connect a 5 k $\Omega$ resistor from this pin to GND, preferably with <0.1% tolerance and < $\pm 25$ ppm/ $^{\circ}$ C temperature coefficient.
Do Not Connect		
E1, E2, E11, E12, J2, K4	DNC	Do Not Connect. Do not connect to these pins.

TYPICAL PERFORMANCE CHARACTERISTICS

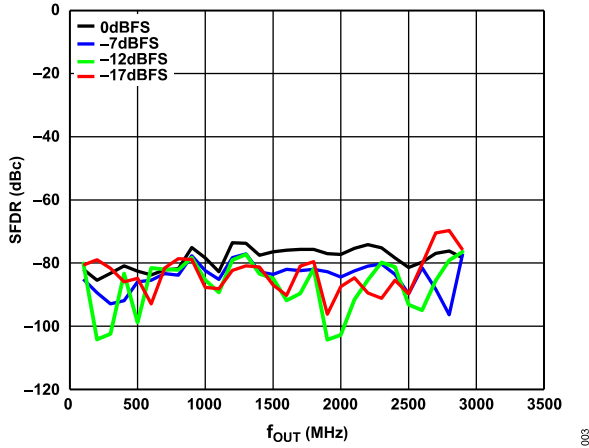

Figure 3. Second Harmonic (SFDR) vs.  $f_{OUT}$  over Digital Scale (Mode 0), 6 GHz DAC Sample Rate, Channel Interpolation 2x, Main Interpolation 8x

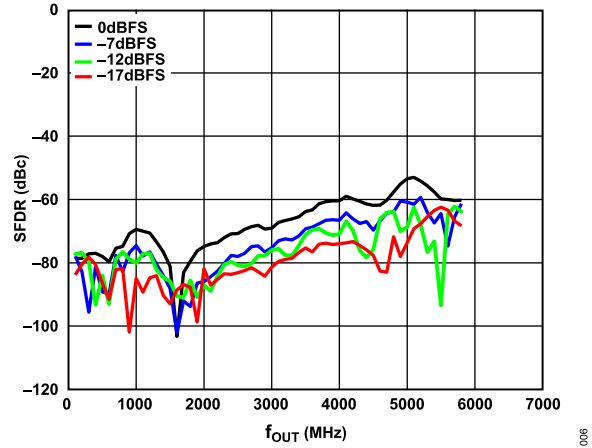

Figure 6. Second Harmonic (SFDR) vs.  $f_{OUT}$  over Digital Scale (Mode 1), 12 GHz DAC Sample Rate, Channel Interpolation 4x, Main Interpolation 8x

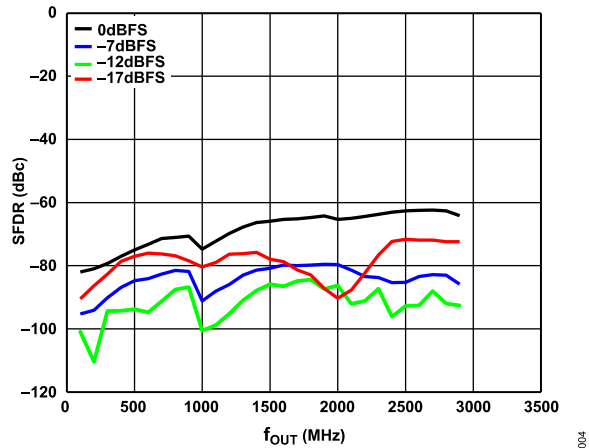

Figure 4. Third Harmonic (SFDR) vs.  $f_{OUT}$  over Digital Scale (Mode 0), 6 GHz DAC Sample Rate, Channel Interpolation 2x, Main Interpolation 8x

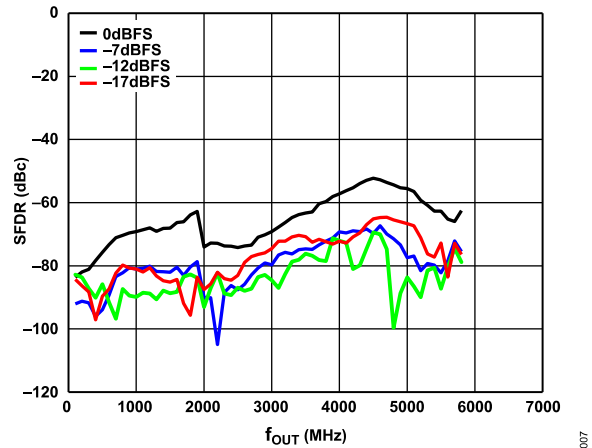

Figure 7. Third Harmonic (SFDR) vs.  $f_{OUT}$  over Digital Scale (Mode 1), 12 GHz DAC Sample Rate, Channel Interpolation 4x, Main Interpolation 8x

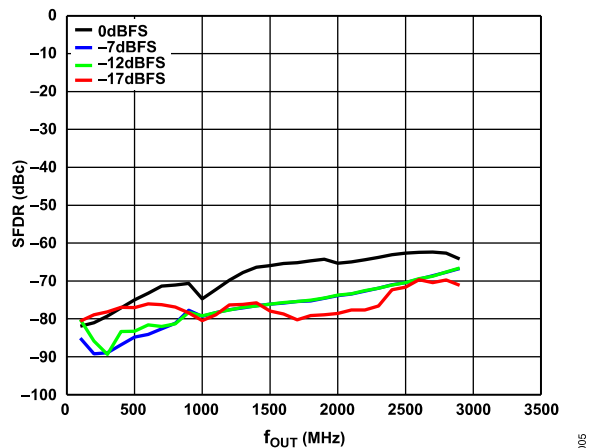

Figure 5. Worst Harmonic (SFDR) vs.  $f_{OUT}$  over Digital Scale (Mode 0), 6 GHz DAC Sample Rate, Channel Interpolation 2x, Main Interpolation 8x

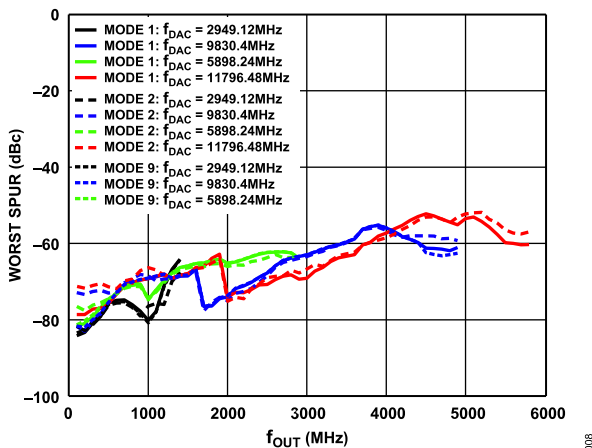

Figure 8. Worst Spur vs.  $f_{OUT}$  over  $f_{DAC}$  (All Modes), 0 dB Digital Scale

TYPICAL PERFORMANCE CHARACTERISTICS

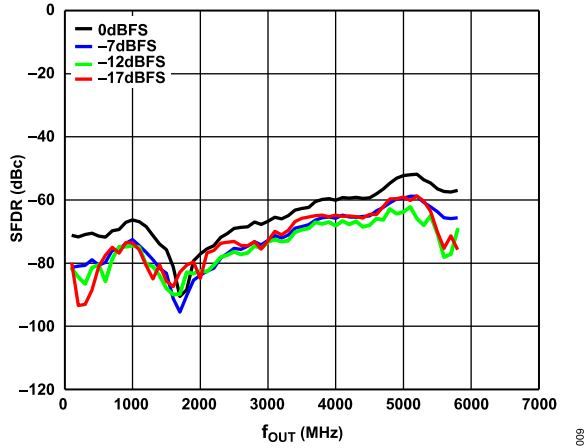

Figure 9. Second Harmonic (SFDR) vs.  $f_{OUT}$  over Digital Scale (Mode 2), 12 GHz DAC Sample Rate, Channel Interpolation 4x, Main Interpolation 8x

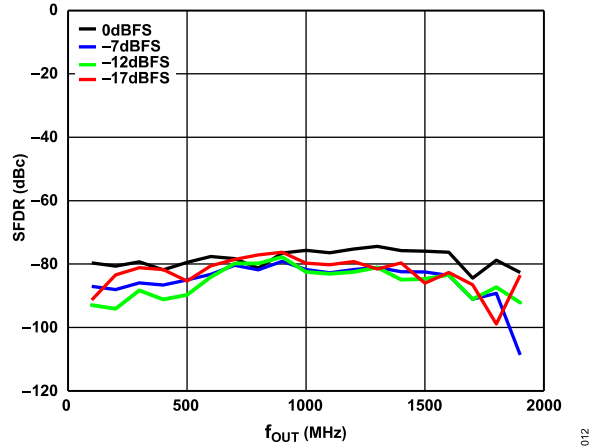

Figure 12. Second Harmonic (SFDR) vs.  $f_{OUT}$  over Digital Scale (Mode 12), 4 GHz DAC Sample Rate, Channel Interpolation 1x, Main Interpolation 1x, 12-Bit Resolution

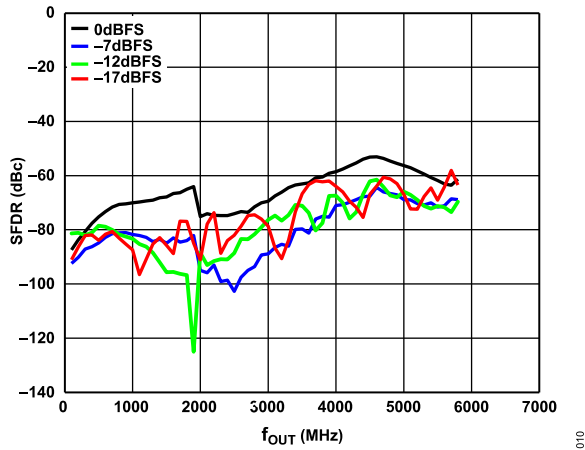

Figure 10. Third Harmonic (SFDR) vs.  $f_{OUT}$  over Digital Scale (Mode 2), 12 GHz DAC Sample Rate, Channel Interpolation 4x, Main Interpolation 8x

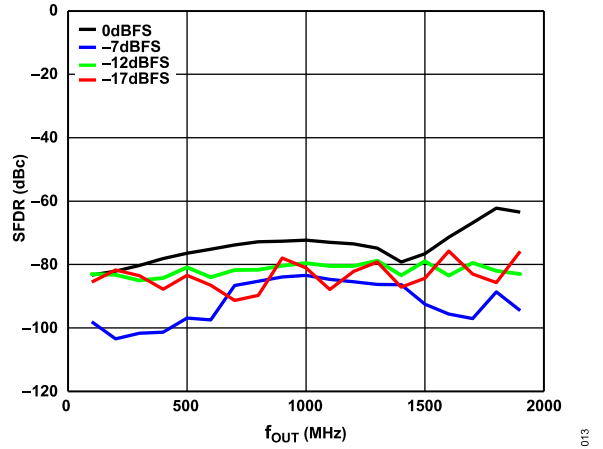

Figure 13. Third Harmonic (SFDR) vs.  $f_{OUT}$  over Digital Scale (Mode 12), 4 GHz DAC Sample Rate, Channel Interpolation 1x, Main Interpolation 1x, 12-Bit Resolution

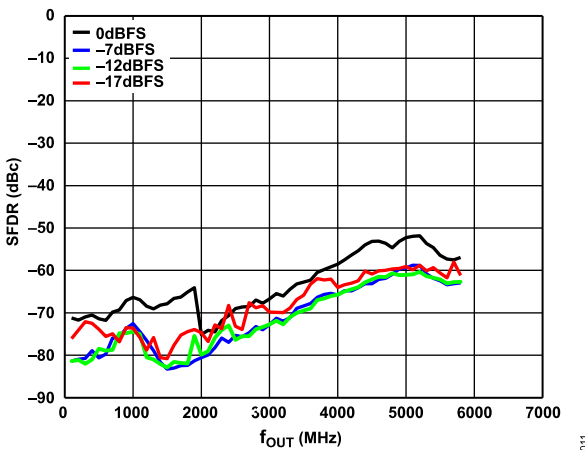

Figure 11. Worst Harmonic (SFDR) vs.  $f_{OUT}$  over Digital Scale (Mode 2), 12 GHz DAC Sample Rate, Channel Interpolation 4x, Main Interpolation 8x

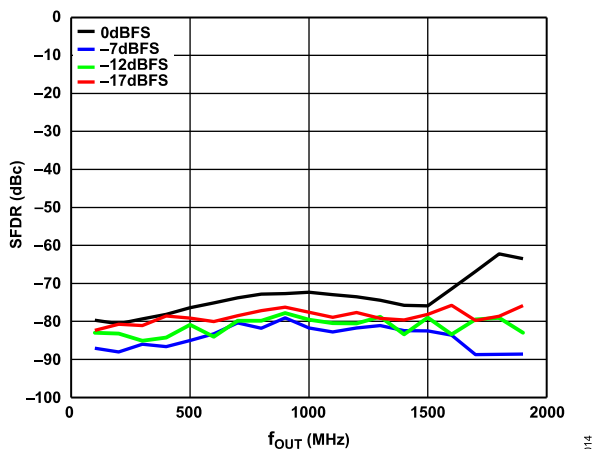

Figure 14. Worst Harmonic (SFDR) vs.  $f_{OUT}$  over Digital Scale (Mode 12), 4 GHz DAC Sample Rate, Channel Interpolation 1x, Main Interpolation 1x, 12-Bit Resolution

TYPICAL PERFORMANCE CHARACTERISTICS

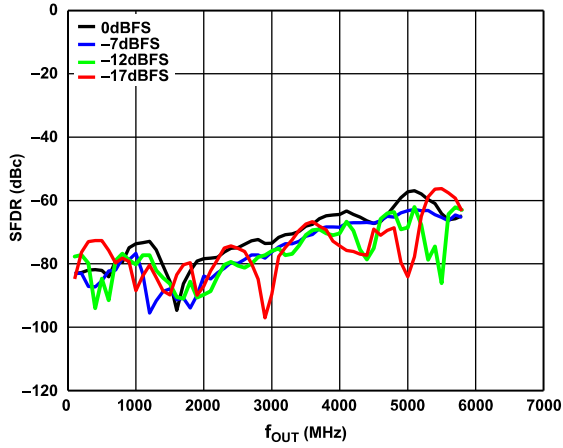

Figure 15. Second Harmonic (SFDR) vs.  $f_{OUT}$  over Digital Scale (Mode 9), 12 GHz DAC Sample Rate, Channel Interpolation 1x, Main Interpolation 8x

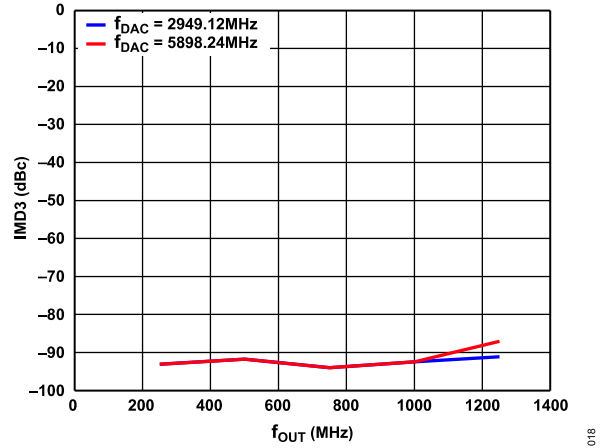

Figure 18. IMD3 vs.  $f_{OUT}$  over  $f_{DAC}$  (Mode 0), Channel Interpolation 2x, Main Interpolation 8x, 1 MHz Tone Spacing

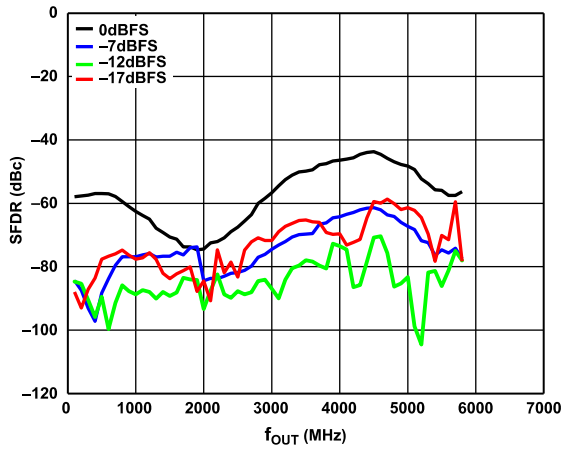

Figure 16. Third Harmonic (SFDR) vs.  $f_{OUT}$  over Digital Scale (Mode 9), 12 GHz DAC Sample Rate, Channel Interpolation 1x, Main Interpolation 8x

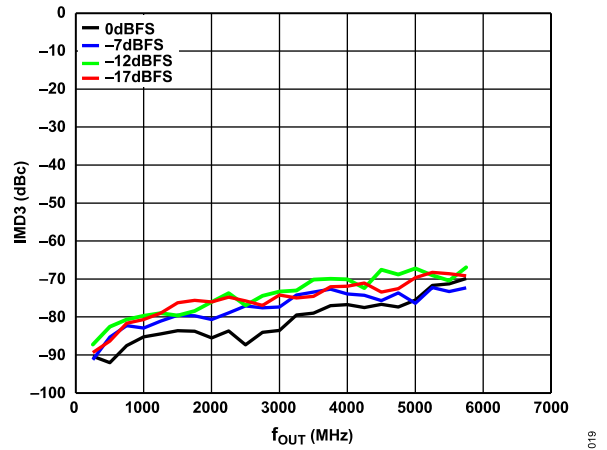

Figure 19. IMD3 vs.  $f_{OUT}$  over Digital Scale (Mode 1), 12 GHz DAC Sample Rate, Channel Interpolation 4x, Main Interpolation 8x, 1 MHz Tone Spacing

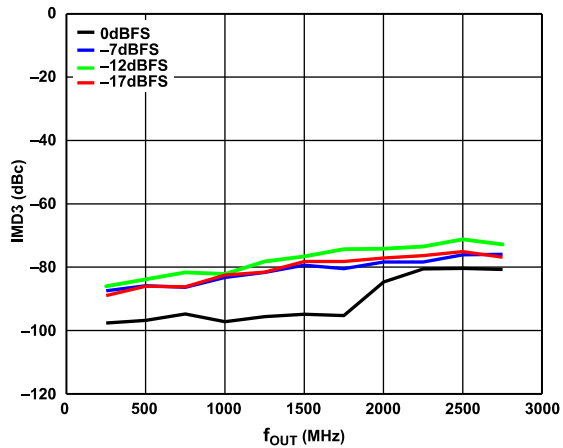

Figure 17. IMD3 vs.  $f_{OUT}$  over Digital Scale (Mode 0) 6 GHz DAC Sample Rate, Channel Interpolation 2x, Main Interpolation 8x, 1 MHz Tone Spacing

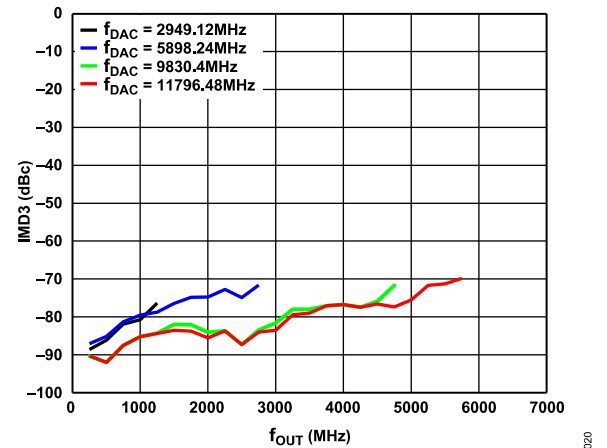

Figure 20. IMD3 vs.  $f_{OUT}$  over  $f_{DAC}$  (Mode 1), Channel Interpolation 4x, Main Interpolation 8x, 1 MHz Tone Spacing, -7 dB Digital Scale

TYPICAL PERFORMANCE CHARACTERISTICS

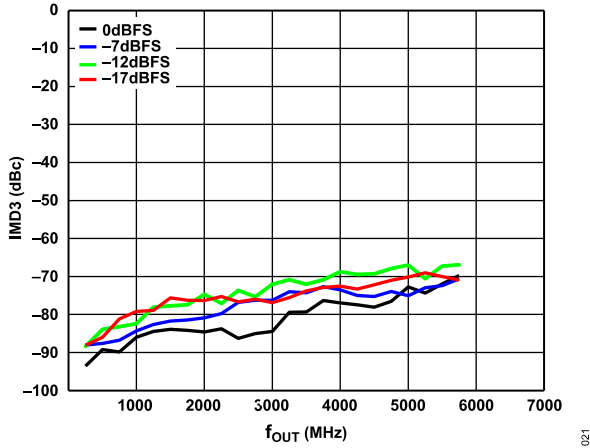

Figure 21. IMD3 vs.  $f_{OUT}$  over Digital Scale (Mode 2), 12 GHz DAC Sample Rate, Channel Interpolation 4x, Main Interpolation 8x, 1 MHz Tone Spacing

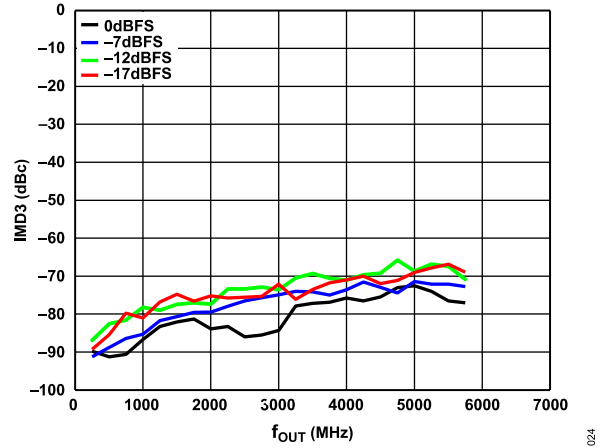

Figure 24. IMD3 vs.  $f_{OUT}$  over Digital Scale (Mode 9), 12 GHz DAC Sample Rate, Channel Interpolation 1x, Main Interpolation 8x, 1 MHz Tone Spacing

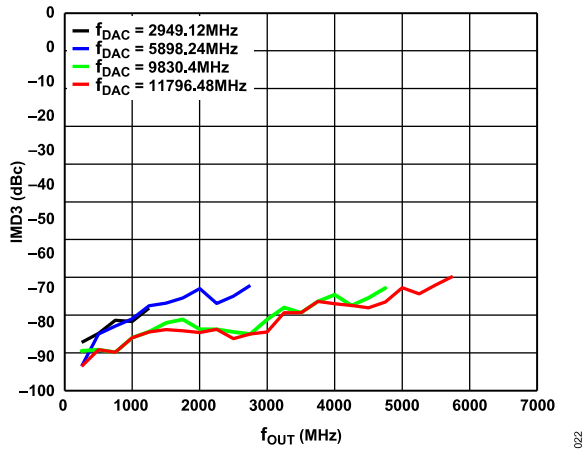

Figure 22. IMD3 vs.  $f_{OUT}$  over  $f_{DAC}$  (Mode 2), Channel Interpolation 4x, Main Interpolation 8x, 1 MHz Tone Spacing

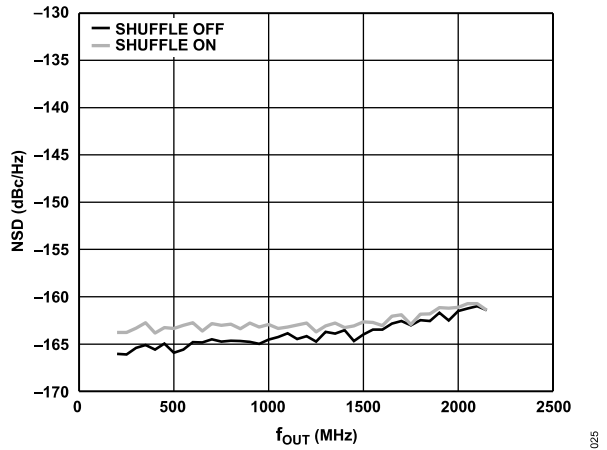

Figure 25. Single-Tone NSD Measured at 70 MHz vs.  $f_{OUT}$ , 11796.48 MHz  $f_{DAC}$ , 16-Bit Resolution, Shuffle Off vs. Shuffle On

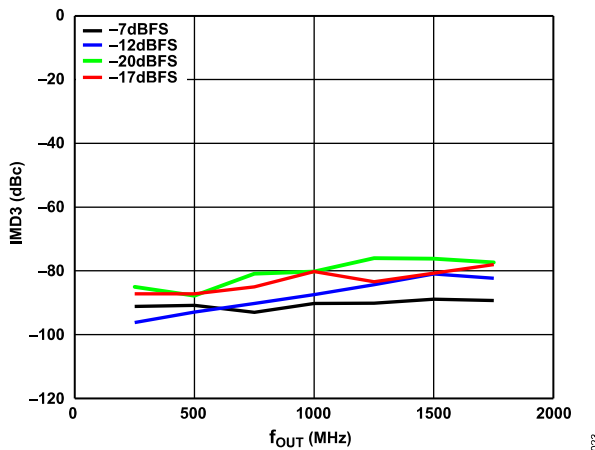

Figure 23. IMD3 vs.  $f_{OUT}$  over Digital Scale (Mode 12), 4 GHz DAC Sample Rate, Channel Interpolation 1x, Main Interpolation 1x, 1 MHz Tone Spacing, 12-Bit Resolution

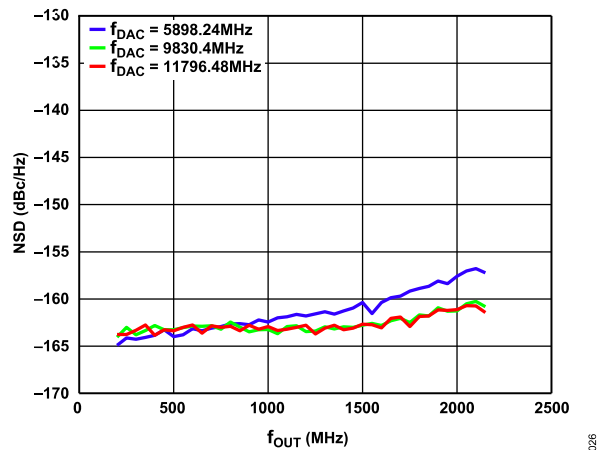

Figure 26. Single-Tone NSD Measured at 70 MHz vs.  $f_{OUT}$  over  $f_{DAC}$ , 16-Bit Resolution, Shuffle On

TYPICAL PERFORMANCE CHARACTERISTICS

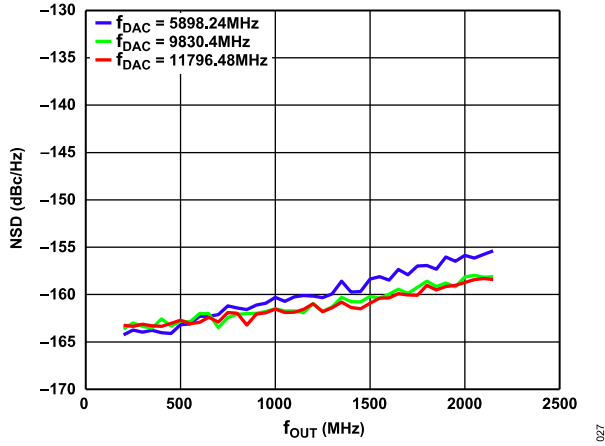

Figure 27. Single-Tone NSD Measured at 10% Offset from  $f_{OUT}$  vs.  $f_{OUT}$  over  $f_{DAC}$ , 16-Bit Resolution, Shuffle On

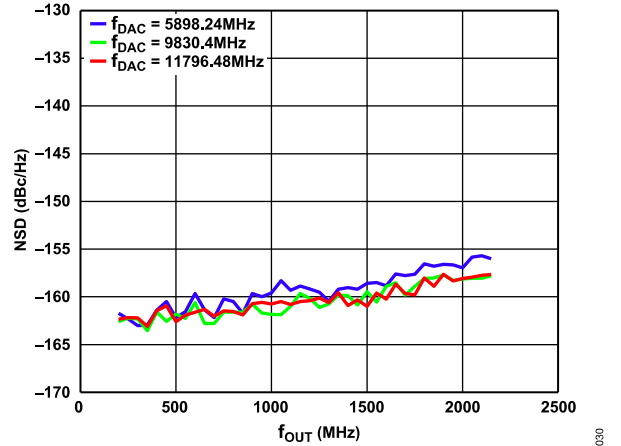

Figure 30. Single-Tone NSD Measured at 10% Offset from  $f_{OUT}$  vs.  $f_{OUT}$  over  $f_{DAC}$ , 12-Bit Resolution, Shuffle On

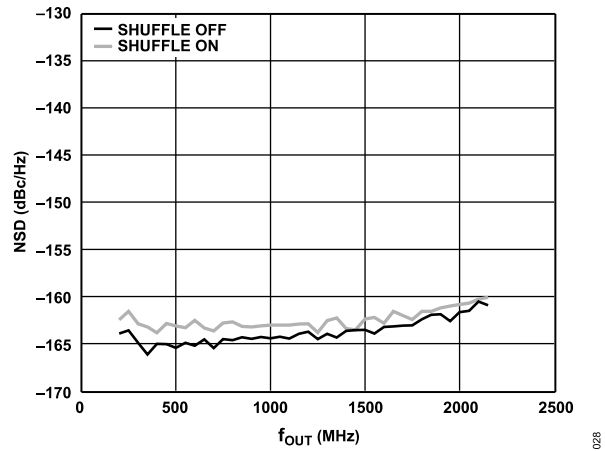

Figure 28. Single-Tone NSD Measured at 70 MHz vs  $f_{OUT}$ , 11796.48 MHz  $f_{DAC}$ , 12-Bit Resolution, Shuffle Off vs. Shuffle On

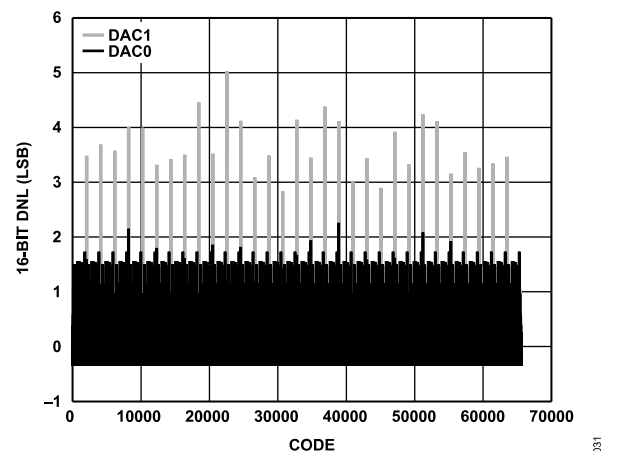

Figure 31. DNL,  $I_{OUTFS} = 26$  mA, 16-Bit Resolution

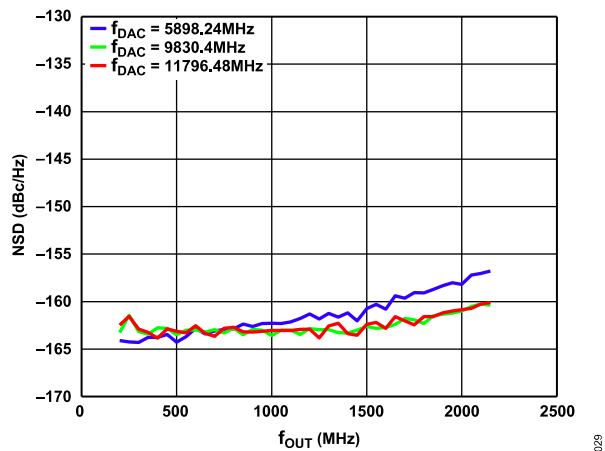

Figure 29. Single-Tone NSD Measured at 70 MHz vs.  $f_{OUT}$  over  $f_{DAC}$ , 12-Bit Resolution, Shuffle On

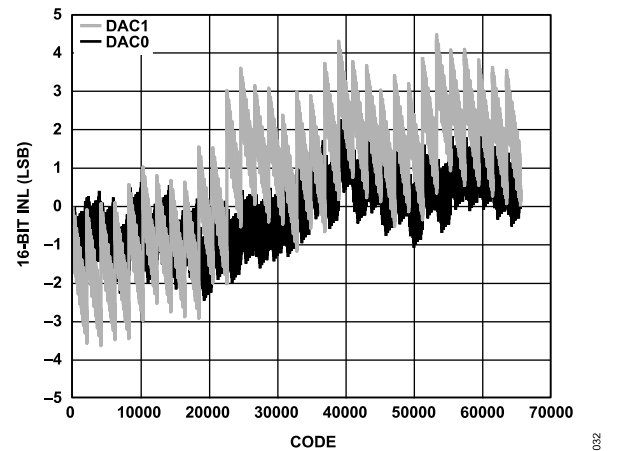

Figure 32. INL,  $I_{OUTFS} = 26$  mA, 16-Bit Resolution

TYPICAL PERFORMANCE CHARACTERISTICS

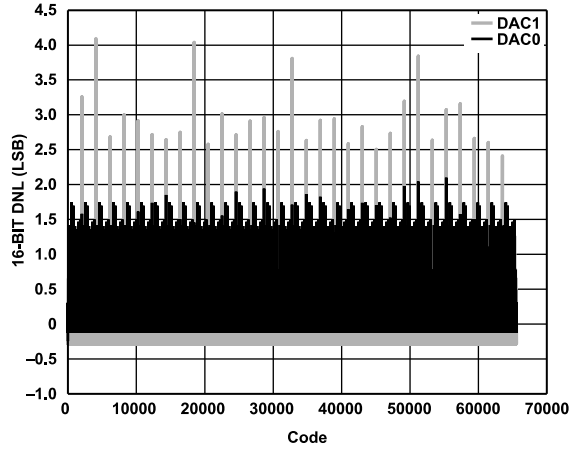

Figure 33. DNL,  $I_{OUTFS} = 20\text{ mA}$ , 16-Bit Resolution

033

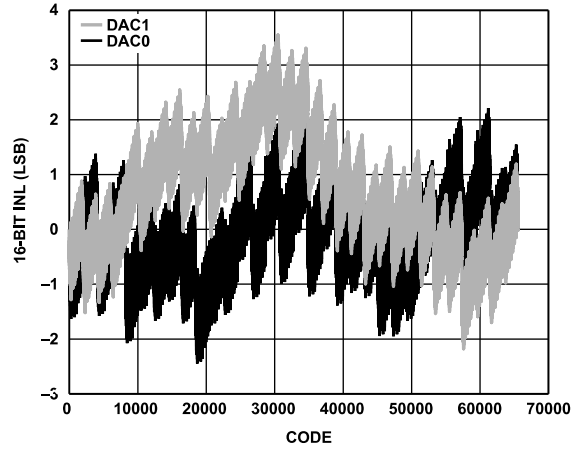

Figure 36. INL,  $I_{OUTFS} = 15.6\text{ mA}$ , 16-Bit Resolution

036

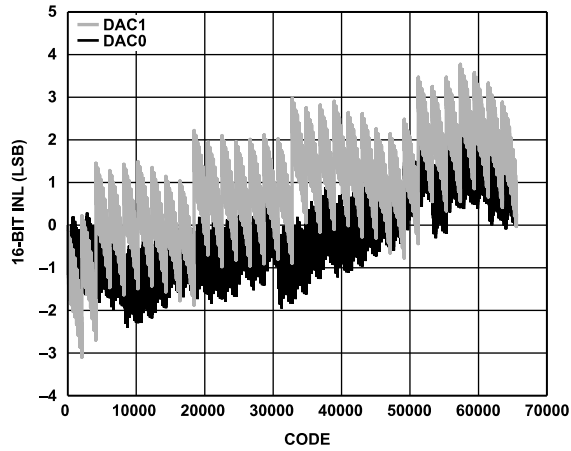

Figure 34. INL,  $I_{OUTFS} = 20\text{ mA}$ , 16-Bit Resolution

034

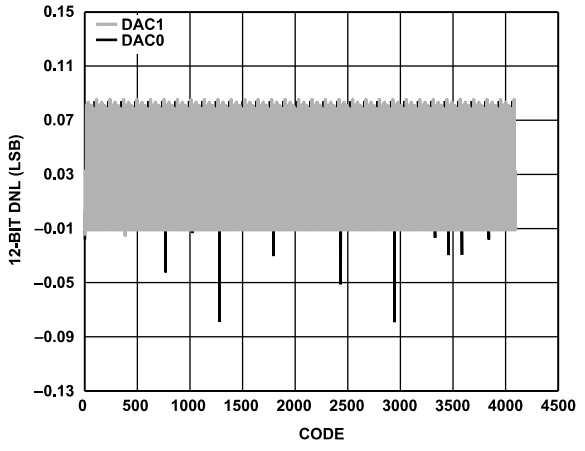

Figure 37. DNL,  $I_{OUTFS} = 20\text{ mA}$ , 12-Bit Resolution

037

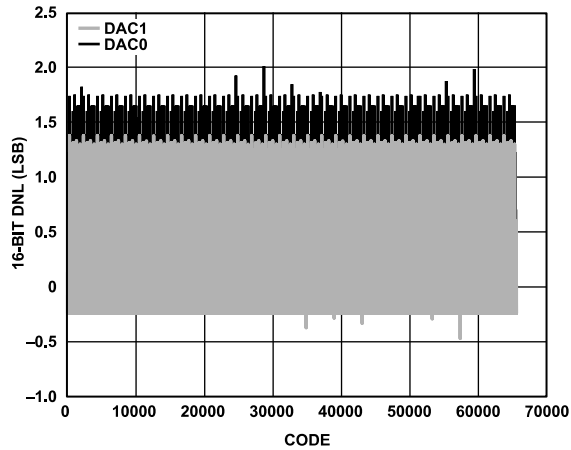

Figure 35. DNL,  $I_{OUTFS} = 15.6\text{ mA}$ , 16-Bit Resolution

035

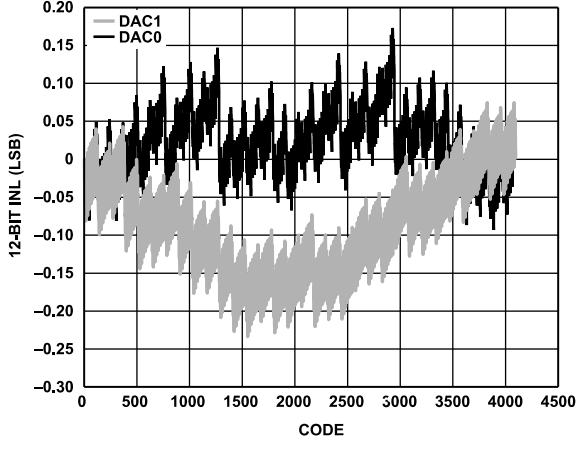

Figure 38. INL,  $I_{OUTFS} = 20\text{ mA}$ , 12-Bit Resolution

038



## TERMINOLOGY

### Integral Nonlinearity INL

INL is the maximum deviation of the actual analog output from the ideal output, determined by a straight line drawn from zero scale to full scale.

### Differential Nonlinearity DNL

DNL is the measure of the variation in analog value, normalized to full scale, associated with a 1 LSB change in digital input code.

### Offset Error

Offset error is the deviation of the output current from the ideal value of 0 mA. For DACx+, a 0 mA output is expected when all inputs are set to 0. For DACx-, a 0 mA output is expected when all inputs are set to 1.

### Gain Error

Gain error is the difference between the actual and ideal output span. The actual span is determined by the difference between the output when the input is at its minimum code and the output when the input is at its maximum code.

### Output Compliance Range

The output compliance range is the range of allowable voltages at the output of a current output DAC. Operation beyond the maximum compliance limits can cause either output stage saturation or breakdown, resulting in nonlinear performance.

### Temperature Drift

Temperature drift is specified as the maximum change from the ambient (25°C) value to the value at either  $T_{MIN}$  or  $T_{MAX}$ . For offset and gain drift, the drift is reported in ppm of full-scale range (FSR) per degree Celsius. For reference drift, the drift is reported in ppm per degree Celsius.

### Settling Time

Settling time is the time required for the output to reach and remain within a specified error band around its final value, measured from the start of the output transition.

### Spurious-Free Dynamic Range SFDR

SFDR is the difference, in decibels, between the peak amplitude of the output signal and the peak spurious signal within the dc to Nyquist frequency of the DAC. Typically, energy in this band is rejected by the interpolation filters. This specification, therefore, defines how well the interpolation filters work and the effect of other parasitic coupling paths on the DAC output.

### Signal-to-Noise Ratio SNR

SNR is the ratio of the rms value of the measured output signal to the rms sum of all other spectral components below the Nyquist frequency, excluding the first six harmonics and dc. The value for SNR is expressed in decibels.

### Interpolation Filter

If the digital inputs to the DAC are sampled at a multiple rate of the interpolation rate ( $f_{DATA}$ ), a digital filter can be constructed that has a sharp transition band near  $f_{DATA}/2$ . Images that typically appear around the output data rate ( $f_{DAC}$ ) can be greatly suppressed.

### Channel Datapath

The channel datapath, sometimes referred to as channelizers, are the complex data channel datapaths, before the summing node in the chip, that can be used or bypassed depending on the mode of operation chosen. When these channelizers are in use, complex data input is required. The channel datapaths include independently controlled optional gain stages and channel NCOs per channel. There is also a selectable channel interpolation block that is configurable (same setting for all channel interpolation blocks) depending on the mode of operation chosen.

### Main Datapath

The main datapath refers to the portion of the digital datapath after the summing node in the chip, up to each of the main DAC analog cores. Each of these main datapaths includes an optional PA protection block with a feed forward to the ramp up/down gain stage block for muting the DAC outputs before damaging a power amplifier in the transmit path. There is a selectable main interpolation block that is configurable (same setting for both main interpolation blocks) depending on the mode of operation chosen. Each main datapath also contains an individually programmable main NCO per main DAC datapath that can be optionally used depending on the mode of operation.

### Adjacent Channel Leakage Ratio (ACLR)

ACLR is the ratio in decibels relative to the carrier (dBc) between the measured power within a channel relative to its adjacent channel.

### Adjusted DAC Update Rate

The adjusted DAC update rate is the DAC update rate divided by the smallest interpolating factor. For clarity on DACs with multiple interpolating factors, the adjusted DAC update rate for each interpolating factor may be given.

### Physical (PHY) Lane

Physical Lane x refers to SERDINx±.

### Logical Lane

Logical Lane x refers to physical lanes after optionally being remapped by the crossbar block (Register 0x308 to Register 0x30B).

### Link Lane

Link Lane x refers to logical lanes considered per link. When paging Link 0 (Register 0x300[2] = 0), Link Lane x = Logical Lane x. When

**TERMINOLOGY**

paging Link 1 (Register 0x300[2] = 1, dual link only), Link Lane x = Logical Lane x + 4.

## THEORY OF OPERATION

The AD9172 is a 16-bit, dual RF DAC with a high speed JESD204B SERDES interface, compliant with Subclass 0 and Subclass 1 operation. [Figure 1](#) shows a functional block diagram of the AD9172. Each DAC core has three individually bypassable channelizers that support up to 1.5 GSPS of complex data rate input per channel. Eight high speed serial lanes carry data at a maximum of 15 Gbps to the channel datapaths. The JESD204B interface supports both single-link and dual-link modes of operation, depending on the selected mode configuration. Compared to either LVDS or CMOS interfaces, the SERDES interface simplifies pin count, board layout, and input clock requirements to the device.

The clock for the input data is derived from the DAC clock, or device clock (required by the JESD204B specification). This device clock can be sourced with a PLL reference clock used by the on-chip PLL to generate a DAC clock, or a high fidelity, direct external DAC sampling clock. The device can be configured to operate in one-, two-, three-, four-, or eight-lane per link modes, depending on the required input data rate.

The digital datapath of the AD9172 offers bypassable (1×) interpolation modes for both the channel datapaths and the main datapaths. Additionally, depending on the selected mode, there are also 2×, 3×, 4×, 6×, and 8× interpolation options for the channel datapaths, and 2×, 4×, 6×, 8×, and 12× interpolation options for the main datapaths. See [Table 13](#) for a summary of the various JESD204B modes available, as well as the respective interpolation options.

For each of the channel digital datapaths (when not using 1× interpolation for the channel), there are individually programmable gain stages and NCO blocks available. The NCO blocks have a 48-bit modulus NCO option to enable digital frequency shifts of signals with near infinite precision. The NCO can operate alone in

NCO only mode using a programmable dc value input via the SPI or with digital data from the SERDES interface and digital datapath. At the end of the three channelizer datapaths, there is a summation node that combines the three channel datapaths together at a maximum of 1.5 GSPS to then pass along to each of the main DAC datapaths for further digital feature options.

Each of the main DAC datapaths contain an optional power amplifier (PA) protection block, a main datapath interpolation block, a main NCO with an optional modulus feature, and a ramp-up/ramp-down gain block that is fed by the PA protection block. Additionally, there is an optional calibration tone feature, as well as four modulator switch modes that are part of the main NCO block.

The AD9172 is capable of multichip synchronization that can both synchronize multiple DACs and establish a constant and deterministic latency (latency locking) path for the DACs. The latency for each of the DACs remains constant to within several DAC clock cycles from link establishment to link establishment. An external alignment signal (SYSREF±) makes the AD9172 JESD204B Subclass 1 compliant. Several modes of SYSREF± signal handling are available for use in the system.

An SPI configures the various functional blocks and monitors their statuses. The various functional blocks and the data interface must be set up in a specific sequence for proper operation (see the [Start-Up Sequence](#) section). Simple SPI initialization routines set up the JESD204B link and are included in the evaluation board package. This data sheet describes the various blocks of the AD9172 in detail. Descriptions of the JESD204B interface, control parameters, and various registers to set up and monitor the device are provided. The recommended start-up routine reliably sets up the data link.

**Table 13. JESD204B Supported Operating Modes and Interpolation Combinations**

Application	JESD204B Operation Modes				Channel Datapath		Main DAC Datapath	
	Link Modes	JESD204B Modes	Lanes per Link	Channels per DAC	Maximum Channel Data Rate (MSPS) <sup>1</sup>	Channel Interpolations	Main Datapath Interpolations	Maximum DAC Rate (GSPS) <sup>2</sup>
Single-Channel, 375 MHz (N = 16 Bits)	Single, dual	0	1	1	385	2×	8×	6.16
						4×, 6×	6×, 8×	12.6
Dual-Channel, 375 MHz (N = 16 Bits)	Single, dual	1	2	2	385	4×, 6×	6×, 8×	12.6
Triple-Channel, 375 MHz (N = 16 Bits)	Single, dual	2	3	3	385	4×, 6×	6×, 8×	12.6
Single Channel, 500 MHz (N = 12 Bits, NP = 12 Bits)	Single, dual	5	1	1	513	2×	6×	6.16
						3×	6×, 8×	12.6
Dual Channel, 500 MHz (N = 12 Bits, NP = 12 Bits)	Single, dual	6	2	2	513	3×	6×, 8×	12.6
Single Channel, 750 MHz (N = 16 Bits)	Single, dual	3	2	1	770	1×	8×	6.16
						2×, 3×	6×, 8×	12.6

## THEORY OF OPERATION

Table 13. JESD204B Supported Operating Modes and Interpolation Combinations

Application	JESD204B Operation Modes			Channel Datapath		Main DAC Datapath		
	Link Modes	JESD204B Modes	Lanes per Link	Channels per DAC	Maximum Channel Data Rate (MSPS) <sup>1</sup>	Channel Interpolations	Main Datapath Interpolations	Maximum DAC Rate (GSPS) <sup>2</sup>
Dual Channel, 750 MHz (N = 16 Bits)	Single, dual	4	4	2	770	2×, 3×	6×, 8×	12.6
Dual Channel, 187 MHz (N = 16 Bits)	Single, dual	7	1	2	385	4×	8×	12.6
Single Channel, 1500 MHz, Dual Tx Cable (N = 16 Bits)	Single, dual	8, 9	4	1	1540	1×	2×, 4×, 6×, 8×, 12×	12.6
Wideband, 3 GHz (N = 16 Bits, NP = 16 Bits)	Single	10, 11	8	1	3080	1×	1×	3.08
Wideband, 4 GHz (N = 12 Bits, NP = 12 Bits)	Single	12	8	1	4100	1×	1×	4.1
3 GHz, Real DAC (N = 16 Bits, NP = 16 Bits)	Single, dual	18, 19	4	1	3080	1×	1×	3.08
6 GHz, Real DAC (N = 16 Bits, NP = 16 Bits)	Single	20, 21	8	1	6160	1×	1×	6.16

<sup>1</sup> The maximum data rate is calculated based on a maximum lane rate as listed in Table 7. The data rate is calculated based on the formula lane rate = (10/8) × NP × data rate × (M/L), where the NP, M, and L values depend on the selected mode.

<sup>2</sup> The maximum DAC rate per mode depends on the voltage tolerance as well as the lane rate for a given configuration, as listed in Table 3. The maximum possible lane rate is according to Table 7.

## SERIAL PORT OPERATION

The serial port is a flexible, synchronous serial communications port that allows easy interfacing with many industry-standard microcontrollers and microprocessors. The serial input/output is compatible with most synchronous transfer formats, including both the Motorola, Inc., SPI and Intel® SSR protocols. The interface allows read and write access to all registers that configure the AD9172. MSB first or LSB first transfer formats are supported. The serial port interface can be configured as a 4-wire interface or a 3-wire interface in which the input and output share a single pin input/output (SDIO).

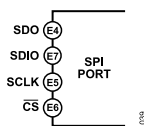

Figure 39. Serial Port Interface Pins (144-Ball BGA\_ED)

There are two phases to a communication cycle with the AD9172. Phase 1 is the instruction cycle (the writing of an instruction byte into the device), coincident with the first 16 SCLK rising edges. The instruction word provides the serial port controller with information regarding the data transfer cycle, Phase 2 of the communication cycle. The Phase 1 instruction word defines whether the upcoming data transfer is a read or write, along with the starting register address for the following data transfer.

A logic high on the  $\overline{CS}$  pin followed by a logic low resets the serial port timing to the initial state of the instruction cycle. From this state, the next 16 rising SCLK edges represent the instruction bits of the current input/output operation.

The remaining SCLK edges are for Phase 2 of the communication cycle. Phase 2 is the actual data transfer between the device and the system controller. Phase 2 of the communication cycle is a transfer of one or more data bytes. Eight  $\times$  N SCLK cycles are required to transfer N bytes during the transfer cycle. Registers change immediately upon writing to the last bit of each transfer byte, except for the FTW and NCO phase offsets, which change only when the frequency tuning word load request bit (DDSM\_FT\_W\_LOAD\_REQ or DDSC\_FT\_W\_LOAD\_REQ) is set.

### DATA FORMAT

The instruction byte contains the information shown in Table 14.

Table 14. Serial Port Instruction Word

I15 (MSB)	I[14:0]
R/W	A[14:0]

R/W, Bit 15 of the instruction word, determines whether a read or a write data transfer occurs after the instruction word write. Logic 1 indicates a read operation, and Logic 0 indicates a write operation.

A14 to A0, Bit 14 to Bit 10 of the instruction word, determine the register that is accessed during the data transfer portion of the communication cycle. For multibyte transfers, A[14:0] is the starting address. The remaining register addresses are generated by the device based on the address increment bit. If the address

increment bits are set high (Register 0x000, Bit 5 and Bit 2), multibyte SPI writes start on A[14:0] and increment by 1 every eight bits sent/received. If the address increment bits are set to 0, the address decrements by 1 every eight bits.

## SERIAL PORT PIN DESCRIPTIONS

### Serial Clock (SCLK)

The serial clock pin synchronizes data to and from the device and runs the internal state machines. The maximum frequency of SCLK is 80 MHz. All data input is registered on the rising edge of SCLK. All data is driven out on the falling edge of SCLK.

### Chip Select ( $\overline{CS}$ )

An active low input starts and gates a communication cycle.  $\overline{CS}$  allows more than one device to be used on the same serial communications lines. The SDIO pin goes to a high impedance state when this input is high. During the communication cycle, the chip select must stay low.

### Serial Data Input/Output (SDIO)

This pin is a bidirectional data line. In 4-wire mode, this pin acts as the data input and SDO acts as the data output.

## SERIAL PORT OPTIONS

The serial port can support both MSB first and LSB first data formats. This functionality is controlled by the LSB first bit (Register 0x000, Bit 6 and Bit 1). The default is MSB first (LSBFIRST bit = 0).

When the LSB first bits = 0 (MSB first), the instruction and data bits must be written from MSB to LSB. R/W is followed by A[14:0] as the instruction word, and D[7:0] is the data-word. When the LSB first bits = 1 (LSB first), the opposite is true. A[0:14] is followed by R/W, which is subsequently followed by D[0:7].

The serial port supports a 3-wire or 4-wire interface. When the SDO active bits = 1 (Register 0x000, Bit 4 and Bit 3), a 4-wire interface with a separate input pin (SDIO) and output pin (SDO) is used. When the SDO active bits = 0, the SDO pin is unused and the SDIO pin is used for both the input and the output.

Multibyte data transfers can be performed as well by holding the  $\overline{CS}$  pin low for multiple data transfer cycles (eight SCLKs) after the first data transfer word following the instruction cycle. The first eight SCLKs following the instruction cycle read from or write to the register provided in the instruction cycle. For each additional eight SCLK cycles, the address is either incremented or decremented and the read/write occurs on the new register. The direction of the address can be set using ADDRINC or ADDRINC\_M (Register 0x000, Bit 5 and Bit 2). When ADDRINC or ADDRINC\_M is 1, the multicycle addresses are incremented. When ADDRINC or ADDRINC\_M is 0, the addresses are decremented. A new write cycle can always be initiated by bringing  $\overline{CS}$  high and then low again.

**SERIAL PORT OPERATION**

To prevent confusion and to ensure consistency between devices, the chip tests the first nibble following the address phase, ignoring the second nibble. This test is completed independently from the

LSB first bits and ensures that there are extra clock cycles following the soft reset bits (Register 0x000, Bit 0 and Bit 7). This test of the first nibble only applies when writing to Register 0x000.

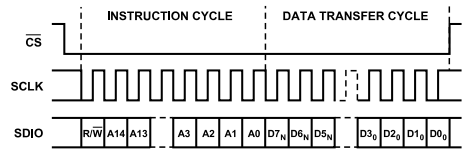

Figure 40. Serial Register Interface Timing, MSB First, Register 0x000, Bit 6 and Bit 1 = 0

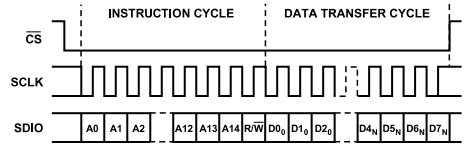

Figure 41. Serial Register Interface Timing, LSB First, Register 0x000, Bit 6 and Bit 1 = 1

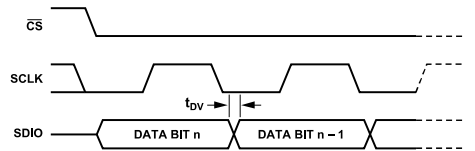

Figure 42. Timing Diagram for Serial Port Register Read

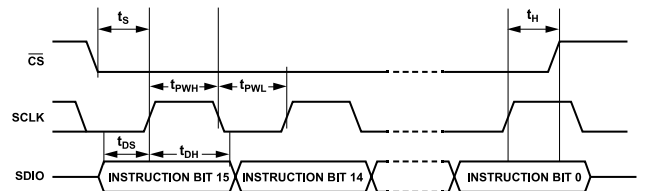

Figure 43. Timing Diagram for Serial Port Register Write

## JESD204B SERIAL DATA INTERFACE

### JESD204B OVERVIEW

The AD9172 has eight JESD204B data ports that receive data. The eight JESD204B ports can be configured as part of a single or dual JESD204B link that uses a single system reference (SYSREF $\pm$ ) and device clock (CLKIN $\pm$ ).

The JESD204B serial interface hardware consists of three layers: the physical layer, the data link layer, and the transport layer. These sections of the hardware are described in subsequent sections, including information for configuring every aspect of the interface. Figure 44 shows the communication layers implemented in the AD9172 serial data interface to recover the clock and deserialize, descramble, and deframe the data before it is sent to each of the digital signal processing channelizers of the device.

The physical layer establishes a reliable channel between the transmitter (Tx) and the receiver (Rx), and the data link layer is responsible for unpacking the data into octets and descrambling the data. The transport layer receives the descrambled JESD204B frames and converts them to DAC samples.

A number of JESD204B parameters (L, F, K, M, N, NP, S, HD) define how the data is packed and tell the device how to turn the serial data into samples. These parameters are defined in detail in the [Transport Layer](#) section. The AD9172 also has a descrambling option (see the [Descrambler](#) section for more information). The AD9172 has the ability to use 12-bit packing mode (NP = 12, N = 11 or 12) to increase the maximum data rate achievable by this device for applications that do not require 16-bit resolution capabilities.

The AD9172 has multiple single-link and dual-link mode options available for various application purposes. These modes and their respective JESD204B link parameters are described in [Table 15](#) and [Table 16](#). There are different interpolation combinations available for the channel and main datapaths, as well as whether single-link and dual-link options are available depending on which JESD204B mode is chosen. [Table 13](#) lists the possible link and interpolation combinations available.

The AD9172 has two DAC outputs; however, for the purposes of complex signal processing on chip, the converter count, represented by the M JESD204B parameter, reflects the number of complex subchannels of data required per link when using a total interpolation greater than 1 $\times$ . The number of complex subchannels of data per link required to be sent to the device also depends on the number of channelizers being used, based on the mode of operation chosen. If the channelizer datapaths are bypassed (channel interpolation is set to 1 $\times$ ) and the main datapath interpolation is set to 1 $\times$ , the converter count (M) reflects the number of real converters per link being used in the mode of operation; in this case, complex data is not required.

For a particular JESD204B mode of operation, the following relationships exist:

$$\text{Total Interpolation} = \text{Channel Interpolation} \times \text{Main Interpolation}$$

$$\text{Data Rate} = \text{DAC Rate} / \text{Total Interpolation}$$

$$\text{Lane Rate} = (M/L) \times NP \times (10/8) \times \text{Data Rate}$$

where:

*Lane Rate* must be between 3 Gbps and 15 Gbps.

M, L, and NP are JESD204B link parameters for the chosen JESD204B operating mode.

Achieving and recovering synchronization of the lanes is important. To simplify the interface to the transmitter, the AD9172 designates a master synchronization signal for each JESD204B link. The SYNCOUT0 $\pm$  and SYNCOUT1 $\pm$  pins are used as the master signal for all lanes on each link. If any lane in a link loses synchronization, a resynchronization request is sent to the transmitter via the synchronization signal of the link. The transmitter stops sending data and instead sends synchronization characters to all lanes in that link until resynchronization is achieved.

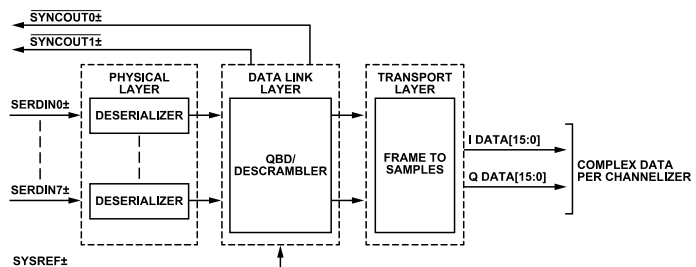

Figure 44. Functional Block Diagram of Serial Link Receiver



JESD204B SERIAL DATA INTERFACE

Table 15. Single-Link JESD204B Operating Modes

Parameter	Single-Link JESD204B Modes																
	0	1	2	3	4	5	6	7	8	9	10	11	12	18	19	20	21
L (Lane Count)	1	2	3	2	4	1	2	1	4	4	8	8	8	4	4	8	8
M (Converter Count)	2	4	6	2	4	2	4	4	2	2	2	2	2	1	1	1	1
F (Octets per Frame per Lane)	4	4	4	2	2	3	3	8	1	2	1	2	3	1	2	1	2
S (Samples per Converter per Frame)	1	1	1	1	1	1	1	1	1	2	2	4	8	2	4	4	8
NP (Total Number of Bits per Sample)	16	16	16	16	16	12	12	16	16	16	16	16	12	16	16	16	16
N (Converter Resolution)	16	16	16	16	16	12	12	16	16	16	16	16	12	16	16	16	16
K (Frames per Multiframe)	32	32	32	32	32	32	32	32	32	32	32	32	32	32	32	32	32
HD (High Density User Data Format)	1	1	1	1	1	1	1	1	1	1	1	1	1	1	1	1	1

Table 16. Dual-Link JESD204B Operating Modes

Parameter	Dual-Link JESD204B Modes													
	0	1	2	3	4	5	6	7	8	9	18	19		
L (Lane Count)	1	2	3	2	4	1	2	1	4	4	4	4	4	
M (Converter Count)	2	4	6	2	4	2	4	4	2	2	1	1	1	
F (Octets per Frame per Lane)	4	4	4	2	2	3	3	8	1	2	1	2	2	
S (Samples per Converter per Frame)	1	1	1	1	1	1	1	1	1	2	2	4	4	
NP (Total Number of Bits per Sample)	16	16	16	16	16	12	12	16	16	16	16	16	16	
N (Converter Resolution)	16	16	16	16	16	12	12	16	16	16	16	16	16	
K (Frames per Multiframe)	32	32	32	32	32	32	32	32	32	32	32	32	32	
HD (High Density User Data Format)	1	1	1	1	1	1	1	1	1	1	1	1	1	

Table 17. Data Structure per Lane for F = 1 JESD204B Operating Modes<sup>1</sup>

JESD204B Mode and Parameters	Link Logical Lane	Frame 0, Octet 0	Frame 1, Octet 0
L = 4, M = 4, S = 1, NP = 16, N = 16 Mode 8: N = 16 Mode 13: N = 11 <sup>2</sup>	Lane 0	MOS0[15:8]	MOS1[15:8]
	Lane 1	MOS0[7:0]	MOS1[7:0]
	Lane 2	M1S0[15:8]	M1S1[15:8]
	Lane 3	M1S0[7:0]	M1S1[7:0]
Mode 10 (L = 8, M = 2, S = 2, NP = 16, N = 16)	Lane 0	MOS0[15:8]	MOS2[15:8]
	Lane 1	MOS0[7:0]	MOS2[7:0]
	Lane 2	MOS1[15:8]	MOS3[15:8]
	Lane 3	MOS1[7:0]	MOS3[7:0]
	Lane 4	M1S0[15:8]	M1S2[15:8]
	Lane 5	M1S0[7:0]	M1S2[7:0]
	Lane 6	M1S1[15:8]	M1S3[15:8]
	Lane 7	M1S1[7:0]	M1S3[7:0]
Mode 18 (L = 4, M = 1, S = 2, NP = 16, N = 16)	Lane 0	MOS0[15:8]	MOS2[15:8]
	Lane 1	MOS0[7:0]	MOS2[7:0]
	Lane 2	MOS1[15:8]	MOS3[15:8]
	Lane 3	MOS1[7:0]	MOS3[7:0]
Mode 20 (L = 8, M = 1, S = 4, NP = 16, N = 16)	Lane 0	MOS0[15:8]	MOS4[15:8]
	Lane 1	MOS0[7:0]	MOS4[7:0]
	Lane 2	MOS1[15:8]	MOS5[15:8]
	Lane 3	MOS1[7:0]	MOS5[7:0]
	Lane 4	MOS2[15:8]	MOS6[15:8]
	Lane 5	MOS2[7:0]	MOS6[7:0]
	Lane 6	MOS3[15:8]	MOS7[15:8]



## JESD204B SERIAL DATA INTERFACE

Table 17. Data Structure per Lane for F = 1 JESD204B Operating Modes<sup>1</sup>

JESD204B Mode and Parameters	Link Logical Lane	Frame 0, Octet 0	Frame 1, Octet 0
		Lane 7	MOS3[7:0]

<sup>1</sup> Mx is the converter number and Sy is the sample number. For example, MOS0 means Converter 0, Sample 0.

<sup>2</sup> Generate 11 bit resolution data and set Bits[4:0] to 0 for the full 16-bit data packing (NP).

Table 18. Data Structure per Lane for F = 2 JESD204B Operating Modes<sup>1</sup>

JESD204B Mode and Parameters	Link Logical Lane	Frame 0		Frame 1	
		Octet 0	Octet 1	Octet 0	Octet 2
Mode 3 (L = 2, M = 2, S = 1, NP = 16, N = 16)	Lane 0	MOS0[15:8]	MOS0[7:0]	MOS1[15:8]	MOS1[7:0]
	Lane 1	M1S0[15:8]	M1S0[7:0]	M1S1[15:8]	M1S1[7:0]
Mode 4 (L = 4, M = 4, S = 1, NP = 16, N = 16)	Lane 0	MOS0[15:8]	MOS0[7:0]	MOS1[15:8]	MOS1[7:0]
	Lane 1	M1S0[15:8]	M1S0[7:0]	M1S1[15:8]	M1S1[7:0]
	Lane 2	M2S0[15:8]	M2S0[7:0]	M2S1[15:8]	M2S1[7:0]
	Lane 3	M3S0[15:8]	M3S0[7:0]	M3S1[15:8]	M3S1[7:0]
Mode 9 (L = 4, M = 2, S = 2, NP = 16, N = 16)	Lane 0	MOS0[15:8]	MOS0[7:0]	MOS2[15:8]	MOS2[7:0]
	Lane 1	MOS1[15:8]	MOS1[7:0]	MOS3[15:8]	MOS3[7:0]
	Lane 2	M1S0[15:8]	M1S0[7:0]	M1S2[15:8]	M1S2[7:0]
	Lane 3	M1S1[15:8]	M1S1[7:0]	M1S3[15:8]	M1S3[7:0]
Mode 11 (L = 8, M = 2, S = 4, NP = 16, N = 16)	Lane 0	MOS0[15:8]	MOS0[7:0]	MOS4[15:8]	MOS4[7:0]
	Lane 1	MOS1[15:8]	MOS1[7:0]	MOS5[15:8]	MOS5[7:0]
	Lane 2	MOS2[15:8]	MOS2[7:0]	MOS6[15:8]	MOS6[7:0]
	Lane 3	MOS3[15:8]	MOS3[7:0]	MOS7[15:8]	MOS7[7:0]
	Lane 4	M1S0[15:8]	M1S0[7:0]	M1S4[15:8]	M1S4[7:0]
	Lane 5	M1S1[15:8]	M1S1[7:0]	M1S5[15:8]	M1S5[7:0]
	Lane 6	M1S2[15:8]	M1S2[7:0]	M1S6[15:8]	M1S6[7:0]
	Lane 7	M1S3[15:8]	M1S3[7:0]	M1S7[15:8]	M1S7[7:0]
Mode 19 (L = 4, M = 1, S = 4, NP = 16, N = 16)	Lane 0	MOS0[15:8]	MOS0[7:0]	MOS4[15:8]	MOS4[7:0]
	Lane 1	MOS1[15:8]	MOS1[7:0]	MOS5[15:8]	MOS5[7:0]
	Lane 2	MOS2[15:8]	MOS2[7:0]	MOS6[15:8]	MOS6[7:0]
	Lane 3	MOS3[15:8]	MOS3[7:0]	MOS7[15:8]	MOS7[7:0]
Mode 21 (L = 8, M = 1, S = 8, NP = 16, N = 16)	Lane 0	MOS0[15:8]	MOS0[7:0]	MOS8[15:8]	MOS8[7:0]
	Lane 1	MOS1[15:8]	MOS1[7:0]	MOS9[15:8]	MOS9[7:0]
	Lane 2	MOS2[15:8]	MOS2[7:0]	MOS10[15:8]	MOS10[7:0]
	Lane 3	MOS3[15:8]	MOS3[7:0]	MOS11[15:8]	MOS11[7:0]
	Lane 4	MOS4[15:8]	MOS4[7:0]	MOS12[15:8]	MOS12[7:0]
	Lane 5	MOS5[15:8]	MOS5[7:0]	MOS13[15:8]	MOS13[7:0]
	Lane 6	MOS6[15:8]	MOS6[7:0]	MOS14[15:8]	MOS14[7:0]
	Lane 7	MOS7[15:8]	MOS7[7:0]	MOS15[15:8]	MOS15[7:0]

<sup>1</sup> Mx is the converter number and Sy is the sample number. For example, MOS0 means Converter 0, Sample 0.

## JESD204B SERIAL DATA INTERFACE

Table 19. Data Structure per Lane for F = 3 JESD204B Operating Modes<sup>1</sup>

JESD204B Mode and Parameters	Link Logical Lane	Frame 0					
		Octet 0		Octet 1		Octet 2	
		Nibble 0	Nibble1	Nibble 0	Nibble1	Nibble 0	Nibble1
Mode 5 (L = 1, M = 2, S = 1, NP = 12, N = 12)	Lane 0	M0S0[11:8]	M0S0[7:4]	M0S0[3:0]	M1S0[11:8]	M1S0[7:4]	M1S0[3:0]
Mode 6 (L = 2, M = 4, S = 1, NP = 12, N = 12)	Lane 0	M0S0[11:8]	M0S0[7:4]	M0S0[3:0]	M1S0[11:8]	M1S0[7:4]	M1S0[3:0]
	Lane 1	M2S0[11:8]	M2S0[7:4]	M2S0[3:0]	M3S0[11:8]	M3S0[7:4]	M3S0[3:0]
Mode 12 (L = 8, M = 2, S = 8, NP = 12, N = 12)	Lane 0	M0S0[11:8]	M0S0[7:4]	M0S0[3:0]	M0S1[11:8]	M0S1[7:4]	M0S1[3:0]
	Lane 1	M0S2[11:8]	M0S2[7:4]	M0S2[3:0]	M0S3[11:8]	M0S3[7:4]	M0S3[3:0]
	Lane 2	M0S4[11:8]	M0S4[7:4]	M0S4[3:0]	M0S5[11:8]	M0S5[7:4]	M0S5[3:0]
	Lane 3	M0S6[11:8]	M0S6[7:4]	M0S6[3:0]	M0S7[11:8]	M0S7[7:4]	M0S7[3:0]
	Lane 4	M1S0[11:8]	M1S0[7:4]	M1S0[3:0]	M1S1[11:8]	M1S1[7:4]	M1S1[3:0]
	Lane 5	M1S2[11:8]	M1S2[7:4]	M1S2[3:0]	M1S3[11:8]	M1S3[7:4]	M1S3[3:0]
	Lane 6	M1S4[11:8]	M1S4[7:4]	M1S4[3:0]	M1S5[11:8]	M1S5[7:4]	M1S5[3:0]
Lane 7	M1S6[11:8]	M1S6[7:4]	M1S6[3:0]	M1S7[11:8]	M1S7[7:4]	M1S7[3:0]	

<sup>1</sup> Mx is the converter number and Sy is the sample number. For example, M0S0 means Converter 0, Sample 0.

Table 20. Data Structure per Lane for F = 4 JESD204B Operating Modes<sup>1</sup>

JESD204B Mode and Parameters	Link Logical Lane	Frame 0				Frame 1			
		Octet 0	Octet 1	Octet 2	Octet 3	Octet 0	Octet 1	Octet 2	Octet 3
Mode 0 (L = 1, M = 2, S = 1, NP = 16, N = 16)	Lane 0	M0S0[15:8]	M0S0[7:0]	M1S0[15:8]	M1S0[7:0]	M0S1[15:8]	M0S1[7:0]	M1S1[15:8]	M1S1[7:0]
Mode 1 (L = 2, M = 4, S = 1, NP = 16, N = 16)	Lane 0	M0S0[15:8]	M0S0[7:0]	M1S0[15:8]	M1S0[7:0]	M0S1[15:8]	M0S1[7:0]	M1S1[15:8]	M1S1[7:0]
	Lane 1	M2S0[15:8]	M2S0[7:0]	M3S0[15:8]	M3S0[7:0]	M2S1[15:8]	M2S1[7:0]	M3S1[15:8]	M3S1[7:0]
Mode 2 (L = 3, M = 6, S = 1, NP = 16, N = 16)	Lane 0	M0S0[15:8]	M0S0[7:0]	M1S0[15:8]	M1S0[7:0]	M0S1[15:8]	M0S1[7:0]	M1S1[15:8]	M1S1[7:0]
	Lane 1	M2S0[15:8]	M2S0[7:0]	M3S0[15:8]	M3S0[7:0]	M2S1[15:8]	M2S1[7:0]	M3S1[15:8]	M3S1[7:0]
	Lane 2	M4S0[15:8]	M4S0[7:0]	M5S0[15:8]	M5S0[7:0]	M4S1[15:8]	M4S1[7:0]	M5S1[15:8]	M5S1[7:0]

<sup>1</sup> Mx is the converter number and Sy is the sample number. For example, M0S0 means Converter 0, Sample 0.

Table 21. Data Structure per Lane for F = 8 JESD204B Operating Modes<sup>1</sup>

JESD204B Mode and Parameters	Link Logical Lane	Frame 0							
		Octet 0	Octet 1	Octet 2	Octet 3	Octet 4	Octet 5	Octet 6	Octet 7
Mode 7 (L = 1, M = 4, S = 1, NP = 16, N = 16)	Lane 0	M0S0[15:8]	M0S0[7:0]	M1S0[15:8]	M1S0[7:0]	M2S0[15:8]	M2S0[7:0]	M3S0[15:8]	M3S0[7:0]

<sup>1</sup> Mx is the converter number and Sy is the sample number. For example, M0S0 means Converter 0, Sample 0.

## JESD204B SERIAL DATA INTERFACE

### PHYSICAL LAYER

The physical layer of the JESD204B interface, hereafter referred to as the deserializer, has eight identical channels. Each channel consists of the termination, an equalizer, a clock and data recovery (CDR) circuit, and the 1:40 demux function (see [Figure 45](#)).

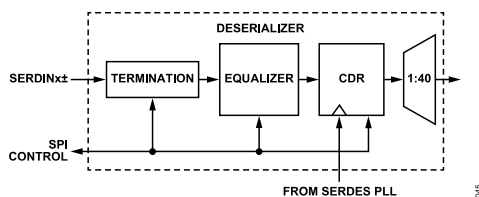

Figure 45. Deserializer Block Diagram

JESD204B data is input to the AD9172 via the SERDINx± differential input pins, per the JESD204B specification.

### Interface Power-Up and Input Termination

Before using the JESD204B interface, it must be powered up by setting Register 0x200, Bit 0 = 0. In addition, each physical lane (PHY) that is not being used (SERDINx±) must be powered down. To do so, set the corresponding Bit x for Physical Lane x in Register 0x201 to 0 if the physical lane is being used, and to 1 if it is not being used.

The AD9172 autocalibrates the input termination to 50 Ω. This calibration routine is performed automatically when the JESD204B interface blocks are configured and does not require any additional SPI register writes.

### Receiver Eye Mask

The AD9172 is compatible with the JESD204B specification regarding the receiver eye mask and is capable of capturing data that complies with the mask in [Figure 46](#). [Figure 46](#) shows the receiver eye normalized to the data rate interval. The AD9172 also supports an increased insertion loss limit, as defined in the [Equalization](#) section.

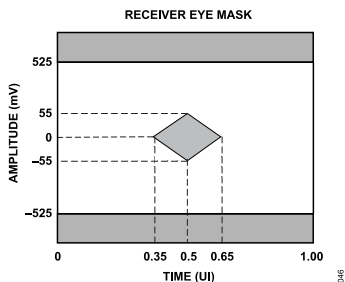

Figure 46. Receiver Eye Mask

### Clock Relationships

The following clocks rates are used throughout the rest of the JESD204B section. The relationship between any of the clocks can be derived from the following equations:

$$\text{Data Rate} = \text{DAC Rate} / \text{Total Interpolation}$$

$$\text{Lane Rate} = (M/L) \times NP \times (10/8) \times \text{Data Rate}$$

$$\text{Byte Rate} = \text{Lane Rate} / 10$$

This relationship comes from 8-bit/10-bit encoding, where each byte is represented by 10 bits.

$$\text{PCLK Rate} = \text{Byte Rate} / 4$$

The processing clock is used for a quad-byte decoder.

$$\text{Frame Rate} = \text{Byte Rate} / F$$

where  $F$  is defined as octets per frame per lane.

$$\text{PCLK Factor} = \text{Frame Rate} / \text{PCLK Rate} = 4/F$$

where:

$M$  is the JESD204B parameter for converters per link.

$L$  is the JESD204B parameter for lanes per link.

$F$  is the JESD204B parameter for octets per frame per lane.

$NP$  is the JESD204B parameter for the total number of bits per sample.

### SERDES PLL

#### Functional Overview of the SERDES PLL

The independent SERDES PLL uses integer N techniques to achieve clock synthesis. The entire SERDES PLL is integrated on chip, including the VCO and the loop filter. The SERDES PLL is capable of providing quadrature clocks to allow a wide range of data rates (3 Gbps to 15 Gbps) with no gaps. These clocks are the input to the CDR block that is described in the [Clock and Data Recovery](#) section.

The reference clock to the SERDES PLL is always running at a frequency,  $f_{REF}$ , that is equal to 1/40 of the lane rate (PCLK rate). For more information about the SERDES circuitry setup and relevant register writes, see the [Start-Up Sequence](#) section. The SERDES PLL block automatically tunes to the appropriate divider range for the lane rate based on the SERDES mode being used. It takes the DAC clock generated by either the DAC PLL, if in use, or from the direct clock being sourced at the CLKIN± pins, divides the DAC clock frequency by 4, and uses the JESD204B parameters corresponding to the mode and interpolation values programmed in Register 0x110 and Register 0x111 to determine the proper dividers for generating the PCLK frequency (lane rate ÷ 40), as shown in [Figure 47](#).

JESD204B SERIAL DATA INTERFACE

Confirm that the SERDES PLL is working by reading Register 0x281. If Register 0x281, Bit 0 = 1, the SERDES PLL has locked.

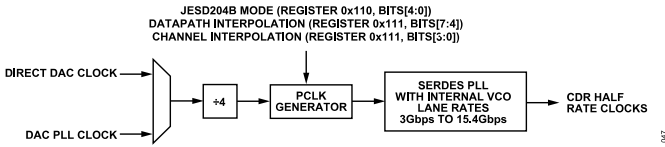

Figure 47. SERDES PLL Synthesizer Block Diagram Including VCO Divider Block

Clock and Data Recovery

The deserializer is equipped with a CDR circuit. Instead of recovering the clock from the JESD204B serial lanes, the CDR recovers the clocks from the SERDES PLL.

The CDR circuit synchronizes the phase used to sample the data on each serial lane independently. This independent phase adjustment per serial interface ensures accurate data sampling and eases the implementation of multiple serial interfaces on a PCB.

Power-Down Unused PHYs

Note that any unused physical and enabled lanes consume extra power unnecessarily. Each lane that is not being used (SERDINx±) must be powered off by writing a 1 to the corresponding bit of PHY\_PD (Register 0x201).

Equalization

To compensate for signal integrity distortions for each PHY channel due to PCB trace length and impedance, the AD9172 employs an easy to use, low power equalizer on each JESD204B channel. The AD9172 equalizers operating at the maximum lane rate of 15 Gbps can compensate for up to 16 dB of insertion loss. This equalizer performance is shown in Figure 48 for 15 Gbps, near the maximum baud rate for the AD9172. The channel must also meet the insertion loss deviation requirement of the JESD204B specification (less than 1.5 dB from 50 MHz to 0.75 times the baud rate).

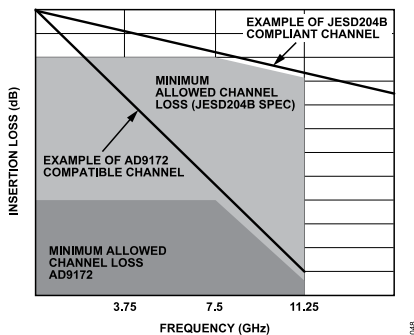

Figure 48. Insertion Loss Allowed

To ensure the AD9172 compensates for the amount of insertion loss in the system, set the equalizer block appropriately. Table 22 shows the settings for the equalizer boost, equalizer gain, and feedback controls, depending on the level of insertion loss in the system. The equalizer boost setting is programmed for each PHY lane (2-bit control for each) being used in Register 0x240 and Register 0x241. Similarly, the equalizer gain settings are programmed for each PHY lane (2-bit control for each) used in Register 0x242 and Register 0x243. The feedback control is programmed per PHY lane (5-bit control for each, one control per register) in Register 0x244 to Register 0x24B.

Table 22. Equalizer Register Control Settings per PHY Control

Insertion Loss	≤11 dB	>11 dB
Equalizer Boost	0x02	0x03
Equalizer Gain	0x01	0x03
Feedback	0x1F	0x1F

Figure 49 and Figure 50 are provided as points of reference for hardware designers and show the insertion loss for various lengths of well laid out stripline and microstrip transmission lines, respectively. See the Hardware Considerations section for specific layout recommendations for the JESD204B channel.

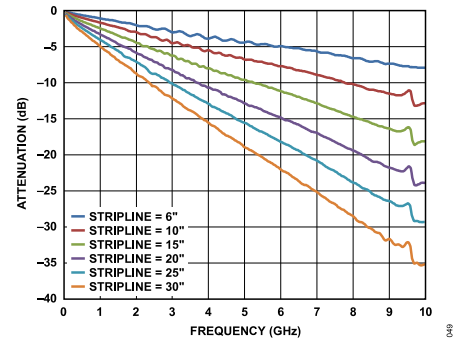

Figure 49. Insertion Loss of 50 Ohm Striplines on FR4

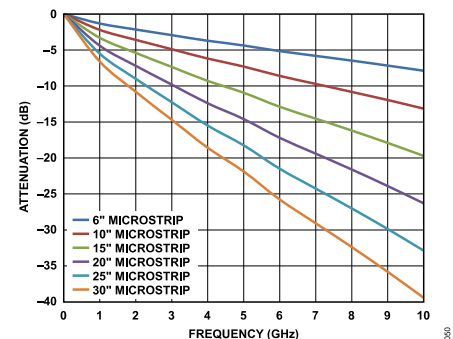

Figure 50. Insertion Loss of 50 Ohm Microstrips on FR4

DATA LINK LAYER

The data link layer of the AD9172 JESD204B interface accepts the deserialized data from the PHYs and deframes and descrambles them so that data octets are presented to the transport layer to be put into DAC samples. The architecture of the data link layer

JESD204B SERIAL DATA INTERFACE

is shown in Figure 51. The data link layer consists of a synchronization FIFO for each lane, a crossbar switch, a deframer, and a descrambler.

The AD9172 can operate as a single-link or dual-link high speed JESD204B serial data interface. All eight lanes of the JESD204B interface handle link layer communications such as code group synchronization (CGS), frame alignment, and frame synchronization.

The AD9172 decodes 8-bit/10-bit control characters, allowing marking of the start and end of the frame and alignment between serial lanes. Each AD9172 serial interface link can issue a synchroniza-

tion request by setting its SYNCOUTx± signals low. The synchronization protocol follows Section 4.9 of the JESD204B standard. When a stream of four consecutive /K/ symbols is received, the AD9172 deactivates the synchronization request by setting the SYNCOUTx± signals high at the next internal LMFC rising edge. Then, the AD9172 waits for the transmitter to issue an initial lane alignment sequence (ILAS). During the ILAS, all lanes are aligned using the /A/ to /R/ character transition as described in the JESD204B Serial Link Establishment section. Elastic buffers hold early arriving lane data until the alignment character of the latest lane arrives. At this point, the buffers for all lanes are released and all lanes are aligned (see Figure 52).

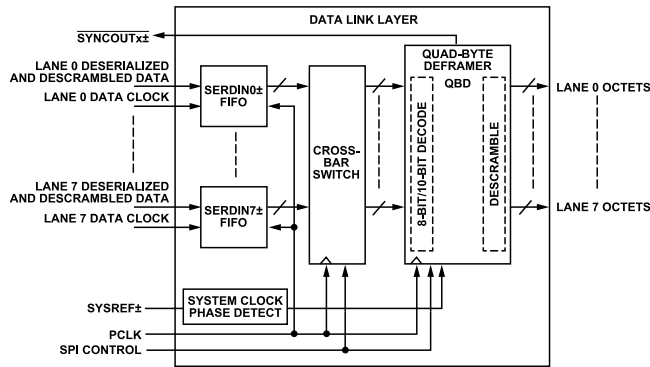

Figure 51. Data Link Layer Block Diagram

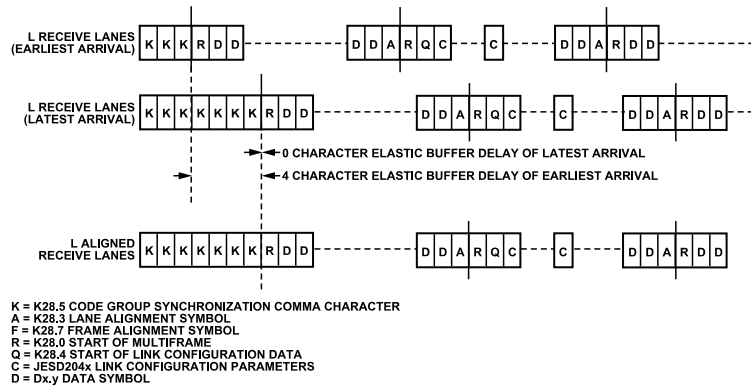

Figure 52. Lane Alignment During ILAS

## JESD204B SERIAL DATA INTERFACE

### JESD204B Serial Link Establishment

A brief summary of the high speed serial link establishment process for Subclass 1 is provided. See Section 5.3.3 of the JESD204B specification document for complete details.

#### Step 1—Code Group Synchronization

Each receiver must locate /K/ (K28.5) characters in its input data stream. After four consecutive /K/ characters are detected on all link lanes, the receiver block deasserts the  $\overline{\text{SYNCOUTx}\pm}$  signals to the transmitter block at the receiver LMFC edge.

The transmitter captures the change in the  $\overline{\text{SYNCOUTx}\pm}$  signals and at a future transmitter LMFC rising edge, starts the ILAS.

#### Step 2—Initial Lane Alignment Sequence

The main purposes of this phase are to align all the lanes of the link and to verify the parameters of the link.

Before the link is established, write each of the link parameters to the receiver device to designate how data is sent to the receiver block.

The ILAS consists of four or more multiframe. The last character of each multiframe is a multiframe alignment character, /A/. The first, third, and fourth multiframe are populated with predetermined data values. Note that Section 8.2 of the JESD204B specifications document describes the data ramp that is expected during the ILAS. The deframer uses the final /A/ of each lane to align the ends of the multiframe within the receiver. The second multiframe contains an /R/ (K.28.0), /Q/ (K.28.4), and then data corresponding to the link parameters. Additional multiframe can be added to the ILAS if needed by the receiver. By default, the AD9172 uses four multiframe in the ILAS (this can be changed in Register 0x478). If using Subclass 1, exactly four multiframe must be used.

After the last /A/ character of the last ILAS, multiframe data begins streaming. The receiver adjusts the position of the /A/ character such that it aligns with the internal LMFC of the receiver at this point.

#### Step 3—Data Streaming

In this phase, data is streamed from the transmitter block to the receiver block.

Optionally, data can be scrambled. Scrambling does not start until the first octet following the ILAS.

The receiver block processes and monitors the data it receives for errors, including the following:

- ▶ Bad running disparity (8-bit/10-bit error)
- ▶ Not in table (8-bit/10-bit error)
- ▶ Unexpected control character
- ▶ Bad ILAS

- ▶ Interlane skew error (through character replacement)

If any of these errors exist, they are reported back to the transmitter in one of the following ways (see the [JESD204B Error Monitoring](#) section for details):

- ▶  $\overline{\text{SYNCOUTx}\pm}$  signal assertion: resynchronization ( $\overline{\text{SYNCOUTx}\pm}$  signals pulled low) is requested at each error for the last two errors. For the first three errors, an optional resynchronization request can be asserted when the error counter reaches a set error threshold.
- ▶ For the first three errors, each multiframe with an error in it causes a small pulse on the respective  $\overline{\text{SYNCOUTx}\pm}$  pins.
- ▶ Errors can optionally trigger an interrupt request (IRQ) event, which can be sent to the transmitter.

For more information about the various test modes for verifying the link integrity, see the [JESD204B Test Modes](#) section.

### Lane First In/First Out (FIFO)

The FIFOs in front of the crossbar switch and deframer synchronize the samples sent on the high speed serial data interface with the deframer clock by adjusting the phase of the incoming data. The FIFO absorbs timing variations between the data source and the deframer; this allows up to two PCLK cycles of drift from the transmitter. The FIFO\_STATUS\_REG\_0 register and FIFO\_STATUS\_REG\_1 register (Register 0x30C and Register 0x30D, respectively) can be monitored to identify whether the FIFOs are full or empty.

### Lane FIFO IRQ

An aggregate lane FIFO error bit is also available as an IRQ event. Use Register 0x020, Bit 2 to enable the lane FIFO error bit, and then use Register 0x024, Bit 2 to read back its status and reset the IRQ signal. See the [Interrupt Request Operation](#) section for more information.

### Crossbar Switch

Register 0x308 to Register 0x30B allow arbitrary mapping of physical lanes (SERDINx $\pm$ ) to logical lanes used by the SERDES deframers.

**Table 23. Crossbar Registers**

Address	Bits	Logical Lane
0x308	[2:0]	SRC_LANE0
0x308	[5:3]	SRC_LANE1
0x309	[2:0]	SRC_LANE2
0x309	[5:3]	SRC_LANE3
0x30A	[2:0]	SRC_LANE4
0x30A	[5:3]	SRC_LANE5
0x30B	[2:0]	SRC_LANE6
0x30B	[5:3]	SRC_LANE7



## JESD204B SERIAL DATA INTERFACE

Write each SRC\_LANE<sub>y</sub> with the number (x) of the desired physical lane (SERDIN<sub>x</sub>±) from which to obtain data. By default, all logical lanes use the corresponding physical lane as their data source. For example, by default, SRC\_LANE0 = 0; therefore, Logical Lane 0 obtains data from Physical Lane 0 (SERDIN0±). To use SERDIN4± as the source for Logical Lane 0 instead, the user must write SRC\_LANE0 = 4.

### Lane Inversion

Register 0x334 allows inversion of desired logical lanes, which can be used to ease routing of the SERDIN<sub>x</sub>± signals. For each Logical Lane x, set Bit x of Register 0x334 to 1 to invert it.

### Deframer

The AD9172 consists of two quad-byte deframers (QBDs) paged by the LINK\_PAGE control in Register 0x300, Bit 2. The deframer accepts the 8-bit/10-bit encoded data from the deserializer (via the crossbar switch), decodes it, and descrambles it into JESD204B frames before passing it to the transport layer to be converted to DAC samples. The deframer processes four symbols (or octets) per processing clock (PCLK) cycle.

The deframer uses the JESD204B parameters that the user has programmed into the register map to identify how the data is packed, and unpacks it. The JESD204B parameters are described in detail in the [Transport Layer](#) section; many of the parameters are also needed in the transport layer to convert JESD204B frames into samples.

### Descrambler

The AD9172 provides an optional descrambler block using a self synchronous descrambler with the following polynomial:  $1 + x^{14} + x^{15}$ .

Enabling data scrambling reduces spectral peaks that are produced when the same data octets repeat from frame to frame. It also makes the spectrum data independent so that possible frequency selective effects on the electrical interface do not cause data dependent errors. Descrambling of the data is enabled by setting the SCR bit (Register 0x453, Bit 7) to 1.

## SYNCING LMFC SIGNALS

The AD9172 requires a synchronization (sync) to align the LMFC and other internal clocks before the SERDES links are brought online. The synchronization is a one-shot sync, where the synchronization process begins on the next edge of the alignment signal following the assertion of the SYSREF\_MODE\_ONESHOT control in Register 0x03A, Bit 1.

In Subclass 1, the SYSREF± rising edge acts as the alignment edge; in Subclass 0, an internal processing clock acts as the alignment edge. When a sync has completed, the SYNC\_ROTATION\_DONE (Register 0x03A, Bit 4) bit is asserted and remains asserted until another sync is requested.

After a synchronization occurs, the JESD204B link can be enabled. In Subclass 1, the latency of the JESD204B system is deterministic and allows synchronization across multiple devices, if desired.

### SYSREF± Signal

The SYSREF± signal is a differential source synchronous input that synchronizes the LMFC signals in both the transmitter and receiver in a JESD204B Subclass 1 system to achieve deterministic latency.

The SYSREF± signal is a rising edge sensitive signal that is sampled by the device clock rising edge. It is best practice that the device clock and SYSREF± signals be generated by the same source, such as the [HMC7044](#) clock generator, so that the phase alignment between the signals is fixed. When designing for optimum deterministic latency operation, consider the timing distribution skew of the SYSREF± signal in a multipoint link system (multichip).

The AD9172 supports a periodic SYSREF± signal. The periodicity can be continuous, strobed, or gapped periodic. The SYSREF± signal can be dc-coupled with a common-mode voltage of 0.6 V to 2.2 V and differential swing of 200 mV p-p to 1 V p-p. When dc-coupled, a small amount of common-mode current (up to 0.3 mA) is drawn from the SYSREF± pins. See [Figure 53](#) and [Figure 54](#) for the SYSREF± internal circuit for dc-coupled and ac-coupled configurations. Ensure that the SYSREF\_INPUTMODE bit (Register 0x084, Bit 6) is set to 1, dc-coupled, to prevent overstress on the SYSREF± receiver pins.

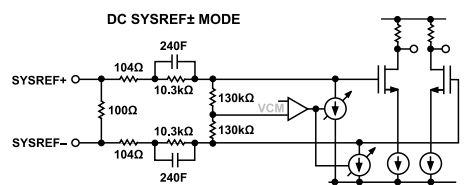

Figure 53. DC-Coupled SYSREF± Receiver Circuitry

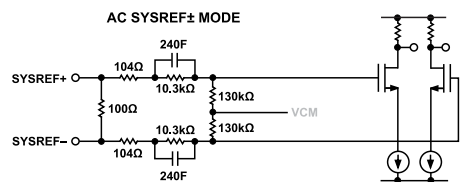

Figure 54. AC-Coupled SYSREF± Receiver Circuitry

To avoid this common-mode current draw, the SYSREF± receiver can be ac-coupled using a 50% duty cycle periodic SYSREF± signal with ac coupling capacitors. If ac-coupled, the ac coupling capacitors combine with the resistors shown in [Figure 54](#) to make a high-pass filter with an RC time constant of  $\tau = RC$ . Select C such that  $\tau > 4/\text{SYSREF}\pm$  frequency. In addition, the edge rate must be sufficiently fast to allow SYSREF± sampling clocks to correctly sample the rising SYSREF± edge before the next sample clock.

## JESD204B SERIAL DATA INTERFACE

When ac coupling the SYSREF± inputs, ensure that the SYSREF\_INPUTMODE bit (Register 0x084, Bit 6) is set to 0, ac-coupled, to enable the internal receiver biasing circuitry and prevent overstress on the SYSREF± receiver pins. AC coupling allows a differential voltage swing from 200 mV to 1 V on the SYSREF± pins.

### SYSREF± Sampling

The SYSREF± signal is sampled by a divide by 4 version of the DAC clock. Therefore, the minimum pulse width of the SYSREF± signal must exceed 4 DAC clock periods to ensure accurate sampling. The delay between the SYSREF± and DAC clock input signal does not need to be timing constrained.

By default, the first SYSREF± rising edge at the SYSREF± inputs that is detected after asserting the SYSREF\_MODE\_ONESHOT bit (Register 0x03A, Bit 1) begins the synchronization and aligns the internal LMFC signal with the sampled SYSREF± edge.

Register 0x036 (SYSREF\_COUNT) indicates how many captured SYSREF± edges are ignored after the SYSREF\_MODE\_ONESHOT bit is asserted before the synchronization takes place. For example, if SYSREF\_COUNT is set to 3, the AD9172 does not sync after the SYSREF\_MODE\_ONESHOT bit is asserted until the arrival of the 4th SYSREF± edge.

### SYSREF± Jitter IRQ

In Subclass 1, after the one-shot synchronization occurs, the SYSREF± signal is monitored to ensure that the subsequent SYSREF± edges do not deviate from the internal LMFC clock by more than a target amount.

Register 0x039 (SYSREF\_ERR\_WINDOW) indicates the size of the error window allowed, in DAC clock units. If a SYSREF± edge varies from the internal LMFC clock by more than the number of DAC clock units set in SYSREF\_ERR\_WINDOW, the IRQ\_SYSREF\_JITTER is asserted.

**Table 24. SYSREF± Jitter Window Tolerance**

SYSREF± Jitter Window Tolerance (DAC Clock Cycles)	SYSREF_ERR_WINDOW (Register 0x039, Bits[5:0]) <sup>1</sup>
±½	0x00
±4	0x04
±8	0x08
±12	0x0C
±16	0x10
±20	0x14
+24	0x18
±28	0x1C

<sup>1</sup> The two least significant digits are ignored because the SYSREF± signal is sampled with a divide by 4 version of the DAC clock. As a result, the jitter window is set by this divide by 4 clock rather than the DAC clock. It

**Table 24. SYSREF± Jitter Window Tolerance**

SYSREF± Jitter Window Tolerance (DAC Clock Cycles)	SYSREF_ERR_WINDOW (Register 0x039, Bits[5:0]) <sup>1</sup>
--	--

is recommended that at least a four-DAC clock SYSREF± jitter window be chosen.

The IRQ\_SYSREF\_JITTER can be configured as described in the [Interrupt Request Operation](#) section to indicate the SYSREF± signal has varied, and to request the SPI sequence for a sync be performed again.

### Sync Procedure

The procedure for enabling the sync is as follows:

1. Set up the DAC and the SERDES PLL, and enable the CDR (see the [Start-Up Sequence](#) section).
2. Set Register 0x03B to 0xF1 to enable the synchronization circuitry. If using the soft on/off feature, set Register 0x03B to 0xF3 to ramp the datapath data before and after the synchronization.
3. If Subclass 1, configure the SYSREF± settings as follows:
  - a. Set Register 0x039 (SYSREF± jitter window). See [Table 24](#) for settings.
  - b. Set Register 0x036 = SYSREF\_COUNT; leave as 0 to bypass.
4. Perform a one-shot sync.
  - a. Set Register 0x03A = 0x00. Clear one-shot mode if already enabled.
  - b. Set Register 0x03A = 0x02. Enable one-shot sync mode.
5. If Subclass 1, send a SYSREF± edge. If pulse counting, multiple SYSREF± edges are required. Sending SYSREF± edges triggers the synchronization.
6. Read back the SYNC\_ROTATION\_DONE bit (Register 0x03A, Bit 4) to confirm the rotation occurred.

### Resynchronizing LMFC Signals

If desired, the sync procedure can be repeated to realign the LMFC clock to the reference signal by repeating Step 2 to Step 6, described in the [Sync Procedure](#) section. When the one-shot sync is triggered (writing Register 0x03A = 0x02), the SYNCOUTx± signals deassert to drop the JESD204B links and reassert the links after the rotation completes.

### Deterministic Latency

JESD204B systems contain various clock domains distributed throughout. Data traversing from one clock domain to a different clock domain can lead to ambiguous delays in the JESD204B link. These ambiguities lead to nonrepeatable latencies across the link from power cycle to power cycle with each new link establishment. Section 6 of the JESD204B specification addresses the issue of



**JESD204B SERIAL DATA INTERFACE**

deterministic latency with mechanisms defined as Subclass 1 and Subclass 2.

The AD9172 supports JESD204B Subclass 0 and Subclass 1 operation, but not Subclass 2. Write the subclass to Register 0x458, Bits[7:5].

**Subclass 0**

This mode gives deterministic latency to within several PCLK cycles. It does not require any signal on the SYSREF± pins, which can be left disconnected.

Subclass 0 still requires that all lanes arrive within the same LMFC cycle and the dual DACs must be synchronized to each other.

**Subclass 1**

This mode gives deterministic latency and allows the link to synchronize within a few DAC clock cycles. Across the full operating range, for both supply and temperature, it is within ±2.5 DAC clock

periods for a 6 GHz DAC clock rate or ±4 DAC clock periods for a 12.6 GHz DAC clock rate. If the supply and the temperature stability are maintained, the link can be synchronized to within ±1.5 DAC clock periods for a 6 GHz DAC clock rate or ±2.5 DAC clock periods for a 12.6 GHz DAC clock rate. Achieving this latency requires an external, low jitter SYSREF± signal that is accurately phase aligned to the DAC clock.

**Deterministic Latency Requirements**

Several key factors are required for achieving deterministic latency in a JESD204B Subclass 1 system, as follows:

- ▶ The SYSREF± signal distribution skew within the system must be less than the desired uncertainty.
- ▶ The total latency variation across all lanes, links, and devices must be ≤12 PCLK periods, which includes both variable delays and the variation in fixed delays from lane to lane, link to link, and device to device in the system.

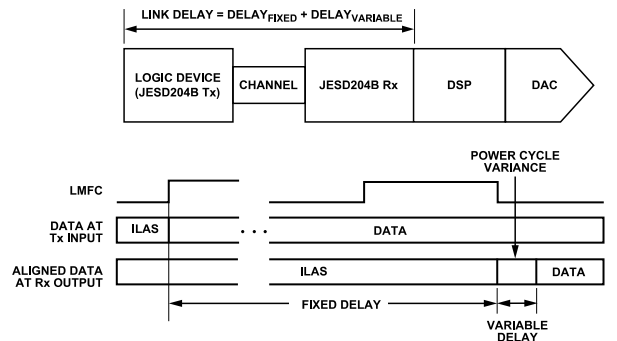

Figure 55. JESD204B Link Delay = Fixed Delay + Variable Delay

## JESD204B SERIAL DATA INTERFACE

### Link Delay

The link delay of a JESD204B system is the sum of the fixed and variable delays from the transmitter, channel, and receiver as shown in [Figure 55](#).

For proper functioning, all lanes on a link must be read during the same LMFC period. Section 6.1 of the JESD204B specification states that the LMFC period must be larger than the maximum link delay. For the AD9172, this is not necessarily the case; instead, the AD9172 use a local LMFC for each link ( $LMFC_{Rx}$ ) that can be delayed from the  $SYSREF_{\pm}$  aligned LMFC. Because the LMFC is periodic, this delay can account for any amount of fixed delay. As a result, the LMFC period must only be larger than the variation in the link delays, and the AD9172 can achieve proper performance with a smaller total latency. [Figure 56](#) and [Figure 57](#) show a case where the link delay is greater than an LMFC period. Note that it can be accommodated by delaying  $LMFC_{Rx}$ .

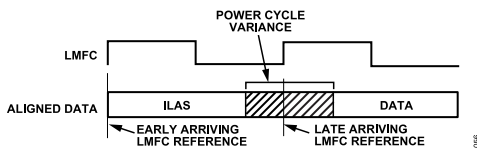

Figure 56. Link Delay > LMFC Period Example

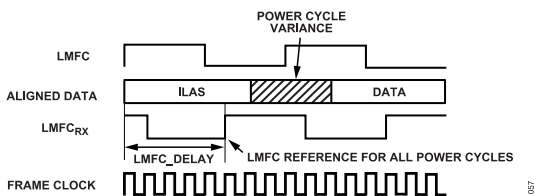

Figure 57.  $LMFC\_DELAY_x$  to Compensate for Link Delay > LMFC

The method to select the  $LMFC_{Del}$  (Register 0x304) and  $LMFC_{Var}$  (Register 0x306) variables is described in the [Link Delay Setup Example, with Known Delays](#) section and the [Link Delay Setup Example, Without Known Delay](#) section. Note that the setting for  $LMFC_{Del}$  must not equal or exceed the number of PCLK cycles per LMFC period in the current mode. Similarly,  $LMFC_{Var}$  must not exceed the number of PCLK cycles per LMFC period in the current mode or be set to <12 (whichever value is smaller).

Setting  $LMFC_{Del}$  appropriately ensures that all the corresponding data samples arrive in the same LMFC period. Then,  $LMFC_{Var}$  is written into the receive buffer delay (RBD) to absorb all link delay variation. This write ensures that all data samples arrived before reading. By setting these to fixed values across runs and devices, deterministic latency is achieved.

The RBD described in the JESD204B specification takes values from one frame clock cycle to  $|K|$  frame clock cycles, and the RBD of the AD9172 takes values from 0 PCLK cycle to 12 PCLK cycles. As a result, up to 12 PCLK cycles of total delay variation can be absorbed.  $LMFC_{Var}$  and  $LMFC_{Del}$  are both in PCLK cycles. The PCLK factor, or number of frame clock cycles per PCLK cycle, is

equal to  $4/f$ . For more information on this relationship, see the [Clock Relationships](#) section.

Two examples follow that show how to determine  $LMFC_{Var}$  and  $LMFC_{Del}$ . After they are calculated, write  $LMFC_{Del}$  into Register 0x304 for all devices in the system, and write  $LMFC_{Var}$  to Register 0x306 for all devices in the system.

### Link Delay Setup Example, with Known Delays

All the known system delays can be used to calculate  $LMFC_{Var}$  and  $LMFC_{Del}$ .

The example shown in [Figure 58](#) is demonstrated in the following steps. Note that this example is in Subclass 1 to achieve deterministic latency, and the example uses the case for  $F = 2$ ; therefore, the number of PCLK cycles per multiframe = 16. Because  $PCB_{Fixed} \ll$  PCLK Period,  $PCB_{Fixed}$  is negligible in this example and not included in the calculations.

- Find the receiver delays using [Table 6](#).  
 $Rx_{Fixed} = 13$  PCLK cycles  
 $Rx_{Var} = 2$  PCLK cycles
- Find the transmitter delays. The equivalent table in the example JESD204B core (implemented on a GTH or GTX gigabit transceiver on a Virtex-6 FPGA) states that the delay is  $56 \pm 2$  byte clock cycles.
- Because the PCLK rate =  $ByteRate/4$  as described in the [Clock Relationships](#) section, the transmitter delays in PCLK cycles are calculated as follows:  
 $Tx_{Fixed} = 54/4 = 13.5$  PCLK cycles  
 $Tx_{Var} = 4/4 = 1$  PCLK cycle
- Calculate  $MinDelayLane$  as follows:  
 $MinDelayLane = \text{floor}(Rx_{Fixed} + Tx_{Fixed} + PCB_{Fixed})$   
 $= \text{floor}(13 + 13.5 + 0)$   
 $= \text{floor}(26.5)$   
 $MinDelayLane = 26$
- Calculate  $MaxDelayLane$  as follows:  
 $MaxDelayLane = \text{ceiling}(Rx_{Fixed} + Rx_{Var} + Tx_{Fixed} + Tx_{Var} + PCB_{Fixed})$   
 $= \text{ceiling}(13 + 2 + 13.5 + 1 + 0)$   
 $= \text{ceiling}(29.5)$   
 $MaxDelayLane = 30$
- Calculate  $LMFC_{Var}$  as follows:  
 $LMFC_{Var} = (MaxDelay + 1) - (MinDelay - 1)$   
 $= (30 + 1) - (26 - 1) = 31 - 25$   
 $LMFC_{Var} = 6$  PCLK cycles
- Calculate  $LMFC_{Del}$  as follows:  
 $LMFC_{Del} = (MinDelay - 1) \% (PCLKsperMF)$   
 $= (26 - 1) \% 16$   
 $= 25 \% 16$   
 $LMFC_{Del} = 9$  PCLK cycles  
 Write  $LMFC_{Del}$  to Register 0x304 for all devices in the system.  
 Write  $LMFC_{Var}$  to Register 0x306 for all devices in the system.

## JESD204B SERIAL DATA INTERFACE

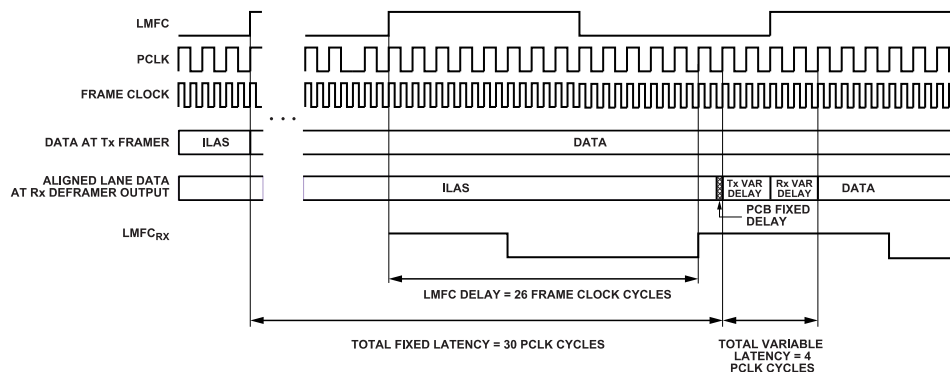

Figure 58. LMFC Delay Calculation Example

### Link Delay Setup Example, Without Known Delay

If the system delays are not known, the AD9172 can read back the link latency between  $LMFC_{RX}$  for each link (with the  $LMFC_{Del}$  setting subtracted out) and the  $SYSREF_{\pm}$  aligned LMFC. This information is then used to calculate  $LMFC_{Var}$  and  $LMFC_{Del}$ .

Figure 60 shows how  $DYN\_LINK\_LATENCY\_0$  (Register 0x302) provides a readback showing the delay (in PCLK cycles) between  $LMFC_{RX}$  minus the  $LMFC\_DELAY\_x$  (fixed delay) setting set in the SPI at that time and the transition from the ILAS to the first data sample. By repeatedly power cycling and taking this measurement, the minimum and maximum delays across power cycles can be determined and used to calculate  $LMFC_{Var}$  and  $LMFC_{Del}$ .

In Figure 60, for Link A, Link B, and Link C, the system containing the AD9172 (including the transmitter) is power cycled and configured 20 times. The AD9172 is configured as described in the Sync Procedure section. Because the purpose of this exercise is to determine  $LMFC_{Del}$  and  $LMFC_{Var}$ , the  $LMFC_{Del}$  value is programmed to 0 and the  $DYN\_LINK\_LATENCY\_0$  value is read from Register 0x302. The variation in the link latency over the 20 runs is shown in Figure 60, described as follows:

- ▶ Link A gives readbacks of 6, 7, 0, and 1. Note that the set of recorded delay values rolls over the edge of a multiframe at the boundary of  $K/PCLK$  factor = 8. Add the number of PCLK cycles per multiframe = 8 to the readback values of 0 and 1 because they rolled over the edge of the multiframe. Delay values range from 6 to 9.
- ▶ Link B gives delay values from 5 to 7.
- ▶ Link C gives delay values from 4 to 7.

The example shown in Figure 60 is demonstrated in the following steps. Note that this example is in Subclass 1 to achieve deterministic latency, and the example uses the case for  $F = 1$ ; therefore, the number of PCLK cycles per multiframe = 8.

1. Calculate the minimum of all delay measurements across all power cycles, links, and devices as follows:

$$MinDelay = \min(\text{all Delay values}) = 4$$

2. Calculate the maximum of all delay measurements across all power cycles, links, and devices as follows:

$$MaxDelay = \max(\text{all Delay values}) = 9$$

3. Set  $LMFC_{Var}$  to the maximum of 12 PCLK cycles. If latency is required to be minimized for a given application, calculate the total delay variation (with 2 PCLK cycles of guard band on each end) across all power cycles, links, and devices as follows:

$$LMFC_{Var} = (MaxDelay + 2) - (MinDelay - 2)$$

$$= (9 + 2) - (4 - 2) = 11 - 2 = 9 \text{ PCLK cycles}$$

4. Calculate the minimum delay in PCLK cycles (with 2 PCLK cycles of guard band) across all power cycles, links, and devices as follows:

$$LMFC_{Del} = (MinDelay - 2) \% (PCLKsperMF)$$

$$= (4 - 2) \% 8$$

$$= 2 \% 8 = 2 \text{ PCLK cycles}$$

5. Write  $LMFC_{Del}$  to Register 0x304 for all devices in the system. Write  $LMFC_{Var}$  to Register 0x306 for all devices in the system.

JESD204B SERIAL DATA INTERFACE

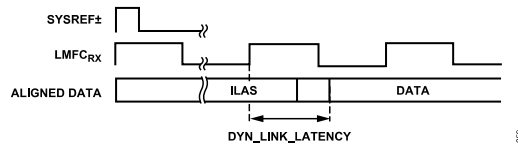

Figure 59. DYN\_LINK\_LATENCY\_x Illustration

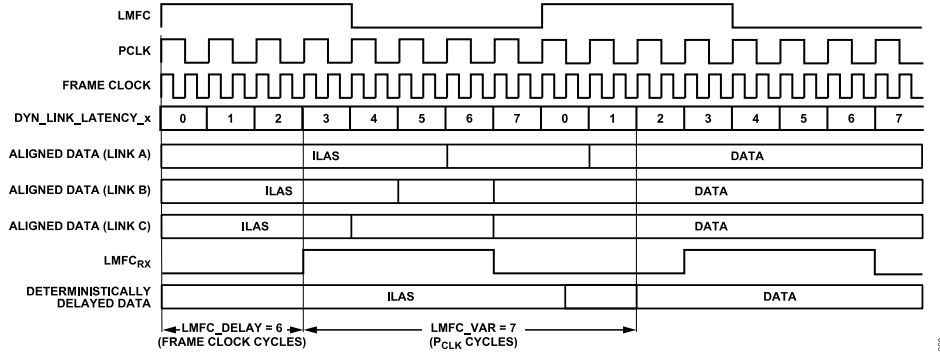

Figure 60. Multilink Synchronization Settings, Derived Method Example

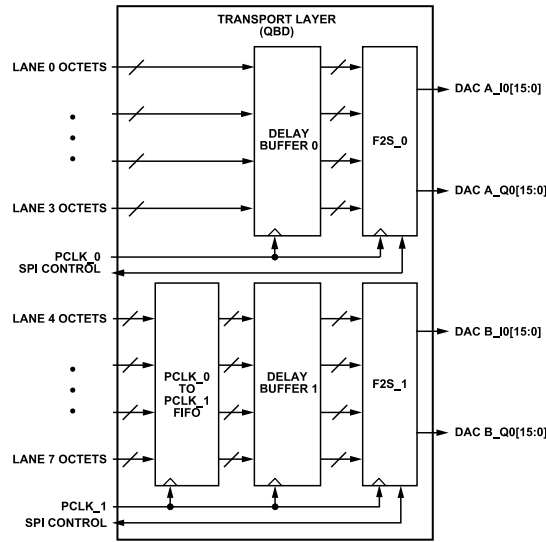

Figure 61. Transport Layer Block Diagram

## JESD204B SERIAL DATA INTERFACE

## TRANSPORT LAYER

The transport layer receives the descrambled JESD204B frames and converts them to DAC samples based on the programmed JESD204B parameters shown in Table 25. The device parameters are defined in Table 26.

Table 25. JESD204B Transport Layer Parameters

Parameter	Description
F	Number of octets per frame per lane: 1, 2, 3, 4 or 8.
K	Number of frames per multiframe: K = 32.
L	Number of lanes per converter device (per link), as follows: 1, 2, 3, 4 or 8.
M	Number of converters per device (per link), as follows: For real data modes, M is the number of real data converters (if total interpolation is 1×). For complex data modes, M is the number of complex data subchannels.
S	Number of samples per converter, per frame: 1, 2, 4 or 8.

Table 26. Table 26. JESD204B Device Parameters

Parameter	Description
CF	Number of control words per device clock per link. Not supported, must be 0.

Table 28. Single-Link JESD204B Operating Modes

Parameter	Single-Link JESD204B Modes																
	0	1	2	3	4	5	6	7	8	9	10	11	12	18	19	20	21
L (Lane Count)	1	2	3	2	4	1	2	1	4	4	8	8	8	4	4	8	8
M (Converter Count)	2	4	6	2	4	2	4	4	2	2	2	2	2	1	1	1	1
F (Octets per Frame per Lane)	4	4	4	2	2	3	3	8	1	2	1	2	3	1	2	1	2
S (Samples per Converter per Frame)	1	1	1	1	1	1	1	1	1	2	2	4	8	2	4	4	8
NP (Total Number of Bits per Sample)	16	16	16	16	16	12	12	16	16	16	16	16	12	16	16	16	16
N (Converter Resolution)	16	16	16	16	16	12	12	16	16	16	16	16	12	16	16	16	16

Table 29. Dual-Link JESD204B Operating Modes

Parameter	Dual-Link JESD204B Modes												
	0	1	2	3	4	5	6	7	8	9	18	19	
L (Lane Count)	1	2	3	2	4	1	2	1	4	4	4	4	
M (Converter Count)	2	4	6	2	4	2	4	4	2	2	1	1	
F (Octets per Frame per Lane)	4	4	4	2	2	3	3	8	1	2	1	2	
S (Samples per Converter per Frame)	1	1	1	1	1	1	1	1	1	2	2	4	
NP (Total number of Bits per Sample)	16	16	16	16	16	12	12	16	16	16	16	16	
N (Converter Resolution)	16	16	16	16	16	12	12	16	16	16	16	16	

Table 26. Table 26. JESD204B Device Parameters

Parameter	Description
CS	Number of control bits per conversion sample. Not supported, must be 0.
HD	High density user data format. This parameter is always set to 1.
N	Converter resolution.
N' (or NP)	Total number of bits per sample.

Certain combinations of these parameters are supported by the AD9172. See Table 28 and Table 29 for a list of supported single-link and dual-link modes, respectively. Table 28 and Table 29 lists the JESD204B parameters for each of the modes. Table 27 lists JESD204B parameters that have fixed values.

Table 27. JESD204B Parameters with Fixed Values

Parameter	Value
K	32
CF	0
HD	1
CS	0

## JESD204B SERIAL DATA INTERFACE

### Configuration Parameters

The AD9172 modes refer to the link configuration parameters for L, K, M, N, NP, S, and F. Table 30 provides the description and addresses for these settings.

Table 30. Configuration Parameters

Setting	Description	Address
L - 1	Number of lanes minus 1.	Register 0x453, Bits[4:0]
F - 1	Number of ((octets per frame) per lane) minus 1.	Register 0x454, Bits[7:0]
K - 1	Number of frames per multiframe minus 1.	Register 0x455, Bits[4:0]
M - 1	Number of converters minus 1.	Register 0x456, Bits[7:0]
N - 1	Converter bit resolution minus 1.	Register 0x457, Bits[4:0]
NP - 1	Bit packing per sample minus 1.	Register 0x458, Bits[4:0]
S - 1	Number of ((samples per converter) per frame) minus 1.	Register 0x459, Bits[4:0]
HD	High density format. Set to 1.	Register 0x45A, Bit 7
DID	Device ID. Match the device ID sent by the transmitter.	Register 0x450, Bits[7:0]
BID	Bank ID. Match the bank ID sent by the transmitter.	Register 0x451, Bits[7:0]
LID0	Lane ID for Lane 0. Match the Lane ID sent by the transmitter on Logical Lane 0.	Register 0x452, Bits[4:0]
JESDV	JESD204x version. Match the version sent by the transmitter (0x0 = JESD204A, 0x1 = JESD204B).	Register 0x459, Bits[7:5]

The AD9172 truncates the output of the main digital datapath to the value of N bits for the selected mode, which is then sent to the DAC core. It is possible to send the value of NP number of bits worth of data with the lower NP - N LSBs padded as 0s, or to send the full NP number of bits data across the SERDES lanes. In either case, the lower NP - N LSBs are truncated prior to the DAC core.

### Data Flow Through the JESD204B Receiver

The link configuration parameters determine how the serial bits on the JESD204B receiver interface are deframed and passed on to the DACs as data samples.

### Deskewing and Enabling Logical Lanes

After proper configuration, the logical lanes are automatically deskewed. All logical lanes are enabled or not based on the number of lanes for the mode setting chosen in Register 0x110, Bits[4:0]. The physical lanes are all powered up by default. To disable power to physical lanes that are not being used, set Bit x in Register 0x201 to 1 to disable Physical Lane x, and keep it at 0 to enable it. The logical lanes must be enabled and deskewed on a per link

basis using the LINK\_PAGE control (Register 0x300, Bit 2). Set Bit x in Register 0x46C to 1 to deskew Link Logical Lane x for the selected link page.

## JESD204B TEST MODES

### PHY PRBS Testing

The JESD204B receiver on the AD9172 includes a PRBS pattern checker on the back end of its physical layer. This functionality enables bit error rate (BER) testing of each physical lane of the JESD204B link. The PHY PRBS pattern checker does not require that the JESD204B link be established. It can synchronize with a PRBS7, PRBS15, or PRBS31 data pattern. PRBS pattern verification can be performed on multiple lanes at once. The error counts for failing lanes are reported for one JESD204B lane at a time. The process for performing PRBS testing on the AD9172 is as follows:

1. Start sending a PRBS7, PRBS15, or PRBS31 pattern from the JESD204B transmitter.
2. Select and write the appropriate PRBS pattern to Register 0x316, Bits[3:2], as shown in Table 31.
3. Enable the PHY test for all lanes being tested by writing to PHY\_TEST\_EN (Register 0x315). Each bit of Register 0x315 enables the PRBS test for the corresponding lane. For example, writing a 1 to Bit 0 enables the PRBS test for Physical Lane 0.
4. Toggle PHY\_TEST\_RESET (Register 0x316, Bit 0) from 0 to 1 then back to 0.
5. Set PHY\_PRBS\_TEST\_THRESHOLD\_xBITS (Bits[23:0], Register 0x319 to Register 0x317) as desired.
6. Write a 0 and then a 1 to PHY\_TEST\_START (Register 0x316, Bit 1). The rising edge of PHY\_TEST\_START starts the test.
  - a. (Optional) In some cases, it may be necessary to repeat Step 4 at this point. Toggle PHY\_TEST\_RESET (Register 0x316, Bit 0) from 0 to 1, then back to 0.
7. Wait 500 ms.
8. Stop the test by writing PHY\_TEST\_START (Register 0x316, Bit 1) = 0.
9. Read the PRBS test results.
  - a. Each bit of PHY\_PRBS\_PASS (Register 0x31D) corresponds to one SERDES lane (0 = fail, 1 = pass).
  - b. The number of PRBS errors seen on each failing lane can be read by writing the lane number to check (0 to 7) in PHY\_SRC\_ERR\_CNT (Register 0x316, Bits[6:4]) and reading the PHY\_PRBS\_ERR\_CNT\_xBITS (Register 0x31A to Register 0x31C). The maximum error count is  $2^{24} - 1$ . If all bits of Register 0x31A to Register 0x31C are high, the maximum error count on the selected lane is exceeded.



## JESD204B SERIAL DATA INTERFACE

**Table 31. PHY PRBS Pattern Selection**

PHY_PRBS_PAT_SEL Setting (Register 0x316, Bits[3:2])	PRBS Pattern
0b00 (default)	PRBS7
0b01	PRBS15
0b10	PRBS31

### Transport Layer Testing

The JESD204B receiver in the AD9172 supports the short transport layer (STPL) test as described in the JESD204B standard. Use this test to verify the data mapping between the JESD204B transmitter and receiver. To perform this test, this function must be implemented and enabled in the logic device. Before running the test on the receiver side, the link must be established and running without errors.

The STPL test ensures that each sample from each converter is mapped appropriately according to the number of converters (M) and the number of samples per converter (S). As specified in the JESD204B standard, the converter manufacturer specifies the test samples that are transmitted. Each sample must have a unique value. For example, if M = 2 and S = 2, four unique samples are transmitted repeatedly until the test is stopped. The expected sample must be programmed into the device and the expected sample is compared to the received sample one sample at a time until all are tested. The process for performing this test on the AD9172 is described as follows:

1. Synchronize the JESD204B link.
2. Enable the STPL test at the JESD204B Tx.
3. Depending on JESD204B case, there may be up to six complex subchannels (M = 6), and each frame may contain up to eight samples (S = 8). Configure the SHORT\_TPL\_REF\_SP\_MSB bits (Register 0x32E) and the SHORT\_TPL\_REF\_SP\_LSB bits (Register 0x32D) to match one of the samples for one converter within one frame. For N = 12 modes, the expected sample value is multiplied by 16.
4. Set SHORT\_TPL\_M\_SEL (Register 0x32C, Bits[3:2]) to select the channel.
5. Set SHORT\_TPL\_IQ\_SAMPLE\_SEL (Register 0x32F, Bit 6) to select the I or Q subchannel.
6. Set SHORT\_TPL\_SP\_SEL (Register 0x32C, Bits[7:4]) to select the sample within one frame for the selected .
7. Set SHORT\_TPL\_TEST\_EN (Register 0x32C, Bit 0) to 1.
8. Set SHORT\_TPL\_TEST\_RESET (Register 0x32C, Bit 1) to 1, then back to 0.
9. Wait for the desired time. The desired time is calculated as  $1/(\text{sample rate} \times \text{BER})$ . For example, given a bit error rate of  $\text{BER} = 1 \times 10^{-10}$  and a sample rate = 1 GSPS, the desired time = 10 sec. Then, set SHORT\_TPL\_TEST\_EN to 0.
10. Read the test result at SHORT\_TPL\_FAIL (Register 0x32F, Bit 0).

11. Choose another sample for the same or another M to continue with the test, until all samples for both converters from one frame are verified.

### Internal Loop Back Test

The AD9172 integrates one internal PRBS generator that can be used to test the JESD204B PHYs without an external SERDES signal input. The process for performing internal loopback testing on the AD9172 is as follows:

1. Set the EQ\_BOOST\_PHYx bits (Register 0x240, Bits[7:0] and Register 0x241, Bit[7:0]) to 0.
2. Set SEL\_IF\_PARDATAINV\_DES\_RC\_CH bits (Register 0x234, Bits[7:0]) to 0 to make sure lanes not inverted.
3. Enable the loop back test for all lanes being tested by writing to EN\_LBT\_DES\_RC\_CH (Register 0x250). Each bit of Register 0x250 enables the loop back test for the corresponding lane. For example, writing a 1 to Bit 0 enables the test for Physical Lane 0.
4. For half-rate, set EN\_LBT\_HALFRATE\_DES\_RC (Register 0x251, Bit 1) to 1; otherwise, set it to 0.
5. Toggle INIT\_LBT\_SYNC\_DES\_RC (Register 0x251, Bit 0) from 0 to 1 then back to 0.
6. Refer to the [PHY PRBS Testing](#) section for information on how to run a PRBS7 check.

### Repeated CGS and ILAS Test

As per Section 5.3.3.8.2 of the JESD204B specification, the AD9172 can check that a constant stream of /K28.5/ characters is being received, or that CGS followed by a constant stream of ILAS is being received.

To run a repeated CGS test, send a constant stream of /K28.5/ characters to the AD9172 SERDES inputs. Next, set up the device and enable the links. Ensure that the /K28.5/ characters are being received by verifying that SYNCOUT± is deasserted and that CGS has passed for all enabled link lanes by reading Register 0x470.

To run the CGS followed by a repeated ILAS sequence test, follow the procedure to set up the links, but before performing the last write (enabling the links), enable the ILAS test mode by writing a 1 to Register 0x477, Bit 7. Then, enable the links. When the device recognizes four CGS characters on each lane, it deasserts the SYNCOUT±. At this point, the transmitter starts sending a repeated ILAS sequence.

Read Register 0x473 to verify that the initial lane synchronization has passed for all enabled link lanes.

## JESD204B SERIAL DATA INTERFACE

### JESD204B ERROR MONITORING

#### Disparity, Not in Table, and Unexpected Control (K) Character Errors

As per Section 7.6 of the JESD204B specification, the AD9172 can detect disparity errors, not in table (NIT) errors, and unexpected control character errors, and can optionally issue a sync request and reinitialize the link when errors occur.

Several other interpretations of the JESD204B specification are noted in this section. When three NIT errors are injected to one lane and QUAL\_RDERR (Register 0x476, Bit 4) = 1, the readback values of the bad disparity error (BDE) count register is 1. Reporting of disparity errors that occur at the same character position of an NIT error is disabled. No such disabling is performed for the disparity errors in the characters after an NIT error. Therefore, it is expected behavior that an NIT error may result in a BDE error.

#### Checking Error Counts

The error count can be checked for disparity errors, NIT errors, and unexpected control character errors. The error counts are on a per lane and per error type basis. Each error type and lane has a register dedicated to it. To check the error count, the following steps must be performed:

1. Choose and enable which errors to monitor by selecting them in Register 0x480, Bits[5:3] to Register 0x487, Bits[5:3]. Unexpected K (UEK) character, BDE, and NIT error monitoring can be selected for each lane by writing a 1 to the appropriate bit, as described in Table 60. These bits are enabled by default.
2. The corresponding error counter reset bits are in Register 0x480, Bits[2:0] to Register 0x487, Bits[2:0]. Write a 1 to the corresponding bit to reset that error counter.
3. Registers 0x488, Bits[2:0] to Register 0x48F, Bits[2:0] have the terminal count hold indicator for each error counter. If this flag is enabled, when the terminal error count of 0xFF is reached, the counter ceases counting and holds that value until reset. Otherwise, it wraps to 0x00 and continues counting. Select the desired behavior and program the corresponding register bits per lane.

#### Check for Error Count Over Threshold

To check for the error count over threshold, follow these steps:

1. Define the error counter threshold. The error counter threshold can be set to a user defined value in Register 0x47C, or left to the default value of 0xFF. When the error threshold is reached, an IRQ is generated, SYNCOUTx± is asserted, or both, depending on the mask register settings. This one error threshold is used for all three types of errors (UEK, NIT, and BDE).
2. Set the SYNC\_ASSERT\_MASK bits. The SYNCOUTx± assertion behavior is set in Register 0x47D, Bits[2:0]. By default,

when any error counter of any lane is equal to the threshold, it asserts (Register 0x47D, Bits[2:0] = 0b111). When setting the SYNC\_ASSERT\_MASK bits, LINK\_PAGE (Register 0x300, Bit 2) must be set to 1.

3. Read the error count reached indicator. Each error counter has a terminal count reached indicator, per lane. This indicator is set to 1 when the terminal count of an error counter for a particular lane is reached. These status bits are located in Register 0x490, Bits[2:0] to Register 0x497, Bits[2:0]. Bit 3 can be read back to indicate whether a particular lane is active.

#### Error Counter and IRQ Control

For error counter and IRQ control, follow these steps:

1. Enable the interrupts. Enable the JESD204B interrupts. The interrupts for the UEK, NIT, and BDE error counters are in Register 0x4B8, Bits[7:5]. There are other interrupts to monitor when bringing up the link, such as lane deskewing, initial lane sync, good check sum, frame sync, code group sync (Register 0x4B8, Bits[4:0]), and configuration mismatch (Register 0x4B9, Bit 0). These bits are off by default but can be enabled by writing 0b1 to the corresponding bit.
2. Read the JESD204B interrupt status. The interrupt status bits are in Register 0x4BA, Bits[7:0] and Register 0x4BB, Bit 0, with the status bit position corresponding to the enable bit position.
3. It is recommended to enable all interrupts that are planned to be used prior to bringing up the JESD204B link. When the link is up, the interrupts can be reset and then used to monitor the link status.

#### Monitoring Errors via SYNCOUTx±

When one or more disparity, NIT, or unexpected control character errors occur, the error is reported on the SYNCOUTx± pin as per Section 7.6 of the JESD204B specification. The JESD204B specification states that the SYNCOUTx± signal is asserted for exactly two frame periods when an error occurs. For the AD9172, the width of the SYNCOUTx± pulse can be programmed to ½, 1, or 2 PCLK cycles. The settings to achieve a SYNCOUTx± pulse of two frame clock cycles are given in Table 32.

Table 32. Setting SYNCOUTx± Error Pulse Duration

F	PCLK Factor (Frames/ PCLK)	_ERR_DUR (Register 0x312, Bits[7:4]) Setting <sup>1</sup>
1	4	0 (default)
2	2	1
3	1.5	2
4	1	2
8	0.5	4

<sup>1</sup> These register settings assert the SYNCOUTx± signal for two frame clock cycle pulse widths.



## JESD204B SERIAL DATA INTERFACE

### Unexpected Control Character, NIT, Disparity IRQs

For UEK character, NIT, and disparity errors, error count over the threshold events are available as IRQ events. Enable these events by writing to Register 0x4B8, Bits[7:5]. The IRQ event status can be read at Register 0x4BA, Bits[7:5] after the IRQs are enabled.

See the [Error Counter and IRQ Control](#) section for information on resetting the IRQ. See the [Interrupt Request Operation](#) section for more information on IRQs.

### Errors Requiring Reinitializing

A link reinitialization automatically occurs when four invalid disparity characters or four NIT characters are received as per Section 7.1 of the JESD204B specification. When a link reinitialization occurs, the resync request is at least five frames and nine octets long.

The user can optionally reinitialize the link when the error count for disparity errors, NIT errors, or UEK character errors reaches a programmable error threshold. The process to enable the reinitialization feature for certain error types is as follows:

1. Choose and enable which errors to monitor by selecting them in Register 0x480, Bits[5:3] to Register 0x487, Bits[5:3]. UEK, BDE, and NIT error monitoring can be selected for each lane by writing a 1 to the appropriate bit, as described in [Table 33](#). These are enabled by default.
2. Write a 0 to the corresponding bit to Register 0x480, Bits[2:0] to Register 0x487, Bits[2:0] to take counter out of reset.
3. Enable the sync assertion mask for each type of error by writing to SYNC\_ASSERT\_MASK (Register 0x47D, Bits[2:0]) according to [Table 33](#).
4. Program the desired error counter threshold into ER-RORTHRES (Register 0x47C).
5. For each error type enabled in the SYNC\_ASSERT\_MASK register, if the error counter on any lane reaches the programmed threshold, SYNCOUT $x\pm$  falls, issuing a sync request. Note that all error counts are reset when a link reinitialization occurs. The IRQ does not reset and must be reset manually.

**Table 33. Sync Assertion Mask (SYNC\_ASSERT\_MASK)**

Addr.	Bit No.	Bit Name	Description
0x47D	2	BDE	Set to 1 to assert SYNCOUT $x\pm$ if the disparity error count reaches the threshold
	1	NIT	Set to 1 to assert SYNCOUT $x\pm$ if the NIT error count reaches the threshold
	0	UEK	Set to 1 to assert SYNCOUT $x\pm$ if the UEK character error count reaches the threshold

### CGS, Frame Sync, Checksum, and ILAS Monitoring

Register 0x470 to Register 0x473 can be monitored to verify that each stage of the JESD204B link establishment has occurred.

Bit x of CODE\_GRP\_SYNC (Register 0x470) is high if Link Lane x received at least four K28.5 characters and passed code group synchronization.

Bit x of FRAME\_SYNC (Register 0x471) is high if Link Lane x completed initial frame synchronization.

Bit x of GOOD\_CHECKSUM (Register 0x472) is high if the checksum sent over the lane matches the sum of the JESD204B parameters sent over the lane during ILAS for Link Lane x. The parameters can be added either by summing the individual fields in registers or summing the packed register. The calculated checksums are the lower eight bits of the sum of the following fields: DID, BID, LID, SCR, L - 1, F - 1, K - 1, M - 1, N - 1, SUBCLASSV, NP - 1, JESDV, S - 1, and HD.

Bit x of INIT\_LANE\_SYNC (Register 0x473) is high if Link Lane x passed the initial lane alignment sequence.

### CGS, Frame Sync, Checksum, and ILAS IRQs

Fail signals for CGS, frame sync, checksum, and ILAS are available as IRQ events. Enable them by writing to Register 0x4B8, Bits[3:0]. The IRQ event status can be read at Register 0x4BA, Bits[3:0] after the IRQs are enabled. Write a 1 to Register 0x4BA, Bit 0 to reset the CGS IRQ. Write a 1 to Register 0x4BA, Bit 1 to reset the frame sync IRQ. Write a 1 to Register 0x4BA, Bit 2 to reset the checksum IRQ. Write a 1 to Register 0x4BA, Bit 3 to reset the ILAS IRQ.

See the [Interrupt Request Operation](#) section for more information.

### Configuration Mismatch IRQ

The AD9172 has a configuration mismatch flag that is available as an IRQ event. Use Register 0x4B9, Bit 0 to enable the mismatch flag (it is enabled by default), and then use Register 0x4BB, Bit 0 to read back its status and reset the IRQ signal. See the [Interrupt Request Operation](#) section for more information.

The configuration mismatch event flag is high when the link configuration settings (in Register 0x450 to Register 0x45D) do not match the JESD204B settings received by the device (Register 0x400 to Register 0x40D).

This function is different from the good checksum flags in Register 0x472. The good checksum flags ensure that the transmitted checksum matches a calculated checksum based on the transmitted settings. The configuration mismatch event ensures that the transmitted settings match the configured settings.

**DIGITAL DATAPATH**

The full digital datapath of the AD9172 consists of channel datapaths that are bypassable, as well as a main DAC datapath leading up to the analog DAC core. There is a variety of different digital feature blocks available within each of the channel and main DAC datapaths.

**TOTAL DATAPATH INTERPOLATION**

The AD9172 contains two separate blocks of interpolation: one block is located in each of the channelizer datapaths, and a second interpolation stage is located in the main DAC datapath. The total interpolation for the chip can be determined by multiplying the channel interpolation factor by the main datapath interpolation factor. The relationship between the DAC sample rate and input data rate is shown in the following equation:

$$\text{Total Interpolation} = \text{Channel Interpolation} \times \text{Main Interpolation}$$

$$f_{\text{DATA}} = f_{\text{DAC}}(\text{Channel Interpolation} \times \text{Main Interpolation})$$

Each of the various cascaded half-band filters has 80% signal bandwidth capabilities. Therefore, if using interpolation (not bypass or 1x total interpolation for both channel and main datapaths), the available signal bandwidth (BW) with respect to the input data rate is calculated as follows:

$$\text{Signal BW} = 0.8 \times (f_{\text{DATA}}/2)$$

where the total interpolation > 1.

$$\text{Signal BW} = (f_{\text{DATA}}/2)$$

where the total interpolation = 1.

The interpolation values are programmed as shown in the [Table 34](#).

**Table 34. Interpolation Factor Register Settings**

Interpolation Factor	Main Datapath,	Channel Datapath,
	Register 0x111, Bits[7:4]	Register 0x111, Bits[3:0]
1x	0x1	0x1
2x	0x2	0x2
3x	Not applicable	0x3
4x	0x4	0x4
6x	0x6	0x6
8x	0x8	0x8
12x	0xC	Not applicable

**Table 35. Interpolation Modes and Useable Bandwidth**

Total Interpolation	Available Signal Bandwidth	f <sub>DATA</sub>
1x (Bypass)	f <sub>DATA</sub> /2	f <sub>DAC</sub>
2x, 4x, 6x, 8x, 12x, 16x, 18x, 24x, 32x, 36x, 48x, 64x	80% × f <sub>DATA</sub> /2	f <sub>DAC</sub> /total interpolation

**Filter Performance**

The interpolation filters interpolate between existing data in such a way that they minimize changes in the incoming data while suppressing the creation of interpolation images.

The usable bandwidth, as shown in [Table 35](#), is defined as the frequency band over which the filters have a pass-band ripple of less than ±0.001 dB and an image rejection of greater than 85 dB. Conceptual drawings that shows the relative bandwidth of each of the filters are shown in [Figure 62](#) and [Figure 63](#). The maximum pass-band amplitude of all filters is the same; they are different in the illustration to improve understanding.

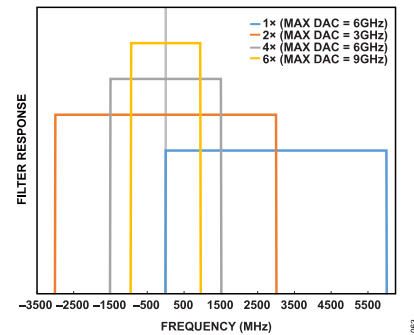

**Figure 62. Band Responses of Total Interpolation Rates for 1x, 2x, 4x, and 6x at Each Respective Maximum Achievable DAC Rate**

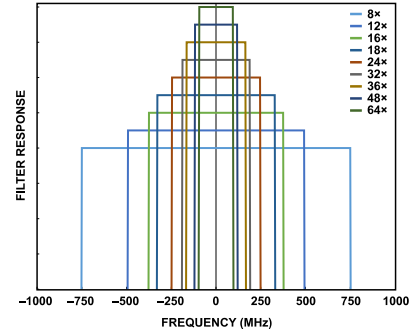

**Figure 63. Band Responses of Total Interpolation Rates for 8x, 12x, 16x, 18x, 24x, 32x, 36x, 48x, and 64x at a 12 GHz DAC Rate**

**NCO Only Mode**

The AD9172 is capable of operating in a mode with only the NCO enabled. In this mode, a single-tone sine wave is generated using a programmable internal dc amplitude level that is injected into the NCO block to modulate the data into a single tone. This internal dc level is injected into either the channel or main datapaths through various controls, as shown in [Figure 64](#). Mode 3 and Mode 4 can be used to generate a single-channel or dual channel NCO only mode of operation, respectively. It is not necessary to bring up the JESD204B link in this mode. This mode is a useful option to bring up a transmitter radio signal chain without requiring a digital data source, because the device generates the NCO data internally. This mode can also be used in applications where a sine wave is all

DIGITAL DATAPATH

that is required, such as in a local oscillator application. There is an additional optional calibration NCO block that can be used as part of the initial system calibration without needing to reprogram the final main datapath NCO to the final system configuration. This feature is discussed in more detail in the [Calibration NCO](#) section.

When the NCO test mode is enabled, the data source of the digital datapath is the dc test data word, meaning that the JESD204B link can be brought up and data can be transferred to the device

over the link, but the data is not presented to the DAC when in this test mode. Connection to the SERDES data source is only achieved by disabling this test mode. The SPI control bit for this test mode can be set on the fly, but because disabling the mode and switching to the SERDES datapath normally requires the lanes and/or interpolation mode to also be set, on the fly setting or resetting of the NCO only mode control bit is normally not practical.

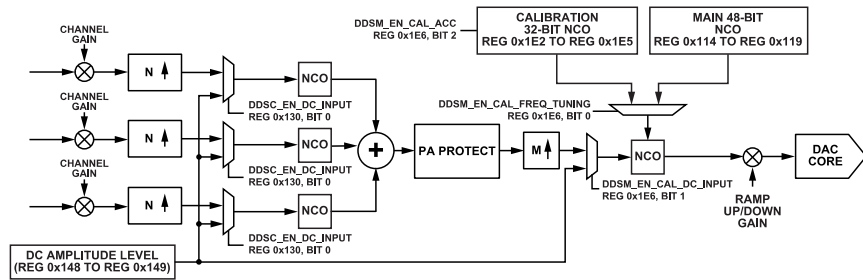

Figure 64. DC Amplitude Injection for NCO Only Mode Block Diagram

DIGITAL DATAPATH

CHANNEL DIGITAL DATAPATH

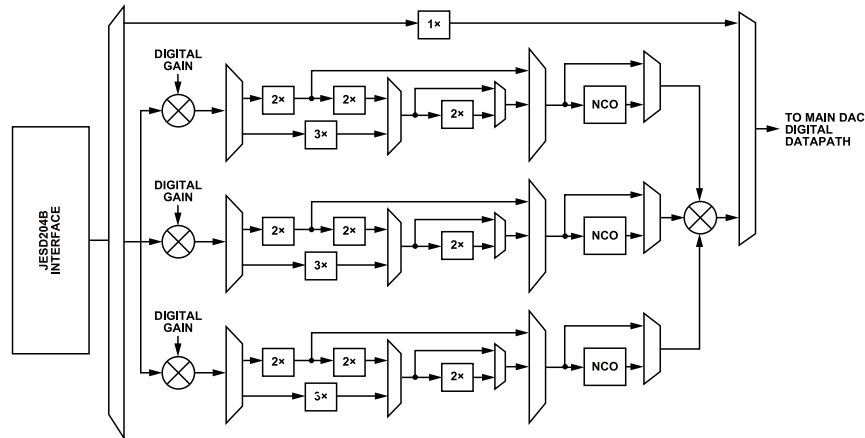

Figure 65. Block Diagram of the Channel Digital Datapath per the Main DAC Output

Each main DAC output has three optional channelizers, or channel datapaths, that are selected based on the JESD204B mode selected. The channel datapaths also have the option to be bypassed (1x interpolation selected), which bypasses all of the digital features included in each channelizer. Each channelizer consists of a digital gain stage, complex interpolation block, and complex 48-bit NCO with modulus. The interpolation selection is the same for all three channelizers; however, the gain stage and complex NCO values can all be independently configured. The controls for these blocks are paged by the channel paging mask in the CHANNEL\_PAGE bits (Register 0x008, Bits[5:0]), as described in Table 36. Each bit of the page mask corresponds to a channel datapath. These channels can be paged individually to set the values for each channel uniquely, or can be paged simultaneously to set all channels to the same value for the control being configured.

Table 36. Channel Page Mask

CHANNEL_PAGE (Register 0x008, Bits[5:0])	Channel Paged	Channel Datapath Updated
0x01 (Bit 0)	Channel 0	Channel 0 of DAC0
0x02 (Bit 1)	Channel 1	Channel 1 of DAC0
0x04 (Bit 2)	Channel 2	Channel 2 of DAC0
0x08 (Bit 3)	Channel 3	Channel 0 of DAC1
0x10 (Bit 4)	Channel 4	Channel 1 of DAC1
0x20 (Bit 5)	Channel 5	Channel 2 of DAC1

Each of the digital blocks in the channels is described in more detail in the following sections.

Digital Gain

The AD9172 has individual channel gain controls that allow unique gain scaling capabilities for each complex data input channel. The gain code for each channel is 12-bit resolution, located in Register 0x146 and Register 0x147, and can be calculated by the following formula:

$$0 \leq Gain \leq (2^{12} - 1)/2^{11}$$

$$-\infty \text{ dB} < \text{dBGain} \leq +6.018 \text{ dB}$$

$$Gain = \text{Gain Code} \times (1/2048)$$

$$\text{dBGain} = 20 \times \log_{10}(\text{Gain})$$

$$\text{Gain Code} = 2048 \times \text{Gain} = 2^{11} \times 10^{(\text{dBGain}/20)}$$

The gain code control (CHNL\_GAIN) is paged with the channel page mask (CHANNEL\_PAGE) in Register 0x008, Bits[5:0]. The digital gain feature is available in all modes, except when 1x channel interpolation is used because the channel datapaths are bypassed in that mode. The summing node that combines the three channels may clip the summed signals if the combined amplitude is too large. For example, if all three channels are being used and all three data streams are >1/3 full-scale amplitude, clipping may occur. The sum of the data values when any number of channels is used must be between  $-2^{15}$  and  $+2^{15}$ .

Channel Interpolation

The channel interpolation options available are bypass (1x), 2x, 3x, 4x, 6x, and 8x. Each of the half-band filters used for interpolation has 80% bandwidths with 85 dB of stop band rejection. The channel half-band cascaded configuration is shown in Figure 66, with each of the useable bandwidths of the channel interpolation filters listed in Table 37.

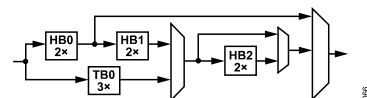

Figure 66. Channel Interpolation Half-Band Filter Block Diagram

Table 37. Channel Interpolation Useable Bandwidths and Rejection

Half-Band Filter	Bandwidth ( $\times f_{IN\_FILTER}$ ) (%)	Stop Band Rejection (dB)
HB0	80	85

## DIGITAL DATAPATH

Table 37. Channel Interpolation Useable Bandwidths and Rejection

Half-Band Filter	Bandwidth ( $\times f_{IN\_FILTER}$ ) (%)	Stop Band Rejection (dB)
TB0	54	85
HB1	40	85
HB2	27	85

## Channel Digital Modulation

The AD9172 has digital modulation features to modulate the base-band quadrature signal to a desired frequency. There are two stages of complex digital modulation available in the AD9172: channel modulation and main modulation. Each main DAC has three channels, each with its own NCO, that can individually modulate the data from each channel with a unique frequency and phase offset. The AD9172 is equipped with several NCO modes. The default NCO is a 48-bit, integer NCO. There is an additional modulus option for each channel NCO where the A/B ratio of the dual modulus NCO allows the output frequency to be synthesized with very fine precision. NCO mode is selected as shown in Table 38. These controls are paged per the channel page masks in the CHANNEL\_PAGE bits (Register 0x008, Bits[5:0]).

Table 38. Channel Modulation Mode Selection

Modulation Mode	Modulation Type	
	Register 0x130, Bit 6	Register 0x130, Bit 2
None	0b0	0b0
48-Bit Integer NCO	0b1	0b0
48-Bit Dual Modulus NCO	0b1	0b1

The channel NCO blocks also contain sideband selection controls as well as options for how the FTW and phase offset controls are updated.

Calculate the phase offset word control as follows:

$$-180^\circ \leq \text{Degrees Offset} \leq +180^\circ$$

$$\text{Degrees Offset} = 180^\circ \times (\text{DDSC\_NCO\_PHASE\_OFFSET}/2^{15})$$

where DDSC\_NCO\_PHASE\_OFFSET is a 16-bit twos complement value programmed in the registers listed in Table 39.

Table 39. Channel NCO Phase Offset Registers

Address	Value	Description
0x138	DDSC_NCO_PHASE_OFFSET[7:0]	8 LSBs of phase offset
0x139	DDSC_NCO_PHASE_OFFSET[15:8]	8 MSBs of phase offset

## 48-Bit Dual Modulus NCO

The 48-bit dual modulation mode uses an NCO, a phase shifter, and a complex modulator to modulate the signal by a programmable carrier signal, as shown in Figure 67. This configuration allows output signals to be placed anywhere in the output spectrum up to  $\pm f_{NCO}/2$  with very fine frequency resolution.

The NCO produces a quadrature carrier to translate the input signal to a new center frequency. A quadrature carrier is a pair of sinusoidal waveforms of the same frequency, offset 90° from each other. The frequency of the quadrature carrier is set via a FTW. The quadrature carrier is mixed with the I and Q data and then summed into the I and Q datapaths, as shown in Figure 67.

## Integer NCO Mode

The channel 48-bit NCOs can be used as integer NCOs. The FTW for the channel NCOs depends on the speed at which the channel NCO block is running ( $f_{NCO}$ ), which is the same rate as the summing node (maximum of 1.5 GSps) and can be calculated by using the following formulas:

$$f_{NCO} = f_{DATA} \times \text{Channel Interpolation}$$

or

$$f_{NCO} = f_{DAC}/\text{Main Interpolation} = f_{SUMMING\_NODE}$$

The FTWs for each individual channel can be programmed separately and are calculated by using the following formula:

$$-f_{NCO}/2 \leq f_{CARRIER} < +f_{NCO}/2$$

$$\text{DDSC\_FTW} = (f_{CARRIER}/f_{NCO}) \times 2^{48}$$

where DDSC\_FTW is a 48-bit, twos complement number.

The frequency tuning word is set as shown in Table 40.

Table 40. Channel NCO FTW Registers

Address	Value	Description
0x132	DDSC_FTW[7:0]	8 LSBs of FTW
0x133	DDSC_FTW[15:8]	Next 8 bits of FTW
0x134	DDSC_FTW[23:16]	Next 8 bits of FTW
0x135	DDSC_FTW[31:24]	Next 8 bits of FTW
0x136	DDSC_FTW[39:32]	Next 8 bits of FTW
0x137	DDSC_FTW[47:40]	8 MSBs of FTW

Unlike other registers, the FTW registers are not updated immediately upon writing. Instead, the FTW registers update on the rising edge of DDSC\_FTW\_LOAD\_REQ (Register 0x131, Bit 0). After an update request, DDSC\_FTW\_LOAD\_ACK (Register 0x131, Bit 1) must be high to acknowledge that the FTW has updated.

The DDSC\_SEL\_SIDE BAND bit (Register 0x130, Bit 1 = 0b1) is a convenience bit that can be set to use the lower sideband modulation result, which is equivalent to flipping the sign of the FTW.



## DIGITAL DATAPATH

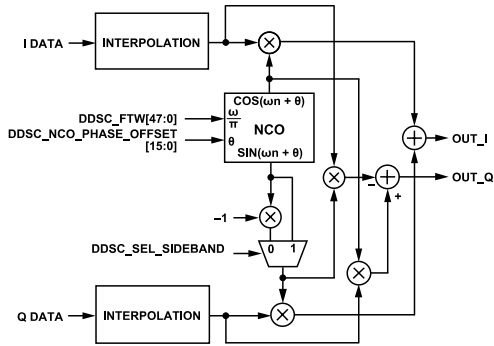

Figure 67. NCO Modulator Block Diagram

### Channel Modulus NCO Mode (Direct Digital Synthesis (DDS))

Each of the channel 48-bit NCOs can also be used in a dual modulus mode to create fractional frequencies beyond the 48-bit accuracy. The modulus mode is enabled by programming the DDSC\_MODULUS\_EN bit in the DDSC\_DATAPATH\_CFG register to 1 (Register 0x130, Bit 2 = 0b1).

The frequency ratio for the programmable modulus direct digital synthesis (DDS) is very similar to that of the typical accumulator-based DDS. The only difference is that N is not required to be a power of two for the programmable modulus, but can be an arbitrary integer. In practice, hardware constraints place limits on the range of values for N. As a result, the modulus extends the use of the NCO to applications that require exact rational frequency synthesis. The underlying function of the programmable modulus technique is to alter the accumulator modulus.

Implementation of the programmable modulus function within the AD9172 is such that the fraction, M/N, is expressible by the following equation. Note that the form of the equation implies a compound frequency tuning word with X representing the integer part and A/B representing the fractional part.

$$\frac{f_{CARRIER}}{f_{NCO}} = \frac{M}{N} = \frac{X + \frac{A}{B}}{2^{48}}$$

where:

X is programmed in Register 0x132 to Register 0x137.

A is programmed in Register 0x140 to Register 0x145.

B is programmed in Register 0x13A to Register 0x13F.

### Programmable Modulus Example

Consider the case in which  $f_{NCO} = 1500$  MHz and the desired value of  $f_{CARRIER}$  is 150 MHz. This scenario synthesizes an output frequency that is not a power of two submultiple of the sample rate, namely  $f_{CARRIER} = (1/10) f_{NCO}$ , which is not possible with a typical accumulator-based DDS. The frequency ratio,  $f_{CARRIER}/f_{DAC}$ , leads directly to M and N, which are determined by reducing the fraction (150,000,000/1,500,000,000) to its lowest terms, that is,

$$M/N = 150,000,000/1,500,000,000 = 1/10$$

Therefore, M = 1 and N = 10.

After calculation, X = 28,147,497,671,065, A = 3, and B = 5. Programming these values into the registers for X, A, and B (X is programmed in Register 0x132 to Register 0x137 for DDSC\_FTWM, B is programmed in Register 0x13A to Register 0x13F for DDSC\_ACC\_MODULUSx, and A is programmed in Register 0x140 to Register 0x145 for DDSC\_ACC\_DELTAx) causes the NCO to produce an output frequency of exactly 150 MHz given a 1500 MHz sampling clock. For more details, refer to the [AN-953 Application Note](#).

### NCO Reset

Resetting the NCO can be useful when determining the start time and phase of the NCO. The NCO can be reset by several different methods, including a SPI write or by the SYSREF± signal.

### Channel Summing Node

The channel datapaths all combine at the summing node junction before continuing on to the main DAC datapath. The summation of any number of channels being used must not exceed the  $\pm 2^{15}$  value range to avoid clipping of the data signal into the main datapath. The maximum data rate for each channel when the channel interpolation is  $>1\times$  is limited by the summing node junction maximum speed of 1.5 GSPS. If the channel data-paths are bypassed (channel interpolation is  $1\times$ ), the summing node block is also bypassed, as shown in [Figure 65](#).

## DIGITAL DATAPATH

## MAIN DIGITAL DATAPATH

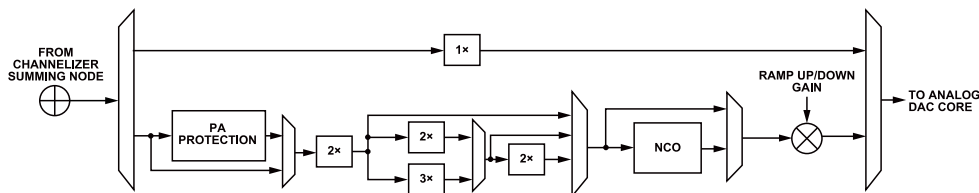

Figure 68. Block Diagram of the Main Digital Datapath per Main DAC Output

Each main DAC digital datapath consists of a power amplifier (PA) protection block, a complex main datapath interpolation block, a 48-bit complex main datapath NCO, and a ramp-up/ ramp-down gain block. The main DAC datapaths also have the option to be bypassed (1× interpolation selected), which bypasses all of the complex digital features included in the main digital datapath. The interpolation selection is set the same for all main datapaths; however, the PA protection block and complex NCO values can all be independently configured.

The controls for these blocks are paged by the main DAC datapath paging mask, MAINDAC\_PAGE (Register 0x008, Bits[7:6]), as listed in Table 41. Each bit of the page mask corresponds to a main DAC datapath. These datapaths can be paged individually to set the values for each DAC uniquely or can be paged simultaneously to set all channels to the same value for the control being configured.

Table 41. Main DAC Datapath Page Mask

MAINDAC_PAGE (Register 0x008, Bits[7:6])	DAC Paged	DAC Datapath Updated
0x40 (Bit 6)	DAC0	DAC0
0x80 (Bit 7)	DAC1	DAC1

Each of the digital blocks in the main datapaths is described in more detail in the following sections.

### Downstream Protection (PA Protection)

The AD9172 has several blocks designed to protect the PA of the system, as well as other downstream blocks, by preventing transients out of the DAC outputs. The DAC output can be triggered to turn on and off by the following signals, shown in Figure 69:

- ▶ PDP\_PROTECT. This signal asserts when the calculated digital vector power exceeds a programmable threshold.
- ▶ INTERFACE\_PROTECT. This signal asserts when certain JESD204B errors occur.
- ▶ SPI\_PROTECT. This signal asserts when the user writes the SPI trigger register control.
- ▶ BSM\_PROTECT. This signal asserts and the blanking state machine (BSM) module flushes the datapath on the rising edge of the TXEN0 or TXEN1 signals, which may come from a SPI write or the external TXEN0 or TXEN1 pin.

The flags of these events can also be routed out on the pins of IRQ ( $\overline{\text{IRQ0}}$  and  $\overline{\text{IRQ1}}$ ) to shut down other external downstream components. The DAC output on/off is implemented through a feedforward trigger signal to the ramp-up/ramp-down digital gain block at the end of the main digital datapath, before the analog DAC core, which allows the DAC to be turned on or off gradually with the ramp on/off block.

DIGITAL DATAPATH

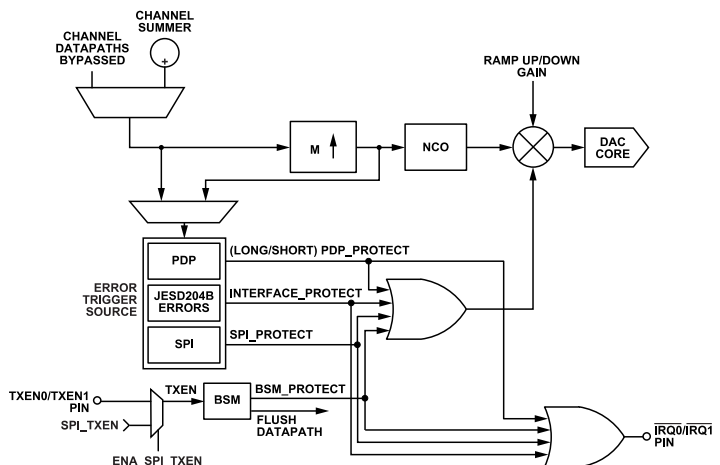

Figure 69. Block Diagram of Downstream Protection Triggers

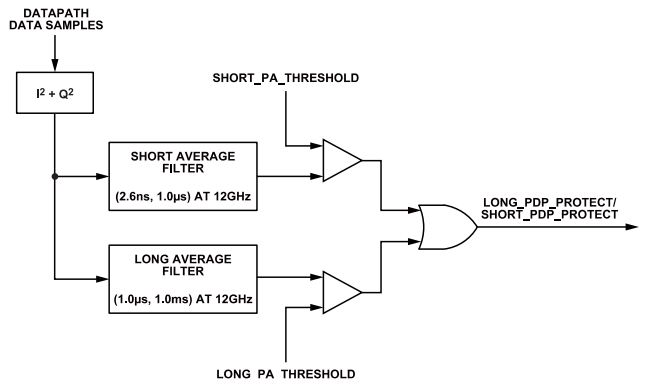

Figure 70. PDP Block Diagram

Power Detection and Protection (PDP) Block

The PDP block detects the average power of the DAC input signal and prevents overrange signals from being passed to the next stage, which may potentially cause destructive breakdown on power sensitive devices, such as PAs. The protection function provides a signal, PDP\_PROTECT, that can shut down the DAC outputs or be routed externally to shut down a PA.

The PDP block uses a separate path with a shorter latency than the datapath to ensure that PDP\_PROTECT is triggered before the overrange signal reaches the analog DAC cores (except when the total interpolation is 1x). The sum of the I<sup>2</sup> and Q<sup>2</sup> are calculated as a representation of the input signal power (only the top six MSBs of data samples are used). The calculated sample power numbers are accumulated through a moving average filter with an output that is the average of the input signal power in a certain number of samples. There are two types of average filters with different lengths: the short filter detects pulses with high power in the digital domain and the long filter detects high power in the digital domain, which lasts longer than the thermal constant of the PA.

When the output of the averaging filter is larger than the threshold, the internal signal, PDP\_PROTECT, goes high, which can optional-

ly be configured to trigger an IRQ flag and turn off the DAC output through the ramp-up/ramp-down.

The PDP block is configured as shown in Figure 70.

The long and short averaging time is configured by the LONG\_PA\_AVG\_TIME (Register 0x585, Bits [3:0]) and the SHORT\_PA\_AVG\_TIME (Register 0x58A, Bits [1:0]) controls. Use the following calculations to determine the average window size times:

$$\text{Length of long average window} = 2^{\text{LONG\_PP\_AVG\_TIME} + 9}$$

$$\text{Length of short average window} = 2^{\text{SHORT\_PA\_AVG\_TIME}}$$

When the average calculation value exceeds a specified threshold, the ramp-down signal is triggered to ramp down the output. The thresholds for the long and short average options are programmed in the registers listed in Table 42, along with their respective detected power calculation readbacks.

Table 42. PDP Threshold and Power Calculation Controls

Register	Bits	Control
0x583	[7:0]	LONG_PA_THRESHOLD[7:0]
0x584	[4:0]	LONG_PA_THRESHOLD[12:8]
0x586	[7:0]	LONG_PA_POWER[7:0]



## DIGITAL DATAPATH

Table 42. PDP Threshold and Power Calculation Controls

Register	Bits	Control
0x587	[4:0]	LONG_PA_POWER[12:8]
0x588	[7:0]	SHORT_PA_THRESHOLD[7:0]
0x589	[4:0]	SHORT_PA_THRESHOLD[12:8]
0x58B	[7:0]	SHORT_PA_POWER[7:0]
0x58C	[4:0]	SHORT_PA_POWER[12:8]

## Main Datapath Interpolation

The main digital datapath interpolation options available are bypass (1×), 2×, 4×, 6×, 8× and 12×. Each of the half-band filters used for interpolation have 80% bandwidths with 85 dB of stop band rejection. The channel half-band cascaded configuration is shown in Figure 71, with each of the useable bandwidths of the channel interpolation filters listed in Table 43.

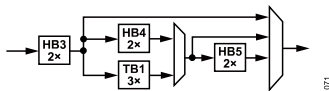

Figure 71. Main Datapath Interpolation Half-Band Filter Block Diagram

Table 43. Main Datapath Interpolation Useable Bandwidths and Rejection

Half-Band Filter	Bandwidth (×f <sub>IN_FILTER</sub> )	Stop Band Rejection (dB)
HB3	80%	85
HB4	40%	85
TB1	27%	85
HB5	20%	85

## Main Digital Modulation

The AD9172 has digital modulation features to modulate the baseband quadrature signal to a desired frequency. There are two stages of complex digital modulation available in the AD9172; channel modulation and main modulation. Each main DAC has a final main NCO that can individually modulate each main DAC datapath with a unique frequency and phase offset. The AD9172 is equipped with several NCO modes. The default NCO is a 48-bit, integer NCO. There is an additional modulus option for each main DAC datapath NCO where the A/B ratio of the dual modulus NCO allows the output frequency to be synthesized with very fine precision. NCO mode is selected as shown in Table 44. These controls are paged per the main DAC page masks, MAINDAC\_PAGE (Register 0x008, Bits [7:6]).

Table 44. Main Modulation Mode Selection

Modulation Mode	Modulation Type	
	Register 0x112, Bit 3	Register 0x112, Bit 2
None	0b0	0b0
48-Bit Integer NCO	0b1	0b0
48-Bit Dual Modulus NCO	0b1	0b1

The main NCO blocks also contain sideband selection controls as well as options for how the FTW and phase offset controls are updated.

Calculate the phase offset word control as follows:

$$-180^\circ \leq \text{Degrees Offset} \leq +180^\circ$$

$$\text{Degrees Offset} = 180^\circ \times (\text{DDSM\_NCO\_PHASE\_OFFSET} / 2^{15})$$

where *DDSM\_NCO\_PHASE\_OFFSET* is a 16-bit twos complement value programmed in the registers listed in Table 45.

Table 45. Main Datapath NCO Phase Offset Registers

Address	Value	Description
0x11C	DDSM_NCO_PHASE_OFFSET[7:0]	8 LSBs of phase offset
0x11D	DDSM_NCO_PHASE_OFFSET [15:8]	8 MSBs of phase offset

## 48-Bit Dual Modulus NCO

This modulation mode uses an NCO, a phase shifter, and a complex modulator to modulate the signal by a programmable carrier signal, as shown in Figure 67. This configuration allows output signals to be placed anywhere in the output spectrum up to  $\pm f_{\text{NCO}}/2$  with very fine frequency resolution.

The NCO produces a quadrature carrier to translate the input signal to a new center frequency. A quadrature carrier is a pair of sinusoidal waveforms of the same frequency, offset 90° from each other. The frequency of the quadrature carrier is set via a FTW. The quadrature carrier is mixed with the I and Q data and then summed into the I and Q datapaths, as shown in Figure 67.

## Integer NCO Mode

The channel 48-bit NCOs can be used as integer NCOs. The FTW for the channel NCOs depends on the speed at which the main NCO block is running ( $f_{\text{DAC}}$ ), which is the same rate as the DAC sample rate (12.6 GSPS, maximum) and can be calculated by using the following formula:

$$f_{\text{DAC}} = f_{\text{DATA}} \times \text{Channel Interpolation} \times \text{Main Interpolation}$$

The FTWs for each individual channel can be programmed separately and are calculated using the following formula:

$$-f_{\text{DAC}}/2 \leq f_{\text{CARRIER}} < +f_{\text{DAC}}/2$$

$$\text{DDSM\_FTW} = (f_{\text{CARRIER}} / f_{\text{DAC}}) \times 2^{48}$$

where *DDSM\_FTW* is a 48-bit, twos complement number.

The frequency tuning word is set as shown in Table 46.

Table 46. Main Datapath NCO FTW Registers

Address	Value	Description
0x114	DDSM_FTW[7:0]	8 LSBs of FTW
0x115	DDSM_FTW[15:8]	Next 8 bits of FTW
0x116	DDSM_FTW[23:16]	Next 8 bits of FTW
0x117	DDSM_FTW[31:24]	Next 8 bits of FTW

## DIGITAL DATAPATH

Table 46. Main Datapath NCO FTW Registers

Address	Value	Description
0x118	DDSM_FTW[39:32]	Next 8 bits of FTW
0x119	DDSM_FTW[47:40]	8 MSBs of FTW

Unlike other registers, the FTW registers are not updated immediately upon writing. Instead, the FTW registers update on the rising edge of DDSM\_FTW\_LOAD\_REQ (Register 0x113, Bit 0). After an update request, DDSM\_FTW\_LOAD\_ACK (Register 0x113, Bit 1) must be high to acknowledge that the FTW updated.

The DDSM\_SEL\_SIDE BAND bit (Register 0x112, Bit 1 = 0b1) is a convenience bit that can be set to use the lower sideband modulation result, which is equivalent to flipping the sign of the FTW.

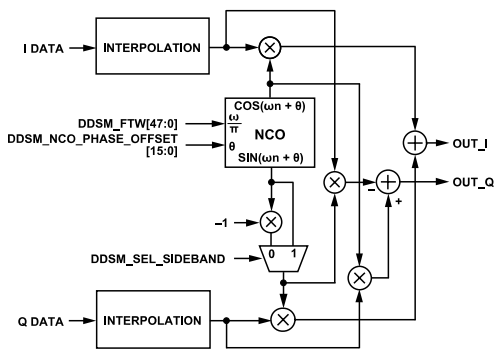

Figure 72. NCO Modulator Block Diagram

### Main Datapath Modulus NCO Mode (Direct Digital Synthesis (DDS))

Each of the main datapath 48-bit NCOs can also be used in a dual modulus mode to create fractional frequencies beyond the 48-bit accuracy. The modulus mode is enabled by programming the DDSM\_MODULUS\_EN bit in the DDSM\_DATAPATH\_CFG register to 1 (Register 0x112, Bit 2 = 0b1).

The frequency ratio for the programmable modulus DDS is very similar to that of the typical accumulator based DDS. The only difference is that N is not required to be a power of two for the programmable modulus, but can be an arbitrary integer. In practice, hardware constraints place limits on the range of values for N. As a result, the modulus extends the use of the NCO to applications that require exact rational frequency synthesis. The underlying function of the programmable modulus technique is to alter the accumulator modulus.

Implementation of the programmable modulus function within the AD9172 is such that the fraction, M/N, is expressible by the following equation. Note that the form of the equation implies a compound frequency tuning word with X representing the integer part and A/B representing the fractional part.

$$\frac{f_{CARRIER}}{f_{DAC}} = \frac{M}{N} = \frac{X + \frac{A}{B}}{2^{48}}$$

where:

X is programmed in Register 0x114 to Register 0x119.  
A is programmed in Register 0x12A to Register 0x12F.  
B is programmed in Register 0x124 to Register 0x129.

### Programmable Modulus Example

Consider the case in which  $f_{DAC} = 12$  GHz and the desired value of  $f_{CARRIER}$  is 1.2 GHz. This scenario synthesizes an output frequency that is not a power of two submultiple of the sample rate, namely  $f_{CARRIER} = (1/10) f_{NCO}$ , which is not possible with a typical accumulator based DDS. The frequency ratio,  $f_{CARRIER}/f_{DAC}$ , leads directly to M and N, which are determined by reducing the fraction (1,200,000,000/12,000,000,000) to its lowest terms, that is,

$$M/N = 1,200,000,000/12,000,000,000 = 1/10$$

Therefore, M = 1 and N = 10.

After calculation, X = 28,147,497,671,065, A = 3, and B = 5. Programming these values into the registers for X, A, and B (X is programmed in Register 0x114 to Register 0x119 for DDSM\_FTWx, B is programmed in Register 0x124 to Register 0x129 for DDSM\_ACC\_MODULUSx, and A is programmed in Register 0x12A to Register 0x12F for DDSM\_ACC\_DELTAx) causes the NCO to produce an output frequency of exactly 1.2 GHz given a 12 GHz sampling clock. For more details, refer to the [AN-953 Application Note](#).

### NCO Reset

Resetting the NCO can be useful when determining the start time and phase of the NCO. The NCO can be reset by several different methods, including via an SPI write or by the SYSREF± signal.

### Calibration NCO

There is an additional 32-bit calibration NCO option as part of the main DAC NCO block, shown in [Figure 64](#). Register 0x1E6, Bit 0 controls whether the 32-bit calibration NCO is in use in the main datapath, or if the normal 48-bit main NCO is used. First, enable the calibration NCO accumulator by setting Register 0x1E6, Bit 2 = 1. Then, program the calibration NCO FTW in Register 0x1E2 to Register 0x1E5 and update the FTW to take effect by toggling Register 0x113, Bit 0 from 0 to 1. Select the calibration NCO to be used instead of the main NCO by setting Register 0x1E6, Bit 0 = 1. If using the calibration NCO along with the internal dc amplitude level, enable the dc amplitude injection feature by setting Register 0x1E6, Bit 1 = 1.

### Modulator Switch

The final DAC NCO block has an added functionality of a modulator switch that allows the user to select the desired outputs of the NCO block. There are four mode functionalities available, as shown in [Figure 73](#) to [Figure 76](#). Some modes bypass the main datapath NCO for each DAC and use the complex I and Q data from each datapath, whereas other modes only use the I data output from

DIGITAL DATAPATH

each of the main datapath NCO blocks and select which DAC is used to output the data. These modes are programmed in Register

0x112, Bits[5:4] and are pagged by the MAINDAC\_PAGE register control.

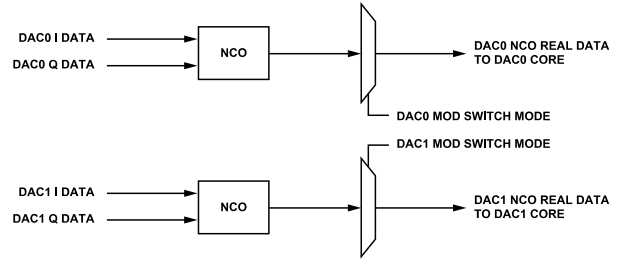

Figure 73. Mode 0—DAC0 = I0, DAC1 = I1

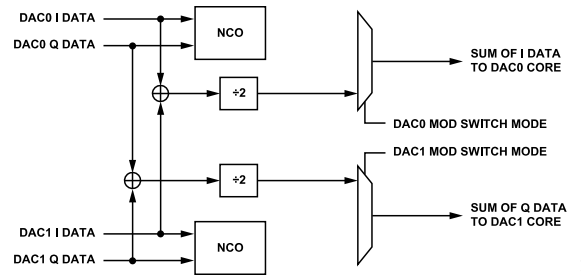

Figure 74. Mode 1—DAC0 = I0 + I1, DAC1 = Q0 + Q1

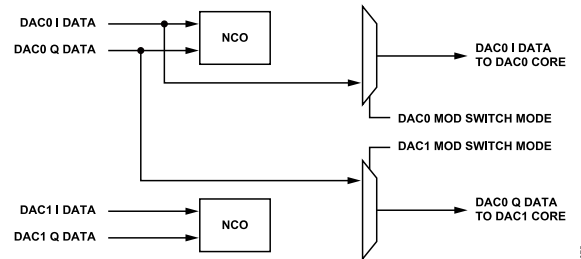

Figure 75. Mode 2—DAC0 = I0, DAC1 = Q0

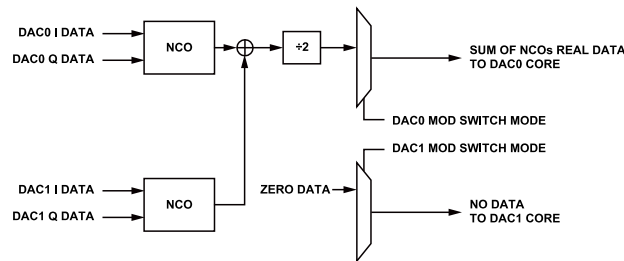

Figure 76. Mode 3—DAC0 = I0 + I1, DAC1 = 0

## DIGITAL DATAPATH

### Ramp Up/Down Gain

In each of the main datapaths, the ramp-up and ramp-down gain block is immediately before the digital datapath enters the analog DAC core for decoding. This block works in conjunction with the power detection and protection (PDP) block to protect any downstream components from large power peaks or long, high average power.

Various trigger signals can be configured in the PA protection block to trigger a gain ramp-down to mute the data being transmitted out of the DAC, as shown in [Figure 69](#). The ramp-up and ramp-down steps can be configured via the SPI in Register 0x580, Bits[2:0]. The equation for the ramp-up and ramp-down occurs in 32 steps over  $2^{(\text{CODE} + 8)}$  DAC clock periods. This control can be configured individually for each of the DAC ramp blocks via the MAINDAC\_PAGE control in Register 0x008.

After the data is ramped down from one of the triggers, it can be ramped back up in two of the following ways after the error condition is cleared. If the SPI protection control bit triggered the interrupt for a ramp-down, the SPI is then also used to ramp the data back up by toggling Register 0x582, Bit 7 from 0 to 1, and then back to 0.

Additionally, an option exists to mute the digital data during a digital clock rotation if the ROTATE\_SOFT\_OFF\_EN control in Register 0x581, Bit 2 is set to 1. When this bit is set, the synchronization logic rotation triggers the DAC ramp-down block, rotates the digital clocks, and ramps back up. These actions only occur if Bit 1 of the ROTATION\_MODE control in Register 0x03B is set to 1 to enable a datapath clock rotation when the synchronization logic rotates.

## INTERRUPT REQUEST OPERATION

The AD9172 provides an interrupt request output signal ( $\overline{IRQ}$ ) on Ball D9 ( $\overline{IRQ0}$ ) and Ball E9 ( $\overline{IRQ1}$ ) that can be used to notify an external host processor of significant device events. The  $\overline{IRQ}$  output can be switched between the  $\overline{IRQ0}$  pin or the  $\overline{IRQ1}$  pin by setting the corresponding bit for the signal in Register 0x028, Register 0x029, Register 0x02A, and Register 0x02B. Upon assertion of the interrupt, query the device to determine the precise event that occurred. The  $\overline{IRQx}$  pins are open-drain, active low outputs. Pull the  $\overline{IRQx}$  pins high, external to the device. These pins can be tied to the interrupt pins of other devices with open-drain outputs to wire; OR these pins together.

Figure 77 shows a simplified block diagram of how the  $\overline{IRQx}$  blocks works. If  $IRQ\_EN$  is low, the  $INTERRUPT\_SOURCE$  signal is set to 0. If  $IRQ\_EN$  is high, any rising edge of  $EVENT$  causes the  $INTERRUPT\_SOURCE$  signal to be set high. If any  $INTERRUPT\_SOURCE$  signal is high, the  $\overline{IRQx}$  pin is pulled low.  $INTERRUPT\_SOURCE$  can be reset to 0 by either an  $IRQ\_RESET$  signal or a  $DEVICE\_RESET$  signal.

Depending on the  $STATUS\_MODE$  signal,  $EVENT\_STATUS$  reads back an event signal or an  $INTERRUPT\_SOURCE$  signal. The AD9172 has several  $\overline{IRQ}$  register blocks that can monitor up to 86 events, depending on the device configuration. Certain details vary by  $\overline{IRQ}$  register block, as described in Table 47. Table 48 shows the source registers of the  $IRQ\_EN$ ,  $IRQ\_RESET$ , and  $STATUS\_MODE$

signals in Figure 77, as well as the address where  $EVENT\_STATUS$  is read back.

Table 47.  $\overline{IRQ}$  Register Block Details

Register Block	Event Reported	$EVENT\_STATUS$
0x020 to 0x27	Per chip	$INTERRUPT\_SOURCE$ if $IRQ$ is enabled; if not, it is an event
0x4B8 to 0x4BB; 0x470 to 0x473	Per link and lane	$INTERRUPT\_SOURCE$ if $IRQ$ is enabled; if not, 0

## INTERRUPT SERVICE ROUTINE

Interrupt request management starts by selecting the set of event flags that require host intervention or monitoring. Enable the events that require host action so that the host is notified when they occur. For events requiring host intervention upon  $\overline{IRQ}$  activation, run the following routine to clear an interrupt request:

1. Read the status of the event flag bits that are being monitored.
2. Disable the interrupt by writing 0 to  $IRQ\_EN$ .
3. Read the event source.
4. Perform any actions that may be required to clear the cause of the event. In many cases, no specific actions may be required.
5. Verify that the event source is functioning as expected.
6. Clear the interrupt by writing 1 to  $IRQ\_RESET$ .
7. Enable the interrupt by writing 1 to  $IRQ\_EN$ .

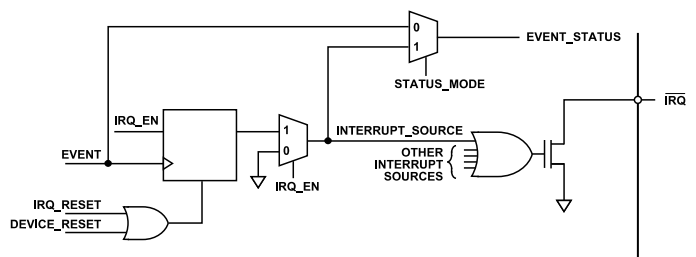

Figure 77. Simplified Schematic of  $\overline{IRQx}$  Circuitry

Table 48.  $\overline{IRQ}$  Register Block Address of  $\overline{IRQ}$  Signal Details

Register Block	Address of $IRQ$ Signals <sup>1</sup>			
	$IRQ\_EN$	$IRQ\_RESET$	$STATUS\_MODE$	$EVENT\_STATUS$
0x020 to 0x023	0x020 to 0x023; R/W per chip	0x024 to 0x027; per chip	$STATUS\_MODE = IRQ\_EN$	0x024 to 0x027; R per chip
0x4B8 to 0x4BB	0x4B8, 0x4B9; W per error type	0x4BA, 0x4BB; W per error type	Not applicable, $STATUS\_MODE = 1$	0x4BA, 0x4BB; W per chip
0x470 to 0x473	0x470 to 0x473; W per error type	0x470 to 0x473; W per link	Not applicable, $STATUS\_MODE = 1$	0x470 to 0x473; W per link

<sup>1</sup> R is read, W is write, and R/W is read/write.

## APPLICATIONS INFORMATION

### HARDWARE CONSIDERATIONS

#### Power Supply Recommendations

All the AD9172 supply domains must remain as noise free as possible for the best operation. Power supply noise has a frequency component that affects performance, and is specified in V rms.

An LC filter on the output of the power supply is recommended to attenuate the noise, and must be placed as close to the AD9172 as possible. The AVDD1.0 supply, which supplies the clock receiver and DAC analog core circuitry, and the AVDD1.8 supply, which powers the DAC output and DAC PLL blocks, are the most noise sensitive supplies on the device. It is highly recommended that AVDD1.0 and AVDD1.8 be supplied separately with ultralow noise regulators, such as the [ADP1763](#) and [ADM7154](#) or better to achieve the best phase noise performance possible. Noisier regulators impose phase noise onto the DAC output.

The DVDD1.0 supply provides power to the digital datapath blocks and the SVDD1.0 supply powers the SERDES circuitry on the chip. The DVDD1.8 supply powers circuitry blocks related to the SPI, SYNCOUTx± transmitter, SYSREF receiver, IRQx, RESET, and TXENx circuitry.

Take note of the maximum power consumption numbers shown in [Table 4](#) to ensure the power supply design can tolerate temperature and IC process variation extremes. The amount of current drawn is dependent on the chosen use cases, and specifications are provided for several use cases to illustrate examples and contributions from individual blocks, and to assist in calculating the maximum required current per supply.

Another consideration for the power supply design is peak current handling capability. The AD9172 draws more current in the main digital supply when synthesizing a signal with significant amplitude variations, such as a modulated signal, as compared to when in idle mode or synthesizing a dc signal. Therefore, the power supply must be able to supply current quickly to accommodate burst signals such as GSM, TDMA, or other signals that have an on or off time domain response. Because the amount of current variation depends on the signals used, it is best to perform lab testing first to establish ranges. A typical difference can be several hundred milliamperes.

#### Power and Ground Planes

Solid ground planes are recommended to avoid ground loops and to provide a solid, uninterrupted ground reference for the high speed transmission lines that require controlled impedances. It is recommended that power planes be stacked between ground layers for high frequency filtering. Doing so adds extra filtering and isolation between power supply domains in addition to the decoupling capacitors.

Do not use segmented power planes as a reference for controlled impedances unless the entire length of the controlled impedance

trace traverses across only a single segmented plane. These and additional guidelines for the topology of high speed transmission lines are described in the [JESD204B Serial Interface Inputs \(SERDIN0± to SERDIN7±\)](#) section.

For some applications, where highest performance and higher output frequencies are required, the choice of PCB materials significantly impacts results. For example, materials such as polyimide or materials from the Rogers Corporation can be used, for example, to improve tolerance to high temperatures and improve performance. Rogers 4350 material is used for the top three layers in some of the evaluation board designs: between the top signal layer and the ground layer below it.

#### JESD204B Serial Interface Inputs (SERDIN0± to SERDIN7±)

When considering the layout of the JESD204B serial interface transmission lines, there are many factors to consider to maintain optimal link performance. Among these factors are insertion loss, return loss, signal skew, and the topology of the differential traces.

#### Insertion Loss

The JESD204B specification limits the amount of insertion loss allowed in the transmission channel (see [Figure 48](#)). The AD9172 equalization circuitry allows significantly more loss in the channel than is required by the JESD204B specification. It is still important that the designer of the PCB minimize the amount of insertion loss by adhering to the following guidelines:

- ▶ Keep the differential traces short by placing the AD9172 as close to the transmitting logic device as possible and routing the trace as directly as possible between the devices.
- ▶ Route the differential pairs on a single plane using a solid ground plane as a reference. It is recommended to route the SERDES lanes on the same layer as the AD9172 to avoid vias being used in the SERDES lanes.
- ▶ Use a PCB material with a low dielectric constant (<4) to minimize loss, if possible.

When choosing between the stripline and microstrip techniques, keep in mind the following considerations: stripline has less loss (see [Figure 49](#) and [Figure 50](#)) and emits less EMI, but requires the use of vias that can add complexity to the task of controlling the impedance; whereas microstrip is easier to implement (if the component placement and density allow routing on the top layer) and eases the task of controlling the impedance.

If using the top layer of the PCB is problematic or the advantages of stripline are desirable, follow these recommendations:

- ▶ Minimize the number of vias.
- ▶ If possible, use blind vias to eliminate via stub effects and use microvias to minimize via inductance.



## APPLICATIONS INFORMATION

- ▶ If using standard vias, use the maximum via length to minimize the stub size. For example, on an 8-layer board, use Layer 7 for the stripline pair (see [Figure 78](#)).
- ▶ For each via pair, place a pair of ground vias adjacent to them to minimize the impedance discontinuity (see [Figure 78](#)).

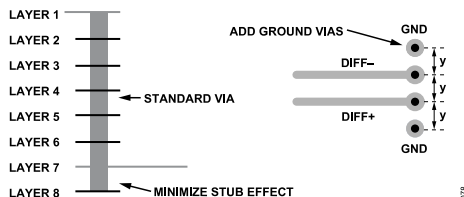

Figure 78. Minimizing Stub Effect and Adding Ground Vias for Differential Stripline Traces

## Return Loss

The JESD204B specification limits the amount of return loss allowed in a converter device and a logic device but does not specify return loss for the channel. However, make every effort to maintain a continuous impedance on the transmission line between the transmitting logic device and the AD9172. Minimizing the use of vias, or eliminating them entirely, reduces one of the primary sources for impedance mismatches on a transmission line (see the [Insertion Loss](#) section). Maintain a solid reference beneath (for microstrip) or above and below (for stripline) the differential traces to ensure continuity in the impedance of the transmission line. If the stripline technique is used, follow the guidelines listed in the [Insertion Loss](#) section to minimize impedance mismatches and stub effects.

Another primary source for impedance mismatch is at either end of the transmission line, where care must be taken to match the impedance of the termination to that of the transmission line. The AD9172 handles this matching internally with a calibrated termination scheme for the receiving end of the line. See the [Interface Power-Up and Input Termination](#) section for details on this circuit and the calibration routine.

## Signal Skew

There are many sources for signal skew, but the two sources to consider when laying out a PCB are interconnect skew within a single JESD204B link and skew between multiple JESD204B links. In each case, keeping the channel lengths matched to within 10 mm (calculated by  $12.5 \text{ mm} \times (12.5 \text{ Gbps}/15 \text{ Gbps})$ ) is adequate for operating the JESD204B link at speeds of up to 15 Gbps. This amount of channel length match is equivalent to about 85% UI on the AD9172 evaluation board. Managing the interconnect skew within a single link is straightforward. Managing multiple links across multiple devices is more complex. However, follow the 10 mm guideline for length matching. The AD9172 can handle more skew than the 85% UI due to the 6 PCLK buffer in the JESD204B receiver, but matching the channel lengths as close as possible is still recommended.

## Topology

Structure the differential SERDIN $\pm$  pairs to achieve 50  $\Omega$  to ground for each half of the pair. Stripline vs. microstrip trade-offs are described in the [Insertion Loss](#) section. In either case, it is important to keep these transmission lines separated from potential noise sources, such as high speed digital signals and noisy supplies. If using stripline differential traces, route them using a coplanar method, with both traces on the same layer. Although this method does not offer more noise immunity than the broadside routing method (traces routed on adjacent layers), it is easier to route and manufacture so that the impedance continuity is maintained. Broadside vs. coplanar differential Tx lines are shown in [Figure 79](#).

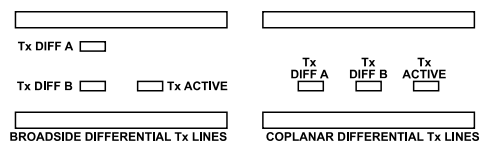

Figure 79. Broadside vs. Coplanar Differential Stripline Routing Techniques

When considering the trace width vs. copper weight and thickness, the speed of the interface must be considered. At multigigabit speeds, the skin effect of the conducting material confines the current flow to the surface. Maximize the surface area of the conductor by making the trace width wider to reduce the losses. Additionally, loosely couple differential traces to accommodate the wider trace widths. This coupling helps reduce the crosstalk and minimize the impedance mismatch when the traces must separate to accommodate components, vias, connectors, or other routing obstacles. Tightly coupled vs. loosely coupled differential traces are shown in [Figure 80](#).

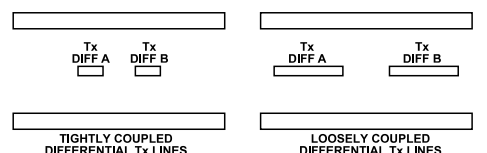

Figure 80. Tightly Coupled vs. Loosely Coupled Differential Traces

## AC Coupling Capacitors

The AD9172 requires that the JESD204B input signals be ac-coupled to the source. These capacitors must be 100 nF and placed as close as possible to the transmitting logic device. To minimize the impedance mismatch at the pads, select the package size of the capacitor so that the pad size on the PCB matches the trace width as closely as possible.

## SYNCOUT $\pm$ , SYSREF $\pm$ , and CLK $\pm$ Signals

The SYSREF $\pm$  signal on the AD9172 is a low speed, LVDS, differential signal. The SYNCOUT $\pm$  signals are LVDS or CMOS selectable. When LVDS mode is selected, use controlled impedance traces routed as 100  $\Omega$  differential impedance and 50  $\Omega$  to ground when routing these signals. As with the SERDIN0 $\pm$  to SERDIN7 $\pm$

**APPLICATIONS INFORMATION**

data pairs, it is important to keep these signals separated from potential noise sources, such as high speed digital signals and noisy supplies. Separate the  $\overline{\text{SYNCOUTx}}_{\pm}$  signal from other noisy signals because noise on the  $\overline{\text{SYNCOUTx}}_{\pm}$  may be interpreted as a request for /K/ characters. It is important to keep similar trace

lengths for the  $\text{CLK}_{\pm}$  and  $\text{SYSREF}_{\pm}$  signals from the clock source to each of the devices on either end of the JESD204B links (see [Figure 81](#)). If using a clock chip that can tightly control the phase of  $\text{CLK}_{\pm}$  and  $\text{SYSREF}_{\pm}$ , the trace length matching requirements are greatly reduced.

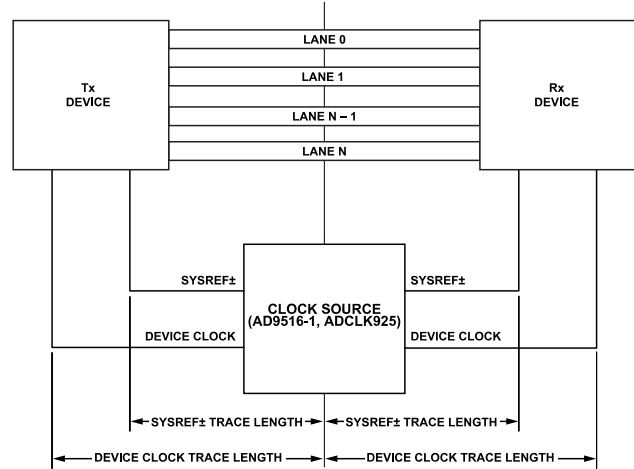

**Figure 81. SYSREF± Signal and Device Clock Trace Length**



**ANALOG INTERFACE CONSIDERATIONS**

**DAC INPUT CLOCK CONFIGURATIONS**

The AD9172 DAC sample clock or device clock (DACCLK) can be sourced directly through CLKIN± (Pin H12 and Pin J12) or by using the on-chip, integrated, integer PLL VCO with the same CLKIN± differential input serving as the reference. Clock multiplying employs the on-chip DAC PLL that accepts a reference clock operating at a submultiple of the desired DACCLK rate. The PLL then multiplies the reference clock up to the desired DACCLK frequency, which generates all the clocks within the AD9172, as shown in Figure 84.

The AD9172 contains a low jitter, differential clock receiver that is capable of interfacing directly to a differential or single-ended clock source. Because the input is self biased with a nominal impedance of 100 Ω, it is recommended that the clock source be ac-coupled to the CLKIN± input pins. Improved phase noise performance can be achieved with a higher clock input level. The quality of the clock source, as well as its interface to the AD9172 clock input, directly impacts ac performance. Select the phase noise and spur characteristics of the clock source to meet the target application requirements.

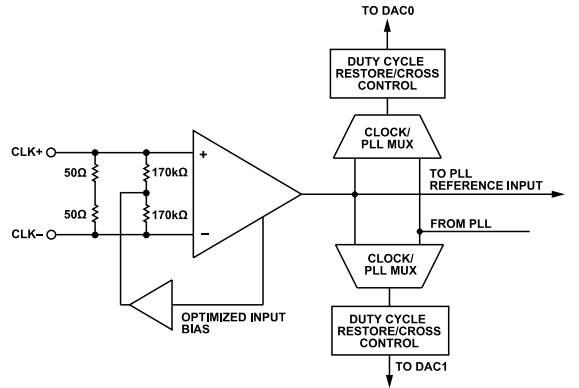

Figure 82. Clock Receiver Input Simplified Equivalent Circuit

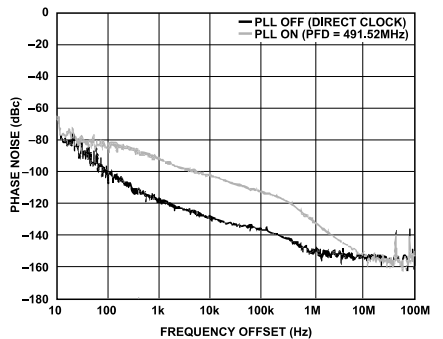

Figure 83. Phase Noise vs. Frequency Offset; Direct Clock and PLL Phase Noise, 12 GHz DAC Sample Rate, 1.65 GHz Output Frequency

## ANALOG INTERFACE CONSIDERATIONS

## DAC On-Chip PLL

When using the on-chip PLL, the predivider setting is selected (via Register 0x793, Bits[1:0]) to divide the clock receiver frequency internally to be within the range of 25 MHz to 770 MHz for the phase frequency detector (PFD) circuitry block input.

The AD9172 DAC VCO operates over a frequency range of 8.74 GHz to 12.4 GHz. Enable the DAC PLL synthesizer by setting Register 0x095, Bit 0 to 0. The DAC clock rate is user configurable to be the VCO frequency (8.74 GHz to 12.4 GHz), the VCO frequency divided by 2 (4.37 GHz to 6.2 GHz), or the VCO frequency divided by 3 (2.92 GHz to 4.1 GHz) by setting Register 0x094, Bits[1:0]. See the Startup sequence section for instructions on how to program the PLL.

The AD9172 DAC PLL requires an external loop filter. The recommended filter is a standard passive filter, as shown in Figure 84. The user can customize the filter according to the PFD frequency, reference clock phase noise, and DAC output phase noise requirements. For lowest jitter applications, use the highest possible PFD frequency to minimize the contribution of in-band noise from the PLL. However, when operating with a VCO frequency from 9.96 GHz to 10.87 GHz, set the PFD frequency to less than 225

MHz to ensure optimized stability over temperature. Set the PLL filter bandwidth such that the in-band noise of the PLL intersects with the open-loop noise of the VCO, minimizing the contribution of both to the overall noise.

The DAC PLL uses an integer type synthesizer to achieve the DAC sampling clock. The relation between DAC clock and the reference clock is as follows:

$$f_{DAC} = (8 \times N \times f_{REF}) / (M \cdot (\text{Register } 0x094, \text{ Bits}[1:0] + 1))$$

where:

$f_{DAC}$  is the desired DAC clock rate.

$N$  is the VCO feedback divider ratio, ranging from 2 to 50.

$f_{REF}$  is the reference clock.

$M$  is the reference clock divider ratio; the valid values for reference clock divider (predivider) are 1, 2, 3, or 4 by setting Register 0x793, Bits[1:0].

The VCO automatic calibration is triggered by the falling edge of Register 0x792, Bit 1 transitioning from a logic high to logic low. A lock detector bit (Register 0x7B5, Bit 0) is provided to indicate that the DAC PLL achieved lock. If Register 0x7B5, Bit 0 = 1, the PLL has locked.

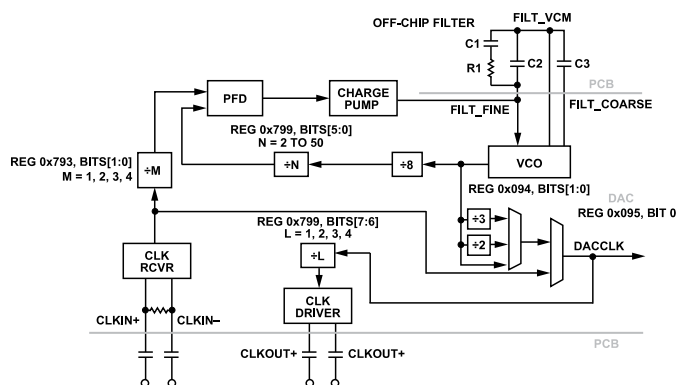

Figure 84. DAC PLL and Clock Path Block Diagram

## ANALOG INTERFACE CONSIDERATIONS

### CLOCK OUTPUT DRIVER

The AD9172 is capable of generating and outputting a high performance divide down clock that can be used to clock a companion analog-to-digital converter (ADC). The integer clock divider supports divide ratios 1, 2, 3, and 4 and can be programmed by Register 0x799, Bits[7:6] to set the desired output frequency. The output frequency ranges from 727.5 MHz to 3 GHz.

### ANALOG OUTPUTS

The AD9172 provides complementary current outputs, DAC0± and DAC1±. Figure 85 shows an equivalent output circuit for the DAC. The AD9172 features an internal 100 Ω termination resistor ( $R_{INT}$ ) that eliminates the need to terminate the DAC current output externally on the PCB board. Two RF chokes, one for each DAC output leg, are required to provide a dc current path for the DAC output. The value of the choke depends on the desired output frequency range. In general, a larger choke provides a lower cutoff output frequency. A 2:1 balun is recommended to transform the differential DAC output to a single-ended signal. A 2:1 balun is recommended to transform the differential DAC output to a single-ended signal.

$I_{OUTFS}$  is the full-scale current of each of the two DAC outputs. It is an 8-bit value stored in Register 0x05A. The full-scale current of the DAC is typically 19.531 mA. The DAC full-scale current can be adjusted from 15.625 mA to 25.977 mA by programming the appropriate value in Register 0x05A.

$$I_{OUTFS} = 15.625 \text{ mA} + FSC\_CTRL \times (25/256) \text{ (mA)}$$

The example shown in Figure 85 can be modeled as a pair of dc current sources that source half of the  $I_{OUTFS}$  current to each output. This differential ac current source models the signal (that is, a digital code) dependent nature of the DAC output.

The ac differential current measured at DACx+ and DACx- is as follows:

$$I_{AC\_DIFF} \text{ (mA)} = \frac{DACCODE}{DACCODEMAX} \times I_{OUTFS} \times \frac{R_{INT} R_{LOAD}}{R_{INT} + R_{LOAD}}$$

where:

$DACCODE = 0$  to 65,535 (decimal).

$R_{LOAD}$  is the load impedance seen on DACx+ and DACx-.

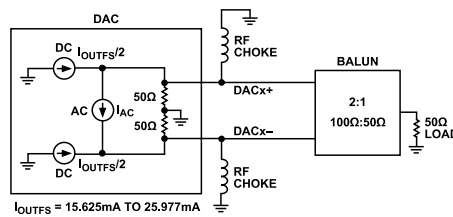

Figure 85. Equivalent DAC Output Circuit and Recommended DAC Output Network

## START-UP SEQUENCE

Several steps are required to program the AD9172 to the proper operating state after the device is powered up. This sequence is divided into several steps, and is listed in [Table 49](#) to [Table 58](#), along with an explanation of the purpose of each step. Private

registers are reserved but must be written for proper operation. Blank cells or cells with a variable or bit field name (in all capital letters) in [Table 49](#) to [Table 58](#) indicate that the value depends on the result as described in the Description column.

**Table 49. Power-Up and Required Register Writes**

R/W	Register	Bits	Value	Description
W	0x000	[7:0]	0x81	Soft reset.
W	0x000	[7:0]	0x3C	Release reset and set to 4-wire SPI (optional; leave at the default of the 3-wire SPI).
W	0x091	[7:0]	0x00	Power up clock receiver.
W	0x206	[7:0]	0x01	Take PHYs out of reset.
W	0x705	[7:0]	0x01	Enable boot loader.
	Pause			Wait 1 ms.
W	0x090	[7:0]	0x00	Power on DACs and bias circuitry.

**Table 50. DAC PLL Configuration**

R/W	Register	Bits	Value	Description
W	0x095	[7:0]	0x00 or 0x01	Bypass PLL. Set to 0x00 to use internal DAC PLL. If the user plans to supply the DAC clock directly, set this register to 0x01 and execute the following two register writes; then, skip the remaining writes in this table.
W	0x790	[7:0]	0xFF or 0x00	Write this register to 0xFF if bypassing the PLL (Register 0x095 = 0x01). If using the PLL, write this register to 0x00.
W	0x791	[7:0]	0x1F or 0x00	Write this register to 0xFF if bypassing the PLL (Register 0x095 = 0x01) and then skip the remaining register writes in this table and continue to <a href="#">Table 51</a> . If using the PLL, write this register to 0x00 as well as the remainder of the register writes in this table.
W	0x796	[7:0]	0xE5	DAC PLL required write.
W	0x7A0	[7:0]	0xBC	DAC PLL required write.
W	0x794	[5:0]	DACPLL_CP	Set DAC PLL charge pump current. The recommended setting is 0x08, but can range from 0x04 to 0x10 for different phase noise performance targets.
W	0x797	[7:0]	0x10	DAC PLL required write.
W	0x797	[7:0]	0x20	DAC PLL required write.
W	0x798	[7:0]	0x10	DAC PLL required write.
W	0x7A2	[7:0]	0x7F	DAC PLL required write.
	Pause			Wait 100 ms.
W	0x799	[7:6]	ADC_CLK_DIVIDER	DAC PLL divider settings. ADC driver/clock output divide ratio. 0b00 = ÷1. 0b01 = ÷2. 0b10 = ÷3. 0b11 = ÷4.
		[5:0]	N_DIVIDER	Programmable N divider. $N\_DIVIDER = (f_{DAC} \times M\_DIVIDER) / (8 \times \text{reference clock})$ .
W	0x793	[7:2]	0x06	DAC PLL divider settings. Keep default value for these bits.
		[1:0]	M_DIVIDER-1	Programmable predivider M_DIVIDER-1 (in n - 1 notation). The relevant calculation is as follows: PFD Frequency = reference clock/M_DIVIDER, where 25 MHz ≤ PFD frequency ≤ 770 MHz. If 9.96 GHz ≤ PLL VCO frequency ≤ 10.87 GHz, must keep 25 MHz ≤ PFD frequency ≤ 225 MHz. 0b00 = ÷1. 0b01 = ÷2. 0b10 = ÷3. 0b11 = ÷4.
W	0x094	[7:2]	0x00	Keep default value for these bits.
		1	PLL_VCO_DIV3_EN	Enable PLL output clock to be divided by 3. If this bit is set to 1, DAC clock = PLL VCO frequency/3.

## START-UP SEQUENCE

Table 50. DAC PLL Configuration

R/W	Register	Bits	Value	Description
		0	PLL_VCO_DIV2_EN	Enable PLL output clock to be divided by 2. Either this bit or Bit 1 in this register can be set to 1, but both bits cannot be set at the same time (there is no divide by 6 option). 0b0: DAC clock = PLL VCO frequency. 0b1: DAC clock = PLL VCO frequency/2.
W	0x792	[7:0]	0x02	Reset VCO.
W	0x792	[7:0]	0x00	
	Pause			Wait 100 ms for PLL to lock.
R	0x7B5	0	0b1	Ensure PLL is locked by reading back a value of 1 for bit 0 of this register.

Table 51. Delay Lock Loop (DLL) Configuration

R/W	Register	Bits	Value	Description
W	0x0C0	[7:0]	0x00	Power-up delay line.
W	0x0DB	[7:0]	0x00	
W	0x0DB	[7:0]	0x01	Update DLL settings to circuitry.
W	0x0DB	[7:0]	0x00	
W	0x0C1	[7:0]	0x68 or 0x48	Set DLL search mode. If $f_{DAC}$ is < 4.5 GHz, set this register to 0x48. Otherwise, set this register to 0x68.
W	0x0C1	[7:0]	0x69 or 0x49	Set DLL search mode. If $f_{DAC}$ is < 4.5 GHz, set this register to 0x49. Otherwise, set this register to 0x69.
W	0x0C7	[7:0]	0x01	Enable DLL read status.
R	0x0C3	0	0b1	Ensure DLL is locked by reading back a value of 1 for Bit 0 of this register.

Table 52. Calibration

R/W	Register	Bits	Value	Description
W	0x050	[7:0]	0x2A	Optimized calibration setting register write.
W	0x061	[7:0]	0x68	Required calibration control register write.
W	0x051	[7:0]	0x82	Optimized calibration setting register write.
	Pause			Wait 1 ms.
W	0x051	[7:0]	0x83	Required calibration control register write.
W	0x081	[7:0]	0x03	Required calibration control register write.

Table 53. JESD204B Mode Setup

R/W	Register	Bits	Value	Description
W	0x100	[7:0]	0x00	Power up digital datapath clocks when internal clocks are stable.
W	0x110	[5:0]	JESD_MODE	Bit 5 of the JESD_MODE bit field determines whether the device is operating in single link or dual link modes. 0 = single-link mode; 1 = dual-link mode. Bits[4:0] determine the SERDES JESD204B mode of operation chosen from the appropriate single-link or dual-link modes in Table 15 or Table 16.
W	0x111	[7:4]	DP_INTERP_MODE	Main datapath interpolation mode. The valid interpolation options for this control is based on the JESD_MODE selected in Register 0x110. Bit 7 of Register 0x110 equals 1 if the JESD_MODE, DP_INTERP_MODE, and CH_INTERP_MODE settings are not a valid combination.
		[3:0]	CH_INTERP_MODE	Channel datapath interpolation mode. The valid interpolation options for this control is based on the JESD_MODE selected in Register 0x110. Bit 7 of Register 0x110 equals 1 if the JESD_MODE, DP_INTERP_MODE, and CH_INTERP_MODE settings are not a valid combination.
W	0x084	6	SYSREF_INPUTMODE	SYSREF± signal input mode selection. 0b0 = ac-coupled. 0b1 = dc-coupled.
		0	SYSREF_PD	If using Subclass 0, this bit can be set to 1 to power down the SYSREF± receiver. If using Subclass 1, keep at the default of 0.
W	0x312	[7:4]		Set error duration, depending on the selected mode.
W	0x300	3	LINK_MODE	Corresponds to the mode selection made in Register 0x110. 0b0 = single-link mode.

## START-UP SEQUENCE

Table 53. JESD204B Mode Setup

R/W	Register	Bits	Value	Description
				0b1 = dual-link mode.
		2	0b0	Select Link 0 for setup. This bit selects the link QBD being paged. 0b0 = Link 0 (QBD0). 0b1 = Link 1 (QBD1).
		[1:0]	0b00	Keep links disabled until end of routine.
W	0x475	[7:0]	0x09	Soft reset the JESD204B quad-byte deframer.
W	0x453	7	SCR	Set scrambling option for SERDES data. 0 = disable scrambling. 1 = enable scrambling.
		[4:0]	L-1	Write the L value (in n - 1 notation) for the selected JESD_MODE.
W	0x458	[7:5]	SUBCLASSV	For Subclass 0, set this bit to 0. For Subclass 1, set this bit to 1.
		[4:0]	NP-1	Write the NP value (in n - 1 notation) for the selected JESD_MODE.
W	0x475	[7:0]	0x01	Bring the JESD204B quad-byte deframer out of reset.
W	0x300			If running in dual link mode, repeat writes for Link 1 as follows. If running in single-link mode, skip the remaining steps in this table.
		3	LINK_MODE	Corresponds to the mode selection made in Register 0x110. 0b0 = single-link mode. 0b1 = dual link mode.
		2	0b1	Select Link 1 for setup. This bit selects which link QBD is being paged. 0b0 = Link 0 (QBD0). 0b1 = Link 1 (QBD1).
		[1:0]	0b00	Keep links disabled until end of routine.
W	0x475	[7:0]	0x09	Soft reset the JESD204B quad-byte deframer.
W	0x453	7	SCR	Set scrambling option for SERDES data. 0 = disable scrambling. 1 = enable scrambling.
W	0x458	[4:0]	L-1	Write the L value (in n - 1 notation) for the selected JESD_MODE.
		[7:5]	SUBCLASSV	For Subclass 0, set this bit to 0. For Subclass 1, set this bit to 1.
		[4:0]	NP-1	Write the NP value (in n - 1 notation) for the selected JESD_MODE.
W	0x475	[7:0]	0x01	Bring the JESD204B quad-byte deframer out of reset.

Table 54 lists optional registers to configure the channel datapaths if they are being configured for a specific application. If the channel datapaths are bypassed (CH\_INTERP\_MODE = 1 for 1× channel interpolation), Table 54 can be skipped in the start-up sequence.

Table 54. Channel Datapath Setup: Digital Gain and Channel NCOs

R/W	Register	Bits	Value	Description
W	0x008	[5:0]		CHANNEL_PAGE. Select the channels to be programmed at the same time (or repeat this block for each channel to independently program values). Bit x of this control corresponds to the Channel x datapath.
W	0x146	[7:0]		CHNL_GAIN[7:0]. Write LSBs of channel digital gain. Configure digital gain for selected channels in Paging Register 0x008. Calculation: $CHNL\_GAIN = 2^{11} \times 10(dBGain/20)$ where dBGain is the gain value in dB for the channel gain desired.
W	0x147	[7:0]		CHNL_GAIN[11:8]. Write MSBs of channel digital gain. Calculations shown in Register 0x146.
W	0x130	6		Enable NCO for selected channels in paging Register 0x008. 0b0 = disable NCO. 0b1 = enable NCO.
		2		Enable NCO modulus for selected channels in paging Register 0x008. 0b0 = disable NCO modulus. 0b1 = enable NCO modulus.
		1		Select sideband from modulation result.

## START-UP SEQUENCE

Table 54. Channel Datapath Setup: Digital Gain and Channel NCOs

R/W	Register	Bits	Value	Description
				0b0 = upper sideband. 0b1 = lower sideband (spectral flip).
		0		If dc test mode or NCO test mode is desired, set this bit to 1 to enable the test tone generation. Otherwise, set this bit to the default value of 0. Integer NCO mode calculation: $DDSC\_FTW = (f_{CARRIER}/f_{NCO}) \times 2^{48}$ , where $f_{NCO} = f_{DATA}/CH\_INTERP\_MODE$ .
W	0x132	[7:0]		Write DDSC_FTW[7:0].
W	0x133	[7:0]		Write DDSC_FTW[15:8].
W	0x134	[7:0]		Write DDSC_FTW[23:16].
W	0x135	[7:0]		Write DDSC_FTW[31:24].
W	0x136	[7:0]		Write DDSC_FTW[39:32].
W	0x137	[7:0]		Write DDSC_FTW[47:40].
W	0x138	[7:0]		Write DDSC_NCO_PHASE_OFFSET[7:0]. Calculation: $DDSC\_NCO\_PHASE\_OFFSET = (Degrees\ Offset/180) \times 2^{15}$ .
W	0x139	[7:0]		Write DDSC_NCO_PHASE_OFFSET[15:8]. If using NCO modulus mode, also program modulus parameters. If not, skip this section. For modulus NCO mode: $(f_{CARRIER}/f_{NCO}) = (X + (A/B))/2^{48}$ where $DDSC\_ACC\_DELTA = A$ , $DDSC\_ACC\_MODULUS = B$ , and $DDSC\_FTW = X$ .
W	0x13A	[7:0]		Write DDSC_ACC_MODULUS[7:0].
W	0x13B	[7:0]		Write DDSC_ACC_MODULUS[15:8].
W	0x13C	[7:0]		Write DDSC_ACC_MODULUS[23:16].
W	0x13D	[7:0]		Write DDSC_ACC_MODULUS[31:24].
W	0x13E	[7:0]		Write DDSC_ACC_MODULUS[39:32].
W	0x13F	[7:0]		Write DDSC_ACC_MODULUS[47:40].
W	0x140	[7:0]		Write DDSC_ACC_DELTA[7:0].
W	0x141	[7:0]		Write DDSC_ACC_DELTA[15:8].
W	0x142	[7:0]		Write DDSC_ACC_DELTA[23:16].
W	0x143	[7:0]		Write DDSC_ACC_DELTA[31:24].
W	0x144	[7:0]		Write DDSC_ACC_DELTA[39:32].
W	0x145	[7:0]		Write DDSC_ACC_DELTA[47:40].
W	0x131	0	0b1	Update all NCO phase and FTW words.

Table 55 lists optional registers to configure the main DAC datapaths if they are being configured for a specific application. If the main DAC datapaths are bypassed ( $DP\_INTERP\_MODE = 1$  for 1× channel interpolation), Table 55 can be skipped in the start-up sequence.

Table 55. Main DAC Datapath Setup: PA Protect and Main NCOs

R/W	Register	Bits	Value	Description
W	0x008	[7:6]		MAINDAC_PAGE. Select the main DAC datapath to be programmed at the same time (or repeat this block for each DAC datapath to independently program values). Bit x of this control corresponds to the DAC x datapath.
W	0x112	3		Enable NCO for selected channels in paging Register 0x008. 0b0 = disable NCO. 0b1 = enable NCO.
		2		Enable NCO modulus for selected channels in paging Register 0x008. 0b0 = disable NCO modulus. 0b1 = enable NCO modulus.
		1		Select sideband from modulation result. 0b0 = upper sideband. 0b1 = lower sideband (spectral flip).
		0		Set this bit to 0. Integer NCO mode calculation: $DDSM\_FTW = (f_{CARRIER}/f_{DAC}) \times 2^{48}$ .
W	0x114	[7:0]		Write DDSM_FTW[7:0].

## START-UP SEQUENCE

Table 55. Main DAC Datapath Setup: PA Protect and Main NCOs

R/W	Register	Bits	Value	Description
W	0x115	[7:0]		Write DDSM_FTW[15:8].
W	0x116	[7:0]		Write DDSM_FTW[23:16].
W	0x117	[7:0]		Write DDSM_FTW[31:24].
W	0x118	[7:0]		Write DDSM_FTW[39:32].
W	0x119	[7:0]		Write DDSM_FTW[47:40].
W	0x11C	[7:0]		Write DDSM_NCO_PHASE_OFFSET[7:0]. Calculation: DDSM_NCO_PHASE_OFFSET = (degrees offset/180) × 2 <sup>15</sup> .
W	0x11D	[7:0]		Write DDSM_NCO_PHASE_OFFSET[15:8]. If using NCO modulus mode, also program modulus parameters. If not, skip this section. For modulus NCO mode: $(f_{\text{CARRIER}}/f_{\text{DAC}}) = (X + (A/B))/2^{48}$ , where DDSM_ACC_DELTA = A, DDSM_ACC_MODULUS = B, and DDSM_FTW = X.
W	0x124	[7:0]		Write DDSM_ACC_MODULUS[7:0].
W	0x125	[7:0]		Write DDSM_ACC_MODULUS[15:8].
W	0x126	[7:0]		Write DDSM_ACC_MODULUS[23:16].
W	0x127	[7:0]		Write DDSM_ACC_MODULUS[31:24].
W	0x128	[7:0]		Write DDSM_ACC_MODULUS[39:32].
W	0x129	[7:0]		Write DDSM_ACC_MODULUS[47:40].
W	0x12A	[7:0]		Write DDSM_ACC_DELTA[7:0].
W	0x12B	[7:0]		Write DDSM_ACC_DELTA[15:8].
W	0x12C	[7:0]		Write DDSM_ACC_DELTA[23:16].
W	0x12D	[7:0]		Write DDSM_ACC_DELTA[31:24].
W	0x12E	[7:0]		Write DDSM_ACC_DELTA[39:32].
W	0x12F	[7:0]		Write DDSM_ACC_DELTA[47:40].
W	0x113	0	0b1	Update all NCO phase and FTW words.

Table 56. JESD204B SERDES Required Interface Setup

R/W	Register	Bits	Value	Description
W	0x240	[7:0]	0xAA or 0xFF	EQ settings determined by amount of insertion loss according to Table 22. For insertion loss ≤ 11 dB, set to 0xAA; otherwise, set to 0xFF.
W	0x241	[7:0]	0xAA or 0xFF	EQ settings determined by amount of insertion loss according to Table 22. For insertion loss ≤ 11 dB, set to 0xAA; otherwise, set to 0xFF.
W	0x242	[7:0]	0x55 or 0xFF	EQ settings determined by amount of insertion loss according to Table 22. For insertion loss ≤ 11 dB, set to 0x55; otherwise, set to 0xFF.
W	0x243	[7:0]	0x55 or 0xFF	EQ settings determined by amount of insertion loss according to Table 22. For insertion loss ≤ 11 dB, set to 0x55; otherwise, set to 0xFF.
W	0x244	[7:0]	0x1F	EQ settings.
W	0x245	[7:0]	0x1F	EQ settings.
W	0x246	[7:0]	0x1F	EQ settings.
W	0x247	[7:0]	0x1F	EQ settings.
W	0x248	[7:0]	0x1F	EQ settings.
W	0x249	[7:0]	0x1F	EQ settings.
W	0x24A	[7:0]	0x1F	EQ settings.
W	0x24B	[7:0]	0x1F	EQ settings.
W	0x201	[7:0]		Power down unused PHYs. Bit x corresponds to SERDINx± pin power-down.
W	0x203			If in single-link mode, set to 0x01. If in dual-link mode and using both signals, set to 0x00.
		1	0b0	Power up driver by setting this bit to 0.
		0		Power up driver by setting this bit to 0 if using dual link and both signals.
W	0x253	[7:0]	0x01	Set to be LVDS output. For CMOS output on , set Bit 0 to 0.
W	0x254	[7:0]	0x01	Set to be LVDS output. For CMOS output on , set Bit 0 to 0.
W	0x210	[7:0]	0x16	SERDES required register write.



## START-UP SEQUENCE

Table 56. JESD204B SERDES Required Interface Setup

R/W	Register	Bits	Value	Description
W	0x216	[7:0]	0x05	SERDES required register write.
W	0x212	[7:0]	0xFF	SERDES required register write.
W	0x212	[7:0]	0x00	SERDES required register write.
W	0x210	[7:0]	0x87	SERDES required register write.
W	0x216	[7:0]	0x11	SERDES required register write.
W	0x213	[7:0]	0x01	SERDES required register write.
W	0x213	[7:0]	0x00	SERDES required register write.
W	0x200	[7:0]	0x00	Power up the SERDES circuitry blocks.
	Pause			Wait 100 ms.
W	0x210	[7:0]	0x86	SERDES required register write.
W	0x216	[7:0]	0x40	SERDES required register write.
W	0x213	[7:0]	0x01	SERDES required register write.
W	0x213	[7:0]	0x00	SERDES required register write.
W	0x210	[7:0]	0x86	SERDES required register write.
W	0x216	[7:0]	0x00	SERDES required register write.
W	0x213	[7:0]	0x01	SERDES required register write.
W	0x213	[7:0]	0x00	SERDES required register write.
W	0x210	[7:0]	0x87	SERDES required register write.
W	0x216	[7:0]	0x01	SERDES required register write.
W	0x213	[7:0]	0x01	SERDES required register write.
W	0x213	[7:0]	0x00	SERDES required register write.
W	0x280	[7:0]	0x05	SERDES required register write.
W	0x280	[7:0]	0x01	Start up SERDES PLL circuitry blocks and initiate SERDES PLL calibration.
R	0x281	0	0b1	Ensure Bit 0 of this register reads back 1 to indicate the SERDES PLL is locked.

Crossbar mapping writes the SERDIN<sub>x</sub> input pin that is the source for each given logical lane in these registers. A value of x corresponds to mapping data from the SERDIN<sub>x</sub> pin to the logical lane of the control bit field. These values in Table 57 vary with different PCB layout routing.

Table 57. Transport Layer Setup, Synchronization, and Enable Links

R/W	Register	Bits	Value	Description
W	0x308	[7:0]		Crossbar setup. Program the physical lane value that is providing data (the source) for each of the logical lanes. [5:3] = Logical Lane 1 source, [2:0] = Logical Lane 0 source.
W	0x309	[7:0]		[5:3] = Logical Lane 3 source, [2:0] = Logical Lane 2 source.
W	0x30A	[7:0]		[5:3] = Logical Lane 5 source, [2:0] = Logical Lane 4 source.
W	0x30B	[7:0]		[5:3] = Logical Lane 7 source, [2:0] = Logical Lane 6 source.
W	0x306	[7:0]	0x0C	If operating in Subclass 0, this register write is not needed.
W	0x307	[7:0]	0x0C	If operating in Subclass 0, this register write is not needed.
W	0x304	[7:0]		If operating in Subclass 0, this register write is not needed. For Subclass 1, these values must be determined by following one of the deterministic latency methods (with or without known delays), as mentioned in the <a href="#">Link Delay</a> section.
W	0x305	[7:0]		If operating in Subclass 0, this register write is not needed. For Subclass 1, these values must be determined by following one of the deterministic latency methods (with or without known delays), as mentioned in the <a href="#">Link Delay</a> section.
W	0x03B	[7:0]	0xF1	Enable the sync logic, and set the rotation mode to reset the synchronization logic upon a sync reset trigger.
W	0x03A	[7:0]	0x02	Set up sync for one-shot sync mode.
	SYSREF <sub>±</sub>			If operating in Subclass 1, send SYSREF <sub>±</sub> pulse edges to the device for synchronization alignment.
W	0x300	3	LINK_MODE	Corresponds to the mode selection made in Register 0x110. 0b0 = single-link mode.

## START-UP SEQUENCE

**Table 57. Transport Layer Setup, Synchronization, and Enable Links**

R/W	Register	Bits	Value	Description
				0b1 = dual-link mode.
		2	0b0	Select Link 0 for setup. This bit selects which link QBD is being paged. 0b0 = Link 0 (QBD0). 0b1 = Link 1 (QBD1).
		[1:0]	LINK_EN	Enables the links. 0b01 = single-link mode 0b11 = dual-link mode.

**Table 58. Cleanup Registers**

R/W	Register	Bits	Value	Description
W	0x1DE	[7:0]	0x00	Disable analog SPI. To debug and continue readback capability, write 0x03.
W	0x008	[7:0]	0xC0	Page all main DACs for TXEN control update.
W	0x596	[7:0]	0x0C	SPI turn on TXENx feature.

## REGISTER SUMMARY

Table 59. Register Summary

Reg	Name	Bit 7	Bit 6	Bit 5	Bit 4	Bit 3	Bit 2	Bit 1	Bit 0	Reset	RW
0x000	SPI_INTFCONFA	SOFTRESET_M	LSBFIRST_M	ADDRINC_M	SDOACTIVE_M	SDOACTIVE	ADDRINC	LSBFIRST	SOFT-RESET	0x00	R/W
0x001	SPI_INTFCONFB	SINGLEINS	CSSTALL	RESERVED						0x00	R/W
0x003	SPI_CHIPTYPE	CHIP_TYPE						0x04	R		
0x004	SPI_PRODIDL	PROD_ID[7:0]						0x72	R		
0x005	SPI_PRODIDH	PROD_ID[15:8]						0x91	R		
0x006	SPI_CHIPGRADE	PROD_GRADE				DEV_REVISION				0x02	R
0x008	SPI_PAGEINDX	MAINDAC_PAGE			CHANNEL_PAGE					0xFF	R/W
0x00A	SPI_SCRATCHPAD	SCRATCHPAD						0x00	R/W		
0x010	CHIP_ID_L	CHIP_ID[7:0]						0x00	R		
0x011	CHIP_ID_M1	CHIP_ID[15:8]						0x00	R		
0x012	CHIP_ID_M2	CHIP_ID[23:16]						0x00	R		
0x013	CHIP_ID_H	CHIP_ID[31:24]						0x00	R		
0x020	IRQ_ENABLE	RESERVED			EN_SYSREF_JITTER	EN_DATA_READY	EN_LANE_FIFO	EN_PRBSQ	EN_PRBSI	0x00	R/W
0x021	IRQ_ENABLE0	RESERVED				EN_DAC0_CAL_DONE	RESERVED		EN_PAERR0	0x00	R/W
0x022	IRQ_ENABLE1	RESERVED				EN_DAC1_CAL_DONE	RESERVED		EN_PAERR1	0x00	R/W
0x023	IRQ_ENABLE2	RESERVED		EN_DLL_LOST	EN_DLL_LOCK	RESERVED		EN_PLL_LOST	EN_PLL_LOCK	0x00	R/W
0x024	IRQ_STATUS	RESERVED			IRQ_SYSREF_JITTER	IRQ_DATA_READY	IRQ_LANE_FIFO	IRQ_PRBSQ	IRQ_PRBSI	0x00	R/W
0x025	IRQ_STATUS0	RESERVED				IRQ_DAC0_CAL_DONE	RESERVED		IRQ_PAERR0	0x00	R/W
0x026	IRQ_STATUS1	RESERVED				IRQ_DAC1_CAL_DONE	RESERVED		IRQ_PAERR1	0x00	R/W
0x027	IRQ_STATUS2	RESERVED		IRQ_DLL_LOST	IRQ_DLL_LOCK	RESERVED		IRQ_PLL_LOST	IRQ_PLL_LOCK	0x00	R/W
0x028	IRQ_OUTPUT_MUX	RESERVED			MUX_SYSREF_JITTER	MUX_DATA_READY	MUX_LANE_FIFO	MUX_PRBSQ	MUX_PRBSI	0x00	R/W
0x029	IRQ_OUTPUT_MUX0	RESERVED				MUX_DAC0_CAL_DONE	RESERVED		MUX_PAERR0	0x00	R/W
0x02A	IRQ_OUTPUT_MUX1	RESERVED				MUX_DAC1_CAL_DONE	RESERVED		MUX_PAERR1	0x00	R/W
0x02B	IRQ_OUTPUT_MUX2	RESERVED		MUX_DLL_LOST	MUX_DLL_LOCK	RESERVED		MUX_PLL_LOST	MUX_PLL_LOCK	0x00	R/W
0x02C	IRQ_STATUS_ALL	RESERVED						IRQ_STATUS_ALL	0x00	R/W	
0x036	SYSREF_	SYSREF_COUNT						0x00	R/W		

## REGISTER SUMMARY

Table 59. Register Summary

Reg	Name	Bit 7	Bit 6	Bit 5	Bit 4	Bit 3	Bit 2	Bit 1	Bit 0	Reset	RW	
	COUNT											
0x039	SYSREF_ERR_WINDOW	RESERVED	SYSREF_ERR_WINDOW								0x00	R/W
0x03A	SYSREF_MODE	RESERVED			SYNC_ROTATION_DONE	RESERVED		SYSREF_MODE_ONESHOT	RESERVED	0x10	R/W	
0x03B	ROTATION_MODE	SYNCLOGIC_EN	RESERVED	PERIODIC_RST_EN	NCORST_AFTER_ROT_EN	RESERVED		ROTATION_MODE		0xB0	R/W	
0x03F	TX_ENABLE	RESERVED		TXEN_DATA_PATH_DAC1	TXEN_DATAPATH_DAC0	RESERVED					0x00	R/W
0x050	CAL_CLK_DIV	RESERVED				CAL_CLK_DIV					0x28	R/W
0x051	CAL_CTRL	CAL_CTRL0	RESERVED				CAL_CTRL1		CAL_START		0x82	R/W
0x052	CAL_STAT	RESERVED					CAL_ACTIVE	CAL_FAIL_SEARCH	CAL_FINISH		0x00	R/W
0x059	FSC0	RESERVED						FSC_CTRL[1:0]			0xA0	R/W
0x05A	FSC1	FSC_CTRL[9:2]									0x28	R/W
0x061	CAL_DEBUG0	RESERVED	CAL_CTRL2	CAL_CTRL3	RESERVED	CAL_CTRL4	RESERVED				0x60	R/W
0x081	CLK_CTRL	RESERVED						CAL_CLK_PD1	CAL_CLK_PD0		0x00	R/W
0x083	NVM_CTRL0	NVM_CTRL0A	RESERVED					NVM_CTRL0B			0x02	R/W
0x084	SYSREF_CTRL	RESERVED	SYSREF_INPUTMODE	RESERVED					SYSREF_PD		0x00	R/W
0x085	NVM_CTRL1	RESERVED	NVM_CTRL1A			RESERVED		NVM_CTRL1B	NVM_CTRL1C		0x13	R/W
0x08D	ADC_CLK_CTRL0	RESERVED			CLKOUT_SWING						0x00	R/W
0x08F	ADC_CLK_CTRL2	RESERVED							PD_CLKOUT_DRIVER		0x00	R/W
0x090	DAC_POWERDOWN	RESERVED						DAC_PD1	DAC_PD0		0x03	R/W
0x091	ACLK_CTRL	RESERVED							ACLK_POWERDOWN		0x01	R/W
0x094	PLL_CLK_DIV	RESERVED						PLL_VCO_DIV3_EN	PLL_VCO_DIV2_EN		0x00	R/W
0x095	PLL_BYPASS	RESERVED							PLL_BYPASS		0x00	R/W
0x09A	NVM_CTRL	PD_BGR	RESERVED								0x00	R/W
0x0C0	DELAY_LINE_PD	RESERVED		DLL_CTRL0B	DLL_CTRL0A	RESERVED			DLL_PD		0x31	R/W
0x0C1	DLL_CTRL0	DLL_CTRL1C		DLL_CTRL1B	DLL_CTRL1A		RESERVED		DLL_ENABLE		0x70	R/W
0x0C3	DLL_STATUS	RESERVED							DLL_LOCK		0x00	R/W
0x0C7	DLL_READ	RESERVED							DLL_READ_EN		0x00	R/W

## REGISTER SUMMARY

Table 59. Register Summary

Reg	Name	Bit 7	Bit 6	Bit 5	Bit 4	Bit 3	Bit 2	Bit 1	Bit 0	Reset	RW
0x0CC	DLL_FINE_DELAY0	RESERVED		DLL_FINE_DELAY0						0x00	R/W
0x0CD	DLL_FINE_DELAY1	RESERVED		DLL_FINE_DELAY1						0x00	R/W
0x0DB	DLL_UPDATE	RESERVED							DLL_DELAY_UPDATE	0x00	R/W
0x100	DIG_RESET	RESERVED							DIG_DATAPATH_PD	0x01	R/W
0x110	JESD_MODE	MODE_NOT_IN_TABLE	COM_SYNC	JESD_MODE						0x20	R/W
0x111	INTRP_MODE	DP_INTERP_MODE				CH_INTERP_MODE				0x84	R/W
0x112	DDSM_DATAPATH_CFG	RESERVED		DDSM_MODE		DDSM_NCO_EN	DDSM_MODULUS_EN	DDSM_SEL_SIDE BAND	EN_SYNC_ALL_CHNL_NCO_RESETS	0x01	R/W
0x113	DDSM_FTW_UPDATE	RESERVED	DDSM_FTW_REQ_MODE			RESERVED	DDSM_FTW_LOAD_SYSREF	DDSM_FTW_LOAD_ACK	DDSM_FTW_LOAD_REQ	0x00	R/W
0x114	DDSM_FTW0	DDSM_FTW[7:0]								0x00	R/W
0x115	DDSM_FTW1	DDSM_FTW[15:8]								0x00	R/W
0x116	DDSM_FTW2	DDSM_FTW[23:16]								0x00	R/W
0x117	DDSM_FTW3	DDSM_FTW[31:24]								0x00	R/W
0x118	DDSM_FTW4	DDSM_FTW[39:32]								0x00	R/W
0x119	DDSM_FTW5	DDSM_FTW[47:40]								0x00	R/W
0x11C	DDSM_PHASE_OFFSET0	DDSM_NCO_PHASE_OFFSET[7:0]								0x00	R/W
0x11D	DDSM_PHASE_OFFSET1	DDSM_NCO_PHASE_OFFSET[15:8]								0x00	R/W
0x124	DDSM_ACC_MODULUS0	DDSM_ACC_MODULUS[7:0]								0x00	R/W
0x125	DDSM_ACC_MODULUS1	DDSM_ACC_MODULUS[15:8]								0x00	R/W
0x126	DDSM_ACC_MODULUS2	DDSM_ACC_MODULUS[23:16]								0x00	R/W
0x127	DDSM_ACC_MODULUS3	DDSM_ACC_MODULUS[31:24]								0x00	R/W
0x128	DDSM_ACC_MODULUS4	DDSM_ACC_MODULUS[39:32]								0x00	R/W
0x129	DDSM_ACC_MODULUS5	DDSM_ACC_MODULUS[47:40]								0x00	R/W
0x12A	DDSM_ACC_DELTA0	DDSM_ACC_DELTA[7:0]								0x00	R/W
0x12B	DDSM_ACC_DELTA1	DDSM_ACC_DELTA[15:8]								0x00	R/W
0x12C	DDSM_ACC_DELTA2	DDSM_ACC_DELTA[23:16]								0x00	R/W

## REGISTER SUMMARY

Table 59. Register Summary

Reg	Name	Bit 7	Bit 6	Bit 5	Bit 4	Bit 3	Bit 2	Bit 1	Bit 0	Reset	RW	
0x12D	DDSM_ACC_DELTA3				DDSM_ACC_DELTA[31:24]						0x00	R/W
0x12E	DDSM_ACC_DELTA4				DDSM_ACC_DELTA[39:32]						0x00	R/W
0x12F	DDSM_ACC_DELTA5				DDSM_ACC_DELTA[47:40]						0x00	R/W
0x130	DDSC_DATAPATH_CFG	RESERVED	DDSC_NCO_EN	RESERVED			DDSC_MODULUS_EN	DDSC_SEL_SIDE BAND	DDSC_EN_DC_INPUT	0x00	R/W	
0x131	DDSC_FTW_UPDATE	RESERVED					DDSC_FTW_LOAD_SYSREF	DDSC_FTW_LOAD_ACK	DDSC_FTW_LOAD_REQ	0x00	R/W	
0x132	DDSC_FTW0				DDSC_FTW[7:0]						0x00	R/W
0x133	DDSC_FTW1				DDSC_FTW[15:8]						0x00	R/W
0x134	DDSC_FTW2				DDSC_FTW[23:16]						0x00	R/W
0x135	DDSC_FTW3				DDSC_FTW[31:24]						0x00	R/W
0x136	DDSC_FTW4				DDSC_FTW[39:32]						0x00	R/W
0x137	DDSC_FTW5				DDSC_FTW[47:40]						0x00	R/W
0x138	DDSC_PHASE_OFFSET0				DDSC_NCO_PHASE_OFFSET[7:0]						0x00	R/W
0x139	DDSC_PHASE_OFFSET1				DDSC_NCO_PHASE_OFFSET[15:8]						0x00	R/W
0x13A	DDSC_ACC_MODULUS0				DDSC_ACC_MODULUS[7:0]						0x00	R/W
0x13B	DDSC_ACC_MODULUS1				DDSC_ACC_MODULUS[15:8]						0x00	R/W
0x13C	DDSC_ACC_MODULUS2				DDSC_ACC_MODULUS[23:16]						0x00	R/W
0x13D	DDSC_ACC_MODULUS3				DDSC_ACC_MODULUS[31:24]						0x00	R/W
0x13E	DDSC_ACC_MODULUS4				DDSC_ACC_MODULUS[39:32]						0x00	R/W
0x13F	DDSC_ACC_MODULUS5				DDSC_ACC_MODULUS[47:40]						0x00	R/W
0x140	DDSC_ACC_DELTA0				DDSC_ACC_DELTA[7:0]						0x00	R/W
0x141	DDSC_ACC_DELTA1				DDSC_ACC_DELTA[15:8]						0x00	R/W
0x142	DDSC_ACC_DELTA2				DDSC_ACC_DELTA[23:16]						0x00	R/W
0x143	DDSC_ACC_DELTA3				DDSC_ACC_DELTA[31:24]						0x00	R/W
0x144	DDSC_ACC_DELTA4				DDSC_ACC_DELTA[39:32]						0x00	R/W
0x145	DDSC_ACC_DELTA5				DDSC_ACC_DELTA[47:40]						0x00	R/W
0x146	CHNL_GAIN0				CHNL_GAIN[7:0]						0x00	R/W
0x147	CHNL_GAIN1	RESERVED						CHNL_GAIN[11:8]			0x08	R/W

## REGISTER SUMMARY

Table 59. Register Summary

Reg	Name	Bit 7	Bit 6	Bit 5	Bit 4	Bit 3	Bit 2	Bit 1	Bit 0	Reset	RW
0x148	DC_CAL_TONE0	DC_TEST_INPUT_AMPLITUDE[7:0]								0x00	R/W
0x149	DC_CAL_TONE1	DC_TEST_INPUT_AMPLITUDE[15:8]								0x00	R/W
0x14B	PRBS	PRBS_GOOD_Q	PRBS_GOOD_I	RESERVED	PRBS_INV_Q	PRBS_INV_I	PRBS_MODE	PRBS_RESET	PRBS_EN	0x10	R/W
0x14C	PRBS_ERROR_I	PRBS_COUNT_I								0x00	R
0x14D	PRBS_ERROR_Q	PRBS_COUNT_Q								0x00	R
0x14E	PRBS_CHANSEL	RESERVED					PRBS_CHANSEL			0x07	R/W
0x151	DECODE_MODE	RESERVED		MSB_MODE		RESERVED			0x00	R/W	
0x1DE	SPI_ENABLE	RESERVED						SPI_EN1	SPI_EN0	0x03	R/W
0x1E2	DDSM_CAL_FTW0	DDSM_CAL_FTW[7:0]								0x00	R/W
0x1E3	DDSM_CAL_FTW1	DDSM_CAL_FTW[15:8]								0x00	R/W
0x1E4	DDSM_CAL_FTW2	DDSM_CAL_FTW[23:16]								0x00	R/W
0x1E5	DDSM_CAL_FTW3	DDSM_CAL_FTW[31:24]								0x00	R/W
0x1E6	DDSM_CAL_MODE_DEF	RESERVED					DDSM_EN_CAL_ACC	DDSM_EN_CAL_DC_INPUT	DDSM_EN_CAL_FREQ_TUNE	0x00	R/W
0x1E7	DATAPATH_NCO_SYNC_CFG	RESERVED						ALL_NCO_SYNC_ACK	START_NCO_SYNC	0x00	R/W
0x200	MASTER_PD	RESERVED							SERDES_MASTER_PD	0x01	R/W
0x201	PHY_PD	PHY_PD								0xEE	R/W
0x203	GENERIC_PD	RESERVED						PD_SYNCOUT0	PD_SYNCOUT1	0x01	R/W
0x206	CDR_RESET	RESERVED							CDR_PHY_RESET	0x00	R/W
0x210	CBUS_ADDR	SERDES_CBUS_ADDR								0x00	R/W
0x212	CBUS_WRSTROBE_PHY	SERDES_CBUS_WRO								0x00	R/W
0x213	CBUS_WRSTROBE_OTHER	RESERVED							SERDES_CBUS_WR1	0x00	R/W
0x216	CBUS_WDATA	SERDES_CBUS_DATA								0x00	R/W
0x234	CDR_BITINVERSE	SEL_IF_PARDATAINV_DES_RC_CH								0x66	R/W
0x240	EQ_BOOST_PHY_3_0	EQ_BOOST_PHY3		EQ_BOOST_PHY2		EQ_BOOST_PHY1		EQ_BOOST_PHY0		0xFF	R/W

## REGISTER SUMMARY

Table 59. Register Summary

Reg	Name	Bit 7	Bit 6	Bit 5	Bit 4	Bit 3	Bit 2	Bit 1	Bit 0	Reset	RW
0x241	EQ_BOOST_PHY_7_4	EQ_BOOST_PHY7		EQ_BOOST_PHY6		EQ_BOOST_PHY5		EQ_BOOST_PHY4		0xFF	R/W
0x242	EQ_GAIN_PHY_3_0	EQ_GAIN_PHY3		EQ_GAIN_PHY2		EQ_GAIN_PHY1		EQ_GAIN_PHY0		0xFF	R/W
0x243	EQ_GAIN_PHY_7_4	EQ_GAIN_PHY7		EQ_GAIN_PHY6		EQ_GAIN_PHY5		EQ_GAIN_PHY4		0xFF	R/W
0x244	EQ_FB_PHY_0	RESERVED			EQ_PHY_0					0x19	R/W
0x245	EQ_FB_PHY_1	RESERVED			EQ_PHY1					0x19	R/W
0x246	EQ_FB_PHY_2	RESERVED			EQ_PHY2					0x19	R/W
0x247	EQ_FB_PHY_3	RESERVED			EQ_PHY3					0x19	R/W
0x248	EQ_FB_PHY_4	RESERVED			EQ_PHY4					0x19	R/W
0x249	EQ_FB_PHY_5	RESERVED			EQ_PHY5					0x19	R/W
0x24A	EQ_FB_PHY_6	RESERVED			EQ_PHY6					0x19	R/W
0x24B	EQ_FB_PHY_7	RESERVED			EQ_PHY7					0x19	R/W
0x250	LBT_REG_CNTRL_0	EN_LBT_DES_RC_CH								0x00	R/W
0x251	LBT_REG_CNTRL_1	RESERVED						EN_LBT_HALFRA TE_DES_RC	INIT_LBT_SYNC_DES _RC	0x02	R/W
0x253	SYNCOUT0_CTRL	RESERVED							SEL_SYNCOUT0 _MODE	0x00	R/W
0x254	SYNCOUT1_CTRL	RESERVED							SEL_SYNCOUT1 _MODE	0x00	R/W
0x280	PLL_ENABLE_CTRL	RESERVED					LOLSTICKY_CLEAR_ LCPLL_RC	LDSYNTH_LCPLL_RC	SERDES_PLL_STARTUP	0x01	R/W
0x281	PLL_STATUS	RESERVED							SERDES_PLL_LOCK	0x00	R
0x300	GENERAL_JRX_CTRL_0	RESERVED				LINK_MODE	LINK_PAGE	LINK_EN		0x00	R/W
0x302	DYN_LINK_LATENCY_0	RESERVED		DYN_LINK_LATENCY_0						0x00	R
0x303	DYN_LINK_LATENCY_1	RESERVED		DYN_LINK_LATENCY_1						0x00	R
0x304	LMFC_DELAY_0	RESERVED		LMFC_DELAY_0						0x00	R/W
0x305	LMFC_DELAY_1	RESERVED		LMFC_DELAY_1						0x00	R/W
0x306	LMFC_VAR_0	RESERVED		LMFC_VAR_0						0x3F	R/W
0x307	LMFC_VAR_1	RESERVED		LMFC_VAR_1						0x3F	R/W
0x308	XBAR_LN_0_1	RESERVED		LOGICAL_LANE1_SRC			LOGICAL_LANE0_SRC			0x08	R/W
0x309	XBAR_LN_2_3	RESERVED		LOGICAL_LANE3_SRC			LOGICAL_LANE2_SRC			0x1A	R/W
0x30A	XBAR_LN_4_5	RESERVED		LOGICAL_LANE5_SRC			LOGICAL_LANE4_SRC			0x2C	R/W
0x30B	XBAR_LN_6_7	RESERVED		LOGICAL_LANE7_SRC			LOGICAL_LANE6_SRC			0x3E	R/W
0x30C	FIFO_STATUS_REG_0	LANE_FIFO_FULL								0x00	R
0x30D	FIFO_STATUS	LANE_FIFO_EMPTY								0x00	R



## REGISTER SUMMARY

Table 59. Register Summary

Reg	Name	Bit 7	Bit 6	Bit 5	Bit 4	Bit 3	Bit 2	Bit 1	Bit 0	Reset	RW
	REG_1										
0x311	SYNCOUT_ GEN_0		RESERVED			EOMF_ MASK_1	EOMF_ MASK_0	EOF_ MASK_1	EOF_ MASK_0	0x00	R/W
0x312	SYNCOUT_ GEN_1		SYNC_ERR_DUR			RESERVED			0x00	R/W	
0x315	PHY_PRBS_ TEST_EN	PHY_TEST_EN								0x00	R/W
0x316	PHY_ PRBS_TEST_ CTRL	RESERVED	PHY_SRC_ERR_CNT			PHY_PRBS_PAT_SEL		PHY_TEST_ _START	PHY_TEST_ RESET	0x00	R/W
0x317	PHY_ PRBS_TEST_ THRESHOLD_ LOBITS	PHY_PRBS_THRESHOLD_LOBITS								0x00	R/W
0x318	PHY_ PRBS_TEST_ THRESHOLD_ MIDBITS	PHY_PRBS_THRESHOLD_MIDBITS								0x00	R/W
0x319	PHY_ PRBS_TEST_ THRESHOLD_ HIBITS	PHY_PRBS_THRESHOLD_HIBITS								0x00	R/W
0x31A	PHY_ PRBS_TEST_ ERRCNT_LOBI TS	PHY_PRBS_ERR_CNT_LOBITS								0x00	R
0x31B	PHY_PRBS_ TEST_ ERRCNT_ MIDBITS	PHY_PRBS_ERR_CNT_MIDBITS								0x00	R
0x31C	PHY_ PRBS_TEST_ ERRCNT_HIBIT S	PHY_PRBS_ERR_CNT_HIBITS								0x00	R
0x31D	PHY_ PRBS_TEST_ STATUS	PHY_PRBS_PASS								0xFF	R
0x31E	PHY_DATA_ SNAPSHOT_ CTRL	RESERVED						PHY_ GRAB_ MODE	PHY_GRAB_ _DATA	0x00	R/W
0x31F	PHY_ SNAPSHOT_ DATA_BYTE0	PHY_SNAPSHOT_DATA_BYTE0								0x00	R
0x320	PHY_ SNAPSHOT_ DATA_BYTE1	PHY_SNAPSHOT_DATA_BYTE1								0x00	R
0x321	PHY_ SNAPSHOT_ DATA_BYTE2	PHY_SNAPSHOT_DATA_BYTE2								0x00	R

## REGISTER SUMMARY

Table 59. Register Summary

Reg	Name	Bit 7	Bit 6	Bit 5	Bit 4	Bit 3	Bit 2	Bit 1	Bit 0	Reset	RW	
	DATA_BYTE2											
0x322	PHY_SNAPSHOT_DATA_BYTE3	PHY_SNAPSHOT_DATA_BYTE3									0x00	R
0x323	PHY_SNAPSHOT_DATA_BYTE4	PHY_SNAPSHOT_DATA_BYTE4									0x00	R
0x32C	SHORT_TPL_TEST_0	SHORT_TPL_SP_SEL				SHORT_TPL_M_SEL		SHORT_TPL_TEST_RESET	SHORT_TPL_TEST_EN		0x00	R/W
0x32D	SHORT_TPL_TEST_1	SHORT_TPL_REF_SP_LSB									0x00	R/W
0x32E	SHORT_TPL_TEST_2	SHORT_TPL_REF_SP_MSB									0x00	R/W
0x32F	SHORT_TPL_TEST_3	RESERVED	SHORT_TPL_IQ_SAMPLE_SEL	RESERVED					SHORT_TPL_FAIL		0x00	R/W
0x334	JESD_BIT_INVERSE_CTRL	JESD_BIT_INVERSE									0x00	R/W
0x400	DID_REG	DID_RD									0x00	R
0x401	BID_REG	BID_RD									0x00	R
0x402	LID0_REG	RESERVED	ADJDIR_RD	PHADJ_RD	LL_LID0					0x00	R	
0x403	SCR_L_REG	SCR_RD	RESERVED			L_RD-1				0x00	R	
0x404	F_REG	F_RD-1									0x00	R
0x405	K_REG	RESERVED				K_RD-1					0x00	R
0x406	M_REG	M_RD-1									0x00	R
0x407	CS_N_REG	CS_RD		RESERVED		N_RD-1					0x00	R
0x408	NP_REG	SUBCLASSV_RD				NP_RD-1					0x00	R
0x409	S_REG	JESDV_RD-1				S_RD-1					0x00	R
0x40A	HD_CF_REG	HD_RD	RESERVED			CF_RD					0x00	R
0x40B	RES1_REG	RES1_RD									0x00	R
0x40C	RES2_REG	RES2_RD									0x00	R
0x40D	CHECKSUM0_REG	LL_FCHK0									0x00	R
0x40E	COMPSUM0_REG	LL_FCMP0									0x00	R
0x412	LID1_REG	RESERVED				LL_LID1					0x00	R
0x415	CHECKSUM1_REG	LL_FCHK1									0x00	R
0x416	COMPSUM1_REG	LL_FCMP1									0x00	R
0x41A	LID2_REG	RESERVED				LL_LID2					0x00	R
0x41D	CHECKSUM2_REG	LL_FCHK2									0x00	R
0x41E	COMPSUM2_REG	LL_FCMP2									0x00	R

## REGISTER SUMMARY

Table 59. Register Summary

Reg	Name	Bit 7	Bit 6	Bit 5	Bit 4	Bit 3	Bit 2	Bit 1	Bit 0	Reset	RW
0x422	LID3_REG	RESERVED			LL_LID3				0x00	R	
0x425	CHECKSUM3_REG	LL_FCHK3								0x00	R
0x426	COMPSUM3_REG	LL_FCMP3								0x00	R
0x42A	LID4_REG	RESERVED			LL_LID4				0x00	R	
0x42D	CHECKSUM4_REG	LL_FCHK4								0x00	R
0x42E	COMPSUM4_REG	LL_FCMP4								0x00	R
0x432	LID5_REG	RESERVED			LL_LID5				0x00	R	
0x435	CHECKSUM5_REG	LL_FCHK5								0x00	R
0x436	COMPSUM5_REG	LL_FCMP5								0x00	R
0x43A	LID6_REG	RESERVED			LL_LID6				0x00	R	
0x43D	CHECKSUM6_REG	LL_FCHK6								0x00	R
0x43E	COMPSUM6_REG	LL_FCMP6								0x00	R
0x442	LID7_REG	RESERVED			LL_LID7				0x00	R	
0x445	CHECKSUM7_REG	LL_FCHK7								0x00	R
0x446	COMPSUM7_REG	LL_FCMP7								0x00	R
0x450	ILS_DID	DID								0x00	R/W
0x451	ILS_BID	BID								0x00	R/W
0x452	ILS_LID0	RESERVED	ADJDIR	PHADJ	LID0				0x00	R/W	
0x453	ILS_SCR_L	SCR	RESERVED			L-1				0x87	R/W
0x454	ILS_F	F-1								0x00	R/W
0x455	ILS_K	RESERVED			K-1				0x1F	R/W	
0x456	ILS_M	M-1								0x01	R/W
0x457	ILS_CS_N	CS		RESERVED		N-1				0x0F	R/W
0x458	ILS_NP	SUBCLASSV				NP-1				0x0F	R/W
0x459	ILS_S	JESDV				S-1				0x01	R/W
0x45A	ILS_HD_CF	HD	RESERVED			CF				0x80	R
0x45B	ILS_RES1	RES1								0x00	R/W
0x45C	ILS_RES2	RES2								0x00	R/W
0x45D	ILS_CHECKSUM	FCHK0								0x00	R/W
0x46C	LANE_DESKEW	ILD7	ILD6	ILD5	ILD4	ILD3	ILD2	ILD1	ILD0	0x00	R
0x46D	BAD_DISPARIY	BDE7	BDE6	BDE5	BDE4	BDE3	BDE2	BDE1	BDE0	0x00	R
0x46E	NOT_IN_TABLE	NIT7	NIT6	NIT5	NIT4	NIT3	NIT2	NIT1	NIT0	0x00	R
0x46F	UNEXPECTED_KCHAR	UEK7	UEK6	UEK5	UEK4	UEK3	UEK2	UEK1	UEK0	0x00	R
0x470	CODE_GRP_	CGS7	CGS6	CGS5	CGS4	CGS3	CGS2	CGS1	CGS0	0x00	R

## REGISTER SUMMARY

Table 59. Register Summary

Reg	Name	Bit 7	Bit 6	Bit 5	Bit 4	Bit 3	Bit 2	Bit 1	Bit 0	Reset	RW	
	SYNC											
0x471	FRAME_SYNC	FS7	FS6	FS5	FS4	FS3	FS2	FS1	FS0	0x00	R	
0x472	GOOD_CHECKSUM	CKS7	CKS6	CKS5	CKS4	CKS3	CKS2	CKS1	CKS0	0x00	R	
0x473	INIT_LANE_SYNC	ILS7	ILS6	ILS5	ILS4	ILS3	ILS2	ILS1	ILS0	0x00	R	
0x475	CTRLREG0	RESERVED				SOFTRST	FORCE-SYNCREQ	RESERVED	REPL_FRM_ENA	0x01	R/W	
0x476	CTRLREG1	RESERVED			QUAL_RDERR	RESERVED			FCHK_N	0x14	R/W	
0x477	CTRLREG2	ILS_MODE	RESERVED	REPDATA TEST	QUETESTERR	AR_ECNT	RESERVED			0x00	R/W	
0x478	KVAL	KSYNC								0x01	R/W	
0x47C	ERRORTHRES	ETH								0xFF	R/W	
0x47D	SYNC_ASSERT_MASK	RESERVED					SYNC_ASSERT_MASK				0x07	R/W
0x480	ECNT_CTRL0	RESERVED			ECNT_ENA0		ECNT_RST0			0x3F	R/W	
0x481	ECNT_CTRL1	RESERVED			ECNT_ENA1		ECNT_RST1			0x3F	R/W	
0x482	ECNT_CTRL2	RESERVED			ECNT_ENA2		ECNT_RST2			0x3F	R/W	
0x483	ECNT_CTRL3	RESERVED			ECNT_ENA3		ECNT_RST3			0x3F	R/W	
0x484	ECNT_CTRL4	RESERVED			ECNT_ENA4		ECNT_RST4			0x3F	R/W	
0x485	ECNT_CTRL5	RESERVED			ECNT_ENA5		ECNT_RST5			0x3F	R/W	
0x486	ECNT_CTRL6	RESERVED			ECNT_ENA6		ECNT_RST6			0x3F	R/W	
0x487	ECNT_CTRL7	RESERVED			ECNT_ENA7		ECNT_RST7			0x3F	R/W	
0x488	ECNT_TCH0	RESERVED				ECNT_TCH0			0x07	R/W		
0x489	ECNT_TCH1	RESERVED				ECNT_TCH1			0x07	R/W		
0x48A	ECNT_TCH2	RESERVED				ECNT_TCH2			0x07	R/W		
0x48B	ECNT_TCH3	RESERVED				ECNT_TCH3			0x07	R/W		
0x48C	ECNT_TCH4	RESERVED				ECNT_TCH4			0x07	R/W		
0x48D	ECNT_TCH5	RESERVED				ECNT_TCH5			0x07	R/W		
0x48E	ECNT_TCH6	RESERVED				ECNT_TCH6			0x07	R/W		
0x48F	ECNT_TCH7	RESERVED				ECNT_TCH7			0x07	R/W		
0x490	ECNT_STAT0	RESERVED				LANE_ENA0	ECNT_TCR0			0x00	R	
0x491	ECNT_STAT1	RESERVED				LANE_ENA1	ECNT_TCR1			0x00	R	
0x492	ECNT_STAT2	RESERVED				LANE_ENA2	ECNT_TCR2			0x00	R	
0x493	ECNT_STAT3	RESERVED				LANE_ENA3	ECNT_TCR3			0x00	R	
0x494	ECNT_STAT4	RESERVED				LANE_ENA4	ECNT_TCR4			0x00	R	
0x495	ECNT_STAT5	RESERVED				LANE_ENA5	ECNT_TCR5			0x00	R	
0x496	ECNT_STAT6	RESERVED				LANE_ENA6	ECNT_TCR6			0x00	R	
0x497	ECNT_STAT7	RESERVED				LANE_ENA7	ECNT_TCR7			0x00	R	
0x4B0	LINK_STATUS0	BDE0	NIT0	UEK0	ILD0	ILS0	CKS0	FS0	CGS0	0x00	R	
0x4B1	LINK_STATUS1	BDE1	NIT1	UEK1	ILD1	ILS1	CKS1	FS1	CGS1	0x00	R	
0x4B2	LINK_STATUS2	BDE2	NIT2	UEK2	ILD2	ILS2	CKS2	FS2	CGS2	0x00	R	
0x4B3	LINK_STATUS3	BDE3	NIT3	UEK3	ILD3	ILS3	CKS3	FS3	CGS3	0x00	R	
0x4B4	LINK_STATUS4	BDE4	NIT4	UEK4	ILD4	ILS4	CKS4	FS4	CGS4	0x00	R	
0x4B5	LINK_STATUS5	BDE5	NIT5	UEK5	ILD5	ILS5	CKS5	FS5	CGS5	0x00	R	
0x4B6	LINK_STATUS6	BDE6	NIT6	UEK6	ILD6	ILS6	CKS6	FS6	CGS6	0x00	R	
0x4B7	LINK_STATUS7	BDE7	NIT7	UEK7	ILD7	ILS7	CKS7	FS7	CGS7	0x00	R	
0x4B8	JESD_IRQ	EN_BDE	EN_NIT	EN_UEK	EN_ILD	EN_ILS	EN_CKS	EN_FS	EN_CGS	0x00	R/W	

## REGISTER SUMMARY

Table 59. Register Summary

Reg	Name	Bit 7	Bit 6	Bit 5	Bit 4	Bit 3	Bit 2	Bit 1	Bit 0	Reset	RW	
	ENABLEA											
0x4B9	JESD_IRQ_ENABLE	RESERVED							EN_ILAS	0x00	R/W	
0x4BA	JESD_IRQ_STATUSA	IRQ_BDE	IRQ_NIT	IRQ_UEK	IRQ_ILD	IRQ_ILS	IRQ_CKS	IRQ_FS	IRQ_CGS	0x00	R/W	
0x4BB	JESD_IRQ_STATUSB	RESERVED							IRQ_ILAS	0x00	R/W	
0x4BC	IRQ_OUTPUT_MUX_JESD	RESERVED							MUX_JESD_IRQ	0x00	R/W	
0x580	BE_SOFT_OFF_GAIN_CTRL	BE_SOFT_OFF_GAIN_EN	RESERVED				BE_GAIN_RAMP_RATE			0x00	R/W	
0x581	BE_SOFT_OFF_ENABLE	ENA_SHORT_PAERR_SOFTOFF	ENA_LONG_PAERR_SOFTOFF	RESERVED		ENA_JESD_ERR_SOFTOFF	ROTATE_SOFT_OFF_EN	TXEN_SOFT_OFF_EN	SPI_SOFT_OFF_EN	0xC6	R/W	
0x582	BE_SOFT_ON_ENABLE	SPI_SOFT_ON_EN	LONG_LEVEL_SOFTON_EN	RESERVED							0x40	R/W
0x583	LONG_PA_THRES_LSB	LONG_PA_THRESHOLD[7:0]								0x00	R/W	
0x584	LONG_PA_THRES_MSB	RESERVED			LONG_PA_THRESHOLD[12:8]					0x00	R/W	
0x585	LONG_PA_CONTROL	LONG_PA_ENABLE	RESERVED			LONG_PA_AVG_TIME				0x00	R/W	
0x586	LONG_PA_POWER_LSB	LONG_PA_POWER[7:0]								0x00	R	
0x587	LONG_PA_POWER_MSB	RESERVED			LONG_PA_POWER[12:8]					0x00	R	
0x588	SHORT_PA_THRES_LSB	SHORT_PA_THRESHOLD[7:0]								0x00	R/W	
0x589	SHORT_PA_THRES_MSB	RESERVED			SHORT_PA_THRESHOLD[12:8]					0x00	R/W	
0x58A	SHORT_PA_CONTROL	SHORT_PA_ENABLE	RESERVED					SHORT_PA_AVG_TIME		0x00	R/W	
0x58B	SHORT_PA_POWER_LSB	SHORT_PA_POWER[7:0]								0x00	R	
0x58C	SHORT_PA_POWER_MSB	RESERVED			SHORT_PA_POWER[12:8]					0x00	R	
0x58D	TXEN_SM_0	RESERVED							ENA_TXENSM	0x50	R/W	
0x596	BLANKING_CTRL	RESERVED				SPI_TXEN	ENA_SPI_TXEN	RESERVED		0x00	R/W	
0x597	JESD_PA_INT0	JESD_PA_INT_CNTRL[7:0]								0x00	R/W	
0x598	JESD_PA_INT1	RESERVED							JESD_PA_INT_CNTRL[8]	0x00	R/W	
0x599	TXEN_FLUSH	RESERVED							SPI	0x01	R/W	

## REGISTER SUMMARY

Table 59. Register Summary

Reg	Name	Bit 7	Bit 6	Bit 5	Bit 4	Bit 3	Bit 2	Bit 1	Bit 0	Reset	RW
	CTRL0								FLUSH_EN		
0x705	NVM_LOADER_EN	RESERVED							NVM_BLR_EN	0x00	R/W
0x790	DACPLL_PDCTRL0	PLL_PD5	PLL_PD4			PLL_PD3	PLL_PD2	PLL_PD1	PLL_PD0	0x02	R/W
0x791	DACPLL_PDCTRL1	RESERVED			PLL_PD10	PLL_PD9	PLL_PD8	PLL_PD7	PLL_PD6	0x00	R/W
0x792	DACPLL_CTRL0	RESERVED						D_CAL_RESET	D_RESET_VCO_DIV	0x02	R/W
0x793	DACPLL_CTRL1	RESERVED						M_DIVIDER-1		0x18	R/W
0x794	DACPLL_CTRL2	RESERVED		DACPLL_CP						0x04	R/W
0x795	DACPLL_CTRL3	RESERVED				D_CP_CALBITS				0x08	R/W
0x796	DACPLL_CTRL4	PLL_CTRL0				RESERVED				0xD2	R/W
0x797	DACPLL_CTRL5	RESERVED		PLL_CTRL1						0x20	R/W
0x798	DACPLL_CTRL6	RESERVED	PLL_CTRL3	PLL_CTRL2						0x1C	R/W
0x799	DACPLL_CTRL7	ADC_CLK_DIVIDER		N_DIVIDER						0x08	R/W
0x7A0	DACPLL_CTRL9	RESERVED		D_EN_VAR_FINE_PRE	RESERVED		D_EN_VAR_COARSE_PRE	RESERVED		0x90	R/W
0x7A2	DACPLL_CTRL10	RESERVED	D_REGULATOR_CAL_WAIT	D_VCO_CAL_WAIT		D_VCO_CAL_CYCLES		RESERVED	0x35	R/W	
0x7B5	PLL_STATUS	RESERVED							PLL_LOCK	0x00	R

## REGISTER DETAILS

Table 60. Register Details

Addr.	Name	Bits	Bit Name	Settings	Description	Reset	Access		
0x000	SPI_INTFCONFA	7	SOFTRESET_M		Soft reset (mirror). Set this bit to mirror Bit 0.	0x0	R		
		6	LSBFIRST_M		LSB first (mirror). Set this bit to mirror Bit 1.	0x0	R		
		5	ADDRINC_M		Address increment (mirror). Set this bit to mirror Bit 2.	0x0	R		
		4	SDOACTIVE_M		SDO active (mirror). Set this bit to mirror Bit 3.	0x0	R		
		3	SDOACTIVE		SDO active. Enables 4-wire SPI bus mode.	0x0	R/W		
		2	ADDRINC		Address increment. When set, this bit causes incrementing streaming addresses; otherwise, descending addresses are generated.	0x0	R/W		
				1	Streaming addresses are incremented.				
				0	Streaming addresses are decremented.				
0x001	SPI_INTFCONFB	7	SINGLEINS	1	Single instruction.	0x0	R/W		
				0	Perform single transfers.				
0x001	SPI_INTFCONFB	6	CSSTALL	0	CS stalling.	0x0	R/W		
				1	Disable CS stalling.				
				1	Enable CS stalling.				
		[5:0]	RESERVED		Reserved.	0x0	R/W		
0x003	SPI_CHIPTYPE	[7:0]	CHIP_TYPE		Chip type.	0x4	R		
0x004	SPI_PRODIDL	[7:0]	PROD_ID[7:0]		Product ID.	0x72	R		
0x005	SPI_PRODIDH	[7:0]	PROD_ID[15:8]		Product ID.	0x91	R		
0x006	SPI_CHIPGRADE	[7:4]	PROD_GRADE		Product grade.	0x0	R		
				[3:0]	DEV_REVISION				Device revision.
0x008	SPI_PAGEINDX	[7:6]	MAINDAC_PAGE		Sets the main DAC paging. Each high bit in this field pages a DAC starting at the LSB. Both main DACs can be paged and programmed at the same time if desired.	0x3	R/W		
				[5:0]	CHANNEL_PAGE				Sets channel paging. Each high bit in this field pages a complex channel starting at the LSB. Multiple channels can be paged and programmed at a time if desired.
0x00A	SPI_SCRATCHPAD	[7:0]	SCRATCHPAD		Scratch pad read/write register.	0x0	R/W		
0x010	CHIP_ID_L	[7:0]	CHIP_ID[7:0]		Chip ID serial number.	0x0	R		
0x011	CHIP_ID_M1	[7:0]	CHIP_ID[15:8]		Chip ID serial number.	0x0	R		
0x012	CHIP_ID_M2	[7:0]	CHIP_ID[23:16]		Chip ID serial number.	0x0	R		
0x013	CHIP_ID_H	[7:0]	CHIP_ID[31:24]		Chip ID serial number.	0x0	R		
0x020	IRQ_ENABLE	[7:5]	RESERVED		Reserved.	0x0	R		
				4	EN_SYSREF_JITTER				Enable SYSREF± jitter interrupt.
				3	EN_DATA_READY				Enable JESD204B receiver ready (JRX_DATA_READY) low interrupt.



## REGISTER DETAILS

Table 60. Register Details

Addr.	Name	Bits	Bit Name	Settings	Description	Reset	Access
0x021	IRQ_ENABLE0	2	EN_LANE_FIFO		Enable lane FIFO overflow/underflow interrupt.	0x0	R/W
		1	EN_PRBSQ		Enable PRBS imaginary error interrupt.	0x0	R/W
		0	EN_PRBSI		Enable PRBS real error interrupt.	0x0	R/W
		[7:4]	RESERVED		Reserved.	0x0	R
		3	EN_DAC0_CAL_DONE		Enable DAC0 calibration complete interrupt.	0x0	R/W
		[2:1]	RESERVED		Reserved.	0x0	R/W
0x022	IRQ_ENABLE1	0	EN_PAERR0		Enable PA protection error interrupt for DAC0.	0x0	R/W
		[7:4]	RESERVED		Reserved.	0x0	R
		3	EN_DAC1_CAL_DONE		Enable DAC1 calibration complete interrupt.	0x0	R/W
		[2:1]	RESERVED		Reserved.	0x0	R/W
0x023	IRQ_ENABLE2	0	EN_PAERR1		Enable PA protection error interrupt for DAC1.	0x0	R/W
		[7:6]	RESERVED		Reserved.	0x0	R
		5	EN_DLL_LOST		Enable DLL lock lost interrupt.	0x0	R/W
		4	EN_DLL_LOCK		Enable DLL lock interrupt.	0x0	R/W
		[3:2]	RESERVED		Reserved.	0x0	R/W
		1	EN_PLL_LOST		Enable PLL lock lost interrupt.	0x0	R/W
0x024	IRQ_STATUS	0	EN_PLL_LOCK		Enable PLL lock interrupt.	0x0	R/W
		[7:5]	RESERVED		Reserved.	0x0	R
		4	IRQ_SYSREF_JITTER		SYSREF± jitter too large. If EN_SYSREF_JITTER is low, IRQ_SYSREF_JITTER shows the current status. If EN_SYSREF_JITTER is high, IRQ_SYSREF_JITTER latches and pulls the IRQx pin low (x = the MUX_SYSREF_JITTER setting). Writing a 1 to IRQ_SYSREF_JITTER when latched clears the bit.	0x0	R/W
		3	IRQ_DATA_READY		JESD204x receiver data ready is low. If EN_DATA_READY is low, IRQ_DATA_READY shows the current status. If EN_DATA_READY is high, IRQ_DATA_READY latches and pulls the IRQx pin low (x = MUX_DATA_READY setting). Writing a 1 to IRQ_DATA_READY when latched clears the bit.	0x0	R/W
		2	IRQ_LANE_FIFO		Lane FIFO overflow/underflow. If EN_LANE_FIFO is low, IRQ_LANE_FIFO shows the current status. If EN_LANE_FIFO is high, IRQ_LANE_FIFO latches and pulls the IRQx pin low (x = MUX_LANE_FIFO setting). Writing a 1 to IRQ_LANE_FIFO when latched clears the bit.	0x0	R/W
		1	IRQ_PRBSQ		DAC1 PRBS error. If EN_PRBSQ is low, IRQ_PRBSQ shows the current status. If EN_PRBSQ is high, IRQ_PRBSQ latches and pulls the IRQx pin low (x = MUX_PRBSQ setting). Writing a 1 to IRQ_PRBSQ when latched clears the bit.	0x0	R/W
0x025	IRQ_STATUS0	0	IRQ_PRBSI		DAC0 PRBS error. If EN_PRBSI is low, IRQ_PRBSI shows the current status. If EN_PRBSI is high, IRQ_PRBSI latches and pulls the IRQx pin low (x = MUX_PRBSI setting). Writing a 1 to IRQ_PRBSI when latched clears the bit.	0x0	R/W
		[7:4]	RESERVED		Reserved.	0x0	R

## REGISTER DETAILS

Table 60. Register Details

Addr.	Name	Bits	Bit Name	Settings	Description	Reset	Access		
		3	IRQ_DAC0_CAL_DONE		DAC0 calibration done. If EN_DAC0_CAL_DONE is low, IRQ_DAC0_CAL_DONE shows the current status. If EN_DAC0_CAL_DONE is high, IRQ_DAC0_CAL_DONE latches and pulls the IRQx pin low (x = MUX_DAC0_CAL_DONE setting). Writing a 1 to IRQ_DAC0_CAL_DONE when latched clears the bit.	0x0	R/W		
		[2:1]	RESERVED		Reserved.	0x0	R/W		
		0	IRQ_PAERR0		DAC0 PA error. If EN_PAERR0 is low, IRQ_PAERR0 shows the current status. If EN_PAERR0 is high, IRQ_PAERR0 latches and pulls the IRQx pin low (x = MUX_PAERR0 setting). Writing a 1 to IRQ_PAERR0 when latched clears the bit.	0x0	R/W		
0x026	IRQ_STATUS1	[7:4]	RESERVED		Reserved.	0x0	R		
		3	IRQ_DAC1_CAL_DONE		DAC1 calibration done. If EN_DAC0_CAL_DONE is low, IRQ_DAC1_CAL_DONE shows the current status. If EN_DAC1_CAL_DONE is high, IRQ_DAC1_CAL_DONE latches and pulls the IRQx pin low (x = MUX_DAC1_CAL_DONE setting). Writing a 1 to IRQ_DAC1_CAL_DONE when latched clears the bit.	0x0	R/W		
		[2:1]	RESERVED		Reserved.	0x0	R/W		
		0	IRQ_PAERR1		DAC1 PA error. If EN_PAERR1 is low, IRQ_PAERR1 shows the current status. If EN_PAERR1 is high, IRQ_PAERR1 latches and pulls the IRQx pin low (x = MUX_PAERR1 setting). Writing a 1 to IRQ_PAERR1 when latched clears the bit.	0x0	R/W		
		0x027	IRQ_STATUS2	[7:6]	RESERVED		Reserved.	0x0	R
		5		IRQ_DLL_LOST		DLL lost. If EN_DLL_LOST is low, IRQ_DLL_LOST shows the current status. If EN_DLL_LOST is high, IRQ_DLL_LOST latches and pulls the IRQx pin low (x = MUX_DLL_LOST setting). Writing a 1 to IRQ_DLL_LOST when latched clears the bit.	0x0	R/W	
4	IRQ_DLL_LOCK			DLL locked. If EN_DLL_LOCK is low, IRQ_DLL_LOCK shows current status. If EN_DLL_LOCK is high, IRQ_DLL_LOCK latches and pulls the IRQx pin low (x = MUX_DLL_LOCK setting). Writing a 1 to IRQ_DLL_LOCK when latched clears the bit.	0x0	R/W			
[3:2]	RESERVED			Reserved.	0x0	R/W			
1	IRQ_PLL_LOST			DAC PLL lock lost. If EN_PLL_LOST is low, IRQ_PLL_LOST shows the current status. If EN_PLL_LOST is high, IRQ_PLL_LOST latches and pulls the IRQx pin low (x = MUX_PLL_LOST setting). Writing a 1 to IRQ_PLL_LOST when latched clears the bit.	0x0	R/W			
0	IRQ_PLL_LOCK			DAC PLL locked. If EN_PLL_LOCK is low, IRQ_PLL_LOCK shows the current status. If EN_PLL_LOCK is high, IRQ_PLL_LOCK latches and pulls the IRQx pin low (x = MUX_PLL_LOCK setting). Writing a 1 to IRQ_PLL_LOCK when latched clears the bit.	0x0	R/W			
0x028	IRQ_OUTPUT_MUX	[7:5]	RESERVED		Reserved.	0x0	R		

## REGISTER DETAILS

Table 60. Register Details

Addr.	Name	Bits	Bit Name	Settings	Description	Reset	Access
		4	MUX_SYSREF_JITTER	0 1	If EN_SYSREF_JITTER is set, this control chooses the $\overline{\text{IRQx}}$ output pin on which the event is triggered. Route IRQ trigger signal to the $\overline{\text{IRQ0}}$ pin. Route IRQ trigger signal to the $\overline{\text{IRQ1}}$ pin.	0x0	R/W
		3	MUX_DATA_READY	0 1	If EN_DATA_READY is set, this control chooses the $\overline{\text{IRQx}}$ output pin on which the event is triggered. Route IRQ trigger signal to the $\overline{\text{IRQ0}}$ pin. Route IRQ trigger signal to the $\overline{\text{IRQ1}}$ pin.	0x0	R/W
		2	MUX_LANE_FIFO	0 1	If EN_LANE_FIFO is set, this control chooses the $\overline{\text{IRQx}}$ output pin on which the event is triggered. Route IRQ trigger signal to the $\overline{\text{IRQ0}}$ pin. Route IRQ trigger signal to the $\overline{\text{IRQ1}}$ pin.	0x0	R/W
		1	MUX_PRBSQ	0 1	If EN_PRBSQ is set, this control chooses the $\overline{\text{IRQx}}$ output pin on which the event is triggered. Route IRQ trigger signal to the $\overline{\text{IRQ0}}$ pin. Route IRQ trigger signal to the $\overline{\text{IRQ1}}$ pin.	0x0	R/W
		0	MUX_PRBSI	0 1	If EN_PRBSI is set, this control chooses the $\overline{\text{IRQx}}$ output pin on which the event is triggered. Route IRQ trigger signal to the $\overline{\text{IRQ0}}$ pin. Route IRQ trigger signal to the $\overline{\text{IRQ1}}$ pin.	0x0	R/W
0x029	IRQ_OUTPUT_MUX0	[7:4]	RESERVED		Reserved.	0x0	R
		3	MUX_DAC0_CAL_DONE	0 1	If EN_DAC0_CAL_DONE is set, this control chooses the $\overline{\text{IRQx}}$ output pin on which the event is triggered. Route IRQ trigger signal to the $\overline{\text{IRQ0}}$ pin. Route IRQ trigger signal to the $\overline{\text{IRQ1}}$ pin.	0x0	R/W
		[2:1]	RESERVED		Reserved.	0x0	R/W
		0	MUX_PAERR0	0 1	If EN_PAERR0 is set, this control chooses the $\overline{\text{IRQx}}$ output pin on which the event is triggered. Route IRQ trigger signal to the $\overline{\text{IRQ0}}$ pin. Route IRQ trigger signal to the $\overline{\text{IRQ1}}$ pin.	0x0	R/W
0x02A	IRQ_OUTPUT_MUX1	[7:4]	RESERVED		Reserved.	0x0	R
		3	MUX_DAC1_CAL_DONE	0 1	If EN_DAC1_CAL_DONE is set, this control chooses the $\overline{\text{IRQx}}$ output pin on which the event is triggered. Route IRQ trigger signal to the $\overline{\text{IRQ0}}$ pin. Route IRQ trigger signal to the $\overline{\text{IRQ1}}$ pin.	0x0	R/W
		[2:1]	RESERVED		Reserved.	0x0	R/W
		0	MUX_PAERR1	0 1	If EN_PAERR1 is set, this control chooses the $\overline{\text{IRQx}}$ output pin on which the event is triggered. Route IRQ trigger signal to the $\overline{\text{IRQ0}}$ pin. Route IRQ trigger signal to the $\overline{\text{IRQ1}}$ pin.	0x0	R/W
0x02B	IRQ_OUTPUT_MUX2	[7:6]	RESERVED		Reserved.	0x0	R
		5	MUX_DLL_LOST	0 1	If EN_DLL_LOST is set, this control chooses the $\overline{\text{IRQx}}$ output pin on which the event is triggered. Route IRQ trigger signal to the $\overline{\text{IRQ0}}$ pin. Route IRQ trigger signal to the $\overline{\text{IRQ1}}$ pin.	0x0	R/W
		4	MUX_DLL_LOCK	0 1	If EN_DLL_LOCK is set, this control chooses the $\overline{\text{IRQx}}$ output pin on which the event is triggered. Route IRQ trigger signal to the $\overline{\text{IRQ0}}$ pin. Route IRQ trigger signal to the $\overline{\text{IRQ1}}$ pin.	0x0	R/W
		[3:2]	RESERVED		Reserved.	0x0	R/W

## REGISTER DETAILS

Table 60. Register Details

Addr.	Name	Bits	Bit Name	Settings	Description	Reset	Access
		1	MUX_PLL_LOST	0 1	If EN_PLL_LOST is set, this control chooses the $\overline{\text{IRQ}}$ pin on which the event is triggered. Route IRQ trigger signal to the $\overline{\text{IRQ0}}$ pin. Route IRQ trigger signal to the $\overline{\text{IRQ1}}$ pin.	0x0	R/W
		0	MUX_PLL_LOCK	0 1	If EN_PLL_LOCK is set, this control chooses the $\overline{\text{IRQ}}$ pin on which the event is triggered. Route IRQ trigger signal to the $\overline{\text{IRQ0}}$ pin. Route IRQ trigger signal to the $\overline{\text{IRQ1}}$ pin.	0x0	R/W
0x02C	IRQ_STATUS_ALL	[7:1]	RESERVED		Reserved.	0x0	R
		0	IRQ_STATUS_ALL		This bit is an OR of all the bits in Register 0x24 to Register 0x27. Writing a one to this bit clears any latched $\overline{\text{IRQ}}$ signals in Register 0x24 to Register 0x27.	0x0	R/W
0x036	SYSREF_COUNT	[7:0]	SYSREF_COUNT		Number of rising SYSREF $\pm$ edges to ignore before synchronization (pulse counting mode).	0x0	R/W
0x039	SYSREF_ERR_WINDOW	7	RESERVED		Reserved.	0x0	R
		[6:0]	SYSREF_ERR_WINDOW		Amount of jitter allowed on the SYSREF $\pm$ input. SYSREF $\pm$ jitter variations larger than this trigger an interrupt. Units are in DAC clocks.	0x0	R/W
0x03A	SYSREF_MODE	[7:5]	RESERVED		Reserved.	0x0	R
		4	SYNC_ROTATION_DONE		Synchronization logic rotation complete flag.	0x1	R
		[3:2]	RESERVED		Reserved.	0x0	R
		1	SYSREF_MODE_ONESHOT	00 01	Enable one-shot synchronization rotation mode. Monitor mode. Status/error flag for IRQ_SYSREF_JITTER is 1 if the SYSREF $\pm$ edge is outside the error window (Register 0x039, Bits[6:0]). Perform a single synchronization on the next SYSREF $\pm$ , then switch to monitor mode.	0x0	R/W
		0	RESERVED		Reserved.	0x0	R/W
0x03B	ROTATION_MODE	7	SYNCLOGIC_EN		This bit must always be set to 1 (default) for both Subclass 0 and Subclass 1 operations.	0x1	R/W
		6	RESERVED		Reserved. For proper operation, write this bit to a 1.	0x0	R/W
		5	PERIODIC_RST_EN		Synchronization required setting. Always set this bit to 1 for both Subclass 0 and Subclass 1 operation.	0x1	R/W
		4	NCORST_AFTER_ROT_EN		Set this bit to 1 to reset all NCOs after digital reset or synchronization rotation. Either this control or the START_NCO_SYNC bit (Register 0x1E7, Bit 0) can be used to reset all the NCOs (main and channel datapaths).	0x1	R/W
		[3:2]	RESERVED		Reserved.	0x0	R
		[1:0]	ROTATION_MODE	0	Selects the circuitry to be reset when a synchronization rotation occurs. Certain bits being set to 1 determine the actions taken when a synchronization rotation is performed. Bit 0 corresponds to a SERDES clock reset and realignment. Bit 1 corresponds to a datapath soft off/on gain, which must only be used if PA protection is in use. If PA protection is not used, set Bit 1 to 0. No action, with either the SERDES clocks or the datapath, occurs when a synchronization rotation occurs.	0x0	R/W

## REGISTER DETAILS

Table 60. Register Details

Addr.	Name	Bits	Bit Name	Settings	Description	Reset	Access
				1	The links drop and the SERDES clocks are reset. It is recommended to set this bit high so that when a synchronization rotation is performed, the SERDES clocks realign properly.		
				10	The datapath automatically uses the soft on/off functionality to turn on and off the datapath stream during a synchronization rotation to avoid corrupted data from being transmitted. Only use this feature if the PA protection block is in use.		
				11	Both the SERDES clock reset and datapath soft on/off feature are enabled.		
0x03F	TX_ENABLE	[7:6]	RESERVED		Reserved.	0x0	R/W
		5	TXEN_DATAPATH_DAC1	0 1	Selects whether the datapath of DAC1 is muted when the TXEN1 pin is brought low. Datapath output is normal. If TXEN1 = 0, the datapath output is immediately zeroed. If TXEN1 = 1, the datapath outputs normal operation.	0x0	R/W
		4	TXEN_DATAPATH_DAC0	0 1	Selects whether the datapath of DAC0 is muted when the TXEN0 pin is brought low. Datapath output is normal. If TXEN0 = 0, the datapath output is immediately zeroed. If TXEN0 = 1, the datapath outputs normal operation.	0x0	R/W
		[3:0]	RESERVED		Reserved.	0x0	R/W
0x050	CAL_CLK_DIV	[7:4]	RESERVED		Reserved	0x2	R/W
		[3:0]	CAL_CLK_DIV		Calibration register control. Set these bits to 0xA for optimized calibration setting.	0x8	R/W
0x051	CAL_CTRL	7	CAL_CTRL0	0 1	Calibration setting. Set this bit to 1. Reset the calibration engine. Enable the calibration routine.	0x1	R/W
		[6:3]	RESERVED		Reserved.	0x0	R/W
		[2:1]	CAL_CTRL1	1	Calibration mode selection. Set this bit field to 1 for optimized calibration mode. Paged by the MAINDAC_PAGE bits in Register 0x008. Set calibration control setting.	0x1	R/W
		0	CAL_START		Start calibration. After starting calibration, do not write to any register from Register 0x051 to Register 0x061 until Register 0x052, Bit 2 reads low (indicating that the calibration is no longer active). Paged by the MAINDAC_PAGE bits in Register 0x008.	0x0	R/W
0x052	CAL_STAT	[7:3]	RESERVED		Reserved.	0x0	R/W
		2	CAL_ACTIVE		Calibration active status flag. A readback of 1 indicates the calibration routine is still in progress. This control is paged by the MAINDAC_PAGE bits in Register 0x008.	0x0	R
		1	CAL_FAIL_SEARCH		Calibration failure flag. A readback of 1 indicates the calibration routine failed and is possibly not valid. This control is paged by the MAINDAC_PAGE bits in Register 0x008.	0x0	R
		0	CAL_FINISH		Calibration complete flag. A readback of 1 indicates the calibration completed. This control is paged by the MAINDAC_PAGE bits in Register 0x008.	0x0	R

## REGISTER DETAILS

Table 60. Register Details

Addr.	Name	Bits	Bit Name	Settings	Description	Reset	Access	
0x059	FSC0	[7:2]	RESERVED		Reserved.	0xA	R/W	
		[1:0]	FSC_CTRL[1:0]		Sets the full-scale current control. This control is paged by the MAINDAC_PAGE bits in Register 0x008. Full-scale current = 15.6 mA + FSC_CTRL × (25/256) (mA).	0x0	R/W	
0x05A	FSC1	[7:0]	FSC_CTRL[9:2]		Sets the full-scale current control. This control is paged by the MAINDAC_PAGE bits in Register 0x008. Full-scale current = 15.6 mA + FSC_CTRL × (25/256) (mA).	0x28	R/W	
0x061	CAL_DEBUG0	7	RESERVED		Reserved.	0x0	R/W	
		6	CAL_CTRL2		Calibration control. Set this bit to 1 for optimized calibration setting.	0x1	R/W	
		5	CAL_CTRL3		Calibration control. Set this bit to 1 for optimized calibration setting.	0x1	R/W	
		4	RESERVED		Reserved.	0x0	R/W	
		3	CAL_CTRL4		Calibration control. Set this bit to 1 for optimized calibration setting.	0x0	R/W	
		[2:0]	RESERVED		Reserved.	0x0	R/W	
0x081	CLK_CTRL	[7:2]	RESERVED		Reserved.	0x0	R/W	
		1	CAL_CLK_PD1		After the calibration is complete for DAC1 (Register 0x052, Bit 0 = 1), set this bit high to power down the calibration clock.	0x0	R/W	
		0	CAL_CLK_PD0		After the calibration is complete for DAC0 (Register 0x052, Bit 0 = 1), set this bit high to power down the calibration clock.	0x0	R/W	
0x083	NVM_CTRL0	7	NVM_CTRL0A		NVM register control for the ring oscillator.	0x0	R/W	
		[6:2]	RESERVED		Reserved.	0x0	R	
		[1:0]	NVM_CTRL0B	00	Divide by 8.	NVM register control for the ring oscillator.	0x2	R/W
				01	Divide by 16.			
		10	Divide by 32.					
		11	Divide by 64.					
0x084	SYSREF_CTRL	7	RESERVED		Reserved.	0x0	R/W	
		6	SYSREF_INPUTMODE	0	AC couple SYSREF±.	0x0	R/W	
				1	DC couple SYSREF±.			
		[5:1]	RESERVED		Reserved.	0x0	R/W	
0	SYSREF_PD		Power down the SYSREF± receiver and synchronization circuitry. If using Subclass 0, set this bit to 1 because the SYSREF± pins are not used.	0x0	R/W			
		0	SYSREF± receiver is powered on.					
		1	SYSREF± receiver is powered down.					
0x085	NVM_CTRL1	7	RESERVED		Reserved.	0x0	R	
		[6:4]	NVM_CTRL1A		NVM control.	0x1	R/W	
		[3:2]	RESERVED		Reserved.	0x0	R	
		1	NVM_CTRL1B		NVM control.	0x1	R/W	
		0	NVM_CTRL1C		NVM control.	0x1	R/W	
0x08D	ADC_CLK_CTRL0	[7:5]	RESERVED		Reserved.	0x0	R	
		[4:0]	CLKOUT_SWING		Controls the swing level of the ADC clock driver. Note that swing can be negative (inverts clock).	0x0	R/W	

## REGISTER DETAILS

Table 60. Register Details

Addr.	Name	Bits	Bit Name	Settings	Description	Reset	Access
					The calculation for Code 0 to Code 9 is as follows: ADC driver swing = 993 mV – CLKOUT_ SWING × 77 mV. The calculation for Code 10 to Code 19 is as follows: ADC driver swing = (20 – CLKOUT_SWING × 77 mV) – 1 V.		
0x08F	ADC_CLK_CTRL2	[7:1]	RESERVED		Reserved.	0x0	R
		0	PD_CLKOUT_ DRIVER		Powers down the CLKOUT± output driver.	0x0	R/W
0x090	DAC_POWERDOWN	[7:2]	RESERVED		Reserved.	0x0	R
		1	DAC_PD1	0	Powers down DAC1. Power up DAC1.	0x1	R/W
		0	DAC_PD0	1	Power down DAC1. Power up DAC0. Power down DAC0.	0x1	R/W
0x091	ACLK_CTRL	[7:1]	RESERVED		Reserved.	0x0	R/W
		0	ACLK_ POWERDOWN		Analog clock receiver power-down.	0x1	R/W
0x094	PLL_CLK_DIV	[7:2]	RESERVED		Reserved.	0x0	R
		1	PLL_VCO_DIV3_EN		Enable PLL output clock divide by 3.	0x0	R/W
		0	PLL_VCO_DIV2_EN	0	Enable PLL output clock divide by 2. DAC clock = PLL VCO clock frequency.	0x0	R/W
				1	DAC clock = PLL VCO clock frequency ÷ 2.		
0x095	PLL_BYPASS	[7:1]	RESERVED		Reserved.	0x0	R
		0	PLL_BYPASS	0	Enable direct clocking (bypassing the PLL clock). Use the internal PLL to generate the DAC clock.	0x0	R/W
				1	Bypass the PLL and directly clock with the DAC clock frequency.		
0x09A	NVM_CTRL	7	PD_BGR		Bias power-down. Set this bit to 1 to power down the internal bias.	0x0	R/W
		[6:0]	RESERVED		Reserved.	0x0	R/W
0x0C0	DELAY_LINE_PD	[7:6]	RESERVED		Reserved.	0x0	R
		5	DLL_CTRL0B		DLL control. Set this bit to 0 to power up the delay line during the device configuration sequence.	0x1	R/W
		4	DLL_CTRL0A		DLL control. Set this bit to 0 to power up the delay line during the device configuration sequence.	0x1	R/W
		[3:1]	RESERVED		Reserved.	0x0	R
		0	DLL_PD	0	Power down delay line. Set this bit to 0 to power up the delay line during the device configuration sequence.	0x1	R/W
				1	Power up and enable the delay line. Power down and bypass the delay line.		
0x0C1	DLL_CTRL0	[7:6]	DLL_CTRL1C		DAC control setting. Set this control to 1 for optimal performance.	0x1	R/W
		5	DLL_CTRL1B		DLL control search mode. If the DAC frequency is <4.5 GHz, set this bit to 0; otherwise, set this bit to 1.	0x1	R/W
		[4:3]	DLL_CTRL1A		DLL control search direction. Set this control to 1 for optimal performance.	0x2	R/W



## REGISTER DETAILS

Table 60. Register Details

Addr.	Name	Bits	Bit Name	Settings	Description	Reset	Access
		[2:1]	RESERVED		Reserved.	0x0	R
		0	DLL_ENABLE	0 1	DLL controller enable. Disable DLL. Enable DLL.	0x0	R/W
0x0C3	DLL_STATUS	[7:1]	RESERVED		Reserved.	0x0	R
		0	DLL_LOCK		DLL lock indicator. This control reads back 1 if the DLL locks.	0x0	R
0x0C7	DLL_READ	[7:1]	RESERVED		Reserved.	0x0	R
		0	DLL_READ_EN		Enable DLL readback status. A transition of 0 to 1 updates the lock status bit readback in Register 0x0C3.	0x0	R/W
0x0CC	DLL_FINE_DELAY0	[7:6]	RESERVED		Reserved.	0x0	R
		[5:0]	DLL_FINE_DELAY0		DLL delay control.	0x0	R/W
0x0CD	DLL_FINE_DELAY1	[7:6]	RESERVED		Reserved.	0x0	R
		[5:0]	DLL_FINE_DELAY1		DLL delay control.	0x0	R/W
0x0DB	DLL_UPDATE	[7:1]	RESERVED		Reserved.	0x0	R
		0	DLL_DELAY_UPDATE		DLL update control. A transition from 0 to 1 updates the DLL circuitry with the current register control settings.	0x0	R/W
0x100	DIG_RESET	[7:1]	RESERVED		Reserved.	0x0	R
		0	DIG_DATAPATH_PD	0 1	Holds all digital logic (SERDES digital, digital clock generation, and digital datapath) in reset until clock tree is stable. Normal operating mode. Holds the digital logic in reset. Must be released (set to 0) after clocks to the chip are stable (PLL and DLL blocks are locked) to use the digital datapath.	0x1	R/W
0x110	JESD_MODE	7	MODE_NOT_IN_TABLE		Programmed JESD204B mode and interpolation mode combination is not valid. Select a different combination.	0x0	R
		6	COM_SYNC		Combine the $\overline{\text{SYNCOUTx}}$ signals in dual link case.	0x0	R/W
		[5:0]	JESD_MODE		Sets the JESD204B mode configuration. See Table 13 for the JESD204B supported operating modes and compatible interpolation rates. Bit 5 of this control determines single link (set to 0) or dual link (set to 1). Bits[4:0] set the desired JESD204B mode according to Table 13.	0x20	R/W
0x111	INTRP_MODE	[7:4]	DP_INTERP_MODE	0x1 0x2 0x4 0x6 0x8 0xC	Sets main datapath interpolation rate. See Table 13 for the JESD204B supported operating modes and compatible JESD204B modes and channel interpolation rates. 1x. 2x. 4x. 6x. 8x. 12x.	0x8	R/W
		[3:0]	CH_INTERP_MODE		Sets channel interpolation rate. See Table 13 for the JESD204B supported operating modes and compatible JESD204B modes and main datapath interpolation rates.	0x4	R/W

## REGISTER DETAILS

Table 60. Register Details

Addr.	Name	Bits	Bit Name	Settings	Description	Reset	Access
				0x1 0x2 0x3 0x4 0x6 0x8	1×. 2×. 3×. 4×. 6×. 8×.		
0x112	DDSM_DATAPATH_CFG	[7:6]	RESERVED		Reserved.	0x0	R
		[5:4]	DDSM_MODE	00 01 10 11	Modulator switch mode selection. This control chooses the mode of operation for the main datapath NCO being configured. This control is paged by the MAINDAC_PAGE bits in Register 0x008. DAC0 = I0; DAC1 = I1. DAC0 = I0 + I1; DAC1 = Q0 + Q1. DAC0 = I0; DAC1 = Q0. DAC0 = I0 + I1; DAC1 = 0.	0x0	R/W
		3	DDSM_NCO_EN	0 1	Main datapath modulation enable. If the JESD204B mode chosen is a complex mode (main datapath interpolation >1×), this bit must be set to 1 for each main datapath being used. If no modulation is desired, set the FTW to be 0. This control is paged by the MAINDAC_PAGE bits in Register 0x008. Disable main datapath NCO. Enable main datapath NCO.	0x0	R/W
		2	DDSM_MODULUS_EN	0 1	Enable main datapath modulus DDS. This control is paged by the MAINDAC_PAGE bits in Register 0x008. Disable modulus DDS. Enable modulus DDS.	0x0	R/W
		1	DDSM_SEL_SIDE BAND	0 1	Selects upper or lower sideband from modulation result. This control is paged by the MAINDAC_PAGE bits in Register 0x008. Use upper sideband. Use lower sideband = spectral flip.	0x0	R/W
		0	EN_SYNC_ALL_CHNL_NCO_RESETS	0 1	Selects the signal channel NCOS used for resets and FTW updates. This control is paged by the MAINDAC_PAGE bits in Register 0x008. Channel NCOs reset or update their FTW based on channel NCO update requests. Channel NCOs reset or update their FTW based on main datapath NCO update requests.	0x1	R/W
0x113	DDSM_FTW_UPDATE	7	RESERVED		Reserved.	0x0	R
		[6:4]	DDSM_FTW_REQ_MODE	000 001 010 011	Frequency tuning word automatic update mode. This control is paged by the MAINDAC_PAGE bits in Register 0x008. No automatic requests are generated when the FTW registers are written. Automatically generates a DDSM_FTW_LOAD_REQ after DDSM_FTW Bits[7:0] are written. Automatically generates a DDSM_FTW_LOAD_REQ after DDSM_FTW Bits[15:8] are written. Automatically generates a DDSM_FTW_	0x0	R/W

## REGISTER DETAILS

Table 60. Register Details

Addr.	Name	Bits	Bit Name	Settings	Description	Reset	Access
				100	LOAD_REQ after DDSM_FTW Bits[23:16] are written. Automatically generates a DDSM_FTW_LOAD_REQ after DDSM_FTW Bits[31:24] are written.		
				101	Automatically generate a DDSM_FTW_LOAD_REQ after DDSM_FTW Bits[39:32] is written.		
				110	Automatically generates a DDSM_FTW_LOAD_REQ after DDSM_FTW Bits[47:40] are written.		
		3	RESERVED		Reserved.	0x0	R
		2	DDSM_FTW_LOAD_SYSREF		Uses the next rising edge of SYSREF± to trigger FTW load and reset. This bit also loads the calibration tone FTW, as well as the main NCO FTW on a rising edge detection. This control is paged by the MAINDAC_PAGE bits in Register 0x008.	0x0	R/W
		1	DDSM_FTW_LOAD_ACK	0 1	Frequency tuning word update acknowledge. This bit reads back 1 if the FTW and phase offset word is loaded properly. This control is paged by the MAINDAC_PAGE bits in Register 0x008. FTW is not loaded. FTW is loaded.	0x0	R
		0	DDSM_FTW_LOAD_REQ	0 1	Frequency tuning word update request from the SPI. This bit also loads the calibration tone FTW, as well as the main NCO FTW on a rising edge detection. This control is paged by the MAINDAC_PAGE bits in Register 0x008. Clear DDSM_FTW_LOAD_ACK. 0 to 1 transition loads the FTW.	0x0	R/W
0x114	DDSM_FTW0	[7:0]	DDSM_FTW[7:0]		Sets the main datapath NCO FTW. If DDSM_MODULUS_EN is low, the main datapath NCO frequency = $f_{DAC} \times (\text{DDSM\_FTW}/2^{48})$ . If DDSM_MODULUS_EN is high, the main datapath NCO frequency = $f_{DAC} \times (\text{DDSM\_FTW} + \text{DDSM\_ACC\_DELTA}/\text{DDSM\_ACC\_MODULUS})/2^{48}$ . DDSM_ACC_DELTA must be >0. DDSM_ACC_DELTA must be >DDSM_ACC_MODULUS. This control is paged by the MAINDAC_PAGE bits in Register 0x008.	0x0	R/W
0x115	DDSM_FTW1	[7:0]	DDSM_FTW[15:8]		Sets the main datapath NCO FTW. If DDSM_MODULUS_EN is low, the main datapath NCO frequency = $f_{DAC} \times (\text{DDSM\_FTW}/2^{48})$ . If DDSM_MODULUS_EN is high, the main datapath NCO frequency = $f_{DAC} \times (\text{DDSM\_FTW} + \text{DDSM\_ACC\_DELTA}/\text{DDSM\_ACC\_MODULUS})/2^{48}$ . DDSM_ACC_DELTA must be > 0. DDSM_ACC_DELTA must be > DDSM_ACC_MODULUS. This control is paged by the MAINDAC_PAGE bits in Register 0x008.	0x0	R/W
0x116	DDSM_FTW2	[7:0]	DDSM_FTW[23:16]		Sets the main datapath NCO FTW. If DDSM_MODULUS_EN is low, the main datapath NCO frequency = $f_{DAC} \times (\text{DDSM\_FTW}/2^{48})$ . If DDSM_MODULUS_EN is high, the main datapath NCO frequency = $f_{DAC} \times (\text{DDSM\_FTW} + \text{DDSM\_ACC\_DELTA}/\text{DDSM\_ACC\_MODULUS})/2^{48}$ . DDSM_ACC_DELTA must be > 0. DDSM_ACC_DELTA must be > DDSM_ACC_MODULUS. This control is paged by the MAINDAC_PAGE bits in Register 0x008.	0x0	R/W

## REGISTER DETAILS

Table 60. Register Details

Addr.	Name	Bits	Bit Name	Settings	Description	Reset	Access
0x117	DDSM_FTW3	[7:0]	DDSM_FTW[31:24]		ACC_MODULUS)/2 <sup>48</sup> . DDSM_ACC_DELTA must be > 0. DDSM_ACC_DELTA must be > DDSM_ACC_MODULUS. This control is paged by the MAINDAC_PAGE bits in Register 0x008.	0x0	R/W
0x118	DDSM_FTW4	[7:0]	DDSM_FTW[39:32]		Sets the main datapath NCO FTW. If DDSM_MODULUS_EN is low, the main datapath NCO frequency = f <sub>DAC</sub> × (DDSM_FTW/2 <sup>48</sup> ). If DDSM_MODULUS_EN is high, the main datapath NCO frequency = f <sub>DAC</sub> × (DDSM_FTW + DDSM_ACC_DELTA/DDSMAcc_MODULUS)/2 <sup>48</sup> . DDSM_ACC_DELTA must be > 0. DDSM_ACC_DELTA must be > DDSM_ACC_MODULUS. This control is paged by the MAINDAC_PAGE bits in Register 0x008.	0x0	R/W
0x119	DDSM_FTW5	[7:0]	DDSM_FTW[47:40]		Sets the main datapath NCO FTW. If DDSM_MODULUS_EN is low, the main datapath NCO frequency = f <sub>DAC</sub> × (DDSM_FTW/2 <sup>48</sup> ). If DDSM_MODULUS_EN is high, the main datapath NCO frequency = f <sub>DAC</sub> × (DDSM_FTW + DDSM_ACC_DELTA/DDSMAcc_MODULUS)/2 <sup>48</sup> . DDSM_ACC_DELTA must be > 0. DDSM_ACC_DELTA must be > DDSM_ACC_MODULUS. This control is paged by the MAINDAC_PAGE bits in Register 0x008.	0x0	R/W
0x11C	DDSM_PHASE_OFFSET0	[7:0]	DDSM_NCO_PHASE_OFFSET[7:0]		Sets main datapath NCO phase offset. Code is in 16-bit, twos complement format. Degrees offset = 180 × (code/2 <sup>15</sup> ). This control is paged by the MAINDAC_PAGE bits in Register 0x008.	0x0	R/W
0x11D	DDSM_PHASE_OFFSET1	[7:0]	DDSM_NCO_PHASE_OFFSET[15:8]		Sets main datapath NCO phase offset. Code is in 16-bit, twos complement format. Degrees offset = 180 × (code/2 <sup>15</sup> ). This control is paged by the MAINDAC_PAGE bits in Register 0x008.	0x0	R/W
0x124	DDSM_ACC_MODULUS0	[7:0]	DDSM_ACC_MODULUS[7:0]		Sets DDSM_ACC_MODULUS. If DDSM_MODULUS_EN is high, the main datapath NCO frequency = f <sub>DAC</sub> × (DDSM_FTW + DDSM_ACC_DELTA/DDSMAcc_MODULUS)/2 <sup>48</sup> . DDSM_ACC_DELTA must be > 0. DDSM_ACC_DELTA must be > DDSM_ACC_MODULUS. This control is paged by the MAINDAC_PAGE bits in Register 0x008.	0x0	R/W
0x125	DDSM_ACC_MODULUS1	[7:0]	DDSM_ACC_MODULUS[15:8]		Sets DDSM_ACC_MODULUS. If DDSM_MODULUS_EN is high, the main datapath NCO frequency = f <sub>DAC</sub> × (DDSM_FTW +	0x0	R/W

## REGISTER DETAILS

Table 60. Register Details

Addr.	Name	Bits	Bit Name	Settings	Description	Reset	Access
					DDSM_ACC_DELTA/DDSMM_ACC_MODULUS)/2 <sup>48</sup> . DDSM_ACC_DELTA must be > 0. DDSM_ACC_DELTA must be > DDSM_ACC_MODULUS. This control is paged by the MAINDAC_PAGE bits in Register 0x008.		
0x126	DDSM_ACC_MODULUS2	[7:0]	DDSM_ACC_MODULUS[23:16]		Sets DDSM_ACC_MODULUS. If DDSM_MODULUS_EN is high, the main datapath NCO frequency = $f_{DAC} \times (\text{DDSM\_FTW} + \text{DDSM\_ACC\_DELTA}/\text{DDSM\_ACC\_MODULUS})/2^{48}$ . DDSM_ACC_DELTA must be > 0. DDSM_ACC_DELTA must be > DDSM_ACC_MODULUS. This control is paged by the MAINDAC_PAGE bits in Register 0x008.	0x0	R/W
0x127	DDSM_ACC_MODULUS3	[7:0]	DDSM_ACC_MODULUS[31:24]		Sets DDSM_ACC_MODULUS. If DDSM_MODULUS_EN is high, the main datapath NCO frequency = $f_{DAC} \times (\text{DDSM\_FTW} + \text{DDSM\_ACC\_DELTA}/\text{DDSM\_ACC\_MODULUS})/2^{48}$ . DDSM_ACC_DELTA must be > 0. DDSM_ACC_DELTA must be > DDSM_ACC_MODULUS. This control is paged by the MAINDAC_PAGE bits in Register 0x008.	0x0	R/W
0x128	DDSM_ACC_MODULUS4	[7:0]	DDSM_ACC_MODULUS[39:32]		Sets DDSM_ACC_MODULUS. If DDSM_MODULUS_EN is high, the main datapath NCO frequency = $f_{DAC} \times (\text{DDSM\_FTW} + \text{DDSM\_ACC\_DELTA}/\text{DDSM\_ACC\_MODULUS})/2^{48}$ . DDSM_ACC_DELTA must be > 0. DDSM_ACC_DELTA must be > DDSM_ACC_MODULUS. This control is paged by the MAINDAC_PAGE bits in Register 0x008.	0x0	R/W
0x129	DDSM_ACC_MODULUS5	[7:0]	DDSM_ACC_MODULUS[47:40]		Sets DDSM_ACC_MODULUS. If DDSM_MODULUS_EN is high, the main datapath NCO frequency = $f_{DAC} \times (\text{DDSM\_FTW} + \text{DDSM\_ACC\_DELTA}/\text{DDSM\_ACC\_MODULUS})/2^{48}$ . DDSM_ACC_DELTA must be > 0. DDSM_ACC_DELTA must be > DDSM_ACC_MODULUS. This control is paged by the MAINDAC_PAGE bits in Register 0x008.	0x0	R/W
0x12A	DDSM_ACC_DELTA0	[7:0]	DDSM_ACC_DELTA[7:0]		Sets DDSM_ACC_DELTA. If DDSM_MODULUS_EN is high, main datapath NCO frequency = $f_{DAC} \times (\text{DDSM\_FTW} + \text{DDSM\_ACC\_DELTA}/\text{DDSM\_ACC\_MODULUS})/2^{48}$ . DDSM_ACC_DELTA must be > 0. DDSM_ACC_DELTA must be > DDSM_ACC_MODULUS. This control is paged by the MAINDAC_PAGE bits in Register 0x008.	0x0	R/W
0x12B	DDSM_ACC_DELTA1	[7:0]	DDSM_ACC_DELTA[15:8]		Sets DDSM_ACC_DELTA. If DDSM_MODULUS_EN is high, main datapath NCO frequency = $f_{DAC} \times (\text{DDSM\_FTW} + \text{DDSM\_ACC\_DELTA}/\text{DDSM\_ACC\_MODULUS})/2^{48}$ . DDSM_ACC_DELTA must be > 0. DDSM_ACC_DELTA must be > DDSM_ACC_MODULUS.	0x0	R/W

## REGISTER DETAILS

Table 60. Register Details

Addr.	Name	Bits	Bit Name	Settings	Description	Reset	Access
0x12C	DDSM_ACC_DELTA2	[7:0]	DDSM_ACC_DELTA[23:16]		MODULUS. This control is paged by the MAINDAC_PAGE bits in Register 0x008. Sets DDSM_ACC_DELTA. If DDSM_MODULUS_EN is high, main datapath NCO frequency = $f_{DAC} \times (\text{DDSM\_FTW} + \text{DDSM\_ACC\_DELTA}/\text{DDSM\_ACC\_MODULUS})/2^{48}$ . DDSM_ACC_DELTA must be > 0. DDSM_ACC_DELTA must be > DDSM_ACC_MODULUS. This control is paged by the MAINDAC_PAGE bits in Register 0x008.	0x0	R/W
0x12D	DDSM_ACC_DELTA3	[7:0]	DDSM_ACC_DELTA[31:24]		MODULUS. This control is paged by the MAINDAC_PAGE bits in Register 0x008. Sets DDSM_ACC_DELTA. If DDSM_MODULUS_EN is high, main datapath NCO frequency = $f_{DAC} \times (\text{DDSM\_FTW} + \text{DDSM\_ACC\_DELTA}/\text{DDSM\_ACC\_MODULUS})/2^{48}$ . DDSM_ACC_DELTA must be > 0. DDSM_ACC_DELTA must be > DDSM_ACC_MODULUS. This control is paged by the MAINDAC_PAGE bits in Register 0x008.	0x0	R/W
0x12E	DDSM_ACC_DELTA4	[7:0]	DDSM_ACC_DELTA[39:32]		MODULUS. This control is paged by the MAINDAC_PAGE bits in Register 0x008. Sets DDSM_ACC_DELTA. If DDSM_MODULUS_EN is high, main datapath NCO frequency = $f_{DAC} \times (\text{DDSM\_FTW} + \text{DDSM\_ACC\_DELTA}/\text{DDSM\_ACC\_MODULUS})/2^{48}$ . DDSM_ACC_DELTA must be > 0. DDSM_ACC_DELTA must be > DDSM_ACC_MODULUS. This control is paged by the MAINDAC_PAGE bits in Register 0x008.	0x0	R/W
0x12F	DDSM_ACC_DELTA5	[7:0]	DDSM_ACC_DELTA[47:40]		MODULUS. This control is paged by the MAINDAC_PAGE bits in Register 0x008. Sets DDSM_ACC_DELTA. If DDSM_MODULUS_EN is high, main datapath NCO frequency = $f_{DAC} \times (\text{DDSM\_FTW} + \text{DDSM\_ACC\_DELTA}/\text{DDSM\_ACC\_MODULUS})/2^{48}$ . DDSM_ACC_DELTA must be > 0. DDSM_ACC_DELTA must be > DDSM_ACC_MODULUS. This control is paged by the MAINDAC_PAGE bits in Register 0x008.	0x0	R/W
0x130	DDSC_DATAPATH_CFG	7	RESERVED		Reserved.	0x0	R
		6	DDSC_NCO_EN	0 1	Channel datapath modulation enable. If the JESD204B mode chosen is a complex mode (channel interpolation >1x), this bit must be set to 1 for each channel datapath being used. If no modulation is desired, set the FTW to 0. This control is paged by the CHANNEL_PAGE bits in Register 0x008. Disable channel NCO. Enable channel NCO.	0x0	R/W
		[5:3]	RESERVED		Reserved.	0x0	R/W
		2	DDSC_MODULUS_EN	0 1	Enable channel modulus DDS. This control is paged by the CHANNEL_PAGE bits in Register 0x008. Disable modulus DDS. Enable modulus DDS.	0x0	R/W
		1	DDSC_SEL_SIDE BAND	0	Selects upper or lower sideband from modulation result. This control is paged by the CHANNEL_PAGE bits in Register 0x008. Use upper sideband.	0x0	R/W

## REGISTER DETAILS

Table 60. Register Details

Addr.	Name	Bits	Bit Name	Settings	Description	Reset	Access
				1	Use lower sideband = spectral flip.		
		0	DDSC_EN_DC_INPUT	0 1	Enable test tone generation by sending dc to input level to channel DDS. Set the amplitude in the DC_TEST_INPUT_AMPLITUDE control (Register 0x148 and Register 0x149). This control is paged by the CHANNEL_PAGE bits in Register 0x008. Disable test tone generation. Enable test tone generation.	0x0	R/W
0x131	DDSC_FTW_UPDATE	[7:3]	RESERVED		Reserved.	0x0	R
		2	DDSC_FTW_LOAD_SYSREF		Use next rising edge of SYSREF± to trigger FTW load and reset. This control is paged by the CHANNEL_PAGE bits in Register 0x008.	0x0	R/W
		1	DDSC_FTW_LOAD_ACK	0 1	Frequency tuning word update acknowledge bit. This bit reads back 1 if the FTW and phase offset word is loaded properly. This control is paged by the CHANNEL_PAGE bits in Register 0x008. FTW is not loaded. FTW is loaded.	0x0	R
		0	DDSC_FTW_LOAD_REQ	0 1	Frequency tuning word update request from the SPI. This control is paged by the CHANNEL_PAGE bits in Register 0x008. No FTW update. 0 to 1 transition loads the FTW.	0x0	R/W
0x132	DDSC_FTW0	[7:0]	DDSC_FTW[7:0]		Sets the channel datapath NCO FTW. If DDSC_MODULUS_EN is low, the main datapath NCO frequency = $f_{DAC} \times (DDSC\_FTW/2^{48})$ . If DDSC_MODULUS_EN is high, main datapath NCO frequency = $f_{DAC} \times (DDSC\_FTW + DDSC\_ACC\_DELTA/DDSC\_ACC\_MODULUS)/2^{48}$ . DDSC_ACC_DELTA must be > 0. DDSC_ACC_DELTA must be > DDSC_ACC_MODULUS. This control is paged by the CHANNEL_PAGE bits in Register 0x008.	0x0	R/W
0x133	DDSC_FTW1	[7:0]	DDSC_FTW[15:8]		Sets the channel datapath NCO FTW. If DDSC_MODULUS_EN is low, the main datapath NCO frequency = $f_{DAC} \times (DDSC\_FTW/2^{48})$ . If DDSC_MODULUS_EN is high, main datapath NCO frequency = $f_{DAC} \times (DDSC\_FTW + DDSC\_ACC\_DELTA/DDSC\_ACC\_MODULUS)/2^{48}$ . DDSC_ACC_DELTA must be > 0. DDSC_ACC_DELTA must be > DDSC_ACC_MODULUS. This control is paged by the CHANNEL_PAGE bits in Register 0x008.	0x0	R/W
0x134	DDSC_FTW2	[7:0]	DDSC_FTW[23:16]		Sets the channel datapath NCO FTW. If DDSC_MODULUS_EN is low, the main datapath NCO frequency = $f_{DAC} \times (DDSC\_FTW/2^{48})$ . If DDSC_MODULUS_EN is high, main datapath NCO frequency = $f_{DAC} \times (DDSC\_FTW + DDSC\_ACC\_DELTA/DDSC\_ACC\_MODULUS)/2^{48}$ . DDSC_ACC_DELTA must be > 0. DDSC_ACC_DELTA must be > DDSC_ACC_MODULUS. This control is paged by the CHANNEL_PAGE bits in Register 0x008.	0x0	R/W



## REGISTER DETAILS

Table 60. Register Details

Addr.	Name	Bits	Bit Name	Settings	Description	Reset	Access
0x135	DDSC_FTW3	[7:0]	DDSC_FTW[31:24]		Sets the channel datapath NCO FTW. If DDSC_MODULUS_EN is low, the main datapath NCO frequency = $f_{DAC} \times (DDSC\_FTW/2^{48})$ . If DDSC_MODULUS_EN is high, main datapath NCO frequency = $f_{DAC} \times (DDSC\_FTW + DDSC\_ACC\_DELTA/DDSC\_ACC\_MODULUS)/2^{48}$ . DDSC_ACC_DELTA must be > 0. DDSC_ACC_DELTA must be > DDSC_ACC_MODULUS. This control is paged by the CHANNEL_PAGE bits in Register 0x008.	0x0	R/W
0x136	DDSC_FTW4	[7:0]	DDSC_FTW[39:32]		Sets the channel datapath NCO FTW. If DDSC_MODULUS_EN is low, the main datapath NCO frequency = $f_{DAC} \times (DDSC\_FTW/2^{48})$ . If DDSC_MODULUS_EN is high, main datapath NCO frequency = $f_{DAC} \times (DDSC\_FTW + DDSC\_ACC\_DELTA/DDSC\_ACC\_MODULUS)/2^{48}$ . DDSC_ACC_DELTA must be > 0. DDSC_ACC_DELTA must be > DDSC_ACC_MODULUS. This control is paged by the CHANNEL_PAGE bits in Register 0x008.	0x0	R/W
0x137	DDSC_FTW5	[7:0]	DDSC_FTW[47:40]		Sets the channel datapath NCO FTW. If DDSC_MODULUS_EN is low, the main datapath NCO frequency = $f_{DAC} \times (DDSC\_FTW/2^{48})$ . If DDSC_MODULUS_EN is high, main datapath NCO frequency = $f_{DAC} \times (DDSC\_FTW + DDSC\_ACC\_DELTA/DDSC\_ACC\_MODULUS)/2^{48}$ . DDSC_ACC_DELTA must be > 0. DDSC_ACC_DELTA must be > DDSC_ACC_MODULUS. This control is paged by the CHANNEL_PAGE bits in Register 0x008.	0x0	R/W
0x138	DDSC_PHASE_OFFSET0	[7:0]	DDSC_NCO_PHASE_OFFSET[7:0]		Sets the channel NCO phase offset. Code is in 16-bit, twos complement format. Degrees offset = $180 \times (\text{code}/2^{15})$ . This control is paged by the CHANNEL_PAGE bits in Register 0x008.	0x0	R/W
0x139	DDSC_PHASE_OFFSET1	[7:0]	DDSC_NCO_PHASE_OFFSET[15:8]		Sets the channel NCO phase offset. Code is in 16-bit, twos complement format. Degrees offset = $180 \times (\text{code}/2^{15})$ . This control is paged by the CHANNEL_PAGE bits in Register 0x008.	0x0	R/W
0x13A	DDSC_ACC_MODULUS0	[7:0]	DDSC_ACC_MODULUS[7:0]		Sets DDSC_ACC_MODULUS. If DDSC_MODULUS_EN is high, the main datapath NCO frequency = $f_{DAC} \times (DDSC\_FTW + DDSC\_ACC\_DELTA/DDSC\_ACC\_MODULUS)/2^{48}$ . DDSC_ACC_DELTA must be > 0. DDSC_ACC_DELTA must be > DDSC_ACC_MODULUS. This control is paged by the CHANNEL_PAGE bits in Register 0x008.	0x0	R/W
0x13B	DDSC_ACC_MODULUS1	[7:0]	DDSC_ACC_MODULUS[15:8]		Sets DDSC_ACC_MODULUS. If DDSC_MODULUS_EN is high, the main datapath NCO frequency = $f_{DAC} \times (DDSC\_FTW + DDSC\_ACC\_DELTA/DDSC\_ACC\_MODULUS)/2^{48}$ . DDSC_ACC_DELTA must be > 0. DDSC_ACC_DELTA must be > DDSC_ACC_MODULUS. This control is paged by the CHANNEL_PAGE bits in Register 0x008.	0x0	R/W

## REGISTER DETAILS

Table 60. Register Details

Addr.	Name	Bits	Bit Name	Settings	Description	Reset	Access
0x13C	DDSC_ACC_MODULUS2	[7:0]	DDSC_ACC_MODULUS[23:16]		PAGE bits in Register 0x008. Sets DDSC_ACC_MODULUS. If DDSC_MODULUS_EN is high, the main datapath NCO frequency = $f_{DAC} \times (DDSC\_FTW + DDSC\_ACC\_DELTA/DDSC\_ACC\_MODULUS)/2^{48}$ . DDSC_ACC_DELTA must be > 0. DDSC_ACC_DELTA must be > DDSC_ACC_MODULUS. This control is paged by the CHANNEL_PAGE bits in Register 0x008.	0x0	R/W
0x13D	DDSC_ACC_MODULUS3	[7:0]	DDSC_ACC_MODULUS[31:24]		Sets DDSC_ACC_MODULUS. If DDSC_MODULUS_EN is high, the main datapath NCO frequency = $f_{DAC} \times (DDSC\_FTW + DDSC\_ACC\_DELTA/DDSC\_ACC\_MODULUS)/2^{48}$ . DDSC_ACC_DELTA must be > 0. DDSC_ACC_DELTA must be > DDSC_ACC_MODULUS. This control is paged by the CHANNEL_PAGE bits in Register 0x008.	0x0	R/W
0x13E	DDSC_ACC_MODULUS4	[7:0]	DDSC_ACC_MODULUS[39:32]		Sets DDSC_ACC_MODULUS. If DDSC_MODULUS_EN is high, the main datapath NCO frequency = $f_{DAC} \times (DDSC\_FTW + DDSC\_ACC\_DELTA/DDSC\_ACC\_MODULUS)/2^{48}$ . DDSC_ACC_DELTA must be > 0. DDSC_ACC_DELTA must be > DDSC_ACC_MODULUS. This control is paged by the CHANNEL_PAGE bits in Register 0x008.	0x0	R/W
0x13F	DDSC_ACC_MODULUS5	[7:0]	DDSC_ACC_MODULUS[47:40]		Sets DDSC_ACC_MODULUS. If DDSC_MODULUS_EN is high, the main datapath NCO frequency = $f_{DAC} \times (DDSC\_FTW + DDSC\_ACC\_DELTA/DDSC\_ACC\_MODULUS)/2^{48}$ . DDSC_ACC_DELTA must be > 0. DDSC_ACC_DELTA must be > DDSC_ACC_MODULUS. This control is paged by the CHANNEL_PAGE bits in Register 0x008.	0x0	R/W
0x140	DDSC_ACC_DELTA0	[7:0]	DDSC_ACC_DELTA[7:0]		Sets DDSC_ACC_DELTA. If DDSC_MODULUS_EN is high, the main datapath NCO frequency = $f_{DAC} \times (DDSC\_FTW + DDSC\_ACC\_DELTA/DDSC\_ACC\_MODULUS)/2^{48}$ . DDSC_ACC_DELTA must be > 0. DDSC_ACC_DELTA must be > DDSC_ACC_MODULUS. This control is paged by the CHANNEL_PAGE bits in Register 0x008.	0x0	R/W
0x141	DDSC_ACC_DELTA1	[7:0]	DDSC_ACC_DELTA[15:8]		Sets DDSC_ACC_DELTA. If DDSC_MODULUS_EN is high, the main datapath NCO frequency = $f_{DAC} \times (DDSC\_FTW + DDSC\_ACC\_DELTA/DDSC\_ACC\_MODULUS)/2^{48}$ . DDSC_ACC_DELTA must be > 0. DDSC_ACC_DELTA must be > DDSC_ACC_MODULUS. This control is paged by the CHANNEL_PAGE bits in Register 0x008.	0x0	R/W
0x142	DDSC_ACC_DELTA2	[7:0]	DDSC_ACC_		Sets DDSC_ACC_DELTA. If DDSC_	0x0	R/W

## REGISTER DETAILS

Table 60. Register Details

Addr.	Name	Bits	Bit Name	Settings	Description	Reset	Access
			DELTA[23:16]		MODULUS_EN is high, the main datapath NCO frequency = $f_{DAC} \times (DDSC\_FTW + DDSC\_ACC\_DELTA/DDSC\_ACC\_MODULUS)/2^{48}$ . DDSC_ACC_DELTA must be > 0. DDSC_ACC_DELTA must be > DDSC_ACC_MODULUS. This control is paged by the CHANNEL_PAGE bits in Register 0x008.		
0x143	DDSC_ACC_DELTA3	[7:0]	DDSC_ACC_DELTA[31:24]		Sets DDSC_ACC_DELTA. If DDSC_MODULUS_EN is high, the main datapath NCO frequency = $f_{DAC} \times (DDSC\_FTW + DDSC\_ACC\_DELTA/DDSC\_ACC\_MODULUS)/2^{48}$ . DDSC_ACC_DELTA must be > 0. DDSC_ACC_DELTA must be > DDSC_ACC_MODULUS. This control is paged by the CHANNEL_PAGE bits in Register 0x008.	0x0	R/W
0x144	DDSC_ACC_DELTA4	[7:0]	DDSC_ACC_DELTA[39:32]		Sets DDSC_ACC_DELTA. If DDSC_MODULUS_EN is high, the main datapath NCO frequency = $f_{DAC} \times (DDSC\_FTW + DDSC\_ACC\_DELTA/DDSC\_ACC\_MODULUS)/2^{48}$ . DDSC_ACC_DELTA must be > 0. DDSC_ACC_DELTA must be > DDSC_ACC_MODULUS. This control is paged by the CHANNEL_PAGE bits in Register 0x008.	0x0	R/W
0x145	DDSC_ACC_DELTA5	[7:0]	DDSC_ACC_DELTA[47:40]		Sets DDSC_ACC_DELTA. If DDSC_MODULUS_EN is high, the main datapath NCO frequency = $f_{DAC} \times (DDSC\_FTW + DDSC\_ACC\_DELTA/DDSC\_ACC\_MODULUS)/2^{48}$ . DDSC_ACC_DELTA must be > 0. DDSC_ACC_DELTA must be > DDSC_ACC_MODULUS. This control is paged by the CHANNEL_PAGE bits in Register 0x008.	0x0	R/W
0x146	CHNL_GAIN0	[7:0]	CHNL_GAIN[7:0]		Sets the scalar channel gain value. This control is paged by the CHANNEL_PAGE bits in Register 0x008. Channel gain = $CHNL\_GAIN/2^{11}$ .	0x0	R/W
0x147	CHNL_GAIN1	[7:4]	RESERVED		Reserved.	0x0	R
		[3:0]	CHNL_GAIN[11:8]		Sets the scalar channel gain value. This control is paged by the CHANNEL_PAGE bits in Register 0x008. Channel gain = $CHNL\_GAIN/2^{11}$ .	0x8	R/W
0x148	DC_CAL_TONE0	[7:0]	DC_TEST_INPUT_AMPLITUDE[7:0]		DC test tone amplitude. This amplitude goes to both I and Q paths. Set these bits to 0x7FFF for a full-scale tone and ensure DDSC_EN_DC_INPUT in Register 0x130 Bit 0 is set to 1. This control is paged by the CHANNEL_PAGE control in Register 0x008.	0x0	R/W
0x149	DC_CAL_TONE1	[7:0]	DC_TEST_INPUT_AMPLITUDE[15:8]		DC test tone amplitude. This amplitude goes to both I and Q paths. Set to 0x7FFF for a full-scale tone and ensure that DDSC_EN_DC_INPUT (Register 0x130, Bit 0) is set to 1. This control is paged by the CHANNEL_PAGE bits in Register 0x008.	0x0	R/W
0x14B	PRBS	7	PRBS_GOOD_Q	1	DAC1 good data indicator. Correct PRBS sequence detected.	0x0	R

## REGISTER DETAILS

Table 60. Register Details

Addr.	Name	Bits	Bit Name	Settings	Description	Reset	Access
				0	Incorrect sequence detected. Sticky; reset to 1 by PRBS_RESET.		
		6	PRBS_GOOD_I	0	DAC0 good data indicator. Incorrect sequence detected. Sticky; reset to 1 by PRBS_RESET.	0x0	R
				1	Correct PRBS sequence detected.		
		5	RESERVED		Reserved.	0x0	R
		4	PRBS_INV_Q	0	DAC1 data inversion. Expect normal data.	0x1	R/W
				1	Expect inverted data.		
		3	PRBS_INV_I	0	DAC0 data inversion. Expect normal data.	0x0	R/W
				1	Expect inverted data.		
		2	PRBS_MODE	0	Select which PRBS polynomial is used for the datapath PRBS test. 7-bit: $x^7 + x^6 + 1$ .	0x0	R/W
				1	15-bit: $x^{15} + x^{14} + 1$ .		
		1	PRBS_RESET	0	Reset error counters. Normal operation.	0x0	R/W
				1	Reset counters.		
		0	PRBS_EN	0	Enable PRBS checker. Disable.	0x0	R/W
				1	Enable.		
0x14C	PRBS_ERROR_I	[7:0]	PRBS_COUNT_I		DAC0 PRBS error count.	0x0	R
0x14D	PRBS_ERROR_Q	[7:0]	PRBS_COUNT_Q		DAC1 PRBS error count.	0x0	R
0x14E	PRBS_CHANSEL	[7:3]	RESERVED		Reserved.	0x0	R
		[2:0]	PRBS_CHANSEL		Selects the channel to which the PRBS_GOOD_x and PRBS_COUNT_x bit field readbacks correspond.	0x7	R/W
				0	Select Channel 0 for PRBS_COUNT_x and PRBS_GOOD_x (Channel 0, DAC0).		
				1	Select Channel 1 for PRBS_COUNT_x and PRBS_GOOD_x (Channel 1, DAC0).		
				2	Select Channel 2 for PRBS_COUNT_x and PRBS_GOOD_x (Channel 2, DAC0).		
				3	Select Channel 3 for PRBS_COUNT_x and PRBS_GOOD_x (Channel 0, DAC1).		
				4	Select Channel 4 for PRBS_COUNT_x and PRBS_GOOD_x (Channel 1, DAC1).		
				5	Select Channel 5 for PRBS_COUNT_x and PRBS_GOOD_x (Channel 2, DAC1).		
				6	OR all channels for PRBS_GOOD_x, sum all channels for PRBS_COUNT_x.		
0x151	DECODE_MODE	[7:6]	RESERVED		Reserved.	0x0	R/W
		[5:4]	MSB_MODE		MSB shuffling control.	0x0	R/W
		[3:0]	RESERVED		Reserved.	0x0	R
0x1DE	SPI_ENABLE	[7:2]	RESERVED		Reserved.	0x0	R
		1	SPI_EN1		Enable SPI control.	0x1	R/W
		0	SPI_EN0		Enable SPI control.	0x1	R/W

## REGISTER DETAILS

Table 60. Register Details

Addr.	Name	Bits	Bit Name	Settings	Description	Reset	Access
0x1E2	DDSM_CAL_FTW0	[7:0]	DDSM_CAL_FTW[7:0]		FTW of the calibration accumulator. This control is paged by the MAINDAC_PAGE bits in Register 0x008.	0x0	R/W
0x1E3	DDSM_CAL_FTW1	[7:0]	DDSM_CAL_FTW[15:8]		FTW of the calibration accumulator. This control is paged by the MAINDAC_PAGE bits in Register 0x008.	0x0	R/W
0x1E4	DDSM_CAL_FTW2	[7:0]	DDSM_CAL_FTW[23:16]		FTW of the calibration accumulator. This control is paged by the MAINDAC_PAGE bits in Register 0x008.	0x0	R/W
0x1E5	DDSM_CAL_FTW3	[7:0]	DDSM_CAL_FTW[31:24]		FTW of the calibration accumulator. This control is paged by the MAINDAC_PAGE bits in Register 0x008.	0x0	R/W
0x1E6	DDSM_CAL_MODE_DEF	[7:3]	RESERVED		Reserved.	0x0	R
		2	DDSM_EN_CAL_ACC	0	Disabled (does not clock the calibration frequency accumulator).	0x0	R/W
				1	Enables (turns on the clock to the calibration frequency accumulator).		
		1	DDSM_EN_CAL_DC_INPUT	0	Mux in datapath signal to the input of the final DDS.	0x0	R/W
1	Mux in dc to the input of the final DDS.						
0x1E7	DATAPATH_NCO_SYNC_CFG	[7:2]	RESERVED		Reserved.	0x0	R
		1	ALL_NCO_SYNC_ACK	0	Acknowledge signal that all the active NCOs are loaded. This bit is the acknowledge indicator for both the START_NCO_SYNC bit (Bit 0 of this register) and the NCORST_AFTER_ROT_EN bit (Register 0x03B, Bit 4) method of resetting the NCOs. This control is paged by the MAINDAC_PAGE bits in Register 0x008.	0x0	R
				0	START_NCO_SYNC	Used to start the sync of the NCOs on a rising edge of the SPI bit or SYSREF± signal, depending on which is chosen as the update trigger. Upon receiving a trigger, the FTWs are loaded first, and then a synchronization occurs. This control is paged by the MAINDAC_PAGE bits in Register 0x008.	0x0
0x200	MASTER_PD	[7:1]	RESERVED		Reserved.	0x0	R
		0	SERDES_MASTER_PD		Powers down the entire JESD204B Rx analog (all eight channels and bias).	0x1	R/W
0x201	PHY_PD	[7:0]	PHY_PD		SPI override to power down the individual PHYs. Bit 0 controls the SERDIN0± PHY. Bit 1 controls the SERDIN1± PHY. Bit 2 controls the SERDIN2± PHY.	0xEE	R/W

## REGISTER DETAILS

Table 60. Register Details

Addr.	Name	Bits	Bit Name	Settings	Description	Reset	Access
0x203	GENERIC_PD	[7:2]	RESERVED		Bit 3 controls the SERDIN3± PHY. Bit 4 controls the SERDIN4± PHY. Bit 5 controls the SERDIN5± PHY. Bit 6 controls the SERDIN6± PHY. Bit 7 controls the SERDIN7± PHY.		
		1	PD_SYNCOUT0	0 1	Powers down the SYNCOUT0± driver. Enables the SYNCOUT0± output pins. Powers down the SYNCOUT0± output pins.	0x0	R/W
		0	PD_SYNCOUT1	0 1	Powers down the SYNCOUT1± driver. Enables the SYNCOUT1± output pins. Powers down the SYNCOUT1± output pins.	0x1	R/W
0x206	CDR_RESET	[7:1]	RESERVED		Reserved.	0x0	R
		0	CDR_PHY_RESET		PHY reset control bit. Set this bit to 1 to take the PHYs out of reset during device operation.	0x0	R/W
0x210	CBUS_ADDR	[7:0]	SERDES_CBUS_ADDR		SERDES configuration control register to set SERDES configuration address controls.	0x0	R/W
0x212	CBUS_WRSTROBE_PHY	[7:0]	SERDES_CBUS_WRO		SERDES configuration control register to commit the SERDES configuration controls written.	0x0	R/W
0x213	CBUS_WRSTROBE_OTHER	[7:1]	RESERVED		Reserved.	0x0	R
		0	SERDES_CBUS_WR1		SERDES configuration control register to commit the SERDES configuration controls written.	0x0	R/W
0x216	CBUS_WDATA	[7:0]	SERDES_CBUS_DATA		SERDES configuration control register to set the SERDES configuration control data.	0x0	R/W
0x240	EQ_BOOST_PHY_3_0	[7:6]	EQ_BOOST_PHY3	10 11	Equalizer setting for PHY 3 based on insertion loss of the system. Insertion loss ≤ 11 dB. Insertion loss > 11 dB.	0x3	R/W
				[5:4]	EQ_BOOST_PHY2		
		[3:2]	EQ_BOOST_PHY1	10 11	Equalizer setting for PHY 1 based on insertion loss of the system. Insertion loss ≤ 11 dB. Insertion loss > 11 dB.	0x3	R/W
		[1:0]	EQ_BOOST_PHY0	10 11	Equalizer setting for PHY 0 based on insertion loss of the system. Insertion loss ≤ 11 dB. Insertion loss > 11 dB.		
0x234	CDR_BITINVERSE		SEL_IF_PARDATAINV_DES_RC_CH RC_CH	0 1	Output data inversion bit controls. Set Bit x corresponding to PHY x to invert the bit polarity.  Not inverted. Inverted.	0x66	R/W
0x241	EQ_BOOST_PHY_7_4	[7:6]	EQ_BOOST_PHY7	10	Equalizer setting for PHY 7 based on insertion loss of the system. Insertion loss ≤ 11 dB.	0x3	R/W

## REGISTER DETAILS

Table 60. Register Details

Addr.	Name	Bits	Bit Name	Settings	Description	Reset	Access		
0x242	EQ_GAIN_PHY_3_0	[5:4]	EQ_BOOST_PHY6	11	Insertion loss > 11 dB.	0x3	R/W		
				10	Equalizer setting for PHY 6 based on insertion loss of the system.				
				11	Insertion loss ≤ 11 dB.				
		[3:2]	EQ_BOOST_PHY5	11	Insertion loss > 11 dB.	0x3	R/W		
				10	Equalizer setting for PHY 5 based on insertion loss of the system.				
				11	Insertion loss ≤ 11 dB.				
		[1:0]	EQ_BOOST_PHY4	11	Insertion loss > 11 dB.	0x3	R/W		
				10	Equalizer setting for PHY 4 based on insertion loss of the system.				
				11	Insertion loss ≤ 11 dB.				
0x243	EQ_GAIN_PHY_7_4	[7:6]	EQ_GAIN_PHY3	01	Equalizer gain for PHY 3 based on insertion loss of the system.	0x3	R/W		
				11	Insertion loss ≤ 11 dB.				
		[5:4]	EQ_GAIN_PHY2	01	Equalizer gain for PHY 2 based on insertion loss of the system.	0x3	R/W		
				11	Insertion loss ≤ 11 dB.				
		[3:2]	EQ_GAIN_PHY1	01	Equalizer gain for PHY 1 based on insertion loss of the system.	0x3	R/W		
				11	Insertion loss ≤ 11 dB.				
		[1:0]	EQ_GAIN_PHY0	01	Equalizer gain for PHY 0 based on insertion loss of the system.	0x3	R/W		
11	Insertion loss ≤ 11 dB.								
0x244	EQ_FB_PHY_0	[7:5]	RESERVED		Reserved.	0x0	R		
				[4:0]	EQ_PHY_0				SERDES equalizer setting for PHY0. Set this control to 0x1F for optimal performance.
		[7:5]	RESERVED				Reserved.	0x0	R
				[5:4]	EQ_GAIN_PHY6	01	Equalizer gain for PHY 6 based on insertion loss of the system.		
						11	Insertion loss ≤ 11 dB.		
		[3:2]	EQ_GAIN_PHY5	01	Equalizer gain for PHY 5 based on insertion loss of the system.				
				11	Insertion loss ≤ 11 dB.				
[1:0]	EQ_GAIN_PHY4	01	Equalizer gain for PHY 4 based on insertion loss of the system.						
		11	Insertion loss ≤ 11 dB.						

## REGISTER DETAILS

Table 60. Register Details

Addr.	Name	Bits	Bit Name	Settings	Description	Reset	Access
0x246	EQ_FB_PHY_2	[4:0]	EQ_PHY1		SERDES equalizer setting for PHY1. Set this control to 0x1F for optimal performance.	0x19	R/W
		[7:5]	RESERVED		Reserved.	0x0	R
0x247	EQ_FB_PHY_3	[4:0]	EQ_PHY2		SERDES equalizer setting for PHY2. Set this control to 0x1F for optimal performance.	0x19	R/W
		[7:5]	RESERVED		Reserved.	0x0	R
0x248	EQ_FB_PHY_4	[4:0]	EQ_PHY3		SERDES equalizer setting for PHY3. Set this control to 0x1F for optimal performance.	0x19	R/W
		[7:5]	RESERVED		Reserved.	0x0	R
0x249	EQ_FB_PHY_5	[4:0]	EQ_PHY4		SERDES equalizer setting for PHY4. Set this control to 0x1F for optimal performance.	0x19	R/W
		[7:5]	RESERVED		Reserved.	0x0	R
0x24A	EQ_FB_PHY_6	[4:0]	EQ_PHY5		SERDES equalizer setting for PHY5. Set this control to 0x1F for optimal performance.	0x19	R/W
		[7:5]	RESERVED		Reserved.	0x0	R
0x24B	EQ_FB_PHY_7	[4:0]	EQ_PHY6		SERDES equalizer setting for PHY6. Set this control to 0x1F for optimal performance.	0x19	R/W
		[7:5]	RESERVED		Reserved.	0x0	R
0x250	LBT_REG_CNTRL_0	[4:0]	EQ_PHY7		SERDES equalizer setting for PHY7. Set this control to 0x1F for optimal performance.	0x19	R/W
		[7:0]	EN_LBT_DES_RC_CH		Enable loopback test for desired physical lanes per PHY, with Bit x corresponding to PHY x.	0x0	R/W
0x251	LBT_REG_CNTRL_1	[7:2]	RESERVED		Reserved.	0x0	R
		1	EN_LBT_HALFRADE_DES_RC		Enables half rate mode for the loopback test. If this bit is set to 1, the output data rate = 2× the input clock frequency. If this bit is set to 0, the output data rate = the input clock frequency.	0x1	R/W
0x253	SYNCOUT0_CTRL	0	INIT_LBT_SYNC_DES_RC		Initiate the loopback test by toggling this bit from 0 to 1, then back to 0.	0x0	R/W
		[7:1]	RESERVED		Reserved.	0x0	R/W
0x254	SYNCOUT0_CTRL	0	SEL_SYNCOUT0_MODE	0 1	This control determines the output driver mode for the SYNCOUT0± pin operation. Both SYNCOUT0± and SYNCOUT1± must be set to the same mode of operation. SYNCOUT0± is set to CMOS output. SYNCOUT0± is set to LVDS output.	0x0	R/W
		[7:1]	RESERVED		Reserved.	0x0	R/W
0x254	SYNCOUT1_CTRL	0	SEL_SYNCOUT1_MODE	0 1	This control determines the output driver mode for the SYNCOUT1+ pin operation. Both SYNCOUT0± and SYNCOUT1+ must be set to the same mode of operation. SYNCOUT1+ is set to CMOS output. SYNCOUT1+ is set to LVDS output.	0x0	R/W
		[7:1]	RESERVED		Reserved.	0x0	R/W
0x280	PLL_ENABLE_CTRL	[7:3]	RESERVED		Reserved.	0x0	R
		2	LOLSTICKYCLEAR_LCPLL_RC		Clears out loss of lock bit.	0x0	R/W
		1	LDSYNTH_LCPLL_RC		Pulse high to start VCO calibration (without restarting the regulator or remeasuring the temperature).	0x0	R/W
		0	SERDES_PLL_STARTUP		SERDES circuitry blocks are powered off when this bit is set to 0. Set this bit to 1 at the end of the SERDES configuration writes. When this bit is set	0x1	R/W



## REGISTER DETAILS

Table 60. Register Details

Addr.	Name	Bits	Bit Name	Settings	Description	Reset	Access
					to 1, it powers up the SERDES PLL blocks and starts the LDO and calibration routine to lock the PLL automatically to the appropriate lane rate based on the JESD204B mode and interpolation options programmed in the device. The SERDES_PLL_LOCK bit (Register 0x281, Bit 0) reads 1 when the PLL achieves lock.		
0x281	PLL_STATUS	[7:1]	RESERVED		Reserved.	0x0	R
		0	SERDES_PLL_LOCK		PLL is locked when this bit is high.	0x0	R
0x300	GENERAL_JRX_CTRL_0	[7:4]	RESERVED		Reserved.	0x0	R
		3	LINK_MODE		Reads back 0 when in single-link mode and 1 when in dual-link mode.	0x0	R/W
		2	LINK_PAGE	0 1	Link paging. This bit selects which link register map is used. This paging affects Register 0x400 to Register 0x4BB. Page QBD0 for Link 0. Page QBD1 for Link 1.	0x0	R/W
		[1:0]	LINK_EN		These bits bring up the JESD204B digital Rx when all link parameters are programmed and all clocks are ready. Bit 0 applies to Link 0, whereas Bit 1 applies to Link 1. Link 1 is only available in dual-link mode.	0x0	R/W
0x302	DYN_LINK_LATENCY_0	[7:6]	RESERVED		Reserved.	0x0	R
		[5:0]	DYN_LINK_LATENCY_0		Dynamic link latency, Link 0. Latency between the LMFC Rx for Link 0 and the last arriving LMFC boundary in units of PCLK cycles.	0x0	R
0x303	DYN_LINK_LATENCY_1	[7:6]	RESERVED		Reserved.	0x0	R
		[5:0]	DYN_LINK_LATENCY_1		Dynamic link latency, Link 1. Latency between the LMFC Rx for Link 1 and the last arriving LMFC boundary in units of PCLK cycles.	0x0	R
0x304	LMFC_DELAY_0	[7:6]	RESERVED		Reserved.	0x0	R
		[5:0]	LMFC_DELAY_0		LMFC delay, Link 0. Delay from the LMFC to the LMFC Rx for Link 0 in units of PCLK cycles.	0x0	R/W
0x305	LMFC_DELAY_1	[7:6]	RESERVED		Reserved.	0x0	R
		[5:0]	LMFC_DELAY_1		LMFC delay, Link 1. Delay from the LMFC to the LMFC Rx for Link 1 in units of PCLK cycles.	0x0	R/W
0x306	LMFC_VAR_0	[7:6]	RESERVED		Reserved.	0x0	R
		[5:0]	LMFC_VAR_0		Variable delay buffer, Link 0. These bits set when data is read from a buffer to be consistent across links and power cycles (in units of PCLK cycles). The maximum value is 0xC.	0x3F	R/W
0x307	LMFC_VAR_1	[7:6]	RESERVED		Reserved.	0x0	R
		[5:0]	LMFC_VAR_1		Variable delay buffer, Link 1. These bits set when data is read from a buffer to be consistent across links and power cycles (in units of PCLK cycles). The maximum value is 0xC.	0x3F	R/W
0x308	XBAR_LN_0_1	[7:6]	RESERVED		Reserved.	0x0	R
		[5:3]	LOGICAL_LANE1_SRC	000 001 010 011	Logical Lane 1 source. These bits select a physical lane to be mapped onto Logical Lane 1. Data is from SERDIN0±. Data is from SERDIN1±. Data is from SERDIN2±. Data is from SERDIN3±.	0x1	R/W

## REGISTER DETAILS

Table 60. Register Details

Addr.	Name	Bits	Bit Name	Settings	Description	Reset	Access
				100	Data is from SERDIN4±.		
				101	Data is from SERDIN5±.		
				110	Data is from SERDIN6±.		
				111	Data is from SERDIN7±.		
		[2:0]	LOGICAL_LANE0_SRC		Logical Lane 0 source. These bits select a physical lane to be mapped onto Logical Lane 0.	0x0	R/W
				000	Data is from SERDIN0±.		
				001	Data is from SERDIN1±.		
				010	Data is from SERDIN2±.		
				011	Data is from SERDIN3±.		
				100	Data is from SERDIN4±.		
				101	Data is from SERDIN5±.		
				110	Data is from SERDIN6±.		
				111	Data is from SERDIN7±.		
0x309	XBAR_LN_2_3	[7:6]	RESERVED		Reserved.	0x0	R
		[5:3]	LOGICAL_LANE3_SRC		Logical Lane 3 source. These bits select a physical lane to be mapped onto Logical Lane 3.	0x3	R/W
				000	Data is from SERDIN0±.		
				001	Data is from SERDIN1±.		
				010	Data is from SERDIN2±.		
				011	Data is from SERDIN3±.		
				100	Data is from SERDIN4±.		
				101	Data is from SERDIN5±.		
				110	Data is from SERDIN6±.		
				111	Data is from SERDIN7±.		
		[2:0]	LOGICAL_LANE2_SRC		Logical Lane 2 source. These bits select a physical lane to be mapped onto Logical Lane 2.	0x2	R/W
				000	Data is from SERDIN0±.		
				001	Data is from SERDIN1±.		
				010	Data is from SERDIN2±.		
				011	Data is from SERDIN3±.		
				100	Data is from SERDIN4±.		
				101	Data is from SERDIN5±.		
				110	Data is from SERDIN6±.		
				111	Data is from SERDIN7±.		
0x30A	XBAR_LN_4_5	[7:6]	RESERVED		Reserved.	0x0	R
		[5:3]	LOGICAL_LANE5_SRC		Logical Lane 5 source. These bits select a physical lane to be mapped onto Logical Lane 5.	0x5	R/W
				000	Data is from SERDIN0±.		
				001	Data is from SERDIN1±.		
				010	Data is from SERDIN2±.		
				011	Data is from SERDIN3±.		
				100	Data is from SERDIN4±.		
				101	Data is from SERDIN5±.		
				110	Data is from SERDIN6±.		
				111	Data is from SERDIN7±.		
		[2:0]	LOGICAL_LANE4_SRC		Logical Lane 4 source. These bits select a physical lane to be mapped onto Logical Lane 4.	0x4	R/W
				000	Data is from SERDIN0±.		

## REGISTER DETAILS

Table 60. Register Details

Addr.	Name	Bits	Bit Name	Settings	Description	Reset	Access
				001	Data is from SERDIN1±.		
				010	Data is from SERDIN2±.		
				011	Data is from SERDIN3±.		
				100	Data is from SERDIN4±.		
				101	Data is from SERDIN5±.		
				110	Data is from SERDIN6±.		
				111	Data is from SERDIN7±.		
0x30B	XBAR_LN_6_7	[7:6]	RESERVED		Reserved.	0x0	R
		[5:3]	LOGICAL_LANE7_SRC		Logical Lane 7 source. These bits select a physical lane to be mapped onto Logical Lane 7.	0x7	R/W
				000	Data is from SERDIN0±.		
				001	Data is from SERDIN1±.		
				010	Data is from SERDIN2±.		
				011	Data is from SERDIN3±.		
				100	Data is from SERDIN4±.		
				101	Data is from SERDIN5±.		
				110	Data is from SERDIN6±.		
				111	Data is from SERDIN7±.		
		[2:0]	LOGICAL_LANE6_SRC		Logical Lane 6 source. These bits select a physical lane to be mapped onto Logical Lane 6.	0x6	R/W
				000	Data is from SERDIN0±.		
				001	Data is from SERDIN1±.		
				010	Data is from SERDIN2±.		
				011	Data is from SERDIN3±.		
				100	Data is from SERDIN4±.		
				101	Data is from SERDIN5±.		
				110	Data is from SERDIN6±.		
				111	Data is from SERDIN7±.		
0x30C	FIFO_STATUS_REG_0	[7:0]	LANE_FIFO_FULL		Bit x corresponds to FIFO full flag for data from SERDINx±.	0x0	R
0x30D	FIFO_STATUS_REG_1	[7:0]	LANE_FIFO_EMPTY		Bit x corresponds to FIFO empty flag for data from SERDINx±.	0x0	R
0x311	SYNCOUT0_GEN_0	[7:4]	RESERVED		Reserved.	0x0	R
		3	EOMF_MASK_1		Mask end of multiframe (EOMF) from QBD1. Assert SYNCOUT1± based on the loss of the multiframe synchronization.	0x0	R/W
				0	Do not assert SYNCOUT1± on loss of multiframe.		
				1	Assert SYNCOUT1± on loss of multiframe.		
		2	EOMF_MASK_0		Mask EOMF from QBD0. Assert SYNCOUT0± based on the loss of the multiframe synchronization.	0x0	R/W
				0	Do not assert SYNCOUT0± on loss of multiframe.		
				1	Assert SYNCOUT0± on loss of multiframe.		
		1	EOF_MASK_1		Mask EOF from QBD1. Assert SYNCOUT1± based on loss of frame synchronization.	0x0	R/W
				0	Do not assert SYNCOUT1± on loss of frame.		
				1	Assert SYNCOUT1± on loss of frame.		
		0	EOF_MASK_0		Mask EOF from QBD0. Assert SYNCOUT0± based on loss of frame synchronization.	0x0	R/W
				0	Do not assert SYNCOUT0± on loss of frame.		
				1	Assert SYNCOUT0± on loss of frame.		

## REGISTER DETAILS

Table 60. Register Details

Addr.	Name	Bits	Bit Name	Settings	Description	Reset	Access
0x312	SYNCOUT_GEN_1	[7:4]	SYNC_ERR_DUR		Duration of SYNCOUTx± low for the purposes of the synchronization error report. Duration = (0.5 + code) PCLK cycles. To most closely match the specified value, set these bits as close as possible to f/2 PCLK cycles. These bits are shared between SYNCOUT0± and SYNCOUT1±.	0x0	R/W
		[3:0]	RESERVED		Reserved.	0x0	R/W
0x315	PHY_PRBS_TEST_EN	[7:0]	PHY_TEST_EN	0	Enable PHY BER by ungating the clocks. PHY test disable.	0x0	R/W
				1	PHY test enable.		
0x316	PHY_PRBS_TEST_CTRL	7	RESERVED		Reserved.	0x0	R
			[6:4]	PHY_SRC_ERR_CNT	000 001 010 011 100 101 110 111	Report Lane 0 error count. Report Lane 1 error count. Report Lane 2 error count. Report Lane 3 error count. Report Lane 4 error count. Report Lane 5 error count. Report Lane 6 error count. Report Lane 7 error count.	0x0
		[3:2]	PHY_PRBS_PAT_SEL	00 01 10 11	Select PRBS pattern for PHY BER test. PRBS7. PRBS15. PRBS31. Not used.	0x0	R/W
		1	PHY_TEST_START	0 1	Starts and stops the PHY PRBS test. Test not started. Test started.	0x0	R/W
		0	PHY_TEST_RESET	0 1	Resets PHY PRBS test state machine and error counters. Not reset. Reset.	0x0	R/W
0x317	PHY_PRBS_TEST_THRESHOLD_LOBITS	[7:0]	PHY_PRBS_THRESHOLD_LOBITS		Bits[7:0] of the 24-bit threshold value to set the error flag for the PHY PRBS test.	0x0	R/W
0x318	PHY_PRBS_TEST_THRESHOLD_MIDBITS	[7:0]	PHY_PRBS_THRESHOLD_MIDBITS		Bits[15:8] of the 24-bit threshold value to set the error flag for the PHY PRBS test.	0x0	R/W
0x319	PHY_PRBS_TEST_THRESHOLD_HIBITS	[7:0]	PHY_PRBS_THRESHOLD_HIBITS		Bits[23:16] of the 24-bit threshold value to set the error flag for the PHY PRBS test.	0x0	R/W
0x31A	PHY_PRBS_TEST_ERRCNT_LOBITS	[7:0]	PHY_PRBS_ERRCNT_LOBITS		Bits[7:0] of the 24-bit reported PHY BER error count from the selected lane.	0x0	R
0x31B	PHY_PRBS_TEST_ERRCNT_MIDBITS	[7:0]	PHY_PRBS_ERRCNT_MIDBITS		Bits[15:8] of the 24-bit reported PHY BER error count from the selected lane.	0x0	R
0x31C	PHY_PRBS_TEST_ERRCNT_HIBITS	[7:0]	PHY_PRBS_ERRCNT_HIBITS		Bits[23:16] of the 24-bit reported PHY BER error count from the selected lane.	0x0	R
0x31D	PHY_PRBS_TEST_STATUS	[7:0]	PHY_PRBS_PASS		Reports PHY BER pass/fail for each lane. Bit x is high when Lane x passes.	0xFF	R
0x31E	PHY_DATA_	[7:2]	RESERVED		Reserved.	0x0	R

## REGISTER DETAILS

Table 60. Register Details

Addr.	Name	Bits	Bit Name	Settings	Description	Reset	Access
	SNAPSHOT_CTRL	1	PHY_GRAB_MODE	0 1	This bit determines whether to use the trigger to grab data. Grab data when PHY_GRAB_DATA is set. Grab data upon bit error.	0x0	R/W
		0	PHY_GRAB_DATA		Transitioning this bit from 0 to 1 causes the logic to store current receive data from one lane.	0x0	R/W
0x31F	PHY_SNAPSHOT_DATA_BYTE0	[7:0]	PHY_SNAPSHOT_DATA_BYTE0		Current data received. Represents PHY_SNAPSHOT_DATA[7:0].	0x0	R
0x320	PHY_SNAPSHOT_DATA_BYTE1	[7:0]	PHY_SNAPSHOT_DATA_BYTE1		Current data received. Represents PHY_SNAPSHOT_DATA[15:8].	0x0	R
0x321	PHY_SNAPSHOT_DATA_BYTE2	[7:0]	PHY_SNAPSHOT_DATA_BYTE2		Current data received. Represents PHY_SNAPSHOT_DATA[23:16].	0x0	R
0x322	PHY_SNAPSHOT_DATA_BYTE3	[7:0]	PHY_SNAPSHOT_DATA_BYTE3		Current data received. Represents PHY_SNAPSHOT_DATA[31:24].	0x0	R
0x323	PHY_SNAPSHOT_DATA_BYTE4	[7:0]	PHY_SNAPSHOT_DATA_BYTE4		Current data received. Represents PHY_SNAPSHOT_DATA[39:32].	0x0	R
0x32C	SHORT_TPL_TEST_0	[7:4]	SHORT_TPL_SP_SEL	0000 0001 0010 0011 0100 0101 0110 0111 1000 1001 1010 1011 1100 1101 1110 1111	Short transport layer sample select. Selects which sample to check from a specific DAC. Sample 0. Sample 1. Sample 2. Sample 3. Sample 4. Sample 5. Sample 6. Sample 7. Sample 8. Sample 9. Sample 10. Sample 11. Sample 12. Sample 13. Sample 14. Sample 15.	0x0	R/W
		[3:2]	SHORT_TPL_M_SEL	00 01 10	Short transport layer test channel select. Select which channel of the DAC to check. Channel 0. Channel 1. Channel 2.	0x0	R/W
		1	SHORT_TPL_TEST_RESET	0 1	Short transport layer test reset. Resets the result of short transport layer test. Not reset. Reset.	0x0	R/W
		0	SHORT_TPL_TEST_EN	0 1	Short transport layer test enable. Enable short transport layer test. Disable. Enable.	0x0	R/W
0x32D	SHORT_TPL_TEST_1	[7:0]	SHORT_TPL_REF_SP_LSB		Short transport layer reference sample, LSB. This bit field is the lower eight bits of the expected DAC sample during the short transport layer test and is	0x0	R/W

## REGISTER DETAILS

Table 60. Register Details

Addr.	Name	Bits	Bit Name	Settings	Description	Reset	Access
					used to compare with the received sample at the JESD204B Rx output.		
0x32E	SHORT_TPL_TEST_2	[7:0]	SHORT_TPL_REF_SP_MSB		Short transport layer test reference sample, MSB. This bit field is the upper eight bits of the expected DAC sample during the short transport layer test and is used to compare with the received sample at the JESD204B Rx output.	0x0	R/W
0x32F	SHORT_TPL_TEST_3	7	RESERVED		Reserved.	0x0	R/W
		6	SHORT_TPL_IQ_SAMPLE_SEL	0 1	Selects I or Q of the DAC to check the testing of the short transport layer. Select I data to test. Select Q data to test.		
		[5:1]	RESERVED		Reserved.	0x0	R/W
		0	SHORT_TPL_FAIL	0 1	Short transport layer test fail. This bit shows if the selected DAC sample matches the expected sample for the short transport layer test. If they match, the test passes; otherwise, the test fails. Test pass. Test fail.	0x0	R
0x334	JESD_BIT_INVERSE_CTRL	[7:0]	JESD_BIT_INVERSE		Logical lane invert. Each bit of this control inverts the JESD204B deserialized data from one specific JESD204B Rx PHY. Set Bit x high to invert the JESD204B deserialized data on Logical Lane x.	0x0	R/W
0x400	DID_REG	[7:0]	DID_RD		Received ILAS configuration on Lane 0. This control is paged by the LINK_PAGE control in Register 0x300.	0x0	R
0x401	BID_REG	[7:0]	BID_RD		Received ILAS configuration on Lane 0. This control is paged by the LINK_PAGE control in Register 0x300.	0x0	R
0x402	LID0_REG	7	RESERVED		Reserved.	0x0	R
		6	ADJDIR_RD		Received ILAS configuration on Lane 0. This control is paged by the LINK_PAGE control in Register 0x300.	0x0	R
		5	PHADJ_RD		Received ILAS configuration on Lane 0. This control is paged by the LINK_PAGE control in Register 0x300.	0x0	R
		[4:0]	LL_LID0		Received ILAS LID configuration on Lane 0. This control is paged by the LINK_PAGE control in Register 0x300.	0x0	R
0x403	SCR_L_REG	7	SCR_RD	0 1	Received ILAS configuration on Lane 0. This control is paged by the LINK_PAGE control in Register 0x300. Scrambling is disabled. Scrambling is enabled.	0x0	R
		[6:5]	RESERVED		Reserved.	0x0	R
		[4:0]	L_RD-1	00000 00001 00010 00011	Received ILAS configuration on Lane 0. This control is paged by the LINK_PAGE control in Register 0x300. 1 lane per converter device. 2 lanes per converter device. 3 lanes per converter device. 4 lanes per converter device.	0x0	R

## REGISTER DETAILS

Table 60. Register Details

Addr.	Name	Bits	Bit Name	Settings	Description	Reset	Access
0x404	F_REG	[7:0]	F_RD-1		Received ILAS configuration on Lane 0. This control is paged by the LINK_PAGE control in Register 0x300.	0x0	R
				0	1 octet per frame.		
				1	2 octets per frame.		
				10	3 octets per frame.		
				11	4 octets per frame.		
0x405	K_REG	[7:5]	RESERVED		Reserved.	0x0	R
		[4:0]	K_RD-1	00000 11111	Received ILAS configuration on Lane 0. This control is paged by the LINK_PAGE control in Register 0x300. Default value. 32 frames per multiframe.	0x0	R
0x406	M_REG	[7:0]	M_RD-1		Received ILAS configuration on Lane 0. This control is paged by the LINK_PAGE control in Register 0x300.	0x0	R
0x407	CS_N_REG	[7:6]	CS_RD		Received ILAS configuration on Lane 0. This control is paged by the LINK_PAGE control in Register 0x300.	0x0	R
		5	RESERVED		Reserved.	0x0	R
		[4:0]	N_RD-1		Received ILAS configuration on Lane 0. This control is paged by the LINK_PAGE control in Register 0x300.	0x0	R
0x408	NP_REG	[7:5]	SUBCLASSV_RD		Received ILAS configuration on Lane 0. This control is paged by the LINK_PAGE control in Register 0x300.	0x0	R
		[4:0]	NP_RD-1		Received ILAS configuration on Lane 0. This control is paged by the LINK_PAGE control in Register 0x300.	0x0	R
0x409	S_REG	[7:5]	JESDV_RD-1	000 001	Received ILAS configuration on Lane 0. This control is paged by the LINK_PAGE control in Register 0x300. JESD204A. JESD204B.	0x0	R
		[4:0]	S_RD-1		Received ILAS configuration on Lane 0. This control is paged by the LINK_PAGE control in Register 0x300.	0x0	R
0x40A	HD_CF_REG	7	HD_RD	0	Low density mode.	0x0	R
				1	High density mode.		
		[6:5]	RESERVED		Reserved.		
		[4:0]	CF_RD		Received ILAS configuration on Lane 0. This control is paged by the LINK_PAGE control in Register 0x300.	0x0	R
0x40B	RES1_REG	[7:0]	RES1_RD		Received ILAS configuration on Lane 0. This control is paged by the LINK_PAGE control in Register 0x300.	0x0	R
0x40C	RES2_REG	[7:0]	RES2_RD		Received ILAS configuration on Lane 0. This control is paged by the LINK_PAGE control in Register 0x300.	0x0	R

## REGISTER DETAILS

Table 60. Register Details

Addr.	Name	Bits	Bit Name	Settings	Description	Reset	Access
0x40D	CHECKSUM0_REG	[7:0]	LL_FCHK0		Received checksum during ILAS on Lane 0. This control is paged by the LINK_PAGE control in Register 0x300.	0x0	R
0x40E	COMPNUM0_REG	[7:0]	LL_FCMP0		Computed checksum on Lane 0. This control is paged by the LINK_PAGE control in Register 0x300.	0x0	R
0x412	LID1_REG	[7:5]	RESERVED		Reserved.	0x0	R
		[4:0]	LL_LID1		Received ILAS LID configuration on Lane 1. This control is paged by the LINK_PAGE control in Register 0x300.	0x0	R
0x415	CHECKSUM1_REG	[7:0]	LL_FCHK1		Received checksum during ILAS on Lane 1. This control is paged by the LINK_PAGE control in Register 0x300.	0x0	R
0x416	COMPNUM1_REG	[7:0]	LL_FCMP1		Computed checksum on Lane 1. This control is paged by the LINK_PAGE control in Register 0x300.	0x0	R
0x41A	LID2_REG	[7:5]	RESERVED		Reserved.	0x0	R
		[4:0]	LL_LID2		Received ILAS LID configuration on Lane 2. This control is paged by the LINK_PAGE control in Register 0x300.	0x0	R
0x41D	CHECKSUM2_REG	[7:0]	LL_FCHK2		Received checksum during ILAS on Lane 2. This control is paged by the LINK_PAGE control in Register 0x300.	0x0	R
0x41E	COMPNUM2_REG	[7:0]	LL_FCMP2		Computed checksum on Lane 2. This control is paged by the LINK_PAGE control in Register 0x300.	0x0	R
0x422	LID3_REG	[7:5]	RESERVED		Reserved.	0x0	R
		[4:0]	LL_LID3		Received ILAS LID configuration on Lane 3. This control is paged by the LINK_PAGE control in Register 0x300.	0x0	R
0x425	CHECKSUM3_REG	[7:0]	LL_FCHK3		Received checksum during ILAS on Lane 3. This control is paged by the LINK_PAGE control in Register 0x300.	0x0	R
0x426	COMPNUM3_REG	[7:0]	LL_FCMP3		Computed checksum on Lane 3. This control is paged by the LINK_PAGE control in Register 0x300.	0x0	R
0x42A	LID4_REG	[7:5]	RESERVED		Reserved.	0x0	R
		[4:0]	LL_LID4		Received ILAS LID configuration on Lane 4. This control is paged by the LINK_PAGE control in Register 0x300.	0x0	R
0x42D	CHECKSUM4_REG	[7:0]	LL_FCHK4		Received checksum during ILAS on Lane 4. This control is paged by the LINK_PAGE control in Register 0x300.	0x0	R
0x42E	COMPNUM4_REG	[7:0]	LL_FCMP4		Computed checksum on Lane 4. This control is paged by the LINK_PAGE control in Register 0x300.	0x0	R
0x432	LID5_REG	[7:5]	RESERVED		Reserved.	0x0	R
		[4:0]	LL_LID5		Received ILAS LID configuration on Lane 5. This control is paged by the LINK_PAGE control in Register 0x300.	0x0	R
0x435	CHECKSUM5_REG	[7:0]	LL_FCHK5		Received checksum during ILAS on Lane 5. This control is paged by the LINK_PAGE control in Register 0x300.	0x0	R
0x436	COMPNUM5_REG	[7:0]	LL_FCMP5		Computed checksum on Lane 5. This control is paged by the LINK_PAGE control in Register 0x300.	0x0	R
0x43A	LID6_REG	[7:5]	RESERVED		Reserved.	0x0	R



## REGISTER DETAILS

Table 60. Register Details

Addr.	Name	Bits	Bit Name	Settings	Description	Reset	Access
		[4:0]	LL_LID6		Received ILAS LID configuration on Lane 6. This control is paged by the LINK_PAGE control in Register 0x300.	0x0	R
0x43D	CHECKSUM6_REG	[7:0]	LL_FCHK6		Received checksum during ILAS on Lane 6. This control is paged by the LINK_PAGE control in Register 0x300.	0x0	R
0x43E	COMPSUM6_REG	[7:0]	LL_FCMP6		Computed checksum on Lane 6. This control is paged by the LINK_PAGE control in Register 0x300.	0x0	R
0x442	LID7_REG	[7:5]	RESERVED		Reserved.	0x0	R
		[4:0]	LL_LID7		Received ILAS LID configuration on Lane 7. This control is paged by the LINK_PAGE control in Register 0x300.	0x0	R
0x445	CHECKSUM7_REG	[7:0]	LL_FCHK7		Received checksum during ILAS on Lane 7. This control is paged by the LINK_PAGE control in Register 0x300.	0x0	R
0x446	COMPSUM7_REG	[7:0]	LL_FCMP7		Computed checksum on Lane 7. This control is paged by the LINK_PAGE control in Register 0x300.	0x0	R
0x450	ILS_DID	[7:0]	DID		Device (link) identification number. This control is paged by the LINK_PAGE control in Register 0x300.	0x0	R/W
0x451	ILS_BID	[7:0]	BID		Bank ID, extension to DID. This control is paged by the LINK_PAGE control in Register 0x300. This signal must only be programmed while the QBD is held in soft reset (Register 0x475, Bit 3), and must not be changed during normal operation.	0x0	R/W
0x452	ILS_LID0	7	RESERVED		Reserved.	0x0	R
		6	ADJDIR		Direction to adjust the DAC LMFC. Link information is received on Link Lane 0 as specified in Section 8.3 of JESD204B. Only Link 0 is supported. This control is paged by the LINK_PAGE control in Register 0x300.	0x0	R/W
		5	PHADJ		Phase adjustment request to the DAC. Only Link 0 is supported. This control is paged by the LINK_PAGE control in Register 0x300.	0x0	R/W
		[4:0]	LID0		Lane identification number (within link). This control is paged by the LINK_PAGE control in Register 0x300. This signal must only be programmed while the QBD is held in soft reset (Register 0x475, Bit 3), and must not be changed during normal operation.	0x0	R/W
0x453	ILS_SCR_L	7	SCR	0	Scramble enabled for the link. This control is paged by the LINK_PAGE control in Register 0x300.	0x1	R/W
				1	Descrambling is disabled.		
		[6:5]	RESERVED		Reserved.	0x0	R
		[4:0]	L-1		Number of lanes per converter (minus 1). This control is paged by the LINK_PAGE control in Register 0x300.	0x7	R/W
0x454	ILS_F	[7:0]	F-1		Number of octets per frame per lane (minus 1). This control is paged by the LINK_PAGE control in Register 0x300.	0x0	R/W
0x455	ILS_K	[7:5]	RESERVED		Reserved.	0x0	R
		[4:0]	K-1	11111	Number of frames per multiframe (minus 1). This control is paged by the LINK_PAGE control in Register 0x300. 32 frames per multiframe.	0x1F	R/W

## REGISTER DETAILS

Table 60. Register Details

Addr.	Name	Bits	Bit Name	Settings	Description	Reset	Access
0x456	ILS_M	[7:0]	M-1		Number of subchannels per link (minus 1). This control is paged by the LINK_PAGE control in Register 0x300.	0x1	R/W
0x457	ILS_CS_N	[7:6]	CS		Number of control bits per sample. Only Link 0 is supported. This control is paged by the LINK_PAGE control in Register 0x300.	0x0	R
		5	RESERVED		Reserved.	0x0	R
		[4:0]	N-1		Converter resolution (minus 1). This control is paged by the LINK_PAGE control in Register 0x300.	0xF	R/W
0x458	ILS_NP	[7:5]	SUBCLASSV	000 001	Device subclass version. This control is paged by the LINK_PAGE control in Register 0x300. Subclass 0. Subclass 1.	0x0	R/W
		[4:0]	NP-1		Total number of bits per sample (minus 1). This control is paged by the LINK_PAGE control in Register 0x300.	0xF	R/W
0x459	ILS_S	[7:5]	JESDV	000 001	JESD204 version. This control is paged by the LINK_PAGE control in Register 0x300. JESD204A. JESD204B.	0x0	R/W
		[4:0]	S-1		Number of samples per converter per frame cycle (minus 1). This control is paged by the LINK_PAGE control in Register 0x300.	0x1	R/W
0x45A	ILS_HD_CF	7	HD	0 1	High density format, always set to 1. This control is paged by the LINK_PAGE control in Register 0x300. Low density mode. High density mode.	0x1	R
				[6:5]	RESERVED		Reserved.
		[4:0]	CF		Number of control bits per sample. Only Link 0 is supported. This control is paged by the LINK_PAGE control in Register 0x300.	0x0	R
0x45B	ILS_RES1	[7:0]	RES1		Reserved field 1. This control is paged by the LINK_PAGE control in Register 0x300.	0x0	R/W
0x45C	ILS_RES2	[7:0]	RES2		Reserved field 2. This control is paged by the LINK_PAGE control in Register 0x300.	0x0	R/W
0x45D	ILS_CHECKSUM	[7:0]	FCHK0		Calculated link configuration checksum. This control is paged by the LINK_PAGE control in Register 0x300. This signal must only be programmed while the QBD is held in soft reset (Register 0x475, Bit 3), and must not be changed during normal operation.	0x0	R/W
0x46C	LANE_DESKEW	7	ILD7	0 1	Interlane deskew status for Lane 7. This control is paged by the LINK_PAGE control in Register 0x300. Deskew failed. Deskew achieved.	0x0	R
				6	ILD6	0 1	Interlane deskew status for Lane 6. This control is paged by the LINK_PAGE control in Register 0x300. Deskew failed. Deskew achieved.
		5	ILD5	0 1	Interlane deskew status for Lane 5. This control is paged by the LINK_PAGE control in Register 0x300. Deskew failed. Deskew achieved.	0x0	R

## REGISTER DETAILS

Table 60. Register Details

Addr.	Name	Bits	Bit Name	Settings	Description	Reset	Access
		4	ILD4	0 1	Interlane deskew status for Lane 4. This control is paged by the LINK_PAGE control in Register 0x300. Deskew failed. Deskew achieved.	0x0	R
		3	ILD3	0 1	Interlane deskew status for Lane 3. This control is paged by the LINK_PAGE control in Register 0x300. Deskew failed. Deskew achieved.	0x0	R
		2	ILD2	0 1	Interlane deskew status for Lane 2. This control is paged by the LINK_PAGE control in Register 0x300. Deskew failed. Deskew achieved.	0x0	R
		1	ILD1	0 1	Interlane deskew status for Lane 1. This control is paged by the LINK_PAGE control in Register 0x300. Deskew failed. Deskew achieved.	0x0	R
		0	ILD0	0 1	Interlane deskew status for Lane 0. This control is paged by the LINK_PAGE control in Register 0x300. Deskew failed. Deskew achieved.	0x0	R
0x46D	BAD_DISPARIY	7	BDE7	0 1	Bad disparity errors status for Lane 7. This control is paged by the LINK_PAGE control in Register 0x300. Error count < ETH[7:0] value. Error count ≥ ETH[7:0] value.	0x0	R
		6	BDE6	0 1	Bad disparity errors status for Lane 6. This control is paged by the LINK_PAGE control in Register 0x300. Error count < ETH[7:0] value. Error count ≥ ETH[7:0] value.	0x0	R
		5	BDE5	0 1	Bad disparity errors status for Lane 5. This control is paged by the LINK_PAGE control in Register 0x300. Error count < ETH[7:0] value. Error count ≥ ETH[7:0] value.	0x0	R
		4	BDE4	0 1	Bad disparity errors status for Lane 4. This control is paged by the LINK_PAGE control in Register 0x300. Error count < ETH[7:0] value. Error count ≥ ETH[7:0] value.	0x0	R
		3	BDE3	0 1	Bad disparity errors status for Lane 3. This control is paged by the LINK_PAGE control in Register 0x300. Error count < ETH[7:0] value. Error count ≥ ETH[7:0] value.	0x0	R
		2	BDE2	0 1	Bad disparity errors status for Lane 2. This control is paged by the LINK_PAGE control in Register 0x300. Error count < ETH[7:0] value. Error count ≥ ETH[7:0] value.	0x0	R
		1	BDE1	0 1	Bad disparity errors status for Lane 1. This control is paged by the LINK_PAGE control in Register 0x300. Error count < ETH[7:0] value. Error count ≥ ETH[7:0] value.	0x0	R
		0	BDE0		Bad disparity errors status for Lane 0. This control is paged by the LINK_PAGE control in Register 0x300.	0x0	R

## REGISTER DETAILS

Table 60. Register Details

Addr.	Name	Bits	Bit Name	Settings	Description	Reset	Access
0x46E	NOT_IN_TABLE	7	NIT7	0	Error count < ETH[7:0] value.	0x0	R
				1	Error count ≥ ETH[7:0] value.		
		6	NIT6	0	Error count < ETH[7:0] value.	0x0	R
				1	Error count ≥ ETH[7:0] value.		
		5	NIT5	0	Error count < ETH[7:0] value.	0x0	R
				1	Error count ≥ ETH[7:0] value.		
		4	NIT4	0	Error count < ETH[7:0] value.	0x0	R
				1	Error count ≥ ETH[7:0] value.		
		3	NIT3	0	Error count < ETH[7:0] value.	0x0	R
				1	Error count ≥ ETH[7:0] value.		
		2	NIT2	0	Error count < ETH[7:0] value.	0x0	R
				1	Error count ≥ ETH[7:0] value.		
		1	NIT1	0	Error count < ETH[7:0] value.	0x0	R
				1	Error count ≥ ETH[7:0] value.		
		0	NIT0	0	Error count < ETH[7:0] value.	0x0	R
				1	Error count ≥ ETH[7:0] value.		
0x46F	UNEXPECTED_KCHAR	7	UEK7	0	Error count < ETH[7:0] value.	0x0	R
				1	Error count ≥ ETH[7:0] value.		
		6	UEK6	0	Error count < ETH[7:0] value.	0x0	R
				1	Error count ≥ ETH[7:0] value.		
		5	UEK5	0	Error count < ETH[7:0] value.	0x0	R
				1	Error count ≥ ETH[7:0] value.		

## REGISTER DETAILS

Table 60. Register Details

Addr.	Name	Bits	Bit Name	Settings	Description	Reset	Access
		4	UEK4	0 1	Unexpected K character errors status, Lane 4. This control is paged by the LINK_PAGE control in Register 0x300. Error count < ETH[7:0] value. Error count ≥ ETH[7:0] value.	0x0	R
		3	UEK3	0 1	Unexpected K character errors status, Lane 3. This control is paged by the LINK_PAGE control in Register 0x300. Error count < ETH[7:0] value. Error count ≥ ETH[7:0] value.	0x0	R
		2	UEK2	0 1	Unexpected K character errors status, Lane 2. This control is paged by the LINK_PAGE control in Register 0x300. Error count < ETH[7:0] value. Error count ≥ ETH[7:0] value.	0x0	R
		1	UEK1	0 1	Unexpected K character errors status, Lane 1. This control is paged by the LINK_PAGE control in Register 0x300. Error count < ETH[7:0] value. Error count ≥ ETH[7:0] value.	0x0	R
		0	UEK0	0 1	Unexpected K character errors status, Lane 0. This control is paged by the LINK_PAGE control in Register 0x300. Error count < ETH[7:0] value. Error count ≥ ETH[7:0] value.	0x0	R
0x470	CODE_GRP_SYNC	7	CGS7	0 1	Code group synchronization status for Lane 7. This control is paged by the LINK_PAGE control in Register 0x300. Synchronization lost. Synchronization achieved.	0x0	R
		6	CGS6	0 1	Code group synchronization status for Lane 6. This control is paged by the LINK_PAGE control in Register 0x300. Synchronization lost. Synchronization achieved.	0x0	R
		5	CGS5	0 1	Code group synchronization status for Lane 5. This control is paged by the LINK_PAGE control in Register 0x300. Synchronization lost. Synchronization achieved.	0x0	R
		4	CGS4	0 1	Code group synchronization status for Lane 4. This control is paged by the LINK_PAGE control in Register 0x300. Synchronization lost. Synchronization achieved.	0x0	R
		3	CGS3	0 1	Code group synchronization status for Lane 3. This control is paged by the LINK_PAGE control in Register 0x300. Synchronization lost. Synchronization achieved.	0x0	R

## REGISTER DETAILS

Table 60. Register Details

Addr.	Name	Bits	Bit Name	Settings	Description	Reset	Access		
0x471	FRAME_SYNC	2	CGS2	0	Code group synchronization status for Lane 2. This control is paged by the LINK_PAGE control in Register 0x300. Synchronization lost.	0x0	R		
				1	Synchronization achieved.				
		1	CGS1	0	Code group synchronization status for Lane 1. This control is paged by the LINK_PAGE control in Register 0x300. Synchronization lost.	0x0	R		
				1	Synchronization achieved.				
		0	CGS0	0	Code group synchronization status for Lane 0. This control is paged by the LINK_PAGE control in Register 0x300. Synchronization lost.	0x0	R		
				1	Synchronization achieved.				
		0x471	FRAME_SYNC	7	FS7	0	Frame synchronization status for Lane 7. This control is paged by the LINK_PAGE control in Register 0x300. Synchronization lost.	0x0	R
						1	Synchronization achieved.		
				6	FS6	0	Frame synchronization status for Lane 6. This control is paged by the LINK_PAGE control in Register 0x300. Synchronization lost.	0x0	R
1	Synchronization achieved.								
5	FS5			0	Frame synchronization status for Lane 5. This control is paged by the LINK_PAGE control in Register 0x300. Synchronization lost.	0x0	R		
				1	Synchronization achieved.				
4	FS4			0	Frame synchronization status for Lane 4. This control is paged by the LINK_PAGE control in Register 0x300. Synchronization lost.	0x0	R		
				1	Synchronization achieved.				
3	FS3	0	Frame synchronization status for Lane 3. This control is paged by the LINK_PAGE control in Register 0x300. Synchronization lost.	0x0	R				
		1	Synchronization achieved.						
2	FS2	0	Frame synchronization status for Lane 2. This control is paged by the LINK_PAGE control in Register 0x300. Synchronization lost.	0x0	R				
		1	Synchronization achieved.						
1	FS1	0	Frame synchronization status for Lane 1. This control is paged by the LINK_PAGE control in Register 0x300. Synchronization lost.	0x0	R				
		1	Synchronization achieved.						

## REGISTER DETAILS

Table 60. Register Details

Addr.	Name	Bits	Bit Name	Settings	Description	Reset	Access
		0	FS0		Frame synchronization status for Lane 0. This control is paged by the LINK_PAGE control in Register 0x300.	0x0	R
				0	Synchronization lost.		
0x472	GOOD_CHECKSUM	7	CKS7	0	Computed checksum status for Lane 7. This control is paged by the LINK_PAGE control in Register 0x300.	0x0	R
				1	Checksum is incorrect.		
		6	CKS6	0	Computed checksum status for Lane 6. This control is paged by the LINK_PAGE control in Register 0x300.	0x0	R
				1	Checksum is incorrect.		
		5	CKS5	0	Computed checksum status for Lane 5. This control is paged by the LINK_PAGE control in Register 0x300.	0x0	R
				1	Checksum is incorrect.		
		4	CKS4	0	Computed checksum status for Lane 4. This control is paged by the LINK_PAGE control in Register 0x300.	0x0	R
				1	Checksum is incorrect.		
		3	CKS3	0	Computed checksum status for Lane 3. This control is paged by the LINK_PAGE control in Register 0x300.	0x0	R
1	Checksum is incorrect.						
2	CKS2	0	Computed checksum status for Lane 2. This control is paged by the LINK_PAGE control in Register 0x300.	0x0	R		
		1	Checksum is incorrect.				
1	CKS1	0	Computed checksum status for Lane 1. This control is paged by the LINK_PAGE control in Register 0x300.	0x0	R		
		1	Checksum is incorrect.				
0	CKS0	0	Computed checksum status for Lane 0. This control is paged by the LINK_PAGE control in Register 0x300.	0x0	R		
		1	Checksum is incorrect.				
0x473	INIT_LANE_SYNC	7	ILS7		Initial lane synchronization status for Lane 7. This control is paged by the LINK_PAGE control in Register 0x300.	0x0	R
				0	Synchronization lost.		
		6	ILS6	0	Initial lane synchronization status for Lane 6. This control is paged by the LINK_PAGE control in Register 0x300.	0x0	R
1	Synchronization lost.						
5	ILS5	0	Initial lane synchronization status for Lane 5. This control is paged by the LINK_PAGE control in Register 0x300.	0x0	R		
		1	Synchronization lost.				

## REGISTER DETAILS

Table 60. Register Details

Addr.	Name	Bits	Bit Name	Settings	Description	Reset	Access
				1	Synchronization achieved.		
		4	ILS4	0 1	Initial lane synchronization status for Lane 4. This control is paged by the LINK_PAGE control in Register 0x300. Synchronization lost. Synchronization achieved.	0x0	R
		3	ILS3	0 1	Initial lane synchronization status for Lane 3. This control is paged by the LINK_PAGE control in Register 0x300. Synchronization lost. Synchronization achieved.	0x0	R
		2	ILS2	0 1	Initial lane synchronization status for Lane 2. This control is paged by the LINK_PAGE control in Register 0x300. Synchronization lost. Synchronization achieved.	0x0	R
		1	ILS1	0 1	Initial lane synchronization status for Lane 1. This control is paged by the LINK_PAGE control in Register 0x300. Synchronization lost. Synchronization achieved.	0x0	R
		0	ILS0	0 1	Initial lane synchronization status for Lane 0. This control is paged by the LINK_PAGE control in Register 0x300. Synchronization lost. Synchronization achieved.	0x0	R
0x475	CTRLREG0	[7:4]	RESERVED		Reserved.	0x0	R/W
		3	SOFTTRST		QBD soft reset. Active high synchronous reset. Resets all hardware to power-on state. This control is paged by the LINK_PAGE control in Register 0x300.	0x0	R/W
		2	FORCESYNCREQ		Command from application to assert a synchronization request. Active high. This control is paged by the LINK_PAGE control in Register 0x300.	0x0	R/W
		1	RESERVED		Reserved.	0x0	R
		0	REPL_FRM_ENA		When this level input is set, it enables the replacement of frames received in error. This control is paged by the LINK_PAGE control in Register 0x300. This signal must only be programmed while the QBD is held in soft reset (Register 0x475, Bit 3), and must not be changed during normal operation.	0x1	R/W
0x476	CTRLREG1	[7:5]	RESERVED		Reserved.	0x0	R
		4	QUAL_RDERR	0 1	Error reporting behavior for concurrent not in table (NIT) and running disparity (RD) errors. This control is paged by the LINK_PAGE control in Register 0x300. Set this bit to 1. This signal must only be programmed while the QBD is held in soft reset (Register 0x475, Bit 3), and must not be changed during normal operation. NIT has no effect on RD error. NIT error masks concurrent with RD error.	0x1	R/W
		[3:1]	RESERVED		Reserved.	0x0	R/W



## REGISTER DETAILS

Table 60. Register Details

Addr.	Name	Bits	Bit Name	Settings	Description	Reset	Access
		0	FCHK_N	0 1	Checksum calculation method. This control is paged by the LINK_PAGE control in Register 0x300. This signal must only be programmed while the QBD is held in soft reset (Register 0x475, Bit 3), and must not be changed during normal operation. Checksum is calculated by summing the individual fields in the link configuration table as defined in Section 8.3, Table 20 of the JESD204B standard. Checksum is calculated by summing the registers containing the packed link configuration fields (sum of Register 0x450 to Register 0x45A, modulo 256).	0x0	R/W
0x477	CTRLREG2	7	ILS_MODE	0 1	Data link layer test mode is enabled when this bit is set to 1. CGS pattern is followed by a perpetual ILAS sequence. This control is paged by the LINK_PAGE control in Register 0x300. This signal must only be programmed while the QBD is held in soft reset (Register 0x475, Bit 3), and must not be changed during normal operation. Normal mode. CGS pattern is followed by a perpetual ILAS sequence.	0x0	R/W
		6	RESERVED		Reserved.	0x0	R/W
		5	REPDATATEST		Repetitive data test enable using the JTSPAT pattern. To enable the test, Bit 7 of this register must = 0. This control is paged by the LINK_PAGE control in Register 0x300. This signal must only be programmed while the QBD is held in soft reset (Register 0x475, Bit 3), and must not be changed during normal operation.	0x0	R/W
		4	QUETESTERR	0 1	Queue test error mode. This control is paged by the LINK_PAGE control in Register 0x300. This signal must only be programmed while the QBD is held in soft reset (Register 0x475, Bit 3), and must not be changed during normal operation. When this bit = 0, simultaneous errors on multiple lanes are reported as one error. Selected when this bit = 1 and when REPDATATEST = 1. Detected errors from all lanes are trapped in a counter and sequentially signaled on SYNCOUTx±.	0x0	R/W
		3	AR_ECNTN		Automatic reset of error counter. The error counter that causes assertion of SYNCOUTx± is automatically reset to 0 when AR_ECNTN = 1. All other counters are unaffected. This control is paged by the LINK_PAGE control in Register 0x300. This signal must only be programmed while the QBD is held in soft reset (Register 0x475, Bit 3), and must not be changed during normal operation.	0x0	R/W
		[2:0]	RESERVED		Reserved.	0x0	R
0x478	KVAL	[7:0]	KSYNC		Number of 4 × K multiframes during ILAS. This control is paged by the LINK_PAGE control in Register 0x300. This signal must only be programmed while the QBD is held in soft reset (Register 0x475, Bit 3), and must not be changed during normal operation.	0x1	R/W

## REGISTER DETAILS

Table 60. Register Details

Addr.	Name	Bits	Bit Name	Settings	Description	Reset	Access
0x47C	ERRORTHRES	[7:0]	ETH		Error counter threshold value. These bits set when a SYNCOUTx± error or IRQx interrupt is sent due to BD, NIT, or UEK errors. This control is paged by the LINK_PAGE control in Register 0x300. This signal must only be programmed while the QBD is held in soft reset (Register 0x475, Bit 3), and must not be changed during normal operation.	0xFF	R/W
0x47D	SYNC_ASSERT_MASK	[7:3]	RESERVED		Reserved.	0x0	R
		[2:0]	SYNC_ASSERT_MASK		SYNCOUTx± assertion enable mask for BD, NIT, and UEK error conditions. This control is paged by the LINK_PAGE control in Register 0x300. Active high, SYNCOUTx± assertion enable mask for BD, NIT, and UEK error conditions, respectively. When an error counter, in any lane, has reached the error threshold count, ETH[7:0], and the corresponding SYNC_ASSERT_MASK bit is set, SYNCOUTx± is asserted. The mask bits are as follows (note that the bit sequence is reversed with respect to the other error count controls and the error counters): Bit 2 = bad disparity error (BDE). Bit 1 = not in table error (NIT). Bit 0 = unexpected K character error (UEK).	0x7	R/W
0x480	ECNT_CTRL0	[7:6]	RESERVED		Reserved.	0x0	R
		[5:3]	ECNT_ENA0		Error counter enables for Lane 0. This control is paged by the LINK_PAGE control in Register 0x300. Counters of each lane are addressed as follows: Bit 5 = unexpected K character error (UEK). Bit 4 = not in table error (NIT). Bit 3 = bad disparity error (BDE).	0x7	R/W
		[2:0]	ECNT_RST0		Reset error counters for Lane 0. This control is paged by the LINK_PAGE control in Register 0x300. Counters of each lane are addressed as follows: Bit 2 = bad disparity error (BDE). Bit 1 = not in table error (NIT). Bit 0 = unexpected K character error (UEK).	0x7	R/W
0x481	ECNT_CTRL1	[7:6]	RESERVED		Reserved.	0x0	R
		[5:3]	ECNT_ENA1		Error counter enables for Lane 1. This control is paged by the LINK_PAGE control in Register 0x300. Counters of each lane are addressed as follows: Bit 5 = unexpected K character error (UEK). Bit 4 = not in table error (NIT). Bit 3 = bad disparity error (BDE).	0x7	R/W
		[2:0]	ECNT_RST1		Reset error counters for Lane 1. This control is paged by the LINK_PAGE control in Register 0x300. Counters of each lane are addressed as follows: Bit 2 = unexpected K character error (UEK). Bit 1 = not in table error (NIT). Bit 0 = bad disparity error (BDE).	0x7	R/W
0x482	ECNT_CTRL2	[7:6]	RESERVED		Reserved.	0x0	R

## REGISTER DETAILS

Table 60. Register Details

Addr.	Name	Bits	Bit Name	Settings	Description	Reset	Access
		[5:3]	ECNT_ENA2		Error counter enables for Lane 2. This control is paged by the LINK_PAGE control in Register 0x300. Counters of each lane are addressed as follows: Bit 5 = unexpected K character error (UEK). Bit 4 = not in table error (NIT). Bit 3 = bad disparity error (BDE).	0x7	R/W
		[2:0]	ECNT_RST2		Reset error counters for Lane 2. This control is paged by the LINK_PAGE control in Register 0x300. Counters of each lane are addressed as follows: Bit 2 = unexpected K character error (UEK). Bit 1 = not in table error (NIT). Bit 0 = bad disparity error (BDE).	0x7	R/W
0x483	ECNT_CTRL3	[7:6]	RESERVED		Reserved.	0x0	R
		[5:3]	ECNT_ENA3		Error counter enables for Lane 3. This control is paged by the LINK_PAGE control in Register 0x300. Counters of each lane are addressed as follows: Bit 5 = unexpected K character error (UEK). Bit 4 = not in table error (NIT). Bit 3 = bad disparity error (BDE).	0x7	R/W
		[2:0]	ECNT_RST3		Reset error counters for Lane 3. This control is paged by the LINK_PAGE control in Register 0x300. Counters of each lane are addressed as follows: Bit 2 = unexpected K character error (UEK). Bit 1 = not in table error (NIT). Bit 0 = bad disparity error (BDE).	0x7	R/W
0x484	ECNT_CTRL4	[7:6]	RESERVED		Reserved.	0x0	R
		[5:3]	ECNT_ENA4		Error counter enables for Lane 4. This control is paged by the LINK_PAGE control in Register 0x300. Counters of each lane are addressed as follows: Bit 5 = unexpected K character error (UEK). Bit 4 = not in table error (NIT). Bit 3 = bad disparity error (BDE).	0x7	R/W
		[2:0]	ECNT_RST4		Reset error counters for Lane 4. This control is paged by the LINK_PAGE control in Register 0x300. Counters of each lane are addressed as follows: Bit 2 = unexpected K character error (UEK). Bit 1 = not in table error (NIT). Bit 0 = bad disparity error (BDE).	0x7	R/W
0x485	ECNT_CTRL5	[7:6]	RESERVED		Reserved.	0x0	R
		[5:3]	ECNT_ENA5		Error counter enables for Lane 5. This control is paged by the LINK_PAGE control in Register 0x300. Counters of each lane are addressed as follows: Bit 5 = unexpected K character error (UEK). Bit 4 = not in table error (NIT). Bit 3 = bad disparity error (BDE).	0x7	R/W
		[2:0]	ECNT_RST5		Reset error counters for Lane 5. This control is paged by the LINK_PAGE control in Register 0x300. Counters of each lane are addressed as follows: Bit 2 = unexpected K character error (UEK). Bit 1 = not in table error (NIT). Bit 0 = bad disparity error (BDE).	0x7	R/W

## REGISTER DETAILS

Table 60. Register Details

Addr.	Name	Bits	Bit Name	Settings	Description	Reset	Access
0x486	ECNT_CTRL6	[7:6]	RESERVED		Reserved.	0x0	R
		[5:3]	ECNT_ENA6		Error counter enables for Lane 6. This control is paged by the LINK_PAGE control in Register 0x300. Counters of each lane are addressed as follows: Bit 5 = unexpected K character error (UEK). Bit 4 = not in table error (NIT). Bit 3 = bad disparity error (BDE).	0x7	R/W
		[2:0]	ECNT_RST6		Reset error counters for Lane 6. This control is paged by the LINK_PAGE control in Register 0x300. Counters of each lane are addressed as follows: Bit 2 = unexpected K character error (UEK). Bit 1 = not in table error (NIT). Bit 0 = bad disparity error (BDE).	0x7	R/W
0x487	ECNT_CTRL7	[7:6]	RESERVED		Reserved.	0x0	R
		[5:3]	ECNT_ENA7		Error counter enables for Lane 7. This control is paged by the LINK_PAGE control in Register 0x300. Counters of each lane are addressed as follows: Bit 5 = unexpected K character error (UEK). Bit 4 = not in table error (NIT). Bit 3 = bad disparity error (BDE).	0x7	R/W
		[2:0]	ECNT_RST7		Reset error counters for Lane 7. This control is paged by the LINK_PAGE control in Register 0x300. Counters of each lane are addressed as follows: Bit 2 = unexpected K character error (UEK). Bit 1 = not in table error (NIT). Bit 0 = bad disparity error (BDE).	0x7	R/W
0x488	ECNT_TCH0	[7:3]	RESERVED		Reserved.	0x0	R
		[2:0]	ECNT_TCH0		Terminal count hold enable of error counters for Lane 0. This control is paged by the LINK_PAGE control in Register 0x300. When set, the designated counter is to hold the terminal count value of 0xFF when it is reached until the counter is reset by the user. Otherwise, the designated counter rolls over. Counters of each lane are addressed as follows: Bit 2 = unexpected K character error (UEK). Bit 1 = not in table error (NIT). Bit 0 = bad disparity error (BDE).  This signal must only be programmed while the QBD is held in soft reset (Register 0x475, Bit 3), and must not be changed during normal operation.	0x7	R/W
0x489	ECNT_TCH1	[7:3]	RESERVED		Reserved.	0x0	R
		[2:0]	ECNT_TCH1		Terminal count hold enable of error counters for Lane 1. This control is paged by the LINK_PAGE control in Register 0x300. When set, the designated counter is to hold the terminal count value of 0xFF when it is reached until the counter is reset by the user. Otherwise, the designated counter rolls over. Counters of each lane are addressed as follows: Bit 2 = unexpected K character error (UEK). Bit 1 = not in table error (NIT). Bit 0 = bad disparity error (BDE).	0x7	R/W

## REGISTER DETAILS

Table 60. Register Details

Addr.	Name	Bits	Bit Name	Settings	Description	Reset	Access
0x48A	ECNT_TCH2	[7:3]	RESERVED		This signal must only be programmed while the QBD is held in soft reset (Register 0x475, Bit 3), and must not be changed during normal operation.		
		[2:0]	ECNT_TCH2		Reserved. Terminal count hold enable of error counters for Lane 2. This control is paged by the LINK_PAGE control in Register 0x300. When set, the designated counter is to hold the terminal count value of 0xFF when it is reached until the counter is reset by the user. Otherwise, the designated counter rolls over. Counters of each lane are addressed as follows: Bit 2 = unexpected K character error (UEK). Bit 1 = not in table error (NIT). Bit 0 = bad disparity error (BDE). This signal must only be programmed while the QBD is held in soft reset (Register 0x475, Bit 3), and must not be changed during normal operation.	0x0	R
0x48B	ECNT_TCH3	[7:3]	RESERVED		Reserved.	0x0	R
		[2:0]	ECNT_TCH3		Terminal count hold enable of error counters for Lane 3. This control is paged by the LINK_PAGE control in Register 0x300. When set, the designated counter is to hold the terminal count value of 0xFF when it is reached until the counter is reset by the user. Otherwise, the designated counter rolls over. Counters of each lane are addressed as follows: Bit 2 = unexpected K character error (UEK). Bit 1 = not in table error (NIT). Bit 0 = bad disparity error (BDE). This signal must only be programmed while the QBD is held in soft reset (Register 0x475, Bit 3), and must not be changed during normal operation.	0x7	R/W
0x48C	ECNT_TCH4	[7:3]	RESERVED		Reserved.	0x0	R
		[2:0]	ECNT_TCH4		Terminal count hold enable of error counters for Lane 4. This control is paged by the LINK_PAGE control in Register 0x300. When set, the designated counter is to hold the terminal count value of 0xFF when it is reached until the counter is reset by the user. Otherwise, the designated counter rolls over. Counters of each lane are addressed as follows: Bit 2 = unexpected K character error (UEK). Bit 1 = not in table error (NIT). Bit 0 = bad disparity error (BDE). This signal must only be programmed while the QBD is held in soft reset (Register 0x475, Bit 3), and must not be changed during normal operation.	0x7	R/W
0x48D	ECNT_TCH5	[7:3]	RESERVED		Reserved.	0x0	R
		[2:0]	ECNT_TCH5		Terminal count hold enable of error counters for Lane 5. This control is paged by the LINK_PAGE control in Register 0x300. When set, the designated counter is to hold the terminal count value of 0xFF when it is reached until the counter is reset by the user. Otherwise, the designated counter rolls over. Counters of each lane are addressed as follows:	0x7	R/W

## REGISTER DETAILS

Table 60. Register Details

Addr.	Name	Bits	Bit Name	Settings	Description	Reset	Access
					Bit 2 = unexpected K character error (UEK). Bit 1 = not in table error (NIT). Bit 0 = bad disparity error (BDE). This signal must only be programmed while the QBD is held in soft reset (Register 0x475, Bit 3), and must not be changed during normal operation.		
0x48E	ECNT_TCH6	[7:3]	RESERVED		Reserved.	0x0	R
		[2:0]	ECNT_TCH6		Terminal count hold enable of error counters for Lane 6. This control is paged by the LINK_PAGE control in Register 0x300. When set, the designated counter is to hold the terminal count value of 0xFF when it is reached until the counter is reset by the user. Otherwise, the designated counter rolls over. Counters of each lane are addressed as follows: Bit 2 = unexpected K character error (UEK). Bit 1 = not in table error (NIT). Bit 0 = bad disparity error (BDE). This signal must only be programmed while the QBD is held in soft reset (Register 0x475, Bit 3), and must not be changed during normal operation.	0x7	R/W
0x48F	ECNT_TCH7	[7:3]	RESERVED		Reserved.	0x0	R
		[2:0]	ECNT_TCH7		Terminal count hold enable of error counters for Lane 7. This control is paged by the LINK_PAGE control in Register 0x300. When set, the designated counter is to hold the terminal count value of 0xFF when it is reached until the counter is reset by the user. Otherwise, the designated counter rolls over. Counters of each lane are addressed as follows: Bit 2 = unexpected K character error (UEK). Bit 1 = not in table error (NIT). Bit 0 = bad disparity error (BDE). This signal must only be programmed while the QBD is held in soft reset (Register 0x475, Bit 3), and must not be changed during normal operation.	0x7	R/W
0x490	ECNT_STAT0	[7:4]	RESERVED		Reserved.	0x0	R
		3	LANE_ENA0		This output indicates if Lane 0 is enabled. This control is paged by the LINK_PAGE control in Register 0x300.	0x0	R
		[2:0]	ECNT_TCR0		Terminal count reached indicator of error counters for Lane 0. This control is paged by the LINK_PAGE control in Register 0x300. Set these bits to 1 when the corresponding counter terminal count value of 0xFF is reached. If ECNT_TCHx is set, the terminal count value for the corresponding counter is held until the counter is reset by the user; otherwise, the counter rolls over and continues counting. Counters of each lane are addressed as follows: Bit 2 = unexpected K character error (UEK). Bit 1 = not in table error (NIT). Bit 0 = bad disparity error (BDE).	0x0	R
0x491	ECNT_STAT1	[7:4]	RESERVED		Reserved.	0x0	R

## REGISTER DETAILS

Table 60. Register Details

Addr.	Name	Bits	Bit Name	Settings	Description	Reset	Access
		3	LANE_ENA1		This output indicates if Lane 1 is enabled. This control is paged by the LINK_PAGE control in Register 0x300.	0x0	R
		[2:0]	ECNT_TCR1		Terminal count reached indicator of error counters for Lane 1. This control is paged by the LINK_PAGE control in Register 0x300. Set these bits to 1 when the corresponding counter terminal count value of 0xFF is reached. If ECNT_TCHx is set, the terminal count value for the corresponding counter is held until the counter is reset by the user; otherwise, the counter rolls over and continues counting. Counters of each lane are addressed as follows: Bit 2 = unexpected K character error (UEK). Bit 1 = not in table error (NIT). Bit 0 = bad disparity error (BDE).	0x0	R
0x492	ECNT_STAT2	[7:4]	RESERVED		Reserved.	0x0	R
		3	LANE_ENA2		This output indicates if Lane 2 is enabled. This control is paged by the LINK_PAGE control in Register 0x300.	0x0	R
		[2:0]	ECNT_TCR2		Terminal count reached indicator of error counters for Lane 2. This control is paged by the LINK_PAGE control in Register 0x300. Set these bits to 1 when the corresponding counter terminal count value of 0xFF is reached. If ECNT_TCHx is set, the terminal count value for the corresponding counter is held until the counter is reset by the user; otherwise, the counter rolls over and continues counting. Counters of each lane are addressed as follows: Bit 2 = unexpected K character error (UEK). Bit 1 = not in table error (NIT). Bit 0 = bad disparity error (BDE).	0x0	R
0x493	ECNT_STAT3	[7:4]	RESERVED		Reserved.	0x0	R
		3	LANE_ENA3		This output indicates if Lane 3 is enabled. This control is paged by the LINK_PAGE control in Register 0x300.	0x0	R
		[2:0]	ECNT_TCR3		Terminal count reached indicator of error counters for Lane 3. This control is paged by the LINK_PAGE control in Register 0x300. Set these bits to 1 when the corresponding counter terminal count value of 0xFF is reached. If ECNT_TCHx is set, the terminal count value for the corresponding counter is held until the counter is reset by the user; otherwise, the counter rolls over and continues counting. Counters of each lane are addressed as follows: Bit 2 = unexpected K character error (UEK). Bit 1 = not in table error (NIT). Bit 0 = bad disparity error (BDE).	0x0	R
0x494	ECNT_STAT4	[7:4]	RESERVED		Reserved.	0x0	R
		3	LANE_ENA4		This output indicates if Lane 4 is enabled. This control is paged by the LINK_PAGE control in Register 0x300.	0x0	R
		[2:0]	ECNT_TCR4		Terminal count reached indicator of error counters for Lane 4. This control is paged by the LINK_PAGE control in Register 0x300. Set these bits to 1 when	0x0	R

## REGISTER DETAILS

Table 60. Register Details

Addr.	Name	Bits	Bit Name	Settings	Description	Reset	Access
					the corresponding counter terminal count value of 0xFF is reached. If ECNT_TCHx is set, the terminal count value for the corresponding counter is held until the counter is reset by the user; otherwise, the counter rolls over and continues counting. Counters of each lane are addressed as follows: Bit 2 = unexpected K character error (UEK). Bit 1 = not in table error (NIT). Bit 0 = bad disparity error (BDE).		
0x495	ECNT_STAT5	[7:4]	RESERVED		Reserved.	0x0	R
		3	LANE_ENA5		This output indicates if Lane 5 is enabled. This control is paged by the LINK_PAGE control in Register 0x300.	0x0	R
		[2:0]	ECNT_TCR5		Terminal count reached indicator of error counters for Lane 5. This control is paged by the LINK_PAGE control in Register 0x300. Set these bits to 1 when the corresponding counter terminal count value of 0xFF is reached. If ECNT_TCHx is set, the terminal count value for the corresponding counter is held until the counter is reset by the user; otherwise, the counter rolls over and continues counting. Counters of each lane are addressed as follows: Bit 2 = unexpected K character error (UEK). Bit 1 = not in table error (NIT). Bit 0 = bad disparity error (BDE).	0x0	R
0x496	ECNT_STAT6	[7:4]	RESERVED		Reserved.	0x0	R
		3	LANE_ENA6		This output indicates if Lane 6 is enabled. This control is paged by the LINK_PAGE control in Register 0x300.	0x0	R
		[2:0]	ECNT_TCR6		Terminal count reached indicator of error counters for Lane 6. This control is paged by the LINK_PAGE control in Register 0x300. Set these bits to 1 when the corresponding counter terminal count value of 0xFF is reached. If ECNT_TCHx is set, the terminal count value for the corresponding counter is held until the counter is reset by the user; otherwise, the counter rolls over and continues counting. Counters of each lane are addressed as follows: Bit 2 = unexpected K character error (UEK). Bit 1 = not in table error (NIT). Bit 0 = bad disparity error (BDE).	0x0	R
0x497	ECNT_STAT7	[7:4]	RESERVED		Reserved.	0x0	R
		3	LANE_ENA7		This output indicates if Lane 7 is enabled. This control is paged by the LINK_PAGE control in Register 0x300.	0x0	R
		[2:0]	ECNT_TCR7		Terminal count reached indicator of error counters for Lane 7. This control is paged by the LINK_PAGE control in Register 0x300. Set these bits to 1 when the corresponding counter terminal count value of 0xFF is reached. If ECNT_TCHx is set, the terminal count value for the corresponding counter is held until the counter is reset by the user; otherwise, the counter rolls over and continues counting. Counters of each lane are addressed as follows:	0x0	R



## REGISTER DETAILS

Table 60. Register Details

Addr.	Name	Bits	Bit Name	Settings	Description	Reset	Access		
0x4B0	LINK_STATUS0	7	BDE0		Bit 2 = unexpected K character error (UEK). Bit 1 = not in table error (NIT). Bit 0 = bad disparity error (BDE).	0x0	R		
				0	Bad disparity errors status for Lane 0. This control is paged by the LINK_PAGE control in Register 0x300. Error count < ETH[7:0] value.				
				1	Error count ≥ ETH[7:0] value.				
				6	NIT0				Not in table errors status for Lane 0. This control is paged by the LINK_PAGE control in Register 0x300.
								0	Error count < ETH[7:0] value.
								1	Error count ≥ ETH[7:0] value.
				5	UEK0				Unexpected K character errors status for Lane 0. This control is paged by the LINK_PAGE control in Register 0x300.
								0	Error count < ETH[7:0] value.
				1	Error count ≥ ETH[7:0] value.				
4	ILD0		Interlane deskew status for Lane 0. This control is paged by the LINK_PAGE control in Register 0x300.						
		0	Deskew failed.						
1	Deskew achieved.								
3	ILS0		Initial lane synchronization status for Lane 0. This control is paged by the LINK_PAGE control in Register 0x300.						
		0	Synchronization lost.						
1	Synchronization achieved.								
2	CKS0		Computed checksum status for Lane 0. This control is paged by the LINK_PAGE control in Register 0x300.						
		0	Checksum is incorrect.						
1	Checksum is correct.								
1	FS0		Frame synchronization status for Lane 0. This control is paged by the LINK_PAGE control in Register 0x300.						
		0	Synchronization lost.						
		1	Synchronization achieved.						
0	CGS0		Code group synchronization status for Lane 0. This control is paged by the LINK_PAGE control in Register 0x300.						
		0	Synchronization lost.						
		1	Synchronization achieved.						
0x4B1	LINK_STATUS1	7	BDE1		Bad disparity errors status for Lane 1. This control is paged by the LINK_PAGE control in Register 0x300.	0x0	R		
				0	Error count < ETH[7:0] value.				
				1	Error count ≥ ETH[7:0] value.				
6	NIT1		Not in table errors status for Lane 1. This control is paged by the LINK_PAGE control in Register 0x300.						
		0	Error count < ETH[7:0] value.						
1	Error count ≥ ETH[7:0] value.								
5	UEK1		Unexpected K character errors status for Lane 1. This control is paged by the LINK_PAGE control in Register 0x300.						
		0	Error count < ETH[7:0] value.						

## REGISTER DETAILS

Table 60. Register Details

Addr.	Name	Bits	Bit Name	Settings	Description	Reset	Access		
0x4B2	LINK_STATUS2	4	ILD1	1	Error count $\geq$ ETH[7:0] value.	0x0	R		
				0	Deskew failed.				
		3	ILS1	1	Deskew achieved.				
				0	Initial lane synchronization status for Lane 1. This control is paged by the LINK_PAGE control in Register 0x300.				
		2	CKS1	1	Synchronization lost.	0x0	R		
				0	Synchronization achieved.				
		1	FS1	1	Computed checksum status for Lane 1. This control is paged by the LINK_PAGE control in Register 0x300.	0x0	R		
				0	Checksum is incorrect.				
		0	CGS1	1	Checksum is correct.	0x0	R		
				0	Frame synchronization status for Lane 1. This control is paged by the LINK_PAGE control in Register 0x300.				
		0x4B2	LINK_STATUS2	7	BDE2	1	Code group synchronization status for Lane 1. This control is paged by the LINK_PAGE control in Register 0x300.	0x0	R
						0	Synchronization lost.		
6	NIT2			1	Synchronization achieved.	0x0	R		
				0	Bad disparity errors status for Lane 2. This control is paged by the LINK_PAGE control in Register 0x300.				
5	UEK2			1	Error count $<$ ETH[7:0] value.	0x0	R		
				0	Error count $\geq$ ETH[7:0] value.				
4	ILD2			1	Not in table errors status for Lane 2. This control is paged by the LINK_PAGE control in Register 0x300.	0x0	R		
				0	Error count $<$ ETH[7:0] value.				
3	ILS2			1	Error count $\geq$ ETH[7:0] value.	0x0	R		
				0	Unexpected K character errors status for Lane 2. This control is paged by the LINK_PAGE control in Register 0x300.				
2	CKS2			1	Interlane deskew status for Lane 2. This control is paged by the LINK_PAGE control in Register 0x300.	0x0	R		
				0	Deskew failed.				
2	CKS2	1	Deskew achieved.	0x0	R				
		0	Initial lane synchronization status for Lane 2. This control is paged by the LINK_PAGE control in Register 0x300.						
2	CKS2	1	Synchronization lost.	0x0	R				
		0	Synchronization achieved.						
2	CKS2	1	Computed checksum status for Lane 2. This control is paged by the LINK_PAGE control in Register 0x300.	0x0	R				
		0	Checksum is incorrect.						
2	CKS2	1	Checksum is correct.	0x0	R				
		0	Checksum is correct.						

## REGISTER DETAILS

Table 60. Register Details

Addr.	Name	Bits	Bit Name	Settings	Description	Reset	Access
		1	FS2	0	Frame synchronization status for Lane 2. This control is paged by the LINK_PAGE control in Register 0x300. Synchronization lost.	0x0	R
				1	Synchronization achieved.		
		0	CGS2	0	Code group synchronization status for Lane 2. This control is paged by the LINK_PAGE control in Register 0x300. Synchronization lost.	0x0	R
				1	Synchronization achieved.		
0x4B3	LINK_STATUS3	7	BDE3	0	Bad disparity errors status for Lane 3. This control is paged by the LINK_PAGE control in Register 0x300. Error count < ETH[7:0] value.	0x0	R
				1	Error count ≥ ETH[7:0] value.		
		6	NIT3	0	Not in table errors status for Lane 3. This control is paged by the LINK_PAGE control in Register 0x300. Error count < ETH[7:0] value.	0x0	R
				1	Error count ≥ ETH[7:0] value.		
		5	UEK3	0	Unexpected K character errors status for Lane 3. This control is paged by the LINK_PAGE control in Register 0x300. Error count < ETH[7:0] value.	0x0	R
				1	Error count ≥ ETH[7:0] value.		
		4	ILD3	0	Interlane deskew status for Lane 3. This control is paged by the LINK_PAGE control in Register 0x300. Deskew failed.	0x0	R
				1	Deskew achieved.		
		3	ILS3	0	Initial lane synchronization status for Lane 3. This control is paged by the LINK_PAGE control in Register 0x300. Synchronization lost.	0x0	R
				1	Synchronization achieved.		
2	CKS3	0	Computed checksum status for Lane 3. This control is paged by the LINK_PAGE control in Register 0x300. Checksum is incorrect.	0x0	R		
		1	Checksum is correct.				
1	FS3	0	Frame synchronization status for Lane 3. This control is paged by the LINK_PAGE control in Register 0x300. Synchronization lost.	0x0	R		
		1	Synchronization achieved.				
0	CGS3	0	Code group synchronization status for Lane 3. This control is paged by the LINK_PAGE control in Register 0x300. Synchronization lost.	0x0	R		
		1	Synchronization achieved.				
0x4B4	LINK_STATUS4	7	BDE4	0	Bad disparity errors status for Lane 4. This control is paged by the LINK_PAGE control in Register 0x300. Error count < ETH[7:0] value.	0x0	R
				1	Error count ≥ ETH[7:0] value.		

## REGISTER DETAILS

Table 60. Register Details

Addr.	Name	Bits	Bit Name	Settings	Description	Reset	Access
		6	NIT4	0	Not in table errors status for Lane 4. This control is paged by the LINK_PAGE control in Register 0x300. Error count < ETH[7:0] value.	0x0	R
				1	Error count ≥ ETH[7:0] value.		
		5	UEK4	0	Unexpected K character errors status for Lane 4. This control is paged by the LINK_PAGE control in Register 0x300. Error count < ETH[7:0] value.	0x0	R
				1	Error count ≥ ETH[7:0] value.		
		4	ILD4	0	Interlane deskew status for Lane 4. This control is paged by the LINK_PAGE control in Register 0x300. Deskew failed.	0x0	R
				1	Deskew achieved.		
		3	ILS4	0	Initial lane synchronization status for Lane 4. This control is paged by the LINK_PAGE control in Register 0x300. Synchronization lost.	0x0	R
				1	Synchronization achieved.		
2	CKS4	0	Computed checksum status for Lane 4. This control is paged by the LINK_PAGE control in Register 0x300. Checksum is incorrect.	0x0	R		
		1	Checksum is correct.				
1	FS4	0	Frame synchronization status for Lane 4. This control is paged by the LINK_PAGE control in Register 0x300. Synchronization lost.	0x0	R		
		1	Synchronization achieved.				
0	CGS4	0	Code group synchronization status for Lane 4. This control is paged by the LINK_PAGE control in Register 0x300. Synchronization lost.	0x0	R		
		1	Synchronization achieved.				
0x4B5	LINK_STATUS5	7	BDE5	0	Bad disparity errors status for Lane 5. This control is paged by the LINK_PAGE control in Register 0x300. Error count < ETH[7:0] value.	0x0	R
				1	Error count ≥ ETH[7:0] value.		
		6	NIT5	0	Not in table errors status for Lane 5. This control is paged by the LINK_PAGE control in Register 0x300. Error count < ETH[7:0] value.	0x0	R
				1	Error count ≥ ETH[7:0] value.		
5	UEK5	0	Unexpected K character errors status for Lane 5. This control is paged by the LINK_PAGE control in Register 0x300. Error count < ETH[7:0] value.	0x0	R		
		1	Error count ≥ ETH[7:0] value.				
4	ILD5	0	Interlane deskew status for Lane 5. This control is paged by the LINK_PAGE control in Register 0x300. Deskew failed.	0x0	R		
		1	Deskew achieved.				

## REGISTER DETAILS

Table 60. Register Details

Addr.	Name	Bits	Bit Name	Settings	Description	Reset	Access
		3	ILS5	0	Initial lane synchronization status for Lane 5. This control is paged by the LINK_PAGE control in Register 0x300. Synchronization lost.	0x0	R
				1	Synchronization achieved.		
		2	CKS5	0	Computed checksum status for Lane 5. This control is paged by the LINK_PAGE control in Register 0x300. Checksum is incorrect.	0x0	R
				1	Checksum is correct.		
		1	FS5	0	Frame synchronization status for Lane 5. This control is paged by the LINK_PAGE control in Register 0x300. Synchronization lost.	0x0	R
				1	Synchronization achieved.		
		0	CGS5	0	Code group synchronization status for Lane 5. This control is paged by the LINK_PAGE control in Register 0x300. Synchronization lost.	0x0	R
				1	Synchronization achieved.		
0x4B6	LINK_STATUS6	7	BDE6	0	Bad disparity errors status for Lane 6. This control is paged by the LINK_PAGE control in Register 0x300. Error count < ETH[7:0] value.	0x0	R
				1	Error count ≥ ETH[7:0] value.		
		6	NIT6	0	Not in table errors status for Lane 6. This control is paged by the LINK_PAGE control in Register 0x300. Error count < ETH[7:0] value.	0x0	R
				1	Error count ≥ ETH[7:0] value.		
		5	UEK6	0	Unexpected K character errors status for Lane 6. This control is paged by the LINK_PAGE control in Register 0x300. Error count < ETH[7:0] value.	0x0	R
				1	Error count ≥ ETH[7:0] value.		
		4	ILD6	0	Interlane deskew status for Lane 6. This control is paged by the LINK_PAGE control in Register 0x300. Deskew failed.	0x0	R
				1	Deskew achieved.		
3	ILS6	0	Initial lane synchronization status for Lane 6. This control is paged by the LINK_PAGE control in Register 0x300. Synchronization lost.	0x0	R		
		1	Synchronization achieved.				
2	CKS6	0	Computed checksum status for Lane 6. This control is paged by the LINK_PAGE control in Register 0x300. Checksum is incorrect.	0x0	R		
		1	Checksum is correct.				
1	FS6	0	Frame synchronization status for Lane 6. This control is paged by the LINK_PAGE control in Register 0x300. Synchronization lost.	0x0	R		
		1	Synchronization achieved.				

## REGISTER DETAILS

Table 60. Register Details

Addr.	Name	Bits	Bit Name	Settings	Description	Reset	Access
0x4B7	LINK_STATUS7	0	CGS6		Code group synchronization status for Lane 6. This control is paged by the LINK_PAGE control in Register 0x300.	0x0	R
				0	Synchronization lost.		
				1	Synchronization achieved.		
		7	BDE7		Bad disparity errors status for Lane 7. This control is paged by the LINK_PAGE control in Register 0x300.	0x0	R
				0	Error count < ETH[7:0] value.		
				1	Error count ≥ ETH[7:0] value.		
		6	NIT7		Not in table errors status for Lane 7. This control is paged by the LINK_PAGE control in Register 0x300.	0x0	R
				0	Error count < ETH[7:0] value.		
				1	Error count ≥ ETH[7:0] value.		
5	UEK7		Unexpected K character errors status Lane 7. This control is paged by the LINK_PAGE control in Register 0x300.	0x0	R		
		0	Error count < ETH[7:0] value.				
		1	Error count ≥ ETH[7:0] value.				
4	ILD7		Interlane deskew status for Lane 7. This control is paged by the LINK_PAGE control in Register 0x300.	0x0	R		
		0	Deskew failed.				
		1	Deskew achieved.				
3	ILS7		Initial lane synchronization status for Lane 7. This control is paged by the LINK_PAGE control in Register 0x300.	0x0	R		
		0	Synchronization lost.				
		1	Synchronization achieved.				
2	CKS7		Computed checksum status for Lane 7. This control is paged by the LINK_PAGE control in Register 0x300.	0x0	R		
		0	Checksum is incorrect.				
		1	Checksum is correct.				
1	FS7		Frame synchronization status for Lane 7. This control is paged by the LINK_PAGE control in Register 0x300.	0x0	R		
		0	Synchronization lost.				
		1	Synchronization achieved.				
0	CGS7		Code group synchronization status for Lane 7. This control is paged by the LINK_PAGE control in Register 0x300.	0x0	R		
		0	Synchronization lost.				
		1	Synchronization achieved.				
0x4B8	JESD_IRQ_ENABLEA	7	EN_BDE		Bad disparity error counter. This control is paged by the LINK_PAGE control in Register 0x300.	0x0	R/W
		6	EN_NIT		Not in table error counter. This control is paged by the LINK_PAGE control in Register 0x300.	0x0	R/W
		5	EN_UEK		Unexpected K error counter. This control is paged by the LINK_PAGE control in Register 0x300.	0x0	R/W
		4	EN_ILD		Interlane deskew. This control is paged by the LINK_PAGE control in Register 0x300.	0x0	R/W
		3	EN_ILS		Initial lane synchronization. This control is paged by the LINK_PAGE control in Register 0x300.	0x0	R/W

## REGISTER DETAILS

Table 60. Register Details

Addr.	Name	Bits	Bit Name	Settings	Description	Reset	Access
		2	EN_CKS		Good checksum. This bit compares two checksums: the checksum that the transmitter sent over the link during the ILAS and the checksum that the receiver calculated from the ILAS data that the transmitter sent over the link. Note that the checksum IRQ only looks at data sent by the transmitter and not the checksum programmed into Register 0x45D. This control is paged by the LINK_PAGE control in Register 0x300.	0x0	R/W
		1	EN_FS		Frame synchronization. This control is paged by the LINK_PAGE control in Register 0x300.	0x0	R/W
		0	EN_CGS		Code group synchronization. This control is paged by the LINK_PAGE control in Register 0x300.	0x0	R/W
0x4B9	JESD_IRQ_ENABLEB	[7:1]	RESERVED		Reserved.	0x0	R
		0	EN_ILAS		Configuration mismatch (checked for Lane 0 only). The ILAS IRQ compares the two sets of ILAS data obtained by the receiver. The first set of data is the ILAS data sent over the JESD204B link by the transmitter. The second set of data is the ILAS data programmed into the receiver via the SPI (Register 0x450 to Register 0x45D). If any of the data differs, the IRQ is triggered. Note that all of the ILAS data, including the checksum, is compared. This control is paged by the LINK_PAGE control in Register 0x300.	0x0	R/W
0x4BA	JESD_IRQ_STATUSA	7	IRQ_BDE		Bad disparity error counter. This control is paged by the LINK_PAGE control in Register 0x300.	0x0	R/W
		6	IRQ_NIT		Not in table error counter. This control is paged by the LINK_PAGE control in Register 0x300.	0x0	R/W
		5	IRQ_UEK		Unexpected K error counter. This control is paged by the LINK_PAGE control in Register 0x300.	0x0	R/W
		4	IRQ_ILD		Interlane deskew. This control is paged by the LINK_PAGE control in Register 0x300.	0x0	R/W
		3	IRQ_ILS		Initial lane synchronization. This control is paged by the LINK_PAGE control in Register 0x300.	0x0	R/W
		2	IRQ_CKS		Good checksum. This control is paged by the LINK_PAGE control in Register 0x300.	0x0	R/W
		1	IRQ_FS		Frame synchronization. This control is paged by the LINK_PAGE control in Register 0x300.	0x0	R/W
		0	IRQ_CGS		Code group synchronization. This control is paged by the LINK_PAGE control in Register 0x300.	0x0	R/W
0x4BB	JESD_IRQ_STATUSB	[7:1]	RESERVED		Reserved.	0x0	R
		0	IRQ_ILAS		Configuration mismatch (checked for Lane 0 only). This control is paged by the LINK_PAGE control in Register 0x300.	0x0	R/W
0x4BC	IRQ_OUTPUT_MUX_JESD	[7:1]	RESERVED		Reserved.	0x0	R
		0	MUX_JESD_IRQ	0 1	Selects which IRQ pin is connected to the JESD204B sources. Route the IRQ trigger signal to the pin. Route the IRQ trigger signal to the pin.	0x0	R/W
0x580	BE_SOFT_OFF_GAIN_CTRL	7	BE_SOFT_OFF_GAIN_EN		Must be 1 to use soft off/on. This control is paged by the MAINDAC_PAGE control in Register 0x008.	0x0	R/W
		[6:3]	RESERVED		Reserved.	0x0	R

## REGISTER DETAILS

Table 60. Register Details

Addr.	Name	Bits	Bit Name	Settings	Description	Reset	Access
		[2:0]	BE_GAIN_RAMP_RATE		Sets ramp rate. The gain ramps from 0 to 1 (or 1 to 0) in 32 steps over $2^{(\text{CODE} + 8)}$ DAC clock periods. This control is paged by the MAINDAC_PAGE control in Register 0x008.	0x0	R/W
0x581	BE_SOFT_OFF_ENABLE	7	ENA_SHORT_PAERR_SOFTOFF		Enable short PA error soft off. This control is paged by the MAINDAC_PAGE control in Register 0x008.	0x1	R/W
		6	ENA_LONG_PAERR_SOFTOFF		Enable long PA error soft off. This control is paged by the MAINDAC_PAGE control in Register 0x008.	0x1	R/W
		[5:4]	RESERVED		Reserved.	0x0	R
		3	ENA_JESD_ERR_SOFTOFF		Enable JESD204B side error soft off. This control is paged by the MAINDAC_PAGE control in Register 0x008.	0x0	R/W
		2	ROTATE_SOFT_OFF_EN		When set to 1, the synchronization logic rotation triggers the DAC output soft off. Note that Register 0x03B, Bit 0 must also be high. This control is paged by the MAINDAC_PAGE control in Register 0x008.	0x1	R/W
		1	TXEN_SOFT_OFF_EN		When set to 1, a TXENx falling edge triggers the DAC output soft off. This control is paged by the MAINDAC_PAGE control in Register 0x008.	0x1	R/W
		0	SPI_SOFT_OFF_EN		Force a soft off when gain is 1. This control is paged by the MAINDAC_PAGE control in Register 0x008.	0x0	R/W
0x582	BE_SOFT_ON_ENABLE	7	SPI_SOFT_ON_EN		Force a soft on when gain is 0. This control is paged by the MAINDAC_PAGE control in Register 0x008.	0x0	R/W
		6	LONG_LEVEL_SOFTON_EN		When set to 1, this bit enables the long level soft on. This control is paged by the MAINDAC_PAGE control in Register 0x008.	0x1	R/W
		[5:0]	RESERVED		Reserved.	0x0	R/W
0x583	LONG_PA_THRES_LSB	[7:0]	LONG_PA_THRESHOLD[7:0]		Long average power threshold for comparison. This control is paged by the MAINDAC_PAGE control in Register 0x008.	0x0	R/W
0x584	LONG_PA_THRES_MSB	[7:5]	RESERVED		Reserved.	0x0	R
		[4:0]	LONG_PA_THRESHOLD[12:8]		Long average power threshold for comparison. This control is paged by the MAINDAC_PAGE control in Register 0x008.	0x0	R/W
0x585	LONG_PA_CONTROL	7	LONG_PA_ENABLE		Enable long average power calculation and error detection. This control is paged by the MAINDAC_PAGE control in Register 0x008.	0x0	R/W
		[6:4]	RESERVED		Reserved.	0x0	R
		[3:0]	LONG_PA_AVG_TIME		Sets length of long PA averaging time. This control is paged by the MAINDAC_PAGE control in Register 0x008. Averaging time = $29 + \text{LONG\_PA\_AVG\_TIME}$ (PA clock periods). A PA clock period is calculated by the following: If the main interpolation is $>1\times$ , PA clock period = $4 \times \text{main interpolation} \times \text{DAC clock period}$ . If channel interpolation is $>1\times$ , PA clock period = $8 \times \text{main interpolation} \times \text{DAC clock period}$ . Otherwise, PA clock period = $32 \times \text{DAC clock period}$ .	0x0	R/W
0x586	LONG_PA_POWER_LSB	[7:0]	LONG_PA_POWER[7:0]		Long average power readback. Power detected at data bus = $I2 + Q2$ . The data bus calculation only uses the 6 MSBs of the I and Q data bus samples. This control is paged by the MAINDAC_PAGE control in Register 0x008.	0x0	R



## REGISTER DETAILS

Table 60. Register Details

Addr.	Name	Bits	Bit Name	Settings	Description	Reset	Access
0x587	LONG_PA_POWER_MSB	[7:5]	RESERVED		Reserved.	0x0	R
		[4:0]	LONG_PA_POWER[12:8]		Long average power readback. Power detected at data bus = I2 + Q2. The data bus calculation only uses the 6 MSBs of the I and Q data bus samples. This control is paged by the MAINDAC_PAGE control in Register 0x008.	0x0	R
0x588	SHORT_PA_THRES_LSB	[7:0]	SHORT_PA_THRESHOLD[7:0]		Short average power threshold for comparison. This control is paged by the MAINDAC_PAGE control in Register 0x008.	0x0	R/W
0x589	SHORT_PA_THRES_MSB	[7:5]	RESERVED		Reserved.	0x0	R
		[4:0]	SHORT_PA_THRESHOLD[12:8]		Short average power threshold for comparison. This control is paged by the MAINDAC_PAGE control in Register 0x008.	0x0	R/W
0x58A	SHORT_PA_CONTROL	7	SHORT_PA_ENABLE		Enable short average power calculation and error detection. This control is paged by the MAINDAC_PAGE control in Register 0x008.	0x0	R/W
		[6:2]	RESERVED		Reserved.	0x0	R
		[1:0]	SHORT_PA_AVG_TIME		Sets length of short PA averaging. This control is paged by the MAINDAC_PAGE control in Register 0x008. Averaging time = $2^{\text{SHORT\_PA\_AVG\_TIME}}$ (PA clock periods). A PA clock period is calculated by the following: If the main interpolation is $>1\times$ , PA clock period = $4 \times$ main interpolation $\times$ DAC clock period. If channel interpolation is $>1\times$ , PA clock period = $8 \times$ main interpolation $\times$ DAC clock period. Otherwise, PA clock period = $32 \times$ DAC clock period.	0x0	R/W
0x58B	SHORT_PA_POWER_LSB	[7:0]	SHORT_PA_POWER[7:0]		Short average power readback. Power detected at data bus = I2 + Q2. The data bus calculation only uses the 6 MSBs of the I and Q data bus samples. This control is paged by the MAINDAC_PAGE control in Register 0x008.	0x0	R
0x58C	SHORT_PA_POWER_MSB	[7:5]	RESERVED		Reserved.	0x0	R
		[4:0]	SHORT_PA_POWER[12:8]		Short average power readback. Power detected at data bus = I2 + Q2. The data bus calculation only uses the 6 MSBs of the I and Q data bus samples. This control is paged by the MAINDAC_PAGE control in Register 0x008.	0x0	R
0x58D	TXEN_SM_0	[7:1]	RESERVED		Reserved.	0x1	R/W
		0	ENA_TXENSM		Enable TXEN state machine. This control is paged by the MAINDAC_PAGE control in Register 0x008.	0x0	R/W
0x596	BLANKING_CTRL	[7:4]	RESERVED		Reserved.	0x0	R
		3	SPI_TXEN		If ENA_SPI_TXEN (Bit 2 of this register) = 1, the value of this register is the value of the TXENx status. This control is paged by the MAINDAC_PAGE control in Register 0x008.	0x0	R/W
		2	ENA_SPI_TXEN		Enable TXENx control via the SPI by setting this bit to 1. This control is paged by the MAINDAC_PAGE control in Register 0x008.	0x0	R/W
		[1:0]	RESERVED		Reserved.	0x0	R
0x597	JESD_PA_INT0	[7:0]	JESD_PA_INT_		Each bit enables a JESD204B PA interrupt.	0x0	R/W

## REGISTER DETAILS

Table 60. Register Details

Addr.	Name	Bits	Bit Name	Settings	Description	Reset	Access
			CNTRL[7:0]		Bit 8 = CGS. Bit 7 = frame sync. Bit 6 = good check sum. Bit 5 = initial lane sync. Bit 4 = interlane deskew. Bit 3 = bad disparity error counter. Bit 2 = NIT error counter. Bit 1 = UEK error counter. Bit 0 = lane FIFO overflow or underflow.		
0x598	JESD_PA_INT1	[7:1]	RESERVED		Reserved.	0x0	R
		0	JESD_PA_INT_CNTRL[8]		Each bit enables a JESD204B PA interrupt. Bit 8 = CGS Bit 7 = frame sync. Bit 6 = good check sum. Bit 5 = initial lane sync. Bit 4 = interlane deskew. Bit 3 = bad disparity error counter. Bit 2 = NIT error counter. Bit 1 = UEK error counter. Bit 0 = lane FIFO overflow or underflow.	0x0	R/W
0x599	TXEN_FLUSH_CTRL0	[7:1]	RESERVED		Reserved.	0x0	R
		0	SPI_FLUSH_EN		Enable datapath flush. This control is paged by the MAINDAC_PAGE control in Register 0x008.	0x1	R/W
0x705	NVM_LOADER_EN	[7:1]	RESERVED		Reserved.	0x0	R
		0	NVM_BLR_EN		Enable bootloader. This bit self clears when the boot loader completes or fails.	0x0	R/W
0x790	DACPLL_PDCTRL0	7	PLL_PD5		PLL power-down control. Write this bit to 1 if bypassing the PLL. If using the PLL, keep this value at default (0).	0x0	R/W
		[6:4]	PLL_PD4		PLL power-down control. Write this bit to 1 if bypassing the PLL. If using the PLL, keep this value at default (0).	0x0	R/W
		3	PLL_PD3		PLL power-down control. Write this bit to 1 if bypassing the PLL. If using the PLL, keep this value default (0).	0x0	R/W
		2	PLL_PD2		PLL power-down control. Write this bit to 1 if bypassing the PLL. If using the PLL, keep this value at default (0).	0x0	R/W
		1	PLL_PD1		PLL power-down control. Write this bit to 1 if bypassing the PLL. If using the PLL, write this bit to 0.	0x1	R/W
		0	PLL_PD0		PLL power-down control. Write this bit to 1 if bypassing the PLL. If using the PLL, keep this value at default (0).	0x0	R/W
0x791	DACPLL_PDCTRL1	[7:5]	RESERVED		Reserved.	0x0	R/W
		4	PLL_PD10		PLL power-down control. Write this bit to 1 if bypassing the PLL. If using the PLL, keep this value at default (0).	0x0	R/W
		3	PLL_PD9		PLL power-down control. Write this bit to 1 if bypassing the PLL. If using the PLL, keep this value at default (0).	0x0	R/W

## REGISTER DETAILS

Table 60. Register Details

Addr.	Name	Bits	Bit Name	Settings	Description	Reset	Access
		2	PLL_PD8		PLL power-down control. Write this bit to 1 if bypassing the PLL. If using the PLL, keep this value at default (0).	0x0	R/W
		1	PLL_PD7		PLL power-down control. Write this bit to 1 if bypassing the PLL. If using the PLL, keep this value at default (0).	0x0	R/W
		0	PLL_PD6		PLL power-down control. Write this bit to 1 if bypassing the PLL. If using the PLL, keep this value at default (0).	0x0	R/W
0x792	DACPLL_CTRL0	[7:2]	RESERVED		Reserved.	0x0	R
		1	D_CAL_RESET		Resets VCO calibration.	0x1	R/W
		0	D_RESET_VCO_DIV		Setting this high holds the VCO output divider in reset. This has the effect of turning off the input (and output) of the ADC clock driver.	0x0	R/W
0x793	DACPLL_CTRL1	[7:2]	RESERVED		Reserved.	0x0	R
		[1:0]	M_DIVIDER-1		Programmable predivider value for PFD (in n - 1 notation). $M\_DIVIDER = PLL\ reference\ clock/PFD\ frequency$ . For optimal spectral performance, choose an M divider setting that selects a high PFD frequency within the allowable PFD range. For 9.96 GHz $\leq$ VCO frequency $\leq$ 10.87 GHz, 25 MHz $\leq$ PFD frequency $\leq$ 225 MHz. For 9.96 GHz > VCO frequency > 10.87 GHz, 25 MHz $\leq$ PFD frequency $\leq$ 770 MHz.	0x0	R/W
				0	Divide by 1.		
				1	Divide by 2.		
				10	Divide by 3.		
				11	Divide by 4.		
0x794	DACPLL_CTRL2	[7:6]	RESERVED		Reserved.	0x0	R/W
		[5:0]	DACPLL_CP		Charge pump current control. Charge pump current = 100 $\mu$ A + code $\times$ 100 $\mu$ A.	0x4	R/W
0x795	DACPLL_CTRL3	[7:4]	RESERVED		Reserved.	0x0	R/W
		[3:0]	D_CP_CALBITS		DAC PLL optimization control.	0x8	R/W
0x796	DACPLL_CTRL4	[7:4]	PLL_CTRL0		DAC PLL optimization control.	0xD	R/W
		[3:0]	RESERVED		Reserved.	0x2	R/W
0x797	DACPLL_CTRL5	[7:6]	RESERVED		Reserved.	0x0	R/W
		[5:0]	PLL_CTRL1		DAC PLL optimization control.	0x20	R/W
0x798	DACPLL_CTRL6	7	RESERVED		Reserved.	0x0	R
		6	PLL_CTRL3		DAC PLL optimization control.	0x0	R/W
		[5:0]	PLL_CTRL2		DAC PLL optimization control.	0x1C	R/W
0x799	DACPLL_CTRL7	[7:6]	ADC_CLK_DIVIDER		ADC clock output divider.	0x0	R/W
				0	Divide by 1.		
				1	Divide by 2.		
				10	Divide by 3.		
				11	Divide by 4.		
		[5:0]	N_DIVIDER		Programmable divide by N value from 2 to 50. $N\_DIVIDER = (DAC\ frequency \times M\_DIVIDER)/(8 \times reference\ clock\ frequency)$ .	0x8	R/W
0x7A0	DACPLL_CTRL9	[7:6]	RESERVED		Reserved.	0x2	R/W
		5	D_EN_VAR_FINE_PRE		DAC PLL control.	0x0	R/W

## REGISTER DETAILS

Table 60. Register Details

Addr.	Name	Bits	Bit Name	Settings	Description	Reset	Access
		[4:3]	RESERVED		Reserved.	0x2	R/W
		2	D_EN_VAR_COARSE_PRE		DAC PLL control.	0x0	R/W
		[1:0]	RESERVED		Reserved.	0x0	R/W
0x7A2	DACPLL_CTRL10	7	RESERVED		Reserved.	0x0	R
		[6:5]	D_REGULATOR_CAL_WAIT		DAC PLL optimization control.	0x1	R/W
		[4:3]	D_VCO_CAL_WAIT		DAC PLL optimization control.	0x2	R/W
		[2:1]	D_VCO_CAL_CYCLES		DAC PLL optimization control.	0x2	R/W
		0	RESERVED		Reserved.	0x1	R/W
0x7B5	PLL_STATUS	[7:1]	RESERVED		Reserved.	0x0	R
		0	PLL_LOCK		DAC PLL lock status.	0x0	R

OUTLINE DIMENSIONS

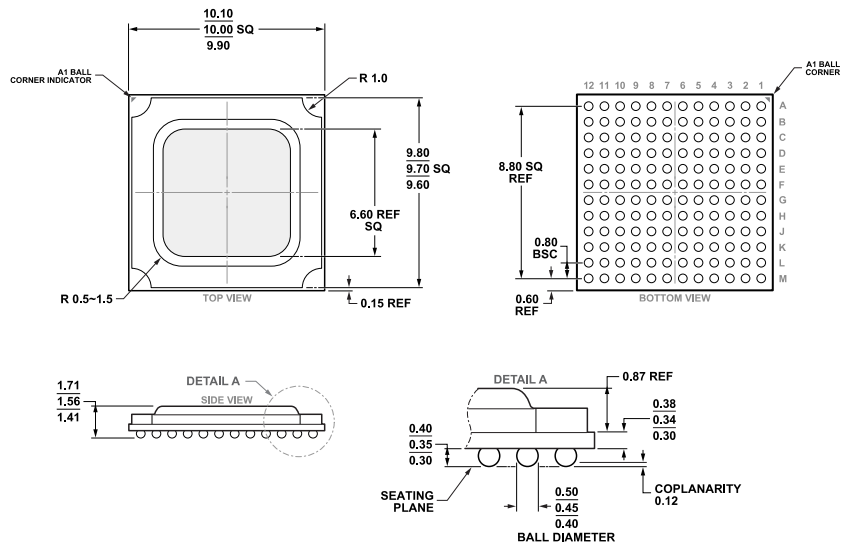

COMPLIANT TO JEDEC STANDARDS MO-275-EEAB-1.  
**Figure 86. 144-Ball Ball Grid Array, Thermally Enhanced [BGA\_ED]**  
**(BP-144-1)**  
 Dimensions shown in millimeters

Updated: March 14, 2022

ORDERING GUIDE

Model <sup>1</sup>	Temperature Range	Package Description	Packing Quantity	Package Option
AD9172BBPZ	-40°C to +85°C	144 ball (10x10x1.71 w/6.6 mm EP)	Tray	BP-144-1
AD9172BBPZRL	-40°C to +85°C	144 ball (10x10x1.71 w/6.6 mm EP)	Reel, 1500	BP-144-1

<sup>1</sup> Z = RoHS Compliant Part.

EVALUATION BOARDS

Model <sup>1</sup>	Description
AD9172-FMC-EBZ	Evaluation Board

<sup>1</sup> Z = RoHS Compliant Part.