

FAN5606

Serial LED Driver with Current-Regulated, Step-Up DC/DC Converter

Features

- Drives Up to Six LEDs in Series
- Pulse Skip PWM Mode of Operation of the Boost Circuit
- Up to 90% Peak Efficiency
- No External Schottky Diode Required
- Up to 25mA Output
- Built-in DAC for Digital Brightness Control
- LED's Current Can be Duty-Cycle-Modulated
- Digital, Analog, and PWM Brightness Control
- 2.7V to 5.5V Input Voltage Range
- 0.5MHz Operating Frequency (8MHz internal clock)
- Soft Start
- Low Shutdown Current: $I_{CC} < 1\mu A$
- LED Short Circuit Protection
- Minimal External Components Needed
- Available in an 8-lead MLP Package

Applications

- Cell Phones
- Handheld Computers
- PDAs, DSCs, MP3 Players
- Keyboard Backlights
- LED Display

Description

The FAN5606 LED driver generates regulated output currents from a battery with input voltage varying between 2.7V to 5V. An internal NMOS switch drives an external inductor, and a Schottky diode delivers the inductor's stored energy to the load. Soft start circuitry prevents excessive current drawn from the supply during power on. Any number of LEDs can be connected in series as long as the summed forward voltages do not lead to exceeding the specified operating output voltage range.

In the FAN5606 device, the internal two-bit D/A converters provide programmability of the output channel current. Analog programming of the output current is also possible in the FAN5606. To do this, ground the "B" pin and connect a resistor between the "A" pin and a fixed supply voltage. The output current can then be programmed to any desired value within its specified range. The analog version uses a single external resistor to set the current, and to turn the device ON and OFF. The device is available in an 8-lead MLP package.

Typical Applications

Analog Brightness Control

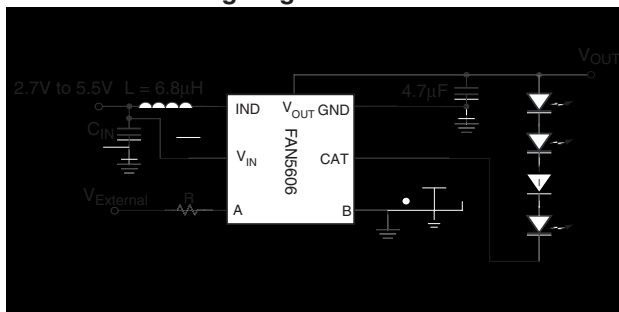

Digital Brightness Control

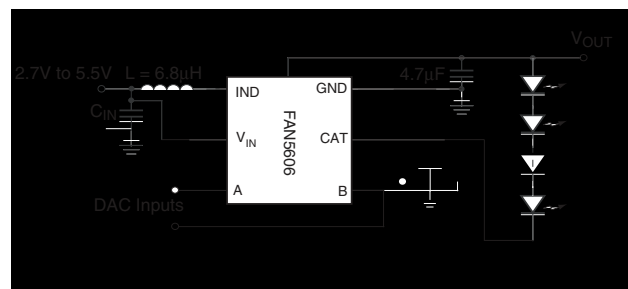

Pin Assignment

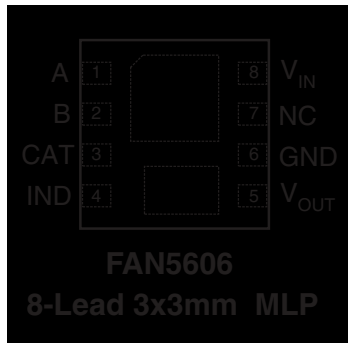

Pin Descriptions

Pin No.	Pin Name	Pin Function Description
1	A	DAC A Input
2	B	DAC B Input
3	CAT	LED Cathode
4	IND	Inductor
5	V _{OUT}	Output LED's Anode
6	GND	Ground
7	NC	No Connection
8	V _{IN}	Input Voltage

Definition of Terms

Output Current Accuracy: reflects the difference between the measured value of the output current (LED) and programmed value of this current.

$$\text{Output Current Accuracy (\%)} = \frac{(I_{\text{OUT measured}} - I_{\text{OUT programmed}}) \times 100}{I_{\text{OUT programmed}}}$$

Efficiency: is expressed as a ratio between the electrical power into the LEDs and the total power consumed from the input power supply.

$$\text{Efficiency (\%)} = \frac{(V_{\text{LED}} \times I_{\text{LED}}) \times 100}{V_{\text{IN}} \times I_{\text{IN}}}$$

Although this definition leads to a lower value than the boost converter efficiency, it more accurately reflects better system performance, from the user's point-of-view.

Absolute Maximum Ratings

Parameter	Min	Typ	Max	Unit
V _{IN} , A, B Voltage to GND	-0.3		6.5	V
V _{OUT} , CAT Voltage to GND	-0.3		24	V
Any LED Short Circuit Duration (Anode to Cathode)			Indefinite	
Lead Soldering Temperature (10 seconds)			300	°C
Thermal Resistance θ_{jC}		8		°C/W
Operating Junction Temperature Range			150	°C
Storage Temperature Range	-55		150	°C
Electrostatic Discharge (ESD) Protection (Note 1, 2)	HBM	4		kV
	CDM	1		

Electrical Characteristics

V_{IN} = 2.7V to 5.5V, T_A = 25°C, unless otherwise noted.

Parameter	Conditions	Min.	Typ.	Max.	Units
Output Current Accuracy	A = HIGH, B = HIGH	$0.9 \times I_{NOM}$	$I_{NOM} = 20$	$1.1 \times I_{NOM}$	mA
Efficiency (AVG)	V _{IN} > 3.0V		80		%
Switching Frequency			0.5		MHz
Multiplication Ratio (Note 3)		850	1000	1150	
Supply Current in OFF mode	V _A = V _B = 0V		0.1		µA
Input A Threshold	Digital Mode	High	V _{IN} -0.7	V _{IN}	V
		Low	0	0.6	
	Analog Mode		1.2		
Input B Threshold	Digital Mode	High	$0.6 \times V_{IN}$	V _{IN}	V
		Low	0	$0.3 \times V_{IN}$	

Recommended Operating Conditions

Parameter	Min	Typ	Max	Unit
Input Voltage Range	2.7		5.5	V
Operating Ambient Temperature Range	-40	25	85	°C
Output Voltage Range	V _{IN}		18	V

Notes:

- Using Mil Std. 883E, method 3015.7 (Human Body Model) and EIA/JESD22C101-A (Charge Device Model).
- Avoid positive polarity ESD stress at the cathode of the internal Schottky diode.
- Multiplication Ratio is $I_{LED} / I_{INPUT A}$.

Block Diagram

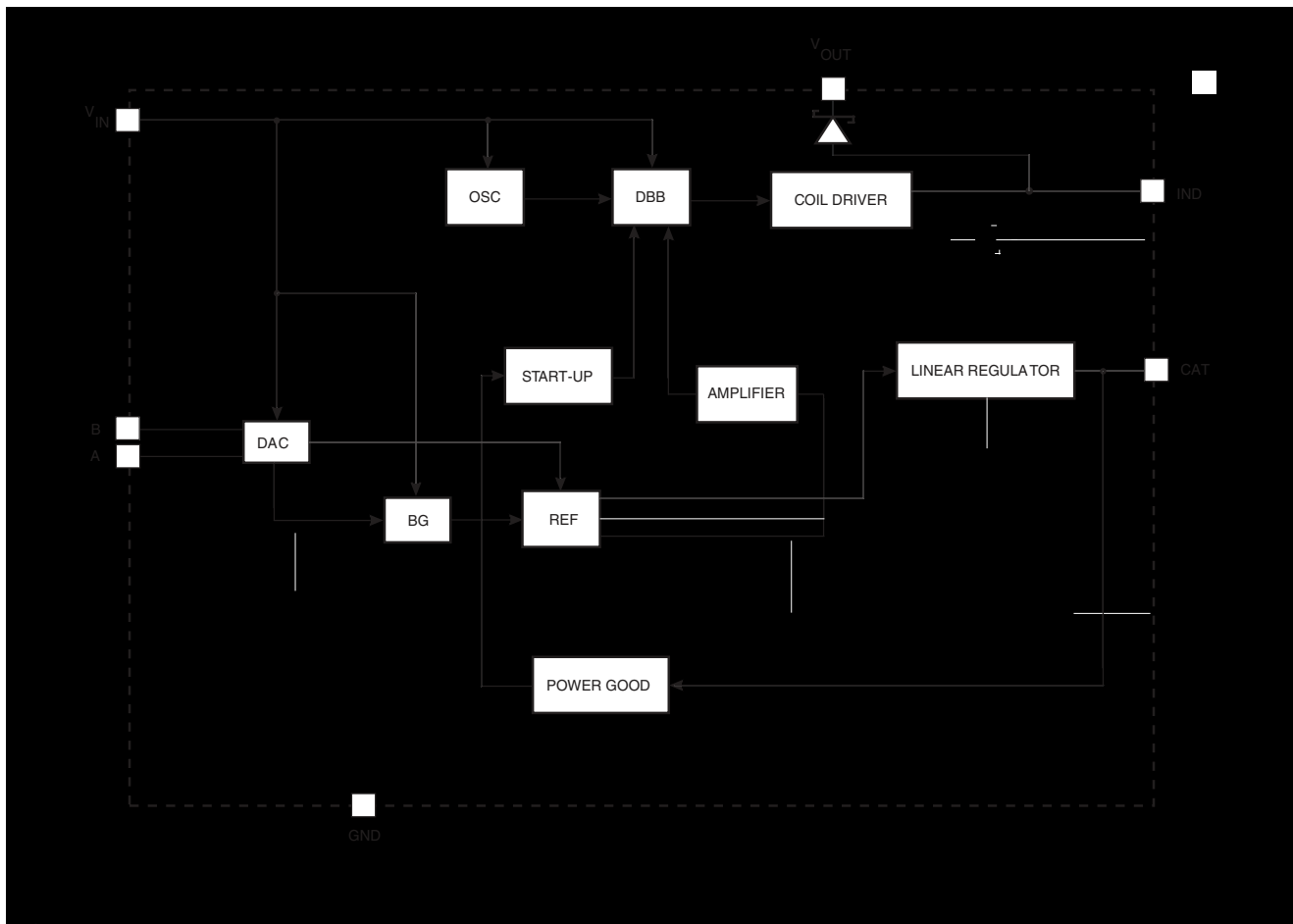

Circuit Description

When the input voltage is connected to V_{IN} pin, the system is turned on, the bandgap reference acquires its nominal voltage and the soft-start cycle begins. Once "power good" is achieved (0.5mA in the diodes), the soft-start cycle stops and the boost voltage increases to generate the desired current selected by the input control pins.

The FAN5606 DC/DC converter automatically adjusts its internal duty cycle to achieve high efficiency. If the output external capacitor is shorted, the Schottky diode can be damaged, therefore such a condition should be avoided.

LED Brightness Control

The inputs A and B can be digitally controlled LOW (GND) and HIGH (V_{CC}) signals. In analog mode, A input is connected to an external stable voltage source via an external resistor and B input is connected to ground. The current flowing through the resistor is scaled by a factor of approximately 1000.

Digital Control

The FAN5606's digital decoder allows selection of the following modes of operation: OFF, 5mA, 10mA, 20mA per branch.

A	0	1	0	1
B	0	0	1	1
I_{LED}	OFF	5mA	10mA	20mA

Analog Control with PWM

In analog control mode, the LED current can go up to 25mA. Input A is used to control the LED currents. Input B should be connected to GND (logic level "0"). An external resistor (R) is connected from A to a stable voltage source ($V_{EXTERNAL}$) to control the LED current, I_{LED} . The I_{LED} is given by the formula or the graph below:

$$I_{LED} = \left(\frac{V_{EXTERNAL} - V_{REF}}{R} \right) \times \text{Multiplication Ratio}$$

Where $V_{Ref} = 1.22V$

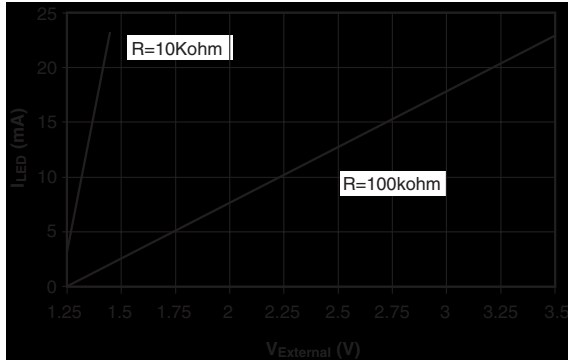

If the analog input A is driven in digital mode by an open drain output, it is important to choose the appropriate value of the pull-up resistor. Its resistance should be low enough to ensure less than 0.7V dropout, hence $V_A > (V_{IN} - 0.7V)$, as required for HIGH logic level:

$$R_{pull-up} < \frac{700mV}{60\mu A} = 11k\Omega$$

Pulse-Width-Modulation (PWM) Control

A variable duty cycle (δ) can modulate any DAC input. Care should be taken not to use a too low frequency, otherwise a flickering effect may occur. The minimum range is 100Hz to 1KHz. For a maximum range of LED current, both A and B inputs can be modulated at the same time.

Open Circuit Protection

A built-in over voltage protection circuit prevents the device from being damaged when it is powered up with no load. This circuit reduces the boost converter duty cycle, to a minimum thus limiting the output voltage to a safe value when no load condition is detected. However, the FAN5606 can be damaged when a full load (Six LEDs driven by 20mA) is suddenly disconnected from V_{OUT} . To protect the FAN5606 against this unlikely event, an external 24 V Zener diode can be connected between V_{OUT} and GND.

Shutdown Mode

The device can be disabled by applying LOW logic level voltage to the A and B inputs. In Shutdown mode the supply current is reduced to less than 1 μ A.

PWM Control

1. A is PWM Controlled, B is Low. $I_{LED} (Average) = \delta \times 5mA$, where δ is Duty Cycle. (Note 4)

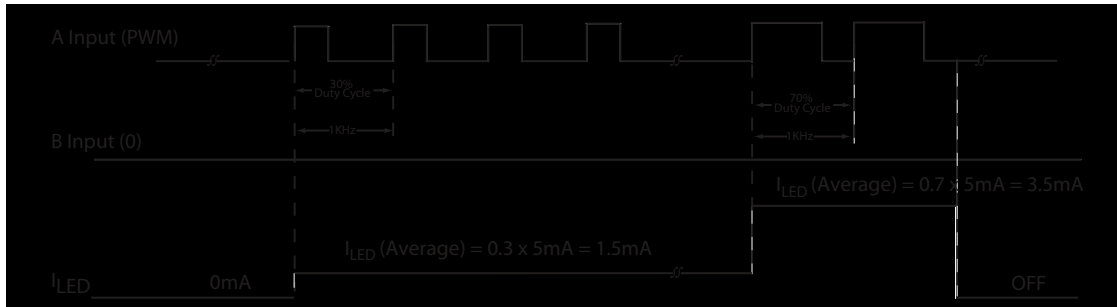

2. A is High and B is PWM. $I_{LED} (Average) = 5mA + \delta \times 15mA$, where δ is Duty Cycle. (Note 5, 6)

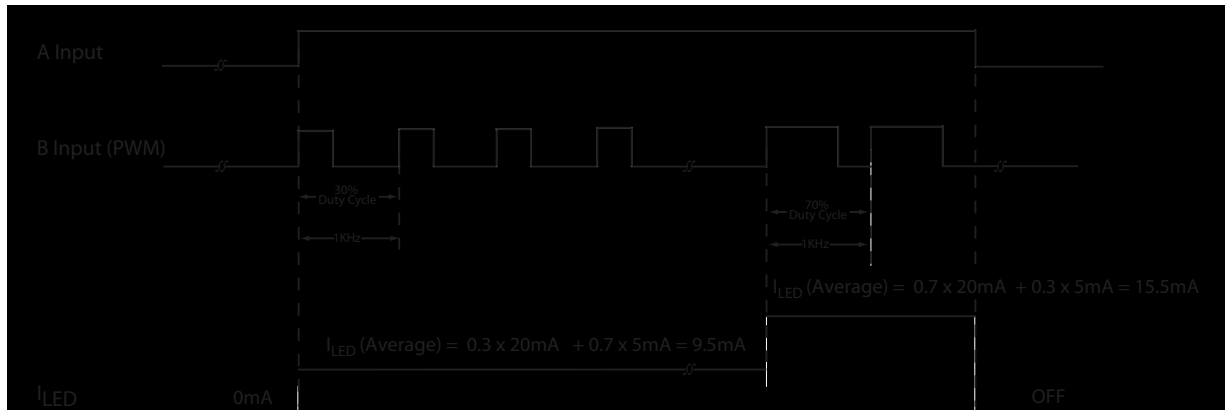

PWM Control (Continued)

3. **A and B are PWM.** $I_{LED} \text{ (Average)} = \delta \times 20\text{mA}$, where δ is Duty Cycle.

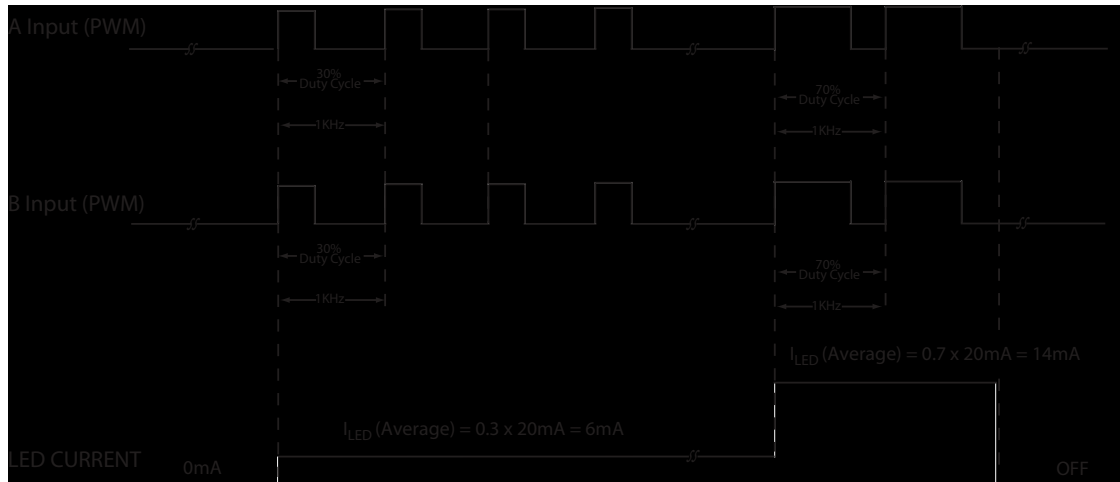

Notes:

4. Proportionally select the duty cycle to achieve a typical LED current between 1mA to 4mA.
5. Maximum PWM frequency can be up to 30KHz.
6. Proportionally select the duty cycle to achieve a typical LED current between 1mA and 19mA.

Applications Information

Inductor Selection

The inductor is one of the main components required by the boost converter to store energy. The amount of energy stored in the inductor and transferred to the load is controlled by the regulator using PWM and pulse skipping techniques. In most cases, the FAN5606 operates the inductor in discontinuous conduction mode.

To ensure proper operation of the current regulator over the entire range of conditions, the inductor should be selected based on the maximum required power (P_{OUT}) and the minimum input voltage (V_{IN}).

$$L < \frac{(V_{IN})^2 \times F}{P_{OUT}}$$

where units of L , V_{IN} , and P_{OUT} are in μH , Volt, and Watt, respectively and $F = 0.4$ is a factor depending upon the FAN5606 architecture.

The above relation is applicable up to $P_{OUT} = 0.6\text{W}$ and $L = 4.3\mu\text{H}$, or greater. The peak current in the inductor is:

$$I = \frac{T_{ON_Max} \times V_{IN_Max}}{L}$$

where $T_{ON_Max} = 1.25\mu\text{s}$. The recommended inductor for driving upto 6 LEDs, type QTLP670CiW is $L = 6.8\mu\text{H}$ rated at minimum 0.5A.

Low ESR capacitors should be used to minimize the input and output ripple voltage. Use of $C_{IN} = 4.7\mu\text{F}/6.3\text{V}$ and $C_{OUT} = 4.7\mu\text{F}/25\text{V}$ type X5R/X7R multi layer ceramic capacitor are recommended.

A larger value input capacitor placed as close as possible to FAN5606 may be needed to reduce the input voltage ripple in noise sensitive applications. An additional LC filter between the battery and the FAN5606 input can help to further reduces the battery ripple to the level required by a particular application.

Typical Performance Characteristics

$T_A = 25\text{ }^\circ\text{C}$, $C_{IN} = 47\mu\text{F}$, $C_{OUT} = 4.7\mu\text{F}$, $L = 6.8\mu\text{H}$, unless otherwise noted.

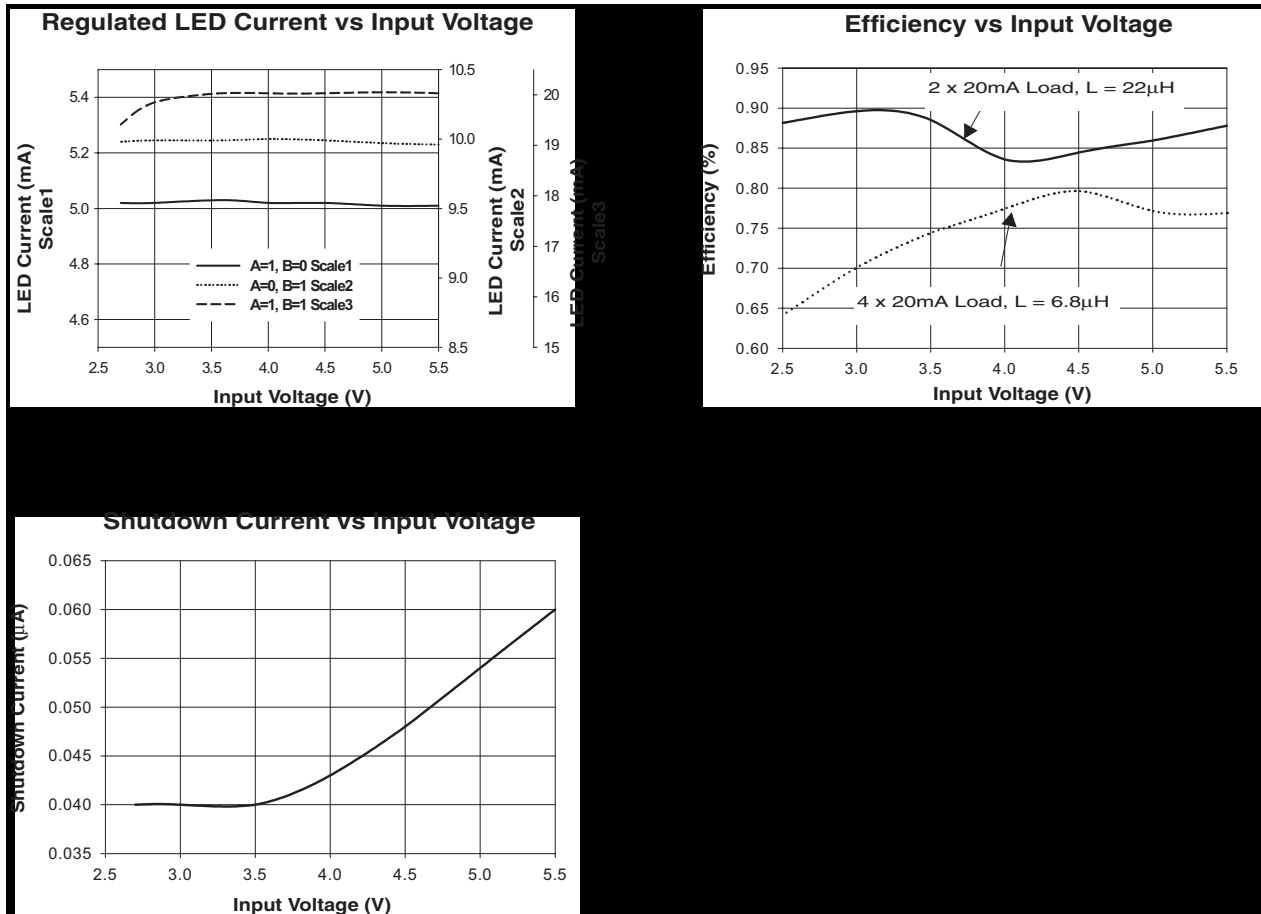

Mechanical Dimensions

3x3mm 8-Lead MLP (Internal Schottky Diode)

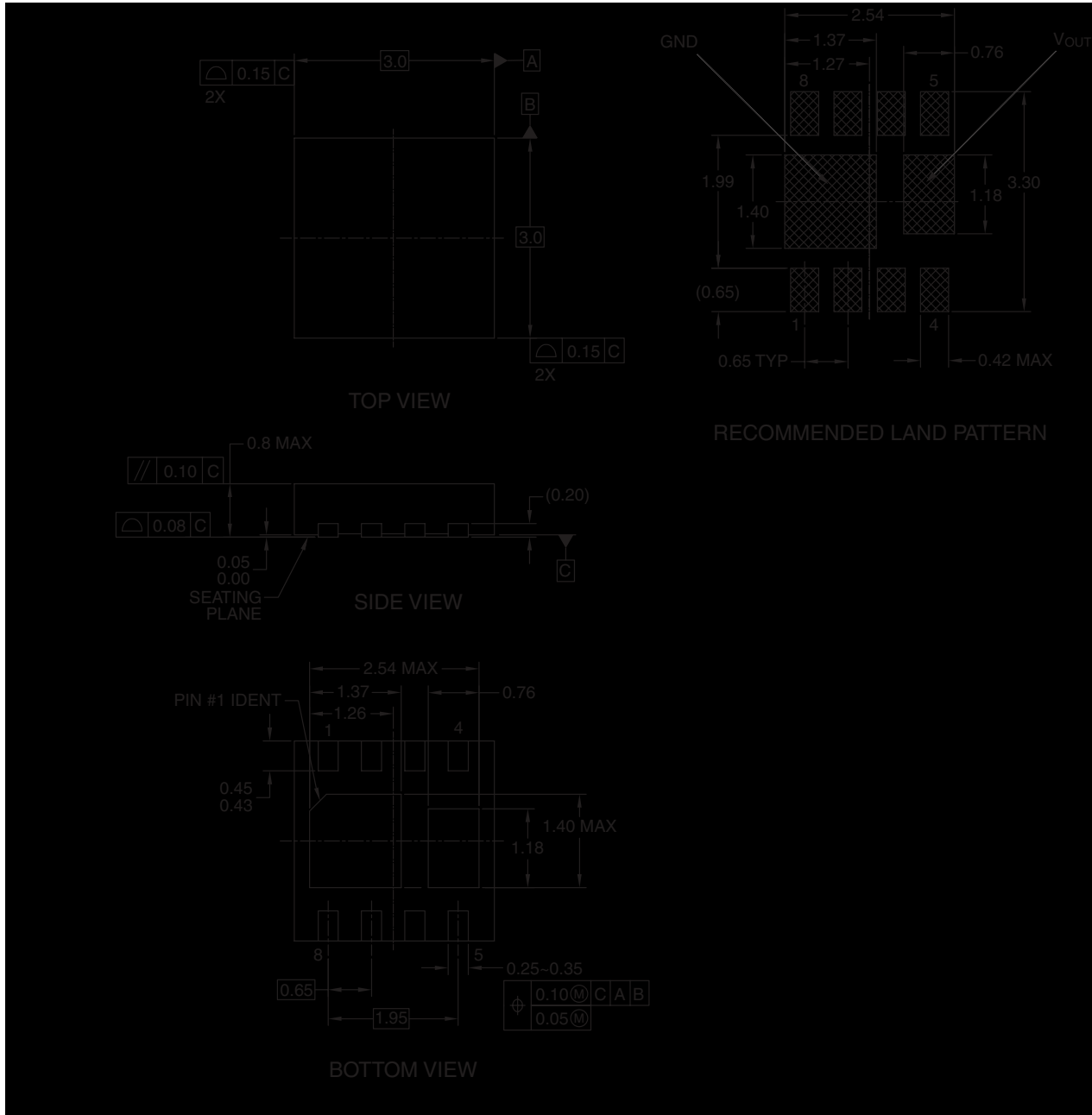

NOTES:

- A. CONFORMS TO JEDEC REGISTRATION MO-229, VARIATION VEEC, DATED 11/2001
- B. DIMENSIONS ARE IN MILLIMETERS.
- C. DIMENSIONS AND TOLERANCES PER ASME Y14.5M, 1994

Ordering Information

Product Number	Package Type	Order Code
FAN5606	8-Lead 3x3mm MLP	FAN5606DMPX

DISCLAIMER

FAIRCHILD SEMICONDUCTOR RESERVES THE RIGHT TO MAKE CHANGES WITHOUT FURTHER NOTICE TO ANY PRODUCTS HEREIN TO IMPROVE RELIABILITY, FUNCTION OR DESIGN. FAIRCHILD DOES NOT ASSUME ANY LIABILITY ARISING OUT OF THE APPLICATION OR USE OF ANY PRODUCT OR CIRCUIT DESCRIBED HEREIN; NEITHER DOES IT CONVEY ANY LICENSE UNDER ITS PATENT RIGHTS, NOR THE RIGHTS OF OTHERS.

LIFE SUPPORT POLICY

FAIRCHILD'S PRODUCTS ARE NOT AUTHORIZED FOR USE AS CRITICAL COMPONENTS IN LIFE SUPPORT DEVICES OR SYSTEMS WITHOUT THE EXPRESS WRITTEN APPROVAL OF THE PRESIDENT OF FAIRCHILD SEMICONDUCTOR CORPORATION. As used herein:

1. Life support devices or systems are devices or systems which, (a) are intended for surgical implant into the body, or (b) support or sustain life, and (c) whose failure to perform when properly used in accordance with instructions for use provided in the labeling, can be reasonably expected to result in a significant injury of the user.
2. A critical component in any component of a life support device or system whose failure to perform can be reasonably expected to cause the failure of the life support device or system, or to affect its safety or effectiveness.

www.fairchildsemi.com