

## Data Sheet

**Customer:**

**Product:** Wire Wound Chip Inductor(Ferrite) –NL Series

**Sizes.:** 0402/0603/0805/1008/1210/1812/2220

**Issued Date:** 19-Aug-22

**Edition:** REV.C8



VIKING TECH CORPORATION  
光韻科技股份有限公司  
No.70, Guangfu N. Rd., Hukou  
Township, Hsinchu County  
303, Taiwan (R.O.C)

TEL:886-3-5972931  
FAX:886-3-5972935•886-3-5973494  
E-mail:sales@viking.com.tw

VIKING TECH CORPORATION KAOHSIUNG BRANCH  
光韻科技股份有限公司高雄分公司  
No.248-3, Sin-Sheng Rd., Cian-Jhen Dist., Kaohsiung,  
806, Taiwan

TEL:886-7-8217999  
FAX:886-7-8228229  
E-mail:sales@viking.com.tw

VIKING ELECTRONICS (WUXI) CO., LTD.  
光韻電子(無錫)有限公司  
No.22 Xixia Road, Machinery & Industry Park,  
National Hi-Tech Industrial Development Zone  
of Wuxi, Wuxi, Jiangsu Province, China  
Zip Code:214028  
TEL:86-510-85203339  
FAX:86-510-85203667•86-510-85203977  
E-mail:china@viking.com.tw

Produced by (QC)	Checked (QC)	Approved by (QC)	Prepared by (Sales)	Accepted by (Customer)
19-Aug-22	19-Aug-22	19-Aug-22		
<i>Mandy Chen</i>	<i>Ben Chang</i>	<i>Ben Chang</i>		

## Wire Wound Chip Inductor (Ferrite)

### ■ Features

- Very strong solderability by flow soldering, soldering iron or wave soldering
- Highly accurate dimensions, can be mounted automatically
- Terminals are highly resistant to pull forces
- Highly resistant to mechanical shocks and pressure
- Highly reliable in environments of sudden temperature change and humidity.
  - Super Q characteristics
- Moisture sensitivity level 1 (only NL10(C) / NL12(C))



### ■ Applications

- Micro Televisions, Liquid Crystal Televisions, Video Cameras, Portable VCRs, Car Radios, Car Stereos, Thin Tape Radios, Television Tuners, Mobile Telephones, Radio and Other Electronic Devices



### ■ Construction

#### Molding Type

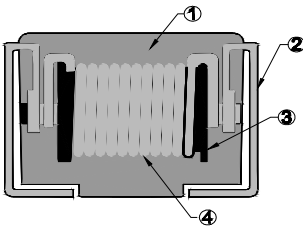

① Molded resin	③ Ferrite core
② Electrode (Tinned Copper Wire)	④ Magnet wire

#### Open Type

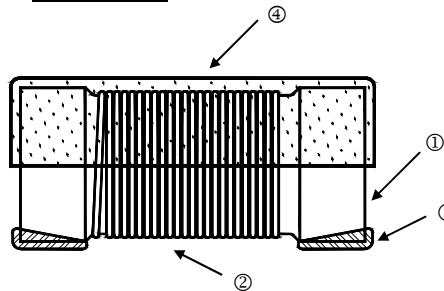

① Ferrite core	③ Electrode (Ag/Pd+Ni+Sn)
② Magnet wire	④ UV Glue

### ■ Part Numbering

NL	05	K	T	C	1R0
Product Type	Dimensions (LxW)	Inductance Tolerance	Packaging Code	Current	Inductance
	02: 0402 03: 0603 05: 0805 08: 1008 10: 1210 12: 1812 20: 2220	J: ±5% K: ±10% M: ±20%	T: Taping Reel	: Standard C: Large Current	R12: 120nH R27: 270nH 2R7: 2700nH 100: 10µH

**Wire Wound Chip Inductor (Ferrite)**

**■ Dimensions**

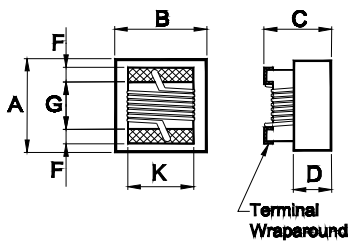

Figure 1

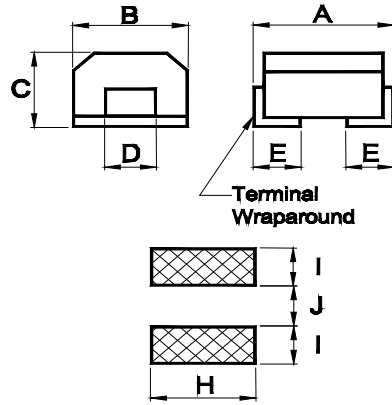

Figure 2

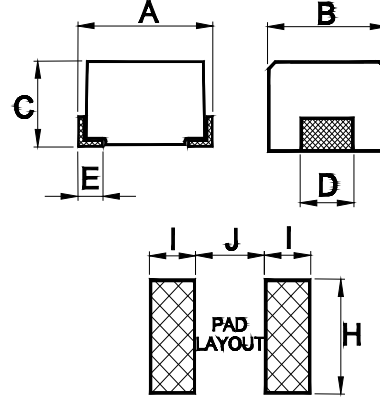

Figure 3

Unit: mm

Type	Size (Inch)	Figure	A	B	C	D	E	F	G	H	I	J	K	Weight (g) (1000pcs)
NL02	0402	1	1.02±0.1	0.56±0.1	0.56±0.1	0.25	-	0.23	0.54	0.65	0.38	0.44	0.50	1
NL03	0603	1	1.80 max	1.20 max	1.00 max	0.45	-	0.33	0.95	1.02	0.64	0.64	1.05	9.6
NL05	0805	1	2.40 max	1.71 max	1.45 max	0.65	-	0.44	1.02	1.78	1.02	0.76	1.27	14
NL08	1008	1	2.92 max	2.79 max	2.10 max	1.20	-	0.45	1.52	2.54	1.02	1.27	2.03	30
NL10	1210	2	3.2±0.4	2.5±0.2	2.2±0.2	1.0±0.2	0.6-0/+0.3	-	-	1.40	1.00	1.80	-	40
NL12	1812	2	4.5±0.3	3.2±0.2	3.2±0.2	1.20	1.0-0/+0.3	-	-	1.60	1.50	2.20	-	160
NL20	2220	3	5.6±0.3	5.0±0.2	4.0±0.3	4±0.2	0.7±0.2	-	-	4.50	2.00	4.00	-	300
NL05(L)	0805	1	2.29 max	1.73 max	1.00 max	0.51	-	0.44	1.02	1.78	1.02	0.76	1.27	14
NL03(C)	0603	1	1.80 max	1.20 max	1.10 max	0.45	-	0.33	0.95	1.02	0.64	0.64	1.05	9.6
NL05(C)	0805	1	2.40 max	1.71 max	1.45 max	0.65	-	0.44	1.02	1.78	1.02	0.76	1.27	14
NL08(C)	1008	1	2.92 max	2.79 max	2.10 max	1.30	-	0.45	1.52	2.54	1.02	1.27	2.03	30
NL10(C)	1210	2	3.2±0.4	2.5±0.2	2.2±0.2	1.0±0.2	0.6-0/+0.3	-	-	1.40	1.00	1.80	-	40
NL12(C)	1812	2	4.5±0.3	3.2±0.2	3.2±0.2	1.20	1.0-0/+0.3	-	-	1.60	1.50	2.20	-	160
NL20(C)	2220	3	5.6±0.3	5.0±0.2	4.0±0.3	4±0.2	0.7±0.2	-	-	4.50	2.00	4.00	-	300

**■ Color Coding**

0603 / 0805 / 1008 Type (except NL02)

Because of small sizes, these parts are marked with a single color dot.

The inductance value represented by the dot is shown on the data page for each type.

0603/0805

1st Code

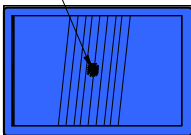

Color Coding

1008

1st Code 3rd Code

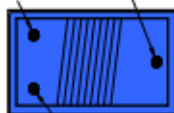

2nd Code

Color Coding

**Standard Electrical Specifications**



NL02 Wire Wound Chip Inductors (Ferrite / Open Type) / Standard Type(□:Tolerance):

Part No	Inductance (μH)	Tolerance	Q typ.	Test Freq. (MHz)	SRF (MHz) typ.	DCR (Ω) max.	Irms (mA) max.
NL02□T18N	0.018	±5, ±10%	10	100	2600	0.055	1600
NL02□T20N	0.020	±5, ±10%	10	100	2600	0.050	1600
NL02□T22N	0.022	±10%	10	100	2500	0.072	1300
NL02□T33N	0.033	±5, ±10%	10	100	2300	0.060	1400
NL02□T36N	0.036	±5, ±10%	10	100	2300	0.092	1000
NL02□T39N	0.039	±5, ±10%	10	100	2200	0.150	830
NL02□T51N	0.051	±10%	10	100	1930	0.070	1100
NL02□T56N	0.056	±10%	10	100	1900	0.125	900
NL02□T72N	0.072	±5, ±10%	10	100	1650	0.100	900
NL02□T78N	0.078	±5, ±10%	10	100	1600	0.190	850
NL02□TR10	0.10	±10%	9	100	1400	0.160	900
NL02□TR14	0.14	±5, ±10%	11	50	1220	0.260	540
NL02□TR18	0.18	±10%	11	50	1150	0.330	560
NL02□TR20	0.20	±5, ±10%	11	50	1000	0.440	400
NL02□TR22	0.22	±5, ±10%	11	50	1150	0.530	380
NL02□TR25	0.25	±5, ±10%	11	25	900	0.360	520
NL02□TR27	0.27	±10%	11	25	860	0.550	360
NL02□TR30	0.30	±5, ±10%	11	25	860	0.410	420
NL02□TR33	0.33	±5, ±10%	11	7.9	820	0.680	350
NL02□TR36	0.36	±5, ±10%	11	7.9	810	0.575	360
NL02□TR39	0.39	±5, ±10%	11	7.9	760	0.890	300
NL02□TR42	0.42	±5, ±10%	11	7.9	700	1.100	340
NL02□TR47	0.47	±10%	11	7.9	650	0.730	310
NL02□TR56	0.56	±5, ±10%	11	7.9	600	1.100	200

NL03 Wire Wound Chip Inductors (Ferrite / Open Type) / Standard Type



Codes	Inductance (μH)	Tolerance	Q typ.	Test Freq. (MHz)	SRF (MHz) typ.	DCR (Ω) max.	IDC (mA) max.	Color Code
R27	0.27	±10, ±20%	13	7.9	900	0.338	950	Green
R47	0.47	±10, ±20%	13	7.9	900	0.338	920	Blue
R68	0.68	±10, ±20%	13	7.9	650	0.351	920	Violet
R78	0.78	±10, ±20%	16	7.9	410	0.364	920	Gray
1R0	1.0	±10, ±20%	16	7.9	390	0.416	860	Black
1R5	1.5	±10, ±20%	16	7.9	160	0.520	720	Brown
1R8	1.8	±10, ±20%	16	7.9	121	0.559	640	Red
2R2	2.2	±10, ±20%	16	7.9	103	0.728	600	Orange
2R7	2.7	±10, ±20%	16	7.9	72	0.806	540	Yellow
3R3	3.3	±10, ±20%	16	7.9	66	0.910	500	Green
3R9	3.9	±10, ±20%	16	7.9	61	1.079	460	Blue
4R7	4.7	±10, ±20%	16	7.9	51	1.261	400	Violet
5R6	5.6	±10, ±20%	16	7.9	47	1.430	380	Gray
6R8	6.8	±10, ±20%	16	7.9	43	1.950	340	White
8R2	8.2	±10, ±20%	16	7.9	40	2.184	300	Black
100	10	±10, ±20%	14	2.5	36	2.405	280	Brown
120	12	±10, ±20%	14	2.5	32	2.964	260	Red
150	15	±10, ±20%	14	2.5	29	3.380	240	Orange
180	18	±10, ±20%	14	2.5	28	3.770	220	Yellow
220	22	±10, ±20%	14	2.5	24	4.693	200	Green
270	27	±10, ±20%	14	2.5	20	6.760	140	Blue
330	33	±10, ±20%	14	2.5	15	8.580	120	Violet
470	47	±10, ±20%	12	2.5	11	14.560	100	Gray

NL05 Wire Wound Chip Inductors (Ferrite / Open Type) / Standard Type

Codes	Inductance (μH)	Tolerance	Q min.	Test Freq. (MHz)	SRF (MHz) min.	DCR (Ω) max.	IDC (mA) max.	Color Code
78N	0.078	±5, ±10%	13	7.9	1500	0.076	2000	Gray
R10	0.10	±10%	20	25	1400	0.10	1700	White
R11	0.11	±10%	25	25	1200	0.10	1700	White
R12	0.12	±5, ±10%	25	25	1000	0.18	1500	Violet
R15	0.15	±5, ±10%	25	25	1000	0.18	1400	Gray
R18	0.18	±5, ±10%	30	25	1000	0.20	1400	Black
R22	0.22	±5, ±10%	30	25	830	0.25	1350	Brown
R27	0.27	±5, ±10%	30	25	800	0.38	1300	Red
R33	0.33	±5, ±10%	30	25	750	0.35	1200	Orange
R39	0.39	±5, ±10%	30	25	700	0.35	1160	Yellow
R47	0.47	±5, ±10%	30	25	690	0.40	1100	Green
R56	0.56	±5, ±10%	30	25	640	0.40	1040	Blue
R62	0.62	±5, ±10%	30	25	640	0.45	980	Brown
R68	0.68	±5, ±10%	30	25	510	0.50	900	Violet
R75	0.75	±5, ±10%	30	25	500	0.50	900	Violet
R82	0.82	±5, ±10%	30	25	500	0.50	900	Gray
R91	0.91	±5, ±10%	30	25	500	0.55	900	Yellow
1R0	1.0	±5, ±10%	20	7.9	470	0.50	840	White
1R2	1.2	±5, ±10%	20	7.9	400	0.75	800	Black
1R5	1.5	±5, ±10%	25	7.9	400	1.00	720	Brown
1R8	1.8	±5, ±10%	25	7.9	230	1.00	660	Red
2R2	2.2	±5, ±10%	25	7.9	200	1.05	600	Orange
2R7	2.7	±5, ±10%	25	7.9	130	1.18	500	Yellow
3R3	3.3	±5, ±10%	25	7.9	160	1.26	480	Green
3R9	3.9	±5, ±10%	25	7.9	130	1.75	440	Blue
4R7	4.7	±5, ±10%	25	7.9	120	1.87	390	Violet
5R6	5.6	±5, ±10%	25	7.9	90	2.00	340	Gray
6R8	6.8	±5, ±10%	25	7.9	55	2.15	300	White
8R2	8.2	±5, ±10%	25	7.9	40	2.37	280	Black
100	10	±5, ±10%	16	2.5	40	2.55	260	Brown
120	12	±5, ±10%	16	2.5	37	2.80	220	Red
150	15	±5, ±10%	16	2.5	30	3.80	200	Orange
180	18	±5, ±10%	16	2.5	23	4.48	180	Yellow
220	22	±5, ±10%	16	2.5	20	6.30	160	Green
270	27	±5, ±10%	16	2.5	19	6.85	140	Blue
330	33	±5, ±10%	16	2.5	18	7.60	120	Violet
390	39	±5, ±10%	15	2.5	16	8.20	100	Gray
470	47	±5, ±10%	13	2.5	13	13.10	60	White



NL08 Wire Wound Chip Inductors (Ferrite / Open Type) / Standard Type

Codes	Inductance (μH)	Tolerance	Q min.	Test Freq. (MHz)	SRF (MHz) min.	DCR (Ω) max.	IDC (mA) max.	Color Code		
R10	0.10	±10%	25	25	930	0.20	1300	Brown	Black	Brown
R12	0.12	±5, ±10%	26	25	930	0.30	1000	Brown	Red	Brown
R15	0.15	±5, ±10%	26	25	930	0.30	1000	Brown	Green	Brown
R18	0.18	±5, ±10%	30	25	930	0.30	960	Brown	Gray	Brown
R20	0.20	±5, ±10%	30	25	735	0.30	960	Red	Black	Brown
R22	0.22	±5, ±10%	27	25	750	0.40	880	Red	Red	Brown
R27	0.27	±5, ±10%	29	25	700	0.42	900	Red	Violet	Brown
R33	0.33	±5, ±10%	30	25	600	0.42	900	Orange	Orange	Brown
R39	0.39	±5, ±10%	30	25	480	0.45	920	Orange	White	Brown
R47	0.47	±5, ±10%	30	25	470	0.50	920	Yellow	Violet	Brown
R56	0.56	±5, ±10%	30	25	460	0.55	900	Green	Blue	Brown
R62	0.62	±5, ±10%	30	25	460	0.55	900	Blue	Red	Brown
R68	0.68	±5, ±10%	30	25	420	0.55	880	Blue	Gray	Brown
R75	0.75	±5, ±10%	30	25	420	0.65	880	Violet	Green	Brown
R82	0.82	±5, ±10%	30	25	380	0.65	840	Gray	Red	Brown
R91	0.91	±5, ±10%	30	25	400	0.65	840	White	Brown	Brown
1R0	1.0	±5, ±10%	25	7.9	300	0.60	800	Brown	Black	Red
1R2	1.2	±5, ±10%	25	7.9	280	0.74	800	Brown	Red	Red
1R5	1.5	±5, ±10%	25	7.9	245	0.85	780	Brown	Green	Red
1R8	1.8	±5, ±10%	25	7.9	240	0.92	780	Brown	Gray	Red
2R2	2.2	±5, ±10%	25	7.9	205	1.10	760	Red	Red	Red
2R7	2.7	±5, ±10%	25	7.9	187	1.22	760	Red	Violet	Red
3R3	3.3	±5, ±10%	25	7.9	165	1.37	740	Orange	Orange	Red
3R9	3.9	±5, ±10%	25	7.9	144	1.66	700	Orange	White	Red
4R7	4.7	±5, ±10%	25	7.9	110	1.68	660	Yellow	Violet	Red
5R6	5.6	±5, ±10%	25	7.9	88	1.75	640	Green	Blue	Red
6R8	6.8	±5, ±10%	25	7.9	70	1.85	640	Blue	Gray	Red
8R2	8.2	±5, ±10%	25	7.9	57	2.00	600	Gray	Red	Red
100	10	±5, ±10%	25	7.9	55	2.32	600	Brown	Black	Orange
120	12	±5, ±10%	15	2.5	52	2.99	560	Brown	Red	Orange
150	15	±5, ±10%	15	2.5	49	3.42	480	Brown	Green	Orange
180	18	±5, ±10%	15	2.5	48	4.65	420	Brown	Gray	Orange
220	22	±5, ±10%	15	2.5	25	5.12	420	Red	Red	Orange
270	27	±5, ±10%	15	2.5	23	5.76	420	Red	Violet	Orange
330	33	±5, ±10%	15	2.5	17	6.44	400	Orange	Orange	Orange
390	39	±5, ±10%	15	2.5	15	6.85	380	Orange	White	Orange
470	47	±5, ±10%	14	2.5	13	9.94	260	Yellow	Violet	Orange
560	56	±5, ±10%	14	2.5	10	10.7	280	Green	Blue	Orange
680	68	±5, ±10%	14	2.5	8	12.8	260	Blue	Gray	Orange
820	82	±5, ±10%	14	2.5	8	18.3	240	Gray	Red	Orange
101	100	±5, ±10%	8	1	7	19.6	200	Brown	Black	Yellow

NL10 Wire Wound Chip Inductors (Ferrite / Molding Type) / Standard Type

Codes	Inductance (μH)	Tolerance	Q min.	Test Freq. (MHz)	SRF (MHz) typ.	DCR (Ω) max.	IDC (mA) max.
R18	0.18	±20%	30	25.2	685	0.28	450
R22	0.22	±20%	30	25.2	560	0.32	450
R27	0.27	±20%	30	25.2	525	0.36	450
R33	0.33	±20%	30	25.2	520	0.40	450
R39	0.39	±20%	30	25.2	470	0.45	450
R47	0.47	±20%	30	25.2	430	0.50	450
R56	0.56	±20%	30	25.2	395	0.55	450
R68	0.68	±20%	30	25.2	370	0.60	450
R82	0.82	±20%	30	25.2	310	0.65	450
1R0	1.0	±5%,±10%	30	7.96	295	0.70	400
1R2	1.2	±5%,±10%	30	7.96	255	0.75	390
1R5	1.5	±5%,±10%	30	7.96	160	0.85	370
1R8	1.8	±5%,±10%	30	7.96	125	0.90	350
2R2	2.2	±5%,±10%	30	7.96	100	1.00	320
2R7	2.7	±5%,±10%	30	7.96	65	1.10	290
3R3	3.3	±5%,±10%	30	7.96	55	1.20	260
3R9	3.9	±5%,±10%	30	7.96	50	1.30	250
4R7	4.7	±5%,±10%	30	7.96	45	1.50	220
5R6	5.6	±5%,±10%	30	7.96	40	1.60	200
6R8	6.8	±5%,±10%	30	7.96	35	1.80	180
8R2	8.2	±5%,±10%	30	7.96	30	2.00	170
100	10	±5%,±10%	30	2.52	30	2.10	150
120	12	±5%,±10%	30	2.52	28	2.50	140
150	15	±5%,±10%	30	2.52	25	2.80	130
180	18	±5%,±10%	30	2.52	22	3.30	120
220	22	±5%,±10%	30	2.52	19	3.70	110
270	27	±5%,±10%	30	2.52	18	5.00	80
330	33	±5%,±10%	30	2.52	17	5.60	70
390	39	±5%,±10%	30	2.52	15	6.40	65
470	47	±5%,±10%	30	2.52	14	7.00	60
560	56	±5%,±10%	30	2.52	13	8.00	55
680	68	±5%,±10%	30	2.52	11	9.00	50
820	82	±5%,±10%	30	2.52	10	10.00	45
101	100	±5%,±10%	20	0.796	9	10.00	40
121	120	±5%,±10%	20	0.796	8	11.00	70
151	150	±5%,±10%	20	0.796	7	15.00	65



NL12 Wire Wound Chip Inductors (Ferrite / Molding Type) / Standard Type

Codes	Inductance (μH)	Tolerance	Q min.	Test Freq. (MHz)	SRF (MHz) typ.	DCR (Ω) max.	IDC (mA) max.
R18	0.18	±20%	35	25.2	570.0	0.24	700
R22	0.22	±20%	40	25.2	505.0	0.25	665
R27	0.27	±20%	40	25.2	450.0	0.26	635
R33	0.33	±20%	40	25.2	425.0	0.28	605
R39	0.39	±20%	40	25.2	390.0	0.30	575
R47	0.47	±20%	40	25.2	350.0	0.32	545
R56	0.56	±20%	40	25.2	325.0	0.36	520
R68	0.68	±20%	40	25.2	300.0	0.40	500
R82	0.82	±20%	40	25.2	275.0	0.45	475
1R0	1.0	±5%,±10%	50	7.96	250.0	0.50	450
1R2	1.2	±5%,±10%	50	7.96	240.0	0.55	430
1R5	1.5	±5%,±10%	50	7.96	210.0	0.60	410
1R8	1.8	±5%,±10%	50	7.96	190.0	0.65	390
2R2	2.2	±5%,±10%	50	7.96	160.0	0.70	380
2R7	2.7	±5%,±10%	50	7.96	150.0	0.75	370
3R3	3.3	±5%,±10%	50	7.96	110.0	0.80	355
3R9	3.9	±5%,±10%	50	7.96	100.0	0.90	330
4R7	4.7	±5%,±10%	50	7.96	80.0	1.00	315
5R6	5.6	±5%,±10%	50	7.96	50.0	1.10	300
6R8	6.8	±5%,±10%	50	7.96	35.0	1.20	285
8R2	8.2	±5%,±10%	50	7.96	28.0	1.40	270
100	10	±5%,±10%	50	2.52	22.0	1.60	250
120	12	±5%,±10%	50	2.52	20.0	2.00	225
150	15	±5%,±10%	50	2.52	18.0	2.50	200
180	18	±5%,±10%	50	2.52	16.0	2.80	190
220	22	±5%,±10%	50	2.52	14.0	3.20	180
270	27	±5%,±10%	50	2.52	13.0	3.60	170
330	33	±5%,±10%	50	2.52	12.0	4.00	160
390	39	±5%,±10%	50	2.52	11.0	4.50	150
470	47	±5%,±10%	50	2.52	10.5	5.00	140
560	56	±5%,±10%	50	2.52	10.0	5.50	135
680	68	±5%,±10%	50	2.52	9.5	6.00	130
820	82	±5%,±10%	50	2.52	8.5	7.00	120
101	100	±5%,±10%	40	0.796	8.0	8.00	110
121	120	±5%,±10%	40	0.796	7.0	8.00	110
151	150	±5%,±10%	40	0.796	6.0	9.00	105
181	180	±5%,±10%	40	0.796	5.5	9.50	102
221	220	±5%,±10%	40	0.796	5.0	10.0	100
271	270	±5%,±10%	40	0.796	4.5	12.0	92
331	330	±5%,±10%	40	0.796	4.0	14.0	85
391	390	±5%,±10%	40	0.796	3.5	18.0	80
471	470	±5%,±10%	40	0.796	3.5	26.0	62
561	560	±5%,±10%	30	0.796	3.0	30.0	50
681	680	±5%,±10%	30	0.796	3.0	30.0	50
821	820	±5%,±10%	30	0.796	2.5	35.0	30



**Wire Wound Chip Inductor (Ferrite)**

NL20 Wire Wound Chip Inductors (Ferrite / Molding Type) / Standard Type

Codes	Inductance (mH)	Tolerance	Test Freq. (MHz)	Q min.	SRF (MHz) min.	DCR (Ω) max.	IDC (mA) max.
122	1.2	±5, ±10%	0.252	20	1.5	17	75
152	1.5	±5, ±10%	0.252	20	1.4	20	70
182	1.8	±5, ±10%	0.252	20	1.3	30	60
222	2.2	±5, ±10%	0.252	20	1.2	35	55
272	2.7	±5, ±10%	0.252	20	1.1	55	45
332	3.3	±5, ±10%	0.252	20	1.0	60	40
392	3.9	±5, ±10%	0.252	20	1.0	70	38
472	4.7	±5, ±10%	0.252	20	0.9	78	36
562	5.6	±5, ±10%	0.252	20	0.8	85	33
682	6.8	±5, ±10%	0.252	20	0.7	110	30
822	8.2	±5, ±10%	0.252	20	0.6	125	28
103	10	±5, ±10%	0.0796	15	0.5	150	25

**Large Current Electrical Specifications**

NL03 Wound Chip Inductors (Ferrite / Open Type) / **Large Current Type**

Codes	Inductance (μH)	Tolerance	Q min.	Test Freq. (MHz)	SRF (MHz) min.	DCR (Ω) max.	IDC (mA) max.	Color Code
47N	0.047	±10%	12	7.9	2000	0.075	1800	White
51N	0.051	±10%	12	7.9	1500	0.075	1800	Violet
56N	0.056	±10%	7	7.9	1500	0.095	2200	Blue
68N	0.068	±10%	10	7.9	1500	0.12	2200	Gray
72N	0.072	±10%	12	7.9	1500	0.12	2200	Brown
R10	0.10	±10%	12	7.9	1150	0.13	2200	Black
R12	0.12	±5, ±10%	12	7.9	1100	0.15	1900	Orange
R15	0.15	±5, ±10%	15	7.9	1050	0.15	1800	Brown
R18	0.18	±5, ±10%	15	7.9	950	0.15	1800	Green
R22	0.22	±5, ±10%	15	7.9	900	0.30	1300	Red
R24	0.24	±5, ±10%	15	7.9	850	0.16	1700	Green
R27	0.27	±5, ±10%	15	7.9	835	0.30	1400	Yellow
R33	0.33	±5, ±10%	15	7.9	725	0.40	1300	Orange
R36	0.36	±5, ±10%	15	7.9	720	0.41	1300	Green
R39	0.39	±5, ±10%	15	7.9	680	0.41	1200	Blue
R47	0.47	±5, ±10%	15	7.9	640	0.43	1200	Black
R56	0.56	±5, ±10%	15	7.9	630	0.44	1200	Brown
R65	0.65	±5, ±10%	15	7.9	510	0.52	1000	Blue
R68	0.68	±5, ±10%	15	7.9	510	0.52	1000	Red
R78	0.78	±5, ±10%	15	7.9	465	0.63	990	Orange
R82	0.82	±5, ±10%	15	7.9	460	0.69	990	Yellow
R90	0.90	±5, ±10%	15	7.9	350	0.81	950	Black
1R0	1.0	±5, ±10%	15	7.9	320	0.81	850	Green
1R2	1.2	±5, ±10%	15	7.9	270	0.87	850	Blue
1R5	1.5	±5, ±10%	15	7.9	230	0.96	830	Violet
1R8	1.8	±5, ±10%	15	7.9	210	1.10	820	Gray
2R2	2.2	±5, ±10%	15	7.9	115	1.20	720	White
2R7	2.7	±5, ±10%	15	7.9	100	1.38	700	Black
3R0	3.0	±5, ±10%	15	7.9	90	1.45	680	Black
3R3	3.3	±5, ±10%	15	7.9	84	1.50	640	Brown
3R9	3.9	±5, ±10%	15	7.9	75	1.50	630	Red
4R7	4.7	±5, ±10%	15	7.9	67	2.10	530	Orange
5R6	5.6	±5, ±10%	15	7.9	55	2.37	510	Yellow
6R8	6.8	±5, ±10%	15	7.9	48	3.10	490	Green
7R8	7.8	±5, ±10%	15	7.9	40	3.35	420	Blue
8R2	8.2	±5, ±10%	15	7.9	38	3.50	450	Violet
100	10	±5, ±10%	15	7.9	32	4.46	370	Gray
150	15	±5, ±10%	14	7.9	25	9.50	240	White

NL05 Wire Wound Chip Inductors (Ferrite / Open Type) / **Large Current Type**

Codes	Inductance (μH)	Tolerance	Q typ.	Test Freq. (MHz)	SRF (MHz) typ.	DCR (Ω) max.	IDC (mA) max.	Color Code
R10	0.10	±10, ±20%	9	7.9	1700	0.091	2400	Black
R15	0.15	±10, ±20%	12	7.9	1500	0.104	1900	Brown
R22	0.22	±10, ±20%	12	7.9	1200	0.130	1700	Red
R33	0.33	±10, ±20%	12	7.9	900	0.156	1400	Orange
R47	0.47	±10, ±20%	14	7.9	850	0.156	1400	Blue
R56	0.56	±10, ±20%	14	7.9	360	0.195	1200	Violet
R68	0.68	±10, ±20%	14	7.9	290	0.195	1200	Gray
R82	0.82	±10, ±20%	14	7.9	208	0.195	1100	White
1R0	1.00	±10, ±20%	14	7.9	208	0.169	1100	Black
1R2	1.20	±10, ±20%	14	7.9	159	0.208	960	Red
1R5	1.50	±10, ±20%	14	7.9	159	0.221	920	Brown
1R8	1.80	±10, ±20%	14	7.9	112	0.260	860	Orange
2R2	2.20	±10, ±20%	13	7.9	87	0.286	740	Red
2R7	2.70	±10, ±20%	13	7.9	72	0.325	680	Yellow
3R3	3.30	±10, ±20%	12	7.9	70	0.364	620	Orange
3R9	3.90	±10, ±20%	14	7.9	61	0.494	580	Green
4R7	4.70	±10, ±20%	14	7.9	51	0.559	520	Yellow
5R6	5.60	±10, ±20%	12	7.9	47	0.650	480	Blue
6R8	6.80	±10, ±20%	14	7.9	46	0.884	420	Green
8R2	8.20	±10, ±20%	13	7.9	33	0.949	400	Violet
100	10	±5, ±10, ±20%	14	2.5	31	1.105	360	Blue
120	12	±5, ±10, ±20%	14	2.5	30	1.17	340	Gray
150	15	±5, ±10, ±20%	15	2.5	28	1.82	300	Violet
180	18	±5, ±10, ±20%	15	2.5	27	2.01	280	White
220	22	±5, ±10, ±20%	15	2.5	20	2.288	240	Gray
270	27	±5, ±10, ±20%	15	2.5	17	2.60	220	Black
330	33	±5, ±10, ±20%	15	2.5	17	3.055	200	White
390	39	±5, ±10, ±20%	14	2.5	15	4.355	180	Brown
470	47	±5, ±10, ±20%	14	2.5	15	4.42	160	Black
560	56	±5, ±10, ±20%	14	2.5	10	5.746	150	Yellow
680	68	±5, ±10, ±20%	14	2.5	10	5.785	140	Brown
820	82	±5, ±10, ±20%	14	2.5	10	9.75	100	Orange
101	100	±5, ±10, ±20%	10	1	9	9.75	100	Red
221	220	±5, ±10, ±20%	8	1	4	30.03	70	Blue

NL08 Wound Chip Inductors (Ferrite / Open Type) / **Large Current Type**

Codes	Inductance (µH)	Tolerance	Q typ.	Test Freq. (MHz)	SRF (MHz) min.	DCR (Ω) max.	IDC (mA) max.	Color Code		
								1st	2nd	3rd
78N	0.078	±5, ±10%	19	7.9	1000	0.042	3200	Black	Violet	Gray
R10	0.10	±5, ±10%	35	25	1500	0.05	3200	Brown	Red	Brown
R22	0.22	±5, ±10%	35	25	800	0.15	2900	Red	Red	Brown
R39	0.39	±5, ±10%	35	25	460	0.20	2100	Orange	White	Brown
R47	0.47	±10%	35	25	460	0.20	2100	Yellow	Violet	Brown
R56	0.56	±5, ±10%	35	25	360	0.26	1800	Green	Blue	Brown
R68	0.68	±5, ±10%	35	25	400	0.30	1700	Blue	Gray	Brown
R82	0.82	±5, ±10%	35	25	360	0.35	1400	Gray	Red	Brown
1R0	1.0	±10%	32	7.9	340	0.34	1700	Brown	Black	Red
1R1	1.1	±10%	25	7.9	300	0.34	1500	Brown	Brown	Red
1R2	1.2	±5, ±10%	25	7.9	300	0.25	1600	Brown	Red	Red
1R5	1.5	±5, ±10%	32	7.9	230	0.42	1200	Brown	Green	Red
1R8	1.8	±5, ±10%	27	7.9	180	0.45	1100	Brown	Gray	Red
2R2	2.2	±5, ±10%	27	7.9	140	0.50	1100	Red	Red	Red
2R7	2.7	±5, ±10%	27	7.9	130	0.55	1000	Red	Violet	Red
3R3	3.3	±5, ±10%	27	7.9	125	0.60	1000	Orange	Orange	Red
3R9	3.9	±5, ±10%	27	7.9	100	0.80	990	Orange	White	Red
4R7	4.7	±5, ±10%	30	7.9	90	0.90	880	Yellow	Violet	Red
5R6	5.6	±5, ±10%	27	7.9	60	1.00	850	Green	Blue	Red
6R8	6.8	±5, ±10%	27	7.9	60	1.05	840	Blue	Gray	Red
8R2	8.2	±5, ±10%	25	7.9	55	1.20	810	Gray	Red	Red
100	10	±5, ±10%	23	2.5	55	1.55	700	Brown	Black	Orange
120	12	±5, ±10%	23	2.5	36	2.10	580	Brown	Red	Orange
150	15	±5, ±10%	23	2.5	36	2.38	580	Brown	Green	Orange
180	18	±5, ±10%	23	2.5	32	2.50	520	Brown	Gray	Orange
220	22	±5, ±10%	23	2.5	29	2.92	500	Red	Red	Orange
270	27	±10%	23	2.5	22	3.70	450	Red	Violet	Orange
330	33	±5, ±10%	23	2.5	21	4.10	420	Orange	Orange	Orange
390	39	±5, ±10%	18	2.5	15	5.50	340	Orange	White	Orange
470	47	±5, ±10%	23	2.5	17	7.80	310	Yellow	Violet	Orange
680	68	±5, ±10%	20	2.5	9	11.5	220	Blue	Gray	Orange
101	100	±5, ±10%	13	1	4	13.2	210	Brown	Black	Yellow
151	150	±5, ±10%	13	1	3	22.5	170	Brown	Green	Yellow
221	220	±5, ±10%	13	1	3	26.5	160	Red	Red	Yellow
271	270	±5, ±10%	13	1	2	32.0	135	Red	Violet	Yellow
331	330	±5, ±10%	13	1	2	32.5	130	Orange	Orange	Yellow

NL10 Wire Wound Chip Inductors (Ferrite / Molding Type) / **Large Current Type**

Codes	Inductance (µH)	Tolerance	Q min.	Test Freq. (MHz)	SRF (MHz) typ.	DCR (Ω) max.	IDC (mA) max.
1R0	1.0	±5%,±20%	10	7.96	145	0.156	770
1R5	1.5	±5%,±20%	10	7.96	100	0.195	580
2R2	2.2	±5%,±20%	10	7.96	80	0.260	480
3R3	3.3	±5%,±20%	10	7.96	60	0.325	400
4R7	4.7	±5%,±20%	10	7.96	50	0.520	320
6R8	6.8	±5%,±20%	10	7.96	40	0.650	280
100	10	±5%,±10%	15	2.52	30	1.105	220
150	15	±5%,±10%	15	2.52	27	1.690	180
220	22	±5%,±10%	15	2.52	22	2.600	145
270	27	±5%,±10%	15	2.52	19	3.000	125
330	33	±5%,±10%	15	2.52	17	3.640	115
470	47	±5%,±10%	20	2.52	15	5.460	105
680	68	±5%,±10%	20	2.52	11	8.450	85
820	82	±5%,±10%	20	2.52	10	8.710	80
101	100	±5%,±10%	20	0.796	9	10.140	75

Codes	Inductance (μH)	Tolerance	Q min.	Test Freq. (MHz)	SRF (MHz) typ.	DCR (Ω) max.	IDC (mA) max.
1R0	1.0	±5%,±10%	10	7.96	265	0.11	1050
1R2	1.2	±5%,±10%	10	7.96	180	0.12	1000
1R5	1.5	±5%,±10%	10	7.96	170	0.15	950
1R8	1.8	±5%,±10%	10	7.96	105	0.16	900
2R2	2.2	±5%,±10%	10	7.96	80	0.18	850
2R7	2.7	±5%,±10%	10	7.96	60	0.20	800
3R3	3.3	±5%,±10%	10	7.96	55	0.22	750
3R9	3.9	±5%,±10%	10	7.96	45	0.24	700
4R7	4.7	±5%,±10%	10	7.96	43	0.27	650
5R6	5.6	±5%,±10%	10	7.96	40	0.30	650
6R8	6.8	±5%,±10%	10	7.96	35	0.35	600
8R2	8.2	±5%,±10%	10	7.96	30	0.40	600
100	10	±5%,±10%	10	2.52	27	0.50	550
120	12	±5%,±10%	10	2.52	25	0.60	500
150	15	±5%,±10%	10	2.52	20	0.70	450
180	18	±5%,±10%	10	2.52	19	0.80	400
220	22	±5%,±10%	10	2.52	18	0.90	370
270	27	±5%,±10%	10	2.52	16	1.20	330
330	33	±5%,±10%	10	2.52	15	1.40	300
390	39	±5%,±10%	10	2.52	13	1.60	280
470	47	±5%,±10%	10	2.52	12	1.90	260
560	56	±5%,±10%	10	2.52	10	2.20	240
680	68	±5%,±10%	10	2.52	9.5	2.60	220
820	82	±5%,±10%	10	2.52	8.5	3.50	200
101	100	±5%,±10%	20	0.796	8.0	4.00	180
121	120	±5%,±10%	20	0.796	7.0	4.50	160
151	150	±5%,±10%	20	0.796	6.5	6.50	140
181	180	±5%,±10%	20	0.796	6.0	7.50	120
221	220	±5%,±10%	20	0.796	5.5	9.00	120
271	270	±5%,±10%	20	0.796	5.0	11.0	100
331	330	±5%,±10%	20	0.796	4.5	13.0	90
391	390	±5%,±10%	20	0.796	4.0	14.0	85
471	470	±5%,±10%	20	0.796	3.5	16.0	75
561	560	±5%,±10%	20	0.796	3.0	21.0	70
681	680	±5%,±10%	20	0.796	2.5	24.0	65



NL20 Wire Wound Chip Inductors (Ferrite / Molding Type) / **Large Current Type**

Codes	Inductance (μH)	Tolerance	Q min.	Test Freq. (MHz)	SRF (MHz) min.	DCR (Ω) max.	IDC (mA) max.
1R0	1.0	±10, ±20%	10	7.96	95	0.03	1800
1R2	1.2	±10, ±20%	10	7.96	70	0.035	1700
1R5	1.5	±10, ±20%	10	7.96	55	0.04	1600
1R8	1.8	±10, ±20%	10	7.96	47	0.05	1400
2R2	2.2	±10, ±20%	10	7.96	42	0.06	1300
2R7	2.7	±10, ±20%	10	7.96	37	0.07	1200
3R3	3.3	±10, ±20%	10	7.96	34	0.08	1120
3R9	3.9	±10, ±20%	10	7.96	32	0.09	1050
4R7	4.7	±10, ±20%	10	7.96	29	0.11	950
5R6	5.6	±10, ±20%	10	7.96	26	0.13	880
6R8	6.8	±10, ±20%	10	7.96	24	0.15	810
8R2	8.2	±10, ±20%	10	7.96	22	0.18	750
100	10	±10, ±20%	10	2.52	19	0.21	690
120	12	±10, ±20%	10	2.52	17	0.25	630
150	15	±10, ±20%	10	2.52	16	0.30	580
180	18	±10, ±20%	10	2.52	14	0.36	530
220	22	±5, ±10%	10	2.52	13	0.43	480
270	27	±5, ±10%	10	2.52	11.5	0.52	440
330	33	±5, ±10%	10	2.52	10.5	0.62	400
390	39	±5, ±10%	10	2.52	9.5	0.72	370
470	47	±5, ±10%	10	2.52	8.5	0.85	340
560	56	±5, ±10%	10	2.52	7.8	1.00	310
680	68	±5, ±10%	10	2.52	7.0	1.2	290
820	82	±5, ±10%	10	2.52	6.4	1.4	270
101	100	±5, ±10%	20	0.796	6.0	1.6	250
121	120	±5, ±10%	20	0.796	5.4	1.9	230
151	150	±5, ±10%	20	0.796	4.8	2.2	210
181	180	±5, ±10%	20	0.796	4.4	2.8	190
221	220	±5, ±10%	20	0.796	3.9	3.4	170
271	270	±5, ±10%	20	0.796	3.6	4.2	155
331	330	±5, ±10%	20	0.796	3.2	4.9	140
391	390	±5, ±10%	20	0.796	2.9	5.8	130
471	470	±5, ±10%	20	0.796	2.6	7.0	120
561	560	±5, ±10%	20	0.796	2.4	8.5	110
681	680	±5, ±10%	20	0.796	2.2	10	100
821	820	±5, ±10%	20	0.796	2.0	13	90
102	1000	±5, ±10%	20	0.252	1.8	15	85

**Environmental Characteristics**

Electrical Performance Test

Item	Requirement	Test Method
Inductance	Refer to standard electrical characteristic spec.	HP4291 or HP4284
Q		HP4291 or HP4284
SRF		HP4291
DC Resistance DCR		Agilent 34401A
Rated Current IDC		Applied the current to coils, The inductance change should be less than 10% to initial value

Mechanical Performance Test

Item	Requirement	Test Method
Solderability	The electrodes shall be at least 90% covered with new solder coating	Lead-free inductor: after fluxing(alpha 100 or equiv), inductor shall be dipped in a melted solder bath at 245±5°C, 5±0.5 seconds
Resistance to Soldering Heat	Appearance: No damage	Pre-heating: 150°C, 1min. Solder Temperature: 260±5°C Immersion Time: 10±1 seconds
Vibration	Appearance: No damage L change: within±10% Q change: within±30% DCR: within specification	Test device shall be soldered on the substrate Oscillation Frequency: 10 to 55 to 10Hz for 1 min. Amplitude: 1.5 mm Time: 2 hrs for each axis (X, Y&Z), total 6 hrs

Climatic Test

Item	Requirement	Test Method															
Temperature Cycle	Appearance: No damage L change: within±10% Q change: within±30% DCR: within specification	One cycle: <table border="1"> <thead> <tr> <th>Step</th> <th>Temperature (°C)</th> <th>Time (min.)</th> </tr> </thead> <tbody> <tr> <td>1</td> <td>-25±3</td> <td>30</td> </tr> <tr> <td>2</td> <td>25±2</td> <td>3</td> </tr> <tr> <td>3</td> <td>85±3</td> <td>30</td> </tr> <tr> <td>4</td> <td>25±2</td> <td>3</td> </tr> </tbody> </table>	Step	Temperature (°C)	Time (min.)	1	-25±3	30	2	25±2	3	3	85±3	30	4	25±2	3
Step		Temperature (°C)	Time (min.)														
1		-25±3	30														
2		25±2	3														
3		85±3	30														
4	25±2	3															
Damp Heat with Load	Total: 100 cycles Measured after exposure in the room condition for 24 hrs																
High Temperature Storage	Temperature: 40±2°C Relative Humidity: 90 ~ 95% Time: 1000 hrs Measured after exposure in the room condition for 24 hrs																
Low Temperature Storage	Temperature: 85±3°C Applied Current: Rated Current Time: 1000 hrs Measured after exposure in the room condition for 24 hrs																
	Temperature: -25±3°C Time: 1000 hrs Measured after exposure in the room condition for 24 hrs																

■ **Storage Temperature: 23±15°C; Humidity < 80%RH**

■ **Operating Temperature Range: -40~+85°C**

**■Packaging**

Packaging Quantity & Reel Specifications

Type	ΦA	ΦB	ΦC	W	T	Quantity (EA)
NL02	178±2.0	60±0.5	13±0.3	9±0.3	12±1.0	4000
NL03	178±2.0	60±0.5	13±0.3	9±0.3	12±1.0	4000
NL05	178±2.0	60±0.5	13±0.3	9±0.3	12±1.0	2000
NL08	178±2.0	60±0.5	13±0.3	9±0.3	12±1.0	2000
NL10	178±2.0	60±0.5	13±0.3	9±0.3	12±1.0	2000
NL12	178±2.0	80±0.5	13±0.3	13.2±0.3	16±1.0	500
NL20	330±2.0	100±0.5	13±0.3	17.4±0.3	22±1.0	1000

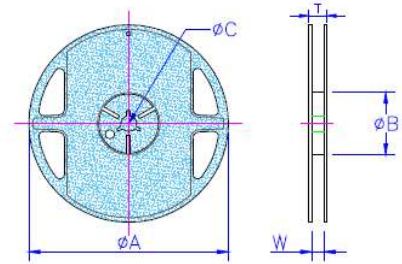

Paper Tape specifications

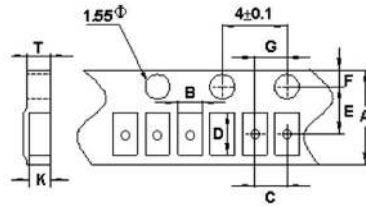

Type	A (mm)	B (mm)	C (mm)	D (mm)	E (mm)	F (mm)	G (mm)	T (mm)	K (mm)
NL02	8.0	0.67	2	1.20	3.5	1.75	2	0.75	0.59

Embossed Plastic Tape Specifications

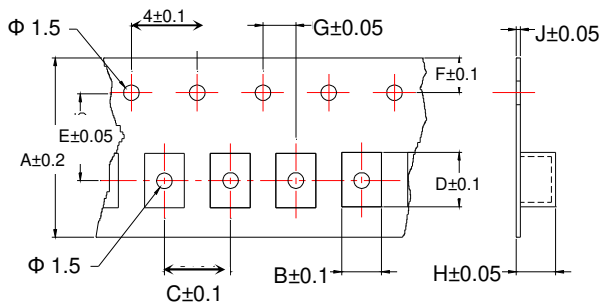

Type	A mm	B mm	C mm	D mm	E mm	F mm	G mm	H mm	J mm
NL03	8	1.25	4	1.90	3.5	1.75	2	1.00	0.23
NL05	8	1.85	4	2.55	3.5	1.75	2	1.45	0.23
NL08	8	2.80	4	2.95	3.5	1.75	2	2.22	0.23
NL10	8	2.96	4	3.60	3.5	1.75	2	2.40	0.23
NL12	12	3.30	8	5.00	5.5	1.75	2	3.50	0.30
NL20	16	5.35	12	6.10	7.5	1.75	2	5.50	0.35