



IO-Link to PROFINET and Modbus TCP gateway

User manual

UM EN IOL MA8 PN DI8

User manual

IO-Link to PROFINET and Modbus TCP gateway

UM EN IOL MA8 PN DI8, Revision A

2019-03-08

This user manual is valid for:

Designation

IOL MA8 PN DI8

Order No.

1072838

Table of contents

1	For your safety	3
1.1	Labeling of warning notes	3
1.2	Qualification of users	3
1.3	Field of application of the product	4
1.3.1	Intended use	4
1.3.2	Foreseeable misuse	4
1.3.3	Product changes	4
1.4	Acknowledgments	4
2	Description.....	5
2.1	Overview	5
2.2	Structure	5
2.3	System example	6
3	Installation	7
3.1	Mounting	7
3.2	Data interfaces	8
3.2.1	Connecting the Ethernet cable	8
3.3	Connecting the power supply	9
3.4	Connecting devices to IOL MA8 PN DI8 ports	10
4	Configuration and startup.....	13
4.1	Default settings.....	13
4.2	Web-based management	13
4.2.1	Login	14
4.2.2	Home page	15
4.2.3	Selecting a language	15
5	Web manager interface	17
5.1	Diagnostics.....	17
5.1.1	IO-Link diagnostics	19
5.1.2	PROFINET IO diagnostics	22
5.1.3	Modbus TCP diagnostics	25
5.1.4	OPC UA diagnostics	28

5.2	Configuration	28
5.2.1	Preparing for port configuration	28
5.2.2	IO-Link configuration	31
5.2.3	PROFINET IO configuration	39
5.2.4	Modbus TCP configuration	40
5.2.5	OPC UA configuration	45
5.2.6	LAN settings	47
5.2.7	Utilities	48
5.2.8	Configuration files	51
5.3	Device maintenance	53
5.3.1	Firmware	53
5.3.2	Accounts	55
5.3.3	Log files	57
5.3.4	Device snapshot	59
5.4	Attached devices	60
5.4.1	IODD files	60
5.4.2	IO-Link device configuration summary	62
5.4.3	Port parameters	64
6	Troubleshooting	71
6.1	Troubleshooting	71
6.2	Status LEDs	72
A	Technical appendix	75
A 1	Modbus TCP interface	75
A 2	Modbus TCP address definitions	76
B	Appendixes	77
B 1	List of figures	77
B 2	List of tables	79

1 For your safety

Read this user manual carefully and keep it to hand for future reference.

The applicable specifications and safety directives (including the national safety directives), as well as the general technical regulations, must be observed during installation and operation. The technical data should be taken from the packaging instructions and the certificates (conformity assessment, other possible approvals).

The IP20 degree of protection (EN 60529) of the device is intended for a clean and dry environment.

Do not subject the device to any load that exceeds the prescribed limits.

The device is not designed for use in environments with danger of dust explosions.

1.1 Labeling of warning notes



This symbol indicates hazards that could lead to personal injury. There are three signal words indicating the severity of a potential injury.

DANGER

Indicates a hazard with a high risk level. If this hazardous situation is not avoided, it will result in death or serious injury.

WARNING

Indicates a hazard with a medium risk level. If this hazardous situation is not avoided, it could result in death or serious injury.

CAUTION

Indicates a hazard with a low risk level. If this hazardous situation is not avoided, it could result in minor or moderate injury.



This symbol together with the **NOTE** signal word alerts the reader to a situation which may cause damage or malfunction to the device, hardware/software, or surrounding property.



Find find additional information or detailed sources of information.

1.2 Qualification of users

The use of products described in this user manual is oriented exclusively to:

- Qualified electricians or persons instructed by them. The users must be familiar with the relevant safety concepts of automation technology as well as applicable standards and other regulations.
- Qualified application programmers and software engineers. The users must be familiar with the relevant safety concepts of automation technology as well as applicable standards and other regulations.

1.3 Field of application of the product

1.3.1 Intended use

The IOL MA8 PN D18 protocol converter provides convenient access to configure IO-Link devices using web-based management. Sensor status may be monitored using PROFINET, Modbus TCP, and OPC UA.

1.3.2 Foreseeable misuse

Phoenix Contact is not responsible for the logic within the device or any application that was created using this product or devices described within this document.

1.3.3 Product changes

Changes or modifications to hardware and software of the device are not permitted.

Incorrect operation or modifications to the device can endanger safety or damage the device. Do not repair the device yourself.

Opening the device or making changes to it is not permitted. Do not repair the device yourself, but replace it with an equivalent device. Repairs may be carried out only by the manufacturer. The manufacturer is not liable for any damage caused by violation of the prescribed regulations.

If the device is defective, please contact Phoenix Contact.

1.4 Acknowledgments

The developers of this product would like to thank the following open-source projects whose work is used under the listed licenses.

Table 1-1 Open-source licenses

Software	License	Software	License
Linux kernel	GPLv2	buildroot	GPLv2
Busybox	GPLv2	file	file
gdbserver	GPLv3	json-c	json-c
ipkg	GPLv2	libpcap	BSD-libpcap
lighttpd	BSD-lighttpd	lsof	lsof
mtd	GPLv2	nano	GPLv3
net-snmp	net-snmp	openssh	BSD-openssh
openssl	BSD-openssl	pcrc	PSD-pcre
php	php	strace	BSD-strace
zlib	BSD-zlib	Open62541	Mozilla public license

2 Description

2.1 Overview

The IOL MA8 PN DI8 provides the ability to configure up to eight IO-Link sensors using web-based management and seamlessly integrates your IO-Link devices into your control system using Modbus TCP, PROFINET, and OPC UA.

2.2 Structure

The IOL MA8 PN DI8 features two Ethernet ports, status LEDs, and connectors for power and IO-Link ports.

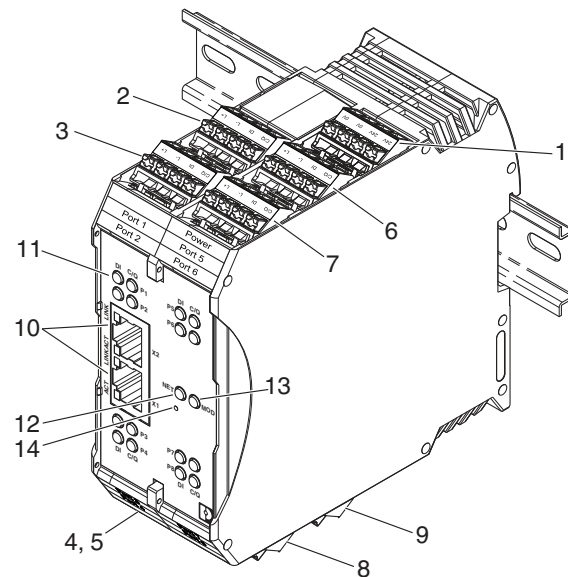

Figure 2-1 IOL MA8 PN DI8 structure

Table 2-1 IOL MA8 PN DI8 structure

Item	Description
1	Power connector
2	Port 1 IO-Link connector
3	Port 2 IO-Link connector
4	Port 3 IO-Link connector
5	Port 4 IO-Link connector
6	Port 5 IO-Link connector
7	Port 6 IO-Link connector
8	Port 7 IO-Link connector
9	Port 8 IO-Link connector

Table 2-1 IOL MA8 PN DI8 structure

Item	Description
10	Ethernet ports (RJ45)
11	Digital input and IO-Link port status LEDs
12	NET status LED
13	MOD status LED
14	Reset button

2.3 System example

The following diagram illustrates the IOL MA8 PN DI8 in a system configuration.

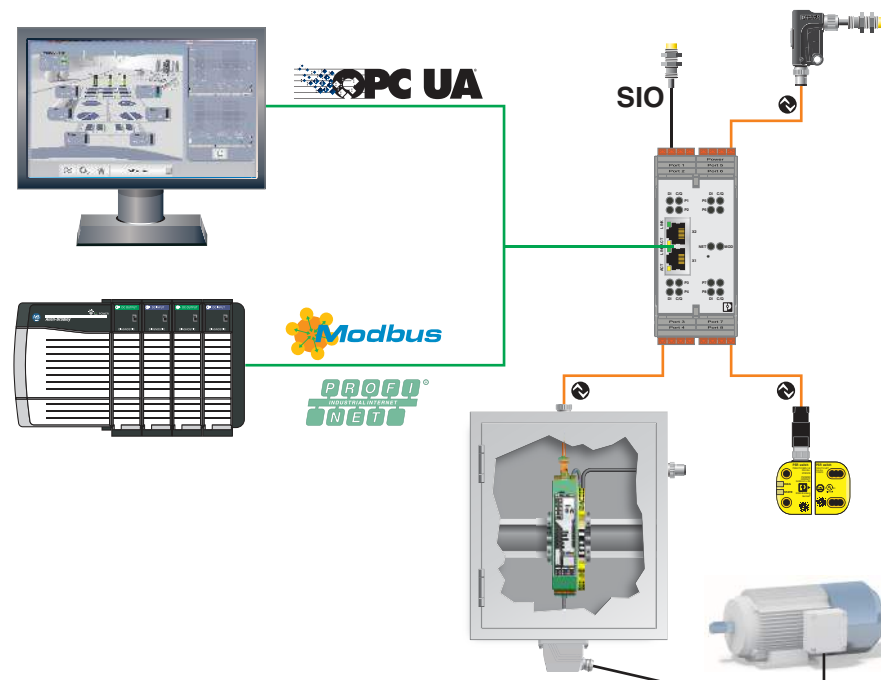

Figure 2-2 Typical system overview

3 Installation

3.1 Mounting

To mount on the DIN rail:

1. Place the device on to the DIN rail from above (1), so that the upper housing keyway hooks on to the top edge of the DIN rail.
2. Hold the device by the housing cover and carefully push the device toward the mounting surface (2).
3. After the foot is snapped on to the DIN rail, verify that it is attached securely.

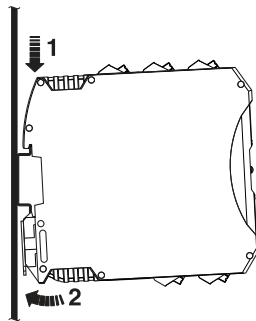

Figure 3-1 DIN rail mounting

To remove:

1. Use a suitable screwdriver to release the locking mechanism (1) on the snap-on foot of the device.
2. Hold on to the device by the housing cover and carefully tilt it upward (2).
3. Remove the device from the DIN rail (3).

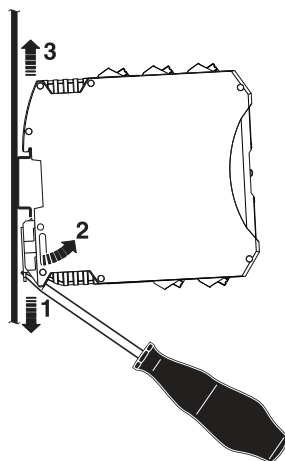

Figure 3-2 DIN rail removal

3.2 Data interfaces

3.2.1 Connecting the Ethernet cable

The IOL MA8 PN D18 has an Ethernet interface on the front in RJ45 format, to which only twisted-pair cables with an impedance of 100 Ω can be connected. The data transmission rate is either 10 or 100 Mbps. The IOL MA8 PN D18 supports the auto negotiation function for automatic selection of the transmission speed, as well as an automatic crossover feature for the automatic selection of line or crossover cabling.

Push the Ethernet cable with the crimped RJ45 connector into the IOL MA8 PN D18 until it engages with a click.

The IOL MA8 PN D18 Ethernet interface is classified as a switch. The maximum number of daisy-chained IOL MA8 PN D18 units, and the maximum distance between units, is based on the Ethernet standards and is determined by the environment and conformity of the network to these standards. There may be some performance degradation on the devices at the end of the chain, so it is recommended to overload and test for performance in the environment. The application may also limit the total number of ports that may be installed. Some basic guidelines are listed below.

- Ethernet 10Base-T rules
 - The maximum number of repeater segments is four.
 - Use Category 3 or 5 twisted-pair 10Base-T cables. The maximum length of each cable is 100 m.
- Fast Ethernet 100Base-TX rules
 - The maximum number of repeater segments is two (for a Class II hub). A Class II hub can be connected directly to one other Class II Fast Ethernet hub. A Class I hub cannot be connected directly to another Fast Ethernet hub.
 - CAT5 or greater twisted-pair cable must be used. The maximum length of each twisted-pair cable is 100 m.
 - The total length of twisted-pair cabling (across directly connected hubs) must not exceed 205 m.
- IEEE 802.3 specification: A network using repeaters between communicating stations (PCs) is subject to the 5-4-3 rule of repeater placement on the network:
 - Five segments connected on the network.
 - Four repeaters.
 - Three segments of the fiber segments can have stations connected. The other two segments must be inter-repeater link segments with no stations connected.

3.3 Connecting the power supply

CAUTION:

Incorrect connection may result in damage to equipment and/or serious personal injury.

Only qualified personnel may connect the power, start up, and operate this device. According to the safety instructions in this text, qualified personnel are persons who are authorized to start up, to ground, and to mark devices, systems, and equipment according to the standards of safety technology. In addition, these persons must be familiar with all warning instructions and maintenance measures in this text.

Disregarding this warning may result in damage to equipment and/or serious personal injury.

The device can be connected to a single power source or two power sources for redundancy. The IOL MA8 PN DI8 is powered using a +24 V DC SELV power supply. The power supply is connected by way of push-in terminal blocks (24 V and 0 V).

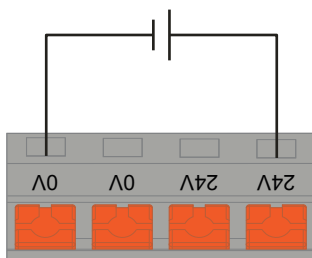

Figure 3-3 Single power supply connection

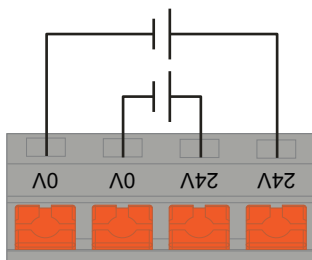

Figure 3-4 Redundant power supply connection

3.4 Connecting devices to IOL MA8 PN DI8 ports

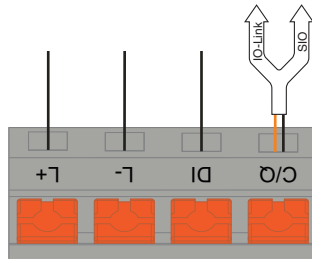

Figure 3-5 SIO connection

The following provides information about the power supply ports.

Table 3-1 Power supply port connections

Label	Signal	Description	Value
1	L+	Power supply output (+)	200 mA @ 24 V (Maximum)
2	L-	Power supply output (-)	
3	DI	Digital input	Not applicable
4	C/Q	Communication signal, which supports SDCI (IO-Link) or SIO (standard input/output)	200 mA @ 24 V (Maximum)



It may be useful to remove the plug-in terminal block from the IOL MA8 PN DI8 to aid in wire termination.

Connecting IO-Link devices

Use the following procedure to connect IO-Link devices to an IO-Link port.

1. Insert the IO-Link device negative wire into the L- position until the wire is fully secure.
2. Insert the IO-Link device positive wire into the L+ position until the wire is fully secure.
3. If applicable, insert the digital input signal wire into the DI position until the wire is fully secure.
4. Insert the IO-Link wire into the C/Q position until the wire is fully secure.
5. If necessary, configure IO-Link parameters for each port.

Connecting digital input devices to IOL MA8 PN DI8 ports

Use the following procedure to connect a digital input device to an IO-Link port.

1. Insert the IO-Link device negative wire into the L- position until the wire is fully secure.
2. Insert the IO-Link device positive wire into the L+ position until the wire is fully secure.
3. Insert the digital input signal wire into the DI position until the wire is fully secure.

Connecting digital input or output devices to IOL MA8 PN DI8 ports

Use the following procedure to connect and operate a digital input or output device.

1. Insert the IO-Link device negative wire into the L- position until the wire is fully secure.
2. Insert the IO-Link device positive wire into the L+ position until the wire is fully secure.
3. If applicable, insert the digital input or output signal wire into the C/Q position until the wire is fully secure.

4 Configuration and startup

4.1 Default settings

The default network settings of the IOL MA8 PN DI8 are:

IP address: 192.168.254.254

Subnet mask: 255.255.255.0

Gateway: 0.0.0.0



The default settings are invoked whenever the system is reset.

4.2 Web-based management

The user-friendly, web-based graphical user interface (GUI) allows management of the IOL MA8 PN DI8 from anywhere in the network using a standard browser. Comprehensive configuration and diagnostic functions, including a wide range of information about the device itself, current parameters, and operating state, are clearly displayed.

Terminology for the GUI is shown below.

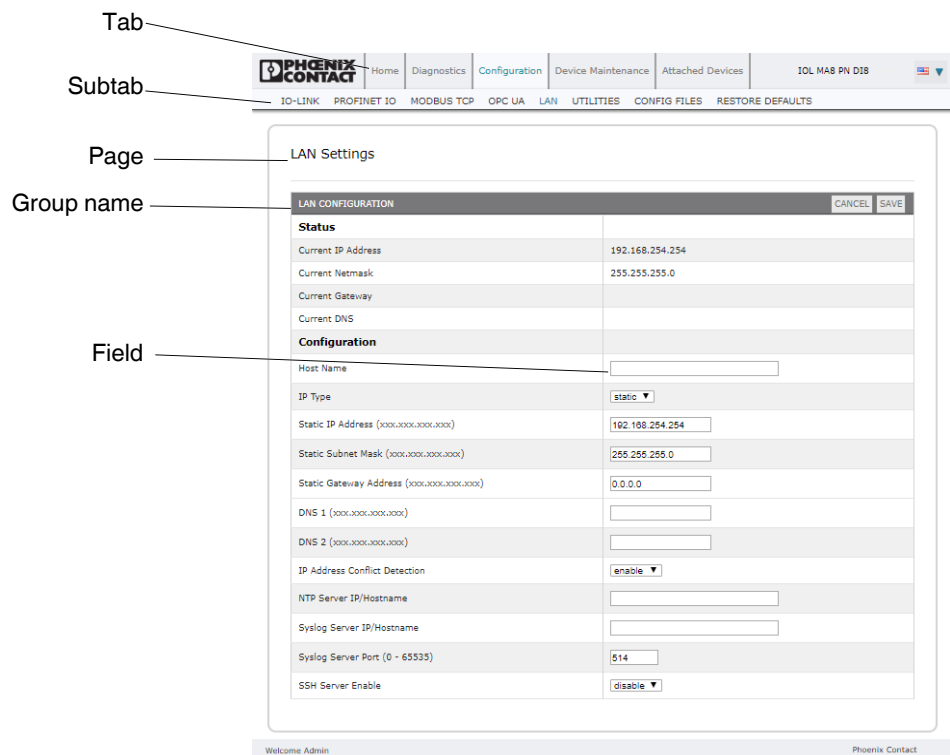

Figure 4-1 GUI terminology

4.2.1 Login

To log in:

1. Set the IP address of the connected PC to the subnetwork of the IOL MA8 PN D18. For example:
IP = 192.168.254.10
Subnetwork = 255.255.255.0
2. Open a browser and enter the IP address of the IOL MA8 PN D18 in the “Address” field (default = 192.168.254.254).

Figure 4-2 “Login” screen

The web server responds immediately.



If the web server does not load, first check the IP parameters of the PC. If everything is set correctly, check to see if there are any proxy settings loaded in the browser. The proxy setting must be set to “Load automatically” or “Deactivated” to properly establish communication.

3. By default, a user name and password are not required. If user accounts have been configured (see [“Accounts” on page 55](#)), enter the appropriate values in the corresponding fields to log in.



Powering multiple devices with factory default IP addresses causes a network conflict, and incorrect parameters may be set in the IOL MA8 PN D18 modules. When programming modules for the first time, it is important to apply power to only one at a time, and change the IP address of each module to a unique IP address. Once all devices have a unique IP address, they can be powered on together while on the same network.

4. Complete the IOL MA8 PN D18 configuration as necessary for the application.
 - Set the IP address (see [“LAN settings” on page 47](#)).
 - Load the appropriate IODD files (see [“IODD files” on page 60](#)).
 - Configure the IO-Link ports (see [“IO-Link configuration” on page 31](#)).

4.2.2 Home page

The “Home” page displays general system information.

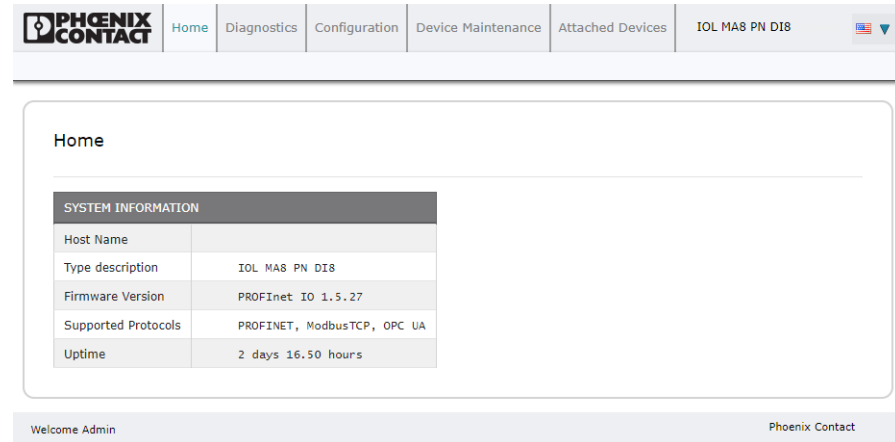

Figure 4-3 “Home” page

4.2.3 Selecting a language

Click the “Flag” icon to select the interface language, either English or German.

5 Web manager interface

5.1 Diagnostics

This chapter provides information about the diagnostics pages.

To access the diagnostics pages:

1. If necessary, log in to the IOL MA8 PN D18.
2. Click the “Diagnostics” tab, and then click the desired subtab. For example, to show the “IO-Link Diagnostics” page, click the “IO-Link” subtab.

The screenshot shows the Phoenix Contact web interface for the IOL MA8 PN D18. The top navigation bar includes 'Home', 'Diagnostics', 'Configuration', 'Device Maintenance', and 'Attached Devices'. Below this is a sub-menu with 'IO-LINK', 'PROFINET IO', 'MODBUS TCP', and 'OPC UA'. The main content area is titled 'IO-Link Diagnostics' and features a 'STOP LIVE UPDATES' button and a 'RESET STATISTICS' button. A table displays the following data:

IO-LINK PORT STATUS	PORT 1						
Port Name	IOLink Port 1						
Port Mode	IOLink						
Port Status	Operational, PDI Valid						
IOLink State	Operate						
Device Vendor Name	Phoenix Contact						
Device Product Name	ELR H5-IES-PT/500AC-3-IOL						
Device Serial Number	1358238023						
Device Hardware Version	1						
Device Firmware Version	1.10/1.11						
Device IO-Link Version	1.1						
Actual Cycle Time	30.0ms						
Device Minimum Cycle Time	30.0ms						
Configured Minimum Cycle Time	4ms						
Data Storage Capable	Yes						
Automatic Data Storage Configuration	Disabled						
Auxiliary Input (AI) Bit Status	Off						
Device PDI Data Length	8						
PDI Data Valid	Yes						
Last Rx PDI Data (MS Byte First)	00 00 00 00 00 00 00 01						
PDO Lock Enable	Yes						
PDO Locked	No						
Device PDO Data Length	2						
PDO Data Valid	No						
Last Tx PDO Data (MS Byte First)	00 00						
Time Since Initialization	2d 16:36:16						
Process Data Errors	0						
Process Data Retries	0						
Total Events	2						
First Events	1)Single,Message,Local,0024h_m_preoperate 2)Cleared,Error,Local,0010h_s_devicelost						
Last Events	1)Single,Message,Local,0024h_m_preoperate 2)Cleared,Error,Local,0010h_s_devicelost						
ISDU Statistics							
ISDU Read Cmd Attempts	18						
ISDU Read Cmd Errors	0						
ISDU Write Cmd Attempts	0						
ISDU Write Cmd Errors	0						

The footer of the page shows 'Welcome Admin' on the left and 'Phoenix Contact' on the right.

Figure 5-1 “IO-Link Diagnostics” page

3. Use the scroll bars to view all available information.
4. This data is updated with the “LIVE update” function providing constant updates. If desired, click the “STOP LIVE UPDATES” button to stop the function. To update data immediately, click the “UPDATE” button. Click the “RESET STATISTICS” button to reset the statistics fields.

5.1.1 IO-Link diagnostics

Use the “IO-Link Diagnostics” page to determine the status of the IO-Link configuration.

The screenshot shows the 'IO-Link Diagnostics' page with a navigation bar at the top containing 'Home', 'Diagnostics', 'Configuration', 'Device Maintenance', and 'Attached Devices'. The main content area features a table with columns for PORT 1 through PORT 8. The table includes various status indicators and configuration parameters for each port. At the top right of the table area, there are buttons for 'UPDATE', 'START LIVE UPDATES', and 'RESET STATISTICS'. Below the table, there are 'Welcome Admin' and 'Phoenix Contact' labels.

IO-LINK PORT STATUS	PORT 1	PORT 2	PORT 3	PORT 4	PORT 5	PORT 6	PORT 7	PORT 8
Port Name	IOLink Port 1	IOLink Port 2	IOLink Port 3	IOLink Port 4	IOLink Port 5	IOLink Port 6	IOLink Port 7	IO-Link Port 8
Port Mode	IOLink	IOLink	IOLink	IOLink	IOLink	IOLink	IOLink	IOLink
Port Status	Operational, PDI Valid	Operational, PDI Valid	Operational, PDI Valid	Inactive	Inactive	Operational, PDI Valid	Operational, PDI Valid	Inactive
IOLink State	Operate	Operate	Operate	Init	Init	Operate	Operate	Init
Device Vendor Name	Phoenix Contact	Phoenix Contact	Phoenix Contact			Phoenix Contact	Phoenix Contact	
Device Product Name	ELR HS-IES-PT/S06AC-3-10L	AXL E IOL D08 M12 6P	AXL E IOL A11 U M12 R			AXL E IOL D18 M12 6P	CBNC 84 24DC/1-4A+ 10L	
Device Serial Number	1359238023	2033906684	3020032178			2033954353	1357590050	
Device Hardware Version	1	00	03			00	1.00	
Device Firmware Version	1.10/1.11	1.01	1.10			1.01	1.00	
Device IO-Link Version	1.1	1.1	1.1			1.1	1.1	
Actual Cycle Time	30.0ms	4.0ms	4.0ms			4.0ms	40.0ms	
Device Minimum Cycle Time	30.0ms	8.0ms	2.0ms			0.0ms	40.0ms	
Configured Minimum Cycle Time	4ms	4ms	4ms			4ms	4ms	
Data Storage Capable	Yes	Yes	No			No	Yes	
Automatic Data Storage Configuration	Disabled	Disabled	Disabled	Disabled	Disabled	Disabled	Disabled	Disabled
Auxiliary Input (AI) Bit Status	Off	Off	Off	Off	Off	Off	Off	Off
Device PDI Data Length	8	1	2			2	8	
PDI Data Valid	Yes	Yes	Yes			Yes	Yes	
Last Rx PDI Data (MS Byte First)	00 00 00 00 00 00 00 01	04	00 00			00 00	00 13 13 00 00 00 00 00	
PDO Lock Enable	Yes	Yes	Yes	Yes	Yes	Yes	Yes	Yes
PDO Locked	No	No	No	No	No	No	No	No
Device PDO Data Length	2	1	2			0	3	
PDO Data Valid	No	No	No				No	
Last Tx PDO Data (MS Byte First)	00 00	00	00 00				00 00 00	
Time Since Initialization	2d 16:41:36	2d 16:41:36	2d 16:41:36			2d 16:41:36	2d 16:41:36	
Process Data Errors	0	0	0			0	0	
Process Data Retries	0	0	0			0	0	
Total Events	2	2	2	0	0	2	2	0
First Events	1) Single_Message_Local_0024h 0)_unsupprble 2) Cleared_Error_Local_0010h &_ServiceLost	1) Single_Message_Local_0024h 0)_unsupprble 2) Cleared_Error_Local_0010h &_ServiceLost	1) Single_Message_Local_0024h 0)_unsupprble 2) Cleared_Error_Local_0010h &_ServiceLost			1) Single_Message_Local_0024h 0)_unsupprble 2) Cleared_Error_Local_0010h &_ServiceLost	1) Single_Message_Local_0024h 0)_unsupprble 2) Cleared_Error_Local_0010h &_ServiceLost	
Last Events	1) Single_Message_Local_0024h 0)_unsupprble 2) Cleared_Error_Local_0010h &_ServiceLost	1) Single_Message_Local_0024h 0)_unsupprble 2) Cleared_Error_Local_0010h &_ServiceLost	1) Single_Message_Local_0024h 0)_unsupprble 2) Cleared_Error_Local_0010h &_ServiceLost			1) Single_Message_Local_0024h 0)_unsupprble 2) Cleared_Error_Local_0010h &_ServiceLost	1) Single_Message_Local_0024h 0)_unsupprble 2) Cleared_Error_Local_0010h &_ServiceLost	
ISDU Statistics								
ISDU Read Cmd Attempts	34	34	34	0	0	34	34	0
ISDU Read Cmd Errors	0	0	0	0	0	0	0	0
ISDU Write Cmd Attempts	0	0	0	0	0	0	0	0
ISDU Write Cmd Errors	0	0	0	0	0	0	0	0

Figure 5-2 “IO-Link Diagnostics” page

Table 5-1 provides information about the fields on the “IO-Link Diagnostics” page.

Table 5-1 “IO-Link Diagnostics” page field descriptions

Field name	Description
Port Name	This is an optional user-friendly port name, which can be configured in the Configuration IO-Link page (see “Editing the IOL MA8 PN D18 port settings” on page 31).
Port Mode	Displays the active device mode: <ul style="list-style-type: none"> – Reset = The port is configured to disable all functionality. – IO-Link = The port is configured to IO-Link mode. – DigitalIn = The port is configured to operate as a digital input. – DigitalOut = The port is configured to operate as a digital output.
Port Status	Displays the port status: <ul style="list-style-type: none"> – Inactive: The port is in an inactive state. Typically, this indicates that the device is either not attached or not detected. – Initializing: The port is in the process of initializing. – Operational: The port is operational and, if in IO-Link mode, communication to the IO-Link device is established. – PDI Valid: The PDI data is now valid. – Fault: The port has detected a fault and is unable to re-establish communication.
IO-Link State	<ul style="list-style-type: none"> – Operate: Port is functioning correctly in IO-Link mode but has not received valid PDI data. This may also display during a data storage upload or download. – Init: The port is attempting initialization. – Reset: One of the following conditions exists: <ul style="list-style-type: none"> – The Port Mode configuration is set to Reset. – The Port Mode configuration is set to DigitalIn or DigitalOut. – DS - Wrong Sensor: Hardware failure (IO-Link LED also flashes red) because there is Data Storage on this port that does not reflect the attached device. – DV - Wrong Sensor: Hardware failure (IO-Link LED also flashes red) because Device Validation is configured for this port and the wrong device is attached. – DS - Wrong Size: Hardware failure (IO-Link LED also flashes red) because the size of the configuration on the device does not match the size of the configuration stored on the port. – Comm Lost: Temporary state after a device is disconnected and before the port is re-initialized. – Pre-operate: Temporary status displayed when the device: <ul style="list-style-type: none"> – Is starting up after connection or power-up. – Uploading or downloading automatic data storage.
Device Vendor Name	Displays the “Device Vendor Name” as stored in ISDU Index 16.
Device Product Name	Displays the “Device Product Name” as stored in ISDU Index 18.
Device Serial Number	Displays the “Device Serial Number” as stored in ISDU Index 21.
Device Hardware Version	Displays the “Device Hardware Version” as stored in ISDU Index 22.
Device Firmware Version	Displays the “Device Firmware Version” as stored in ISDU Index 23.
Device IO-Link Version	The supported device IO-Link version as stored in ISDU Index 0.
Actual Cycle Time	This is the actual, or current, cycle time of the IO-Link connection to the device.
Device Minimum Cycle Time	This is the minimum, or fastest, cycle time supported by the connected IO-Link device.

Table 5-1 “IO-Link Diagnostics” page field descriptions [...]

Field name	Description
Configured Minimum Cycle Time	This is the minimum cycle time at which the IO-Link will allow the port to operate. The Actual Cycle Time, which is negotiated between the IO-Link device and the IOL MA8 PN DI8, will be at least as long as the greater of the Configured Minimum Cycle Time and the Device Minimum Cycle Time (see “Editing the IOL MA8 PN DI8 port settings” on page 31).
Data Storage Capable	Displays whether the IO-Link device on a port supports the data storage feature. The IO-Link device manufacturer determines if the device supports data storage.
Automatic Data Storage Configuration	Displays whether a port is configured to automatically upload data from the IO-Link device or download data from the IOL MA8 PN DI8 to the IO-Link device. Disabled indicates automatic upload or download are not enabled.
Auxiliary Input (AI) Bit Status	Displays the status of the auxiliary digital input DI signal.
Device PDI Data Length	The supported Device PDI Data Length, in bytes, as stored in ISDU Index 0.
PDI Data Valid	Current status of PDI data as received from the IO-Link device.
Last Rx PDI Data (MS Byte First)	The last Rx PDI data as received from the IO-Link device.
Device PDO Data Length	The supported Device PDO Data Length, in bytes, as stored in ISDU Index 0.
PDO Data Valid	Status of PDO data being received from the controller(s).
Last Tx PDO Data (MS Byte First)	The last Tx PDO data.
Time Since Initialization	The time since the last port initialization.
Process Data Errors	The number of process data errors the port received.
Process Data Retries	The number of process data retries the port performed.
Total Events	The total number of events received on this port.
First Events	Up to the first, or oldest, three events received on this port.
Last Events	Up to the last, or most recent, three events received on this port.
ISDU Statistics	
ISDU Read Cmd Attempts	The number of read ISDU command attempts.
ISDU Read Cmd Errors	The number of read ISDU command errors.
ISDU Write Cmd Attempts	The number of write ISDU command attempts.
ISDU Write Cmd Errors	The number of write ISDU command errors.

5.1.2 PROFINET IO diagnostics

The “PROFINET IO Diagnostics” page may be useful when trying to troubleshoot PROFINET communications and port issues related to PROFINET configuration.

PROFINET IO Diagnostics [UPDATE] [STOP LIVE UPDATES] [RESET STATISTICS]

PROFINET IO GENERAL STATUS

Active Application Relationships	1
Application Relationship 1 Uptime	0:05:31
Application Relationship 2 Uptime	
Total Application Relationships Established	1
IOL_CALL Function Block Requests	0
IOL_CALL Function Block Errors	0
Configuration Errors	0
System Errors	0
PROFINET IO Frames Transmitted	44907
PROFINET IO Transmit Errors	0
PROFINET IO Frames Received	3856
PROFINET IO Receive Errors	0
Record Reads	0
Record Read Errors	0
Digital IO Input Status Changes	0
Digital IO Writes	0
Digital IO Write Errors	0
IP Assignment	IO Controller
Ethernet Port 1 Link Status	100Mbps Full Duplex
Ethernet Port 2 Link Status	100Mbps Full Duplex
First Error String	Ethernet Port 1: link down
Last Error String	Ethernet Port 1: link down

PROFINET IO PORT STATUS

	PORT 1	PORT 2	PORT 3	PORT 4	PORT 5
Application Relationship					
PDI Reads	0	0	0	0	0
PDI Reads Truncated	0	0	0	0	0
PDI Read Errors	0	0	0	0	0
PDI Writes	0	0	0	0	0
PDI Write Errors	0	0	0	0	0
SIO Input Status Changes	0	0	0	0	0
SIO Output Writes	0	0	0	0	0
SIO Output Write Errors	0	0	0	0	0
Auxiliary Input Status Changes	0	0	0	0	0
Event Reads	0	0	0	0	0
Event Read Errors	0	0	0	0	0
Get Port Mode Errors	0	0	0	0	0
Set Port Mode Errors	0	0	0	0	0
ISDU Request Misses from PLC(s)	0	0	0	0	0
ISDU Invalid Requests	0	0	0	0	0
Void ISDU Responses from Port	0	0	0	0	0
ISDU Response Timeouts	0	0	0	0	0
Maximum ISDU Request Response Time					
Average ISDU Request Response Time					
Minimum ISDU Request Response Time					
ISDU Read Commands	0	0	0	0	0
ISDU Read Failures	0	0	0	0	0
ISDU Write Commands	0	0	0	0	0
ISDU Write Failures	0	0	0	0	0
Process Alarms	0	0	0	0	0
Return of Submodule Alarms	0	0	0	0	0
Channel Diagnostics Alarms Added	0	0	0	0	0
Channel Diagnostics Alarm Removed	0	0	0	0	0
Alarm Errors	0	0	0	0	0

Welcome Admin Phoenix Contact

Figure 5-3 “PROFINET IO Diagnostics” page

The following table provides information about the fields shown on the “PROFINET IO Diagnostics” page.

Table 5-2 “PROFINET IO Diagnostics” page field descriptions

Field name	Description
Active Application Relationships	Displays the current number of active PROFINET IO connections.
Application Relationship 1 Uptime	The uptime of the first application relationship.
Application Relationship 2 Uptime	The uptime of the second application relationship.
Total Application Relationships Established	The total number of application relationships that have been established since power up.
IOL_CALL Function Block Requests	The total number of IOL_CALL function block requests received.
IOL_CALL Function Block Errors	The number of errors when handling IOL_CALL function block requests.
Configuration Errors	The number of system configuration related errors.
System Errors	Displays the number of system resource errors. These errors indicate a system error on the IO-Link, such as operating system errors or full message queues. These errors typically occur when the PLC is sending messages to the IO-Link master faster than the IO-Link master can process them.
PROFINET IO Frames Transmitted	The total number of transmitted PROFINET IO frames.
PROFINET IO Transmit Errors	The number of errors when transmitting PROFINET IO frames.
PROFINET IO Frames Received	The total number of received PROFINET IO frames.
PROFINET IO Receive Errors	The number of errors when receiving PROFINET IO frames.
Record Reads	The total number of record read requests received.
Record Read Errors	The number of errors when handling record read requests.
Digital IO Input Status Changes	The number of times that the status of the all digital I/O pins have changed.
Digital IO Writes	The number of times that the status of the digital output pins have changed.
Digital IO Write Errors	The number of errors when writing to digital output pins.
IP Assignment	The current IP assignment method.
Ethernet Port 1 Link Status	Current link status of Ethernet port 1.
Ethernet Port 2 Link Status	Current link status of Ethernet port 2.
First Error String	Text description of the first error that occurred.
Last Error String	Text description of the last error that occurred.
PROFINET IO Port Status	
Application Relationship	The application relationship (1 or 2) that the IO-Link port belongs to.
PDI Reads	The number of PDI reads.
PDI Reads Truncated	The number of PDI reads that are truncated due to size.
PDI Read Errors	The number of errors when reading PDI.

Table 5-2 “PROFINET IO Diagnostics” page field descriptions

Field name	Description
PDO Writes	The number of PDI writes.
PDO Write Errors	The number of errors when reading PDO.
SIO Input Status Changes	The number of time the status of C/Q pin has changed when a port is in SIO input mode.
SIO Output Writes	The number of time the status of C/Q pin has changed when a port is in SIO output mode.
SIO Output Write Errors	The number of errors when writing to C/Q pin when a port is in SIO output mode.
Auxiliary Input Status Changes	The number of time the status of auxiliary pin has changed.
Event Reads	The number of IO-Link events.
Event Read Errors	The number of errors when reading IO-Link events.
Get Port Mode Errors	The number of errors when getting IO-Link port mode.
Set Port Mode Errors	The number of errors when setting IO-Link port mode.
ISDU Request Msgs From PLC(s)	Displays the number of ISDU request messages received from the PLC(s) or other controllers. These request messages may contain one or multiple ISDU commands.
ISDU Invalid Requests	Displays the number of ISDU requests received over PROFINET IO with one or more invalid commands.
Valid ISDU Responses From Port	Displays the number of valid ISDU response messages returned from the IO-Link port interface and available to the PLC(s). The response messages contain results to the ISDU command(s) received in the request message.
ISDU Response Timeouts	Displays the number of ISDU requests that did not receive a response within the configured ISDU Response Timeout.
Maximum ISDU Request Msg Response Time	Displays the maximum time period required to process all commands within an ISDU request message. The response is not available until all ISDU command(s) contained in the request have been processed.
Average ISDU Request Msg Response Time	Displays the average time period required to process the ISDU request message(s). The response is not available until all ISDU command(s) contained in the request have been processed.
Minimum ISDU Request Msg Response Time	Displays the minimum time period required to process all commands within an ISDU request message. The response is not available until all ISDU command(s) contained in the request have been processed.
Minimum ISDU Request Msg Response Time	Displays the minimum time period required to process all commands within an ISDU request message. The response is not available until all ISDU command(s) contained in the request have been processed.
ISDU Read Commands	Displays the number of ISDU read commands received over PROFINET IO.
ISDU Read Failures	The number of errors when processing ISDU read commands.
ISDU Write Commands	Displays the number of ISDU write commands received over PROFINET IO.
ISDU Write Failures	The number of errors when processing ISDU write commands.
Process Alarms	The number of process alarms sent to PLC.
Return of Submodule Alarms	The number of Return of Submodule alarms sent to PLC.
Channel Diagnostics Alarms Added	The number of channel diagnostics alarms sent to PLC.
Channel Diagnostics Alarms Removed	The number of channel diagnostics alarms removed from PLC.
Alarm Errors	The number errors when handling PROFINET IO alarms.

5.1.3 Modbus TCP diagnostics

The “Modbus TCP Diagnostics” page may be useful when trying to troubleshoot Modbus TCP communications or port issues related to the Modbus TCP configuration

IO-LINK PROFINET IO MODBUS TCP OPC UA IOL M48 PN DIS

Home Diagnostics Configuration Device Maintenance Attached Devices

IO-LINK PROFINET IO MODBUS TCP OPC UA IOL M48 PN DIS

Modbus TCP Diagnostics [UPDATE] [STOP LIVE UPDATES] [RESET STATISTICS]

MODBUS TCP GENERAL STATUS	
Modbus TCP Server Enable	enable
Active Connections	1
Messages Received From Masters	2212
Responses Sent To Masters	2213
Broadcasts Received	0
Invalid Message Length Errors	0
Invalid Message Data Errors	0
Invalid Message Address Errors	24
Unknown Device ID Errors	0
Invalid Protocol Type Errors	0
Unsupported Function Code Errors	0
Configuration Errors	0
No Available Connection Errors	0
System Resource Errors	0
First Error String	Invalid Modbus data address of: Read Holding Registers out of range 1 (base 1)
Last Error String	Invalid Modbus data address of: Read Holding Registers out of range 1 (base 1)

MODBUS TCP PORT STATUS	PORT 1	PORT 2	PORT 3	PORT 4	PORT 5			
Active PDO Controller(s)								
PDO Writes to Offline or Read-Only Ports	0	0	0	0	0			
ISDU Request Msgs from PLC(s)	0	0	0	0	0			
ISDU Invalid Requests	0	0	0	0	0			
ISDU Requests When Port Offline	0	0	0	0	0			
Valid ISDU Responses from Port	0	0	0	0	0			
ISDU Response Timeouts	0	0	0	0	0			
Unexpected ISDU Responses	0	0	0	0	0			
Maximum ISDU Request Msg Response Time								
Average ISDU Request Msg Response Time								
Minimum ISDU Request Msg Response Time								
ISDU Read Commands	0	0	0	0	0			
ISDU Write Commands	0	0	0	0	0			
ISDU NOP Commands	0	0	0	0	0			

Welcome Admin Phoenix Contact

Figure 5-4 “Modbus TCP Diagnostics” page

The following table provides information about the fields displayed on “Modbus TCP Diagnostics” page.

Table 5-3 “Modbus/TCP Diagnostics” page field description

Field name	Description
Active Connections	Displays the current number of active Modbus TCP connections.
Messages Received from Masters	Displays the number of Modbus messages received from Modbus TCP Masters.
Responses Sent to Masters	Displays the number of Modbus responses sent to Modbus TCP Masters.
Broadcasts Received	Displays the number of broadcast Modbus TCP messages received.
Invalid Message Length Errors	Displays the number of Modbus messages received with incorrect length fields.
Invalid Message Data Errors	Displays the number of invalid message data errors. These errors occur when the IOL MA8 PN DI8 receives a message that cannot be performed due to invalid data.
Invalid Message Address Errors	Displays the number of invalid message address errors. These errors occur when the IOL MA8 PN DI8 receives a message that cannot be performed due to an invalid address.
Unknown Device ID Errors	Displays the number of unknown device ID errors. These errors occur when the IOL MA8 PN DI8 receives a message addressed to a device ID other than the configured Slave Mode Device ID.
Invalid Protocol Type Errors	Displays the number of invalid message protocol type errors. These errors occur when the IOL MA8 PN DI8 receives a Modbus TCP message that specifies a non-Modbus protocol.
Unsupported Function Code Errors	Displays the number of invalid Modbus function code errors. These errors occur when the IOL MA8 PN DI8 receives a message that cannot be performed due to an unsupported Modbus function code.
Configuration Errors	Displays the number of improper configuration errors. These errors occur when the IOL MA8 PN DI8 receives a message that cannot be performed due to an invalid configuration.
No Available Connection Errors	Displays the number of Modbus TCP connection attempts rejected due to no available connections. This occurs when the number of Modbus TCP connections has reached the limit.
System Resource Errors	Displays the number of system resource errors. These errors indicate a system error on the IOL MA8 PN DI8, such as operating system errors or full message queues. These errors typically occur when the PLC(s) are sending messages to the IOL MA8 PN DI8 faster than the IOL MA8 PN DI8 can process them.
First Error String	Text description of the first error that occurred.
Last Error String	Text description of the last error that occurred.
Modbus TCP Port Specific Diagnostics	
Active PDO Controller(s)	Lists the controller interface(s) type (Class 1 or Class 3) and IP address controlling the PDO data.
PDO Writes to Offline or Read-Only Ports	Displays the number of PDO write messages dropped due to any of the following: <ul style="list-style-type: none"> – The port is configured in IO-Link mode: <ul style="list-style-type: none"> – There is no device connected to the port. – The IO-Link device is off line. – The IO-Link device does not support PDO data. – PDO Transmit Mode (To PLC) is disabled. – The port is configured in Digital Input mode.

Table 5-3 “Modbus/TCP Diagnostics” page field description [...]

Field name	Description
ISDU Request Msgs From PLC(s)	Displays the number of ISDU request messages received from the PLC(s) or other controllers. These request messages may contain one or multiple ISDU commands.
ISDU Invalid Requests	Displays the number of ISDU requests received over Modbus TCP with one or more invalid commands.
ISDU Requests When Port Offline	Displays the number of ISDU requests received over Modbus TCP when the IO-Link port was offline. This can occur when: <ul style="list-style-type: none"> – The IO-Link port is initializing, such as after startup. – There is no IO-Link device attached to the port. – The IO-Link device is not responding. – Communication to the IO-Link device has been lost.
Valid ISDU Responses From Port	Displays the number of valid ISDU response messages returned from the IO-Link port interface and available to the PLC(s). The response messages contain results to the ISDU command(s) received in the request message.
ISDU Response Timeouts	Displays the number of ISDU requests that did not receive a response within the configured ISDU Response Timeout.
Unexpected ISDU Responses	Displays the number of unexpected ISDU responses. Unexpected responses may occur when an ISDU response is received after the ISDU request has timed out. This typically requires setting the ISDU Response Timeout to a longer value.
Maximum ISDU Request Msg Response Time	Displays the maximum time period required to process all commands within an ISDU request message. The response is not available until all ISDU command(s) contained in the request have been processed.
Average ISDU Request Msg Response Time	Displays the average time period required to process the ISDU request message(s). The response is not available until all ISDU command(s) contained in the request have been processed.
Minimum ISDU Request Msg Response Time	Displays the minimum time period required to process all commands within an ISDU request message. The response is not available until all ISDU command(s) contained in the request have been processed.
ISDU Read Commands	Displays the number of ISDU read commands received over Modbus TCP.
ISDU Write Commands	Displays the number of ISDU write commands received over Modbus TCP.
ISDU NOP Commands	Displays the number of ISDU NOP (no operation) commands received over Modbus TCP.

5.1.4 OPC UA diagnostics

Shows whether the OPC UA feature is enabled or disabled and the number of TCP connections.

The screenshot shows the 'OPC UA Diagnostics' page. At the top, there is a navigation bar with 'Home', 'Diagnostics', 'Configuration', 'Device Maintenance', and 'Attached Devices'. The 'Diagnostics' tab is active. Below the navigation bar, there are buttons for 'UPDATE', 'STOP LIVE UPDATES', and 'RESET STATISTICS'. The main content area is titled 'OPC UA Diagnostics' and contains a table with the following data:

OPC UA GENERAL STATUS	
OPC UA Server Enable	enable
Number of TCP connections	1
TCP connection #1	<pre>192.168.254.101:23869 id: 25 state: ESTABLISHED channel mode: 0 1 session: id: {50C7408B-46C3-5178-F33FF3EF8078E75E} name: 'urn:LT-US-11043:UnifiedAutomation:UaExpert' activated: 1 subscriptions: id1: 1 monitored items client: app: 'urn:LT-US-11043:UnifiedAutomation:UaExpert' product: 'urn:UnifiedAutomation:UaExpert' name: 'Unified Automation UaExpert'</pre>

At the bottom of the page, there is a footer with 'Welcome Admin' on the left and 'Phoenix Contact' on the right.

Figure 5-5 The “OPC UA Diagnostics” page

OPC UA Server Enable: Displays the status of the OPC UA server in the IOL MA8 PN DI8.

Number of TCP connections: Displays the number of OPC UA clients actively connected.

5.2 Configuration

Depending on environment, the IOL MA8 PN DI8 may not need to change many of the default options.

5.2.1 Preparing for port configuration

Before beginning port configuration, verify that the connected device is functioning. This data is updated with the live update function providing constant updates. If desired, click the “STOP LIVE UPDATES” button to stop the live updates. Update data immediately by clicking the “UPDATE” button.

1. If necessary, log in to the IOL MA8 PN DI8.
2. Click the “Diagnostics” tab, and then the “IO-LINK” subtab to open the “IO-Link Diagnostics” page.

The screenshot displays the 'IO-Link Diagnostics' page for 'PORT 1'. The page features a navigation bar with tabs for 'IO-LINK', 'PROFINET IO', 'MODBUS TCP', and 'OPC UA'. The main content area is titled 'IO-Link Diagnostics' and includes a 'STOP LIVE UPDATES' button and a 'RESET STATISTICS' button. Below this is a table with the following data:

IO-LINK PORT STATUS	PORT 1
Port Name	IOLink Port 1
Port Mode	IOLink
Port Status	Operational, PDI Valid
IOLink State	Operate
Device Vendor Name	Phoenix Contact
Device Product Name	ELR H5-IES-PT/500AC-3-IOL
Device Serial Number	1358238023
Device Hardware Version	1
Device Firmware Version	1.10/1.11
Device IO-Link Version	1.1
Actual Cycle Time	30.0ms
Device Minimum Cycle Time	30.0ms
Configured Minimum Cycle Time	4ms
Data Storage Capable	Yes
Automatic Data Storage Configuration	Disabled
Auxiliary Input (AI) Bit Status	Off
Device PDI Data Length	8
PDI Data Valid	Yes
Last Rx PDI Data (MS Byte First)	00 00 00 00 00 00 00 01
PDO Lock Enable	Yes
PDO Locked	No
Device PDO Data Length	2
PDO Data Valid	No
Last Tx PDO Data (MS Byte First)	00 00
Time Since Initialization	2d 16:36:16
Process Data Errors	0
Process Data Retries	0
Total Events	2
First Events	1)Single,Message,Local,0024h m_preoperate 2)Cleared,Error,Local,0010h s_devicelost
Last Events	1)Single,Message,Local,0024h m_preoperate 2)Cleared,Error,Local,0010h s_devicelost
ISDU Statistics	
ISDU Read Cmd Attempts	18
ISDU Read Cmd Errors	0
ISDU Write Cmd Attempts	0
ISDU Write Cmd Errors	0

At the bottom of the page, there is a 'Welcome Admin' message on the left and 'Phoenix Contact' on the right.

Figure 5-6 “IO-Link Diagnostics” page

3. Review the “Port Status” and “IO-Link State” fields.

Table 5-4 Port status and IO-Link state description

Field name	Status	Indication
Port Status	Operational, PDI Valid	An IO-Link device is operating on the port that has received valid PDI data.
	Operational	An IO-Link device is operating on the port that has not received valid PDI data.
	Inactive	One of the following conditions exists: <ul style="list-style-type: none"> – A valid IO-Link device is not connected to the port. – A digital input or output device is connected to the port but the configured Port Mode is not correct.
IO-Link State	Operate	Port is functioning correctly in IO-Link mode but has not received valid PDI data. This may also display during a data storage upload or download.
	Init	The port is attempting initialization.
	Reset	One of the following conditions exists: <ul style="list-style-type: none"> – The Port Mode configuration is set to Reset. – The Port Mode configuration is set to DigitalIn or DigitalOut.
	DS: Wrong Sensor	Hardware failure (IO-Link LED also flashes red) because there is Data Storage on this port, which does not reflect the attached device.
	DV: Wrong Sensor	Hardware failure (IO-Link LED also flashes red) because Device Validation is configured for this port and the wrong device is attached.
	DS: Wrong Size	Hardware failure (IO-Link LED also flashes red) because the size of the configuration on the device does not match the size of the configuration stored on the port.
	Comm Lost	Temporary state after a device is disconnected and before the port is re-initialized.
	Pre-operate	Temporary status displayed when the device: <ul style="list-style-type: none"> – Is starting up after connection or power-up. – Uploading or downloading automatic data storage.

If a digital input or output device is connected to an IOL MA8 PN DI8 port, there is no valid data until the port is set to the correct Port Mode.

Review the “Device IO-Link Version” field.

- If the field is blank, it is not a valid IO-Link device, which could mean that it is a digital device and the port is not configured for digital input or digital output.
- The field displays the Device IO-Link version.

Optionally, review the “Configured Minimum Cycle Time” field value. The “Configured Minimum Cycle Time” field is the minimum cycle time allowed for the port. The “Actual Cycle Time” field value is negotiated between the IOL MA8 PN DI8 and the IO-Link device, and will be at least as long as the greater of the “Configured Minimum Cycle Time” and the “Device Minimum Cycle Time” fields.

Verify that the “Auxiliary Input Bit Status” field displays **On**, if the device is connected to the DI pos. circuit.

5.2.2 IO-Link configuration

When the IO-Link device is attached to a port, it begins operating without requiring any configuration. The IOL MA8 PN DI8 and attached IO-Link device automatically negotiate the “Minimum Cycle Time” value. If required by an application, set a specific “Minimum Cycle Time” value.

This page provides special features such as Data Storage, Device Validation, and Data Validation.

Editing the IOL MA8 PN DI8 port settings

If an IO-Link device is attached to the port, no configuration is required for operation. If a digital input or output device is attached, it is necessary to change the Port Mode.

1. If necessary, open the IOL MA8 PN DI8 interface with the browser using the IP address.
2. Click the “Configuration” tab, and then click the “IO-LINK” subtab to access the “IO-Link” page.

IO-LINK PORT CONFIG	PORT 1	PORT 2	PORT 3	PORT 4	PORT 5	PORT 6
	<input type="button" value="EDIT"/>	<input type="button" value="EDIT"/>	<input type="button" value="EDIT"/>	<input type="button" value="EDIT"/>	<input type="button" value="EDIT"/>	<input type="button" value="EDIT"/>
Port Name	IOLink Port 1	IOLink Port 2	IOLink Port 3	IO-Link Port 4	IO-Link Port 5	IO-Link Port 6
Port Mode	IOLink	IOLink	IOLink	IOLink	IOLink	IOLink
PDO Lock Enable	true	true	true	true	true	true
Invert SIO	false	false	false	false	false	false
Invert Auxiliary Input	false	false	false	false	false	false
Default Digital Output	Off	Off	Off	Off	Off	Off
Minimum Cycle Time (4 - 538)	4 ms	4 ms	4 ms	4 ms	4 ms	4 ms
Auxiliary Input Settling Time (0 - 10000)	0 ms	0 ms	0 ms	0 ms	0 ms	0 ms
Auxiliary Input Hold Time (0 - 10000)	0 ms	0 ms	0 ms	0 ms	0 ms	0 ms
SIO Input Settling Time (0 - 10000)	0 ms	0 ms	0 ms	0 ms	0 ms	0 ms
SIO Input Hold Time (0 - 10000)	0 ms	0 ms	0 ms	0 ms	0 ms	0 ms
Data Storage Config						
Storage Contents	empty	empty	empty	empty	empty	empty

Figure 5-7 “IO-Link Settings” page

3. Click the “EDIT” button for the port to be configured.

The screenshot shows the 'IO-Link Settings' page in the Phoenix Contact web interface. At the top, there is a navigation bar with 'PHOENIX CONTACT' logo and menu items: Home, Diagnostics, Configuration, Device Maintenance, Attached Devices. The page title is 'IOL MA8 PN D18'. Below the navigation bar, there are tabs for 'IO-LINK', 'PROFINET IO', 'MODBUS TCP', 'OPC UA', 'LAN', 'UTILITIES', 'CONFIG FILES', and 'RESTORE DEFAULTS'. The main content area is titled 'IO-Link Settings' and contains a table for configuring five ports (PORT 1 to PORT 5). The table has columns for each port and buttons for 'CANCEL', 'SAVE', and 'EDIT'. The 'EDIT' button for PORT 1 is highlighted. Below the table, there are sections for 'Data Storage Config', 'Data Storage Manual Ops', and 'Validation Config'. The 'Data Storage Manual Ops' section has buttons for 'CLEAR', 'UPLOAD', and 'DOWNLOAD' for each port. The 'Validation Config' section has fields for 'Device Validation Mode', 'Vendor Id', 'Device Id', 'Serial Num', 'Data Validation Mode', 'PDI Length', and 'PDO Length' for each port.

IO-LINK PORT CONFIG	PORT 1	PORT 2	PORT 3	PORT 4	PORT 5
	<input type="button" value="CANCEL"/> <input type="button" value="SAVE"/>	<input type="button" value="EDIT"/>	<input type="button" value="EDIT"/>	<input type="button" value="EDIT"/>	<input type="button" value="EDIT"/>
Port Name	IOLink Port 1	IOLink Port 2	IOLink Port 3	IOLink Port 4	IOLink Port 5
Port Mode	IOLink	IOLink	IOLink	IOLink	IOLink
PDO Lock Enable	true	true	true	true	true
Invert SIO	false	false	false	false	false
Invert Auxiliary Input	false	false	false	false	false
Default Digital Output	Off	Off	Off	Off	Off
Minimum Cycle Time (4 - 538)	4 ms	4 ms	4 ms	4 ms	4 ms
Auxiliary Input Settling Time (0 - 10000)	0 ms	0 ms	0 ms	0 ms	0 ms
Auxiliary Input Hold Time (0 - 10000)	0 ms	0 ms	0 ms	0 ms	0 ms
SIO Input Settling Time (0 - 10000)	0 ms	0 ms	0 ms	0 ms	0 ms
SIO Input Hold Time (0 - 10000)	0 ms	0 ms	0 ms	0 ms	0 ms
Data Storage Config					
Storage Contents	empty	empty	empty	empty	empty
Automatic Upload Enable	Off	off	Off	Off	Off
Automatic Download Enable	Off	Off	Off	Off	Off
Data Storage Manual Ops					
	<input type="button" value="CLEAR"/>	<input type="button" value="CLEAR"/>	<input type="button" value="CLEAR"/>	<input type="button" value="CLEAR"/>	<input type="button" value="CLEAR"/>
	<input type="button" value="UPLOAD"/>	<input type="button" value="UPLOAD"/>			
	<input type="button" value="DOWNLOAD"/>	<input type="button" value="DOWNLOAD"/>			
Validation Config					
Device Validation Mode	None	None	None	None	None
Vendor Id (0 - 65535)	0	0	0	0	0
Device Id (0 - 16777215)	0	0	0	0	0
Serial Num					
Data Validation Mode	None	None	None	None	None
PDI Length (0 - 32)	0 byte	0 byte	0 byte	0 byte	0 byte
PDO Length (0 - 32)	0 byte	0 byte	0 byte	0 byte	0 byte
	<input type="button" value="GET ATTACHED"/>	<input type="button" value="GET ATTACHED"/>	<input type="button" value="GET ATTACHED"/>	<input type="button" value="GET ATTACHED"/>	<input type="button" value="GET ATTACHED"/>

Figure 5-8 Editing a port on the “IO-Link Settings” page



Click the “EDIT” button for all ports to quickly configure all port parameters.

4. Make appropriate selections for the device connected to that port (see [Table 5-5](#)).



NOTE:
Do not enable **Automatic Download**, and then attempt device configuration as **Automatic Download** returns the configuration to the stored settings on the IOL MA8 PN D18.

5. Click the "SAVE" button for each port.
6. Return to the "IO-Link Settings" page to verify that changes have taken effect.

IO-Link parameters

The "IO-Link Settings" page supports the following options.

Table 5-5 "IO-Link Settings" page parameters

Field name	Function
Port Name	User-defined port or device description. <ul style="list-style-type: none"> – Standard ASCII characters – Max length = 80 characters
Port Mode Default: <i>IO-Link</i>	Selected IO-Link port mode. Valid settings are: <ul style="list-style-type: none"> – Reset: Select to disable a port or to reset/restart an IO-Link port. – IO-Link: Select to connect and operate an IO-Link device on the port. – Digital In: Select if a DI device is attached to the port. – Digital Out: Select if a DO device is attached to the port.
Invert SIO Default: <i>False</i>	If enabled and the Port Mode is Digital In or Digital Out, this option inverts the SIO value. <ul style="list-style-type: none"> – False (Disabled - Do not invert SIO) – True (Enabled - Invert SIO) This option does not affect the auxiliary digital input.
Invert Auxiliary Input	If this option is enabled, the auxiliary digital input signal is inverted.
Default Digital Output Default: <i>Off</i>	If the port mode is Digital Out, defines the default digital output value used at startup and when there is no active PDO controller. <ul style="list-style-type: none"> – Off (low voltage) - 0 – On (high voltage) - 24V
Minimum Cycle Time Default: <i>4</i>	The minimum, or fastest, cycle time at which the IO-Link device may operate. The valid range is 4-538 ms. If the "Minimum Cycle Time" field is set to the default value, the IOL MA8 PN DI8 negotiates with the IO-Link device for its minimum cycle time. The "IO-Link Diagnostics" page displays the "Actual Cycle Time" value, which is the negotiated cycle time. <div style="border: 1px solid black; padding: 5px; display: inline-block;">  The IOL MA8 PN DI8 negotiates the "Minimum Cycle Time" value so it is not necessary to set a cycle time unless a specific cycle time is needed. </div>
Auxiliary Input Settling Time (0 - 10000)	The "Auxiliary Input Settling Time" value that remains constant before that input is considered/accepted. This is used to reduce false readings from a noisy digital signal.
Auxiliary Input Hold Time (0 - 10000)	This is how long the IOL MA8 PN DI8 keeps the input at its present value. For example, if the IO-Link detects the input has gone high, and the hold time is X milliseconds, then the IO-Link reports the input as high for X milliseconds, even though the input itself may have gone away already. If X is zero, then get the behavior currently in the field.
SIO Input Settling Time (0 - 10000)	The SIO input settling time that remains constant before that input is considered/accepted. This is used to reduce false readings from a noisy digital signal.
SIO Input Hold Time (0 - 10000)	This is how long the IOL MA8 PN DI8 keeps the input at its present value. For example, if the IO-Link detects the input has gone high, and the hold time is X milliseconds, then the IO-Link reports the input as high for X milliseconds, even though the input itself may have gone away already. If X is zero, the behavior currently in the field is shown.

Table 5-5 “IO-Link Settings” page parameters [...]

Field name	Function
Data Storage Config	
Storage Contents	Indicates that the data storage for the port is empty or displays the Vendor ID and Product ID of the data stored on that port.
Automatic Data Storage Upload Enable Default: <i>Off</i>	<p>When this option is initially set to On, the IOL MA8 PN D18 saves the data storage parameters (if the data storage is empty) from the IO-Link device to the IOL MA8 PN D18.</p> <p>Automatic upload occurs when the “Automatic Upload Enable” option is set to On and one of these conditions exists:</p> <ul style="list-style-type: none"> – There is no upload data stored on the gateway and the IO-Link device is connected to the port. – The IO-Link device has the DS_upload bit on (generally because the configuration via Teach buttons or configuration page has changed). <p>When a port contains data storage for an IO-Link device and the attached device has a Vendor and Device ID that do not match, the IO-Link LED on the IOL MA8 PN D18 flashes red to indicate a wrong device is attached. In addition, the “IO-Link Diagnostics” page displays DS: Wrong Sensor in the “IO-Link State” field.</p> <p>Not all device parameters are sent to data storage; this is determined by the IO-Link device manufacturer.</p>
Automatic Data Storage Download Enable Default: <i>Off</i>	<p>The data storage parameters on the IOL MA8 PN D18 are downloaded to the connected IO-Link device if:</p> <ul style="list-style-type: none"> – The “Automatic Download” option is enabled. – The data stored on the IOL MA8 PN D18 port contains the same Vendor ID and Product ID as the IO-Link device connected to the port. – Data storage parameters are also downloaded to the IO-Link device if configuration changes are made on the device causing the DS_upload bit to turn on and automatic upload is not enabled. – The IO-Link device requests an upload and the “Automatic Upload Enable” option is set to Off. <p>Disable the “Automatic Download” option because the IOL MA8 PN D18 will reload the data storage on the port down to the IO-Link device, if configuration parameters on the IO-Link device have changed and parameters are desired to remain loaded on the IO-Link device.</p> <div style="border: 1px solid black; padding: 5px; margin-top: 10px;">  Do not enable Automatic Upload and Automatic Download at the same time. </div>
Data Storage Manual Ops	<p>The “Manual Data Storage Ops” option provides the following functionality, if data storage is supported by the IO-Link device.</p> <ul style="list-style-type: none"> – CLEAR: Clears any stored data for an IO-Link device on this port. – UPLOAD: Uploads and stores the IO-Link device configuration on the IOL MA8 PN D18. – DOWNLOAD: Downloads the stored IO-Link device configuration from the IOL MA8 PN D18 to the IO-Link device attached to this port, if the Vendor ID and Device ID match.

Table 5-5 “IO-Link Settings” page parameters [...]

Field name	Function
Validation Config	
Device Validation Mode (Default: <i>None</i>)	<p>Device Validation Mode provides these options:</p> <ul style="list-style-type: none"> – None - this disables Device Validation Mode. – Compatible - permits a compatible IO-Link device (same Vendor ID and Device ID) to function on the corresponding port. – Identical - only permits an IO-Link device to function on the corresponding port as defined in the following fields: <ul style="list-style-type: none"> – Vendor ID – Device ID – Serial Number <p>Connecting an IO-Link device that is different than what is configured with “Data Validation” enabled will generate a DV: wrong sensor error.</p>
Vendor Id (0-65535)	<p>This is required if a Device Validation Mode other than None is selected.</p> <p>The Vendor ID can be manually entered in this field or click the “GET ATTACHED” button and the IO-Link automatically populates the field.</p>
Device Id (0-16777215)	<p>This is required if a Device Validation Mode other than None is selected.</p> <p>Enter a value in the “Device Id” field or click the “GET ATTACHED” button and the IO-Link automatically populates the field.</p>
Serial Num	<p>This is required if Identical for the Device Validation Mode is selected.</p> <p>The Serial Number can be manually entered in this field, or click the “GET ATTACHED” button and the IO-Link automatically populates the field.</p>
Data Validation Mode (Default: <i>None</i>)	<p>There are three Data Validation Modes:</p> <ul style="list-style-type: none"> – None: No data validation is performed on the port. – Loose: The slave device’s PDI/PDO lengths must be less than or equal to the user-configured values. – Strict: The slave device’s PDI/PDO lengths must be the same as the user-configured values.
PDI Length (0-32)	<p>This is input length of the Process Data Input (PDI) data field.</p> <p>This is required if a Data Validation Mode other than None is selected.</p> <p>Enter a value in the “PDI Length” field or click the “GET ATTACHED” button and the IO-Link automatically populates the field.</p>
PDO Length (0-32)	<p>This is input length of the Process Data Output (PDO) data field.</p> <p>This is required if a Data Validation Mode other than None is selected.</p> <p>Enter a value in the “PDO Length” field or click the “GET ATTACHED” button and the IO-Link automatically populates the field.</p>
GET ATTACHED (Button)	<p>After opening a port for editing, click the “GET ATTACHED” button to automatically populate the following fields with data from the IO-Link device:</p> <ul style="list-style-type: none"> – Vendor ID – Device ID – Serial Num – PDI Length – PDO Length

Data storage

Data storage provides the ability to upload parameters from a connected IO-Link device to the IOL MA8 PN D18 and/or download parameters from the IOL MA8 PN D18 to the IO-Link device. This feature may be used to:

- Quickly and easily replace a defective IO-Link device.
- Configure multiple IO-Link devices with the same parameters as fast as it takes to connect and disconnect the IO-Link device.

To determine whether an IO-Link device supports data storage, check one of the following:

- IOL MA8 PN D18 “Diagnostics” page: Check the “Data Storage Capable” field to see if it displays **Yes**.
- IOL MA8 PN D18 “Configuration” page: Check to see if the “UPLOAD” and “DOWNLOAD” buttons display under the “Data Storage Manual Ops” group. If only the “Clear” button is visible, the device on the port does not support data storage.

Uploading data storage to the IOL MA8 PN D18

The IO-Link device manufacturer determines which parameters are saved for data storage. Remember, the IO-Link device should be configured before enabling data storage unless using data storage to back up the default device configuration.

There are two methods to upload Data Storage using the “IO-Link Settings” page:

- **Automatic Enable Upload:** If a port is set to **On** for this option, the IOL MA8 PN D18 saves the data storage parameters (if the data storage is empty) from the IO-Link device to the IOL MA8 PN D18.

When this option is enabled and another IO-Link device is connected (different Vendor ID and Device ID), the IOL MA8 PN D18 “Diagnostics” page displays **DS: Wrong Sensor** in the IOL MA8 PN D18 “State” field and the IOL MA8 PN D18 port LED flashes red, indicating a hardware fault.

Automatic upload occurs when the “Automatic Upload Enable” field is set to **On** and one of these conditions exists:

- There is no upload data stored on the IOL MA8 PN D18 and the IO-Link device is connected to the port.
- The IO-Link device has the DS upload bit **on**.



Not all device parameters are sent to data storage. The IO-Link device manufacturer determines what parameters are sent to data storage.

- **Data Storage Manual Ops:** This allows the data storage parameters to be manually transferred between devices.
 - **CLEAR:** Click the “CLEAR” button to remove any data storage parameters from the IOL MA8 PN D18 for the selected port and associated IO-Link device.
 - **UPLOAD:** Click the “UPLOAD” button to transfer the data storage from the IO-Link device to the IOL MA8 PN D18. The contents of the data storage does not change unless it is uploaded again or cleared. Another IO-Link device with a different Vendor ID and Device ID can be attached to the port without causing a hardware fault.
 - **DOWNLOAD:** Click the “DOWNLOAD” button to transfer the data storage from the IOL MA8 PN D18 to the connected IO-Link device.

Downloading data storage to the IO-Link device

There are two methods to download Data Storage using the “IO-Link Settings” page:

- **Automatic Download Enable:** An automatic download occurs when the “Automatic Download Enable” field is set to **On** and one of these conditions exists:
 - The original IO-Link device is disconnected and an IO-Link device whose configuration data differs from the stored configuration data.
 - The IO-Link device requests an upload and the Automatic Upload Enable option is set to **Off**.



Do not enable both Automatic Upload and Download at the same time, the results are not reliable among IO-Link device manufacturers.

- **Data Storage Manual Ops:**
 - **DOWNLOAD:** Click the “DOWNLOAD” button to download the data storage from the selected port to the IO-Link device.
If an IO-Link device with a different Vendor ID and Device ID is attached to the port and a manual download is attempted, the IOL MA8 PN DI8 issues a hardware fault.

Automatic device configuration

Use the following steps to use an IOL MA8 PN DI8 port to configure multiple IO-Link devices with the same configuration parameters.

1. If necessary, configure the IO-Link device as required for the environment.
2. Click the “Configuration” tab, and then click the “IO-Link” subtab.
3. Click the “EDIT” button to select the port where the data is stored on the IOL MA8 PN DI8.
4. Click the “UPLOAD” button.
5. Click the “CONTINUE” button to the Continue to upload the data storage on IO-Link port [number] message.
6. Click the “OK” button to the Data storage upload successful on Port [number] message.
7. Set the Automatic Download Enable option to **On**.
8. Click the “SAVE” button.
9. Click the “Diagnostics” tab, and then click the “IO-Link” subtab.
10. Replace the IO-Link device on that port with the IO-Link device for automatic configuration.
11. Verify that the IO-Link device displays operational Port Status and the appropriate IO-Link state.
12. Repeat 10 and 11 for each configured device.

Automatic Device Configuration backup

The following procedure shows how to utilize data storage to automatically back up an IOL MA8 PN DI8 device configuration.

Use the manual UPLOAD feature to capture the latest settings.

1. Click the “Configuration” tab, and then click the “IO-Link” subtab.
2. Click the “EDIT” button for the port to store the data on the IOL MA8 PN DI8.
3. Select **On** in the drop-down menu for Automatic Data Storage Upload Enable.
4. Click the “SAVE” button.

When the “Configuration/IO-Link” page is refreshed, the “Storage Contents” field displays the Vendor ID and Device ID. In addition, the “IO-Link” page displays **Upload-Only** in the “Automatic Data Storage Configuration” field.

Device validation

Device validation is supported by many IO-Link devices. Device Validation Mode provides these options:

- **None:** Disables Device Validation Mode.
- **Compatible:** Permits a compatible IO-Link device (same Vendor ID and Device ID) to function on the corresponding port.
- **Identical:** Permits only the same IO-Link device (same Vendor ID, Device ID, and serial number) to function on the corresponding port.

To configure device validation:

1. Click the “Configuration” tab, and then click the “IO-Link” subtab.
2. Click the “EDIT” button.
3. From the “Device Validation Mode” drop-down menu, select **Compatible** or **Identical**.



A device serial number is required to select **Identical**. Without the serial number, the IOL MA8 PN D18 cannot identify a specific device.

4. Click the “GET ATTACHED” button or manually enter the Vendor ID, Device, ID, and serial number.
5. Click the “SAVE” button.

If the wrong or incompatible device is connected to the port, the IOL MA8 PN D18 port LED flashes red and no IO-Link activity occurs on the port until the issue is resolved.

In addition, the “IO-Link Diagnostics” page displays the following information.

The screenshot shows the 'IO-Link Diagnostics' page with a navigation bar at the top containing 'PHOENIX CONTACT', 'Home', 'Diagnostics', 'Configuration', 'Device Maintenance', 'Attached Devices', and 'IOL MA8 PN D18'. Below the navigation bar are links for 'IO-LINK', 'PROFINET IO', 'MODBUS TCP', and 'OPC UA'. The main content area has 'IO-Link Diagnostics' as a title and buttons for 'UPDATE', 'STOP LIVE UPDATES', and 'RESET STATISTICS'. A table displays the status of three ports:

IO-LINK PORT STATUS	PORT 1	PORT 2	PORT 3
Port Name	IOLink Port 1	IOLink Port 2	IOLink Port 3
Port Mode	IOLink	IOLink	IOLink
Port Status	Inactive	Inactive	Operational, PDI Valid
IOLink State	DV:WrongSensor	CommLost	Operate
Device Vendor Name			Phoenix Contact
Device Product Name			AXL E IOL AI1 U M12 R
Device Serial Number			3029032178
Device Hardware Version			03
Device Firmware Version			110
Device IO-Link Version			1.1

At the bottom of the page, there is a footer with 'Welcome Admin' on the left and 'Phoenix Contact' on the right.

Figure 5-9 “IO-Link Diagnostics” page indicating incorrect sensor connection

Data validation

To configure data validation:

1. Click the “Configuration” tab and then click the “IO-LINK” subtab.
 2. Click the “EDIT” button on the port to configure for data validation.
 3. From the “Data Validation Mode” drop-down menu, select **Loose** or **Strict**.
 - **Loose:** The slave device’s PDI/PDO lengths must be less than or equal to the user-configured values.
 - **Strict:** The slave device’s PDI/PDO lengths must be the same as the user-configured values.
 4. Click the “GET ATTACHED” button or manually enter the PDI and PDO length in the appropriate fields.
 5. Click the “SAVE” button.
- If data validation fails, the IO-Link port LED flashes red and the “IO-Link Diagnostics” page displays an error.

5.2.3 PROFINET IO configuration

Use the “PROFINET IO Settings” page to configure PROFINET IO options.

Editing the PROFINET IO settings

Use this procedure to configure PROFINET settings.

1. If necessary, open the IOL MA8 PN D18 interface with a browser using the IP address.
2. Click the “Configuration” tab, and then click the “PROFINET IO” subtab.

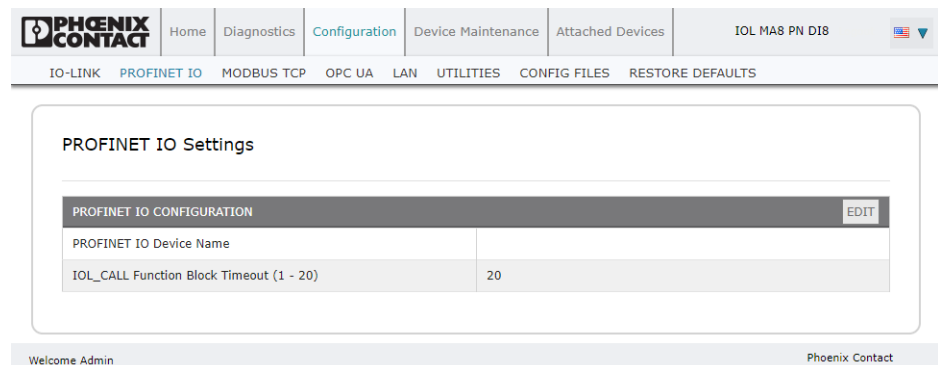

Figure 5-10 “PROFINET IO Settings” page

- **PROFINET IO Device Name:** May be assigned by the PROFINET controller or entered manually.
- **IOL_CALL Function Block Timeout (1-20):** The number of seconds that elapse between IOL_CALL function block requests before timing out. **20** seconds by default.

5.2.4 Modbus TCP configuration

Use the “Modbus TCP Settings” page to configure Modbus TCP with the IOL MA8 PN DI8.

Editing Modbus TCP settings

1. If necessary, open the IOL MA8 PN DI8 interface with the browser using the IP address. Click the “Configuration” tab, and then click the “Modbus TCP” subtab.

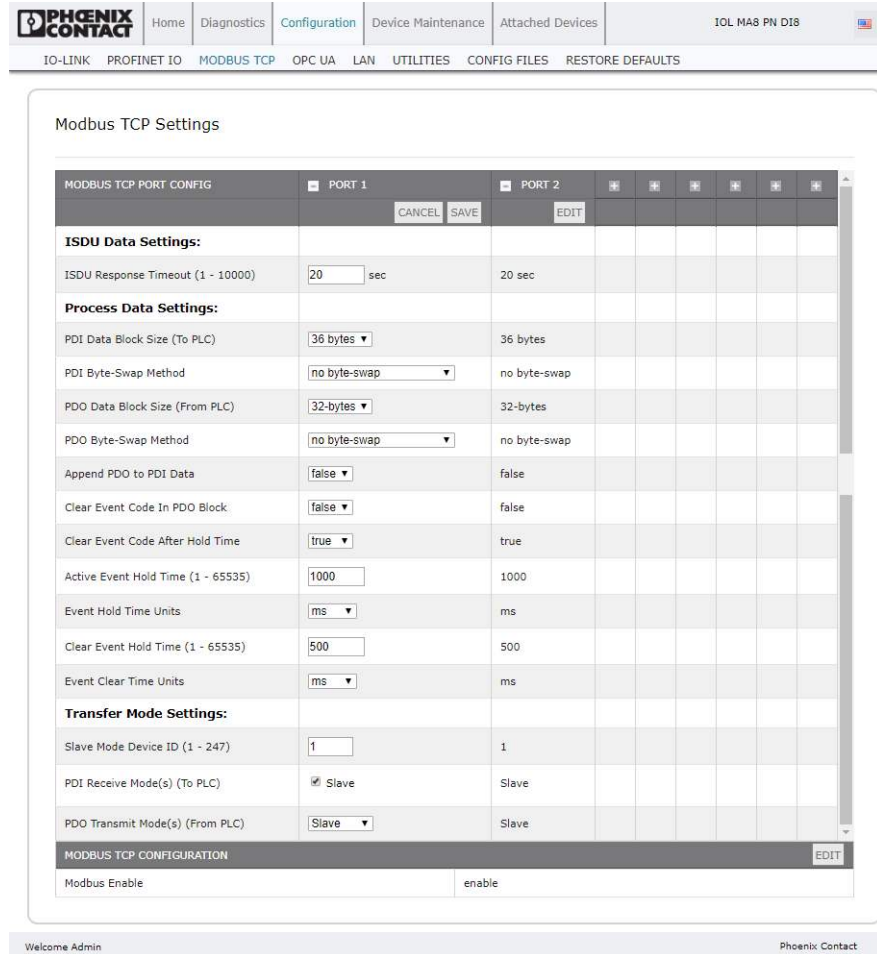

Figure 5-11 “Modbus TCP Settings” page

2. Click the “EDIT” button for the port(s) to configure.

MODBUS TCP PORT CONFIG		PORT 1	
		<input type="button" value="CANCEL"/> <input type="button" value="SAVE"/>	
ISDU Data Settings:			
ISDU Response Timeout (1 - 10000)	<input type="text" value="20"/>	sec	
Process Data Settings:			
PDI Data Block Size (To PLC)	<input type="text" value="36 bytes"/>		
PDI Byte-Swap Method	<input type="text" value="no byte-swap"/>		
PDO Data Block Size (From PLC)	<input type="text" value="32-bytes"/>		
PDO Byte-Swap Method	<input type="text" value="no byte-swap"/>		
Append PDO to PDI Data	<input type="text" value="false"/>		

Figure 5-12 Editing a port on the “Modbus TCP Settings” page



Click the “EDIT” button for all ports to quickly configure all port parameters.

3. Make appropriate selections for the device connected to that port. Scroll down to see all editable parameters.
4. Scroll to the top of the page and click the “SAVE” button.
 Make sure that the port now displays the “EDIT” button. If it displays the “SAVE” and “CANCEL” buttons, that means that one of the parameters contains an incorrect value. If necessary, scroll down the page, make the needed corrections, and click the “SAVE” button.

Modbus TCP parameters

The following table provides detailed information about the “Modbus TCP Settings” page.

Table 5-6 “Modbus TCP Settings” parameters

Field name	Function
ISDU Data Settings	
ISDU Response Timeout Default = 20 seconds	The time that the IOL MA8 PN DI8’s Modbus TCP interface waits for a response to an ISDU request. The timeout needs to set long enough to allow all commands within the ISDU request to be processed. Valid range: 1-10,000 seconds
Process Data Settings	
PDI Data Block Size (To PLC) Default: 36 bytes	The configurable PDI data block length. Optional lengths are: <ul style="list-style-type: none"> – 4 bytes (header only) – 8 bytes (4 bytes data) – 16 bytes (12 bytes data) – 24 bytes (20 bytes data) – 36 bytes (32 bytes data)
PDI Byte-Swap Method Default: No byte-swap	If enabled, the IOL MA8 PN DI8 swaps the data bytes in word 2-byte format or dword 4-byte format. Options include: <ul style="list-style-type: none"> – No byte-swap: Data passed through as received. – Word (16-bit) byte-swap: Data is byte-swapped in word format. – Dword (32-bit) byte-swap: Data is byte-swapped in dword format. – Reverse registers: Data passed through after being reversed. <div style="border: 1px solid black; padding: 5px; margin-top: 10px;">  <p>Because both IO-Link and Modbus TCP use big-endian byte ordering, byte-swapping typically is not required for word and dword data. Byte swapping is most commonly required when receiving byte (8-bit) data and it is desired to place the first data byte in the least significant byte position of the holding register. For these cases, word (16-bit) byte-swap is typically used.</p> </div>
PDO Data Block Size (From PLC) Default: 32-bytes	The configurable PDO data block length. Optional lengths are: <p>Event code not included:</p> <ul style="list-style-type: none"> – 4-bytes = 2 data words – 8-bytes = 4 data words – 16-bytes = 8 data words – 24-bytes = 12 data words – 32-bytes = 16 data words – 34-bytes = 16 data words, 1 pad word <p>Event code included:</p> <ul style="list-style-type: none"> – 4-bytes = event code word, 1 data word – 8-bytes = event code word, 3 data words – 16-bytes = event code word, 7 data words – 24-bytes = event code word, 11 data words – 32-bytes = event code word, 15 data words – 34-bytes = event code word, 16 data words

Table 5-6 “Modbus TCP Settings” parameters [...]



Field name	Function
PDO Byte-Swap Method Default: <i>No byte-swap</i>	If enabled, the IOL MA8 PN DI8 swaps the data bytes in word (2 byte) format or dword (4 byte) format. Options include: <ul style="list-style-type: none"> – No byte-swap: Data passed through as received – Word (16-bit) byte-swap: Data is byte-swapped in word format – Dword (32-bit) byte-swap: Data is byte-swapped in dword format – Reverse registers: Data passed through after being reversed <div style="border: 1px solid black; padding: 5px; margin-top: 10px;">  <p>Because both IO-Link and Modbus TCP use big-endian byte ordering, byte swapping typically is not required for word and dword data. Byte swapping is most commonly required when sending byte (8-bit) data to the IO-Link device and it is desired to send the least significant byte of the holding register first. For these cases, word (16-bit) byte-swap is typically used.</p> </div>
Append PDO to PDI Data Default: <i>False</i>	If selected, the IOL MA8 PN DI8 appends any PDO data to the end of the PDI data. <ul style="list-style-type: none"> – True (enable check box): Append PDO data. – False: Do not append PDO data.
Clear Event Code in PDO Block Default: <i>False</i>	If enabled, the IO-Link expects the first word of the PDO block to be used for event code handling. Values are: <ul style="list-style-type: none"> – True (enable check box): Expect event code. – False: No event code, expect only PDO data.
Clear Event Code After Hold Time Default: <i>True</i>	If enabled, the IOL MA8 PN DI8 clears any event code reported in the PDI data block after the Event Active Hold Time. Values are: <ul style="list-style-type: none"> – True (enable check box): Clear event code after hold time. – False: Do not clear event code after hold time.
Active Event Hold Time Default: <i>1000 ms</i>	If Clear Event Code After Hold Time is enabled, this is the time event code is held in the PDI block before it is cleared. Valid range: 1-65535 Valid units are: <ul style="list-style-type: none"> – ms (milliseconds) – sec (seconds) – min (minutes) – hours – days
Event Hold Time Units	Valid units: <ul style="list-style-type: none"> – ms (milliseconds) – sec (seconds) – min (minutes) – hours – days

Table 5-6 “Modbus TCP Settings” parameters [...]

Field name	Function
Clear Event Hold Time Default: 500 ms	Once an event code has been cleared, the time an event code stays cleared in the PDI block before another event code can be reported. Valid range: 1-65535 Valid units: <ul style="list-style-type: none"> - ms (milliseconds) - sec (seconds) - min (minutes) - hours - days
Event Clear Time Units	Valid units: <ul style="list-style-type: none"> - ms (milliseconds) - sec (seconds) - min (minutes) - hours - days
Transfer Mode Settings	
Slave Mode Device ID Default: 1	The Modbus Device ID used to access this IO-Link port. Range: 1-247
PDI Receive Mode(s) Default: <i>Slave</i>	Determines which PDI Receive (To PLC) Modes are enabled. The selectable modes is Slave . <div style="border: 1px solid black; padding: 5px; display: inline-block;">  Not selecting slave mode disables Modbus TCP access to the PDI data block. </div>
PDO Transmit Mode Default: <i>Slave</i>	Selectable modes are: <ul style="list-style-type: none"> - Disabled - Slave

5.2.5 OPC UA configuration

Use the “OPC UA Settings” page to configure OPC UA with the IOL MA8 PN D18.

Edit OPC UA settings

Use this procedure to edit OPC UA settings.

1. If necessary, open the IO-Link web interface with the browser using the IP address. Click the “Configuration” tab, and then click the “OPC UA” subtab to access the “OPC UA Settings” page.

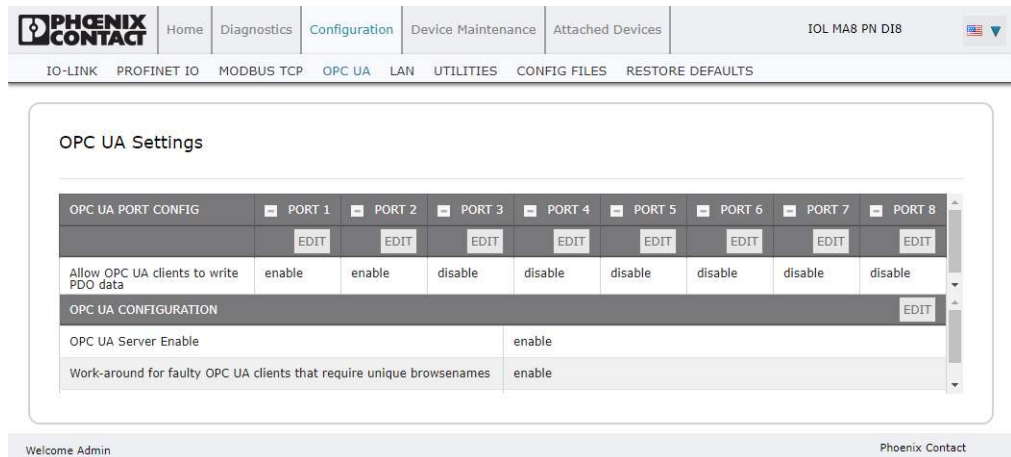

Figure 5-13 “OPC UA Settings” page

2. Click the “EDIT” button for the port or ports to configure.

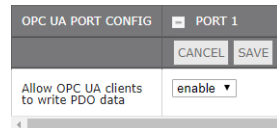

Figure 5-14 Editing a port on the “OPC UA Settings” page



Click the “EDIT” button for all ports to quickly configure all port parameters.

3. Make appropriate selections for the device connected to that port.
4. Click each “EDIT” button and open all ports to quickly configure port parameters. Scroll over to see all editable parameters.
5. Scroll to the top of the page and click the “SAVE” button.
Make sure that the port now displays the “EDIT” button. If it displays the “SAVE” and “CANCEL” buttons, that means that one of the parameters contains an incorrect value. If necessary, scroll down the page, make the needed corrections, and click the “SAVE” button.

OPC UA Settings parameters

The following table provides information about the “OPC UA Settings” page.

Table 5-7 “OPC UA Settings” parameters

Field name	Function
OPC UA Server Enable Default: <i>Disable</i>	This option controls whether or not the OPC UA server runs on the IOL MA8 PN DI8.
Work-around for faulty OPC UA clients that require unique browsenames Default: <i>Disable</i>	Enables an alternative set of browse names where each node’s browse name is unique. Normally only browse paths are required to be unique.
Allow OPC UA clients to write PDO data Default: <i>Disable</i>	Determines whether OPC UA clients are allowed to write PDO data to the IOL MA8 PN DI8 slaves.
Allow OPC UA clients to write ISDU data Default: <i>Disable</i>	Determines whether OPC UA clients are allowed to write ISDU data to the IOL MA8 PN DI8 slaves.

5.2.6 LAN settings

The local area network (LAN) settings may be reviewed or changed.

To view and edit LAN settings:

1. Click the “Configuration” tab, and then click the “LAN” subtab.

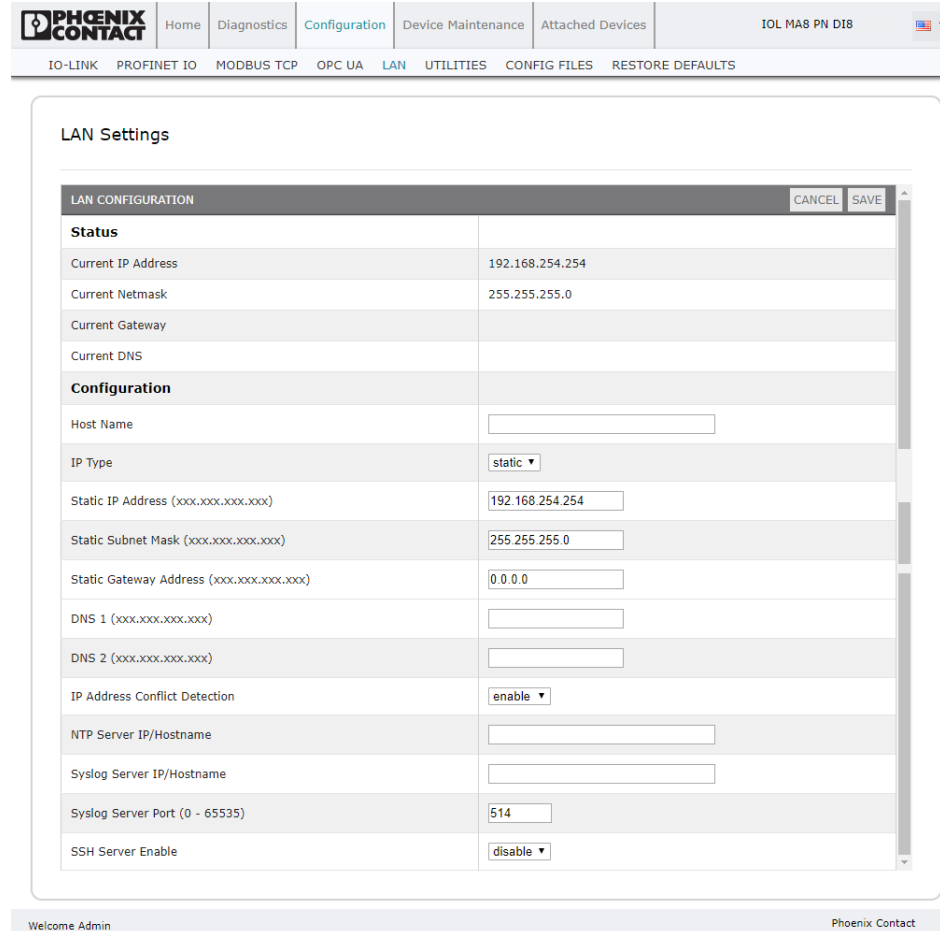

Figure 5-15 “LAN Settings” page

2. Scroll to see all the fields and values.
3. To change a setting, click the “EDIT” button.
A “Caution” message appears.

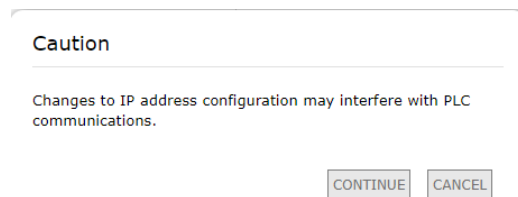

Figure 5-16 “Caution” message

4. Click the “CONTINUE” button to close the message box.
5. Enter the desired values in the appropriate fields.
6. When finished, click the “SAVE” button.

5.2.7 Utilities

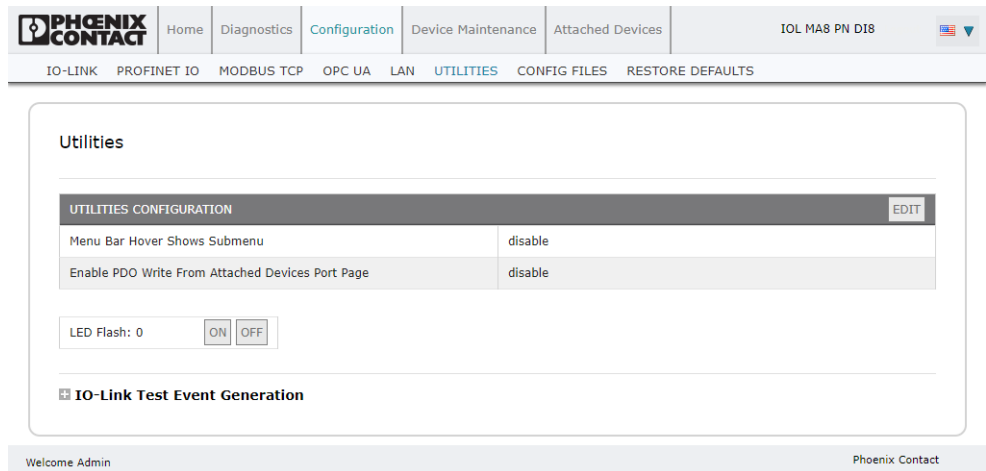

Figure 5-17 “Utilities” page options

The “Utilities” page includes the following options:

- **Menu Bar Hover Shows Submenu:** Select **enable** to display submenus for a category when hovering over the category name. This provides the ability to directly navigate to a subpage under another tab. For example, from the “Home” page you may navigate directly to the IODD files by hovering over the “Attached Devices” tab, and then clicking the “IODD files” subtab.
- **Enable PDO Write From Attached Devices Port Page:** Select **enable** to allow writing PDO data to IO-Link slaves from the “Attached Devices/Port” page in the user interface.



The PDO write will not allow writes if the IOL MA8 PN DI8 has a PLC connection. This should never be enabled in a production environment.

- **LED Flash:** Forces the IO-Link port LEDs on the IOL MA8 PN DI8 to flash, which allows easy identification of a particular unit.
Click the “ON” button to flash the LEDs on the IOL MA8 PN DI8. The LEDs flash until the “OFF” button is clicked.

Enable PDO Write From Attached Devices Port Page

The purpose of this feature is for a non-production type of demonstration of the IOL MA8 PN DI8. Enable this feature to get familiar with IO-Link or if you are commissioning a system and want to be able to test or familiarize yourself with devices. Interact with a PDO device that does not have a PLC connection.



The PDO write will not allow writes if the IOL MA8 PN DI8 has a PLC connection. This should never be enabled in a production environment.

IO-Link test event generator

Use the “Test Event Generator” function to send messages to an IOL MA8 PN D18 port. The generated events are displayed in the “IO-Link Settings” page under the “Last Events” field and the syslog file. This can test a port to verify that it is functioning correctly.

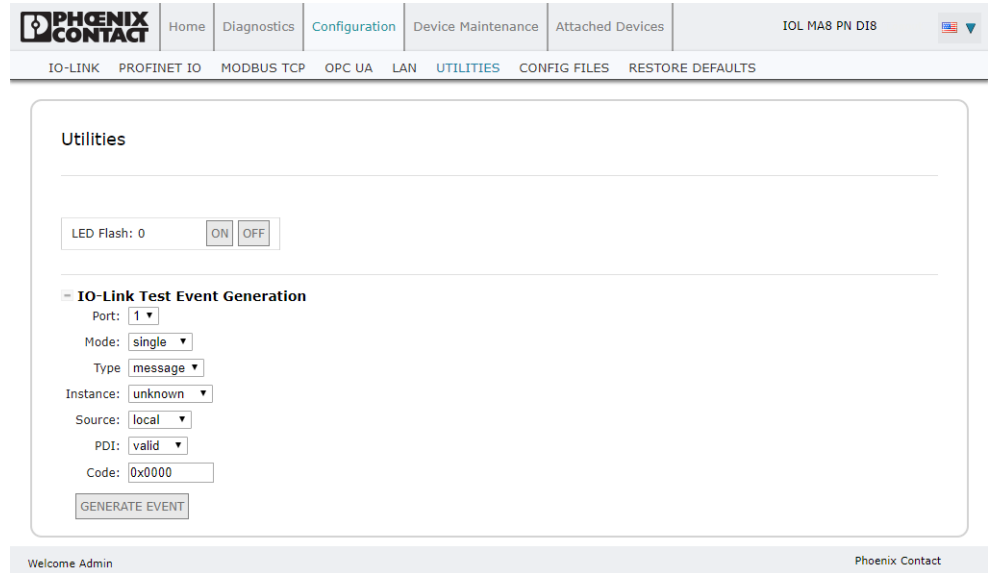

Figure 5-18 “IO-Link Test Event Generation” group expanded

Table 5-8 describes the types of event that can be generated.

Table 5-8 IO-Link Test Event Generator Descriptions

Field name	Function
Port	The port number to send an event.
Mode	This is the first item in the event generated. <ul style="list-style-type: none"> – Single: generates Single in the event. – Coming: generates Active in the event. – Going: generates Cleared in the event.
Type	This is the second item in the event generated. <ul style="list-style-type: none"> – Message: generates Message in the event. – Warning: generates Warning in the event. – Error: generates Error in the event.
Instance	This is the level in which the event is generated. This is not displayed in the generated event. <ul style="list-style-type: none"> – unknown – physical – datalink – applayer – application

Table 5-8 IO-Link Test Event Generator Descriptions

Field name	Function
Source	<p>This is the source in which the event is generated. This is the third item in the generated event.</p> <ul style="list-style-type: none"> - Local: simulation generated from the IOL MA8 PN DI8, which displays as Local in the event. - Remote: simulation of an IO-Link device event, which displays as Device in the generated event.
PDI	<p>This indicates whether to send a valid or invalid PDI, which is not displayed in the generated event.</p> <ul style="list-style-type: none"> - Valid - Invalid
Code	<p>These are the fourth and fifth items in the generated event.</p> <ul style="list-style-type: none"> - 0x0000: Generates a s_pdu_check event - 0x0001: Generates a s_pdu_flow event - 0x0002: Generates a m_pdu_check event - 0x0003: Generates a s_pdu_illegal event - 0x0004: Generates a m_pdu_illegal event - 0x0005: Generates a s_pdu_buffer event - 0x0006: Generates a s_pdu_inkr event - 0x0007: Generates an s_pd_len event - 0x0008: Generates an s_no_pdin event - 0x0009: Generates an s_no_pdout event - 0x000a: Generates an s_channel event - 0x000b: Generates an m_event event - 0x000c: Generates an a_message event - 0x000d: Generates an a_warning event - 0x000e: Generates an a_device event - 0x000f: Generates an a_parameter event - 0x0010: Generates a devicelost event - 0x0011, 13 - 17: Generates an unknown event - 0x0012: Generates a s_desina event

5.2.8 Configuration files

Use the web interface to save or load IOL MA8 PN D18 configuration files.

5.2.8.1 Saving configuration files

The configuration files for the IOL MA8 PN D18 includes all port settings, network settings, and encrypted passwords.

1. Click the “Configuration” tab and then click the “CONFIG FILES” subtab.

PHOENIX CONTACT Home Diagnostics Configuration Device Maintenance Attached Devices IOL MA8 PN D18

IO-LINK PROFINET IO MODBUS TCP OPC UA LAN UTILITIES CONFIG FILES RESTORE DEFAULTS

Load or Save Configuration

Save Configuration

Select data to save:

- IOLM gateway configuration
- Datastorage contents
- IODD files

above data to file

Load Configuration

Select data to load:

- IOLM gateway configuration
- IOLM_network_configuration
- Datastorage contents
- IODD files

Select file to load: No file chosen

Welcome Admin Phoenix Contact

Figure 5-19 “Load or Save Configuration” page

2. Check the box next to the desired files to be saved.
3. Click the “SAVE” button.

The config.dcz file will be saved to the browser’s default location for downloads.

5.2.8.2 Loading configuration files

To load a configuration file on to the IOL MA8 PN D18:

1. Click the “Configuration” tab, and then click the “CONFIG FILES” subtab.

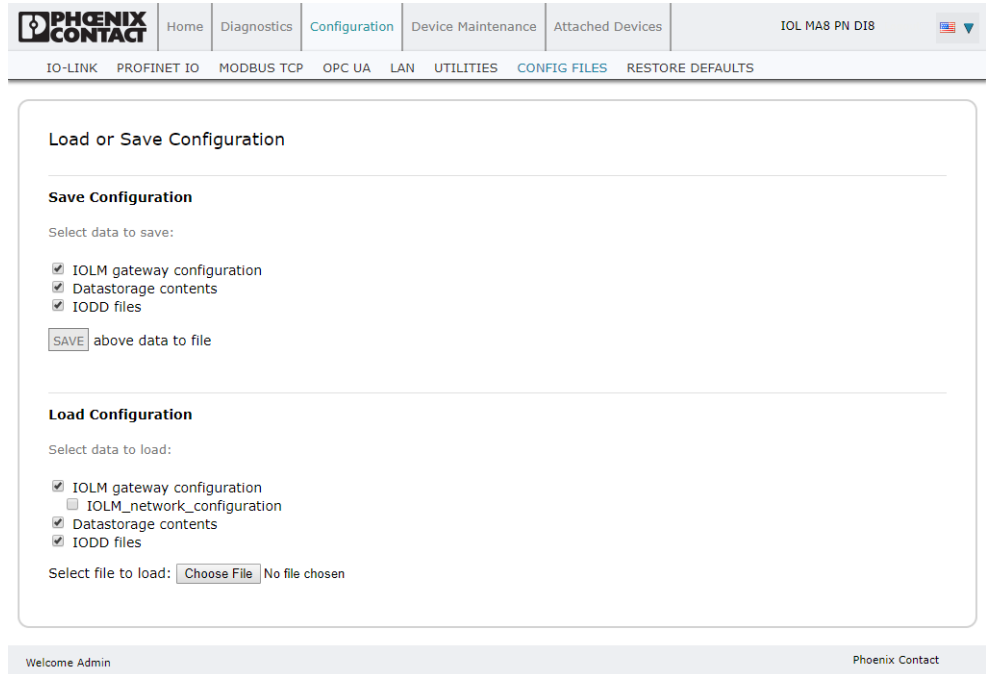

Figure 5-20 Load options on the “Load or Save Configuration” page

2. Click the “Choose File” button and navigate to the configuration file (.dcz extension).
3. Click the “LOAD” button.
4. Click the “OK” button to close the “Configuration Uploaded” message that notifies which configuration parameters loaded.

5.2.8.3 Restore default factory settings

Returns the IOL MA8 PN D18 to factory default values:

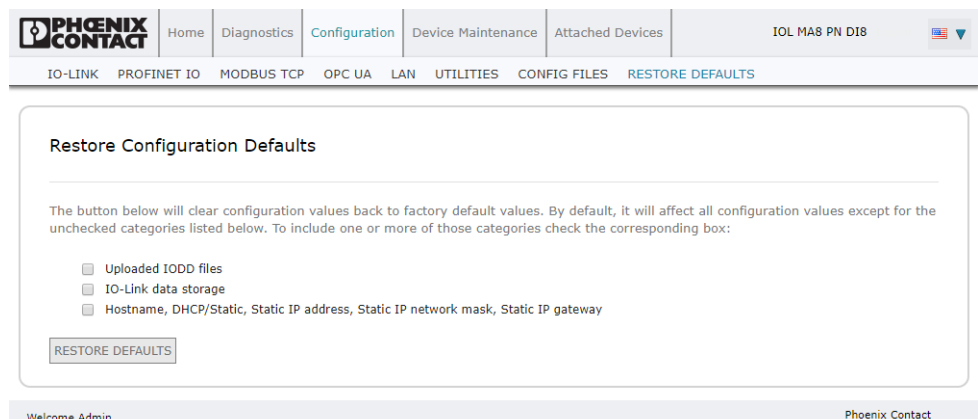

Figure 5-21 “Restore Configuration Defaults” page

In addition to resetting the configuration options to the factory defaults, additional defaults can be reset by checking the appropriate box.

- **Uploaded IODD files:** Removes any user-loaded IODD files.
- **IO-Link data storage:** Removes saved data from IO-Link devices.
- **Hostname, network settings (DHCP/Static, static IP address, static network mask, and static IP gateway):** Removes any stored data in the listed fields.

5.3 Device maintenance

5.3.1 Firmware

The IOL MA8 PN DI8 is loaded with the latest firmware at the factory but may require updated images or application subassemblies to access to the latest features. To view the image and application versions in the IOL MA8 PN DI8, click the “Device Maintenance” tab, and then click the “FIRMWARE” subtab.

The screenshot shows the 'Firmware' page in the Phoenix Contact web manager interface. The page is divided into two main sections: 'IMAGES' and 'APPLICATIONS'. Each section contains a table of components and their versions, with an 'UPDATE' button for each row. Below the tables is an 'Update Application' section with a file upload area and a 'REBOOT' button.

IMAGES	
U-Boot Bootloader	1.24
FPGA	1.00
System - Primary	1.32
System - Backup	1.32
Application Base	1.5.25

APPLICATIONS	
application-manager	1.5.0.3
configuration-manager	1.5.0.4
discovery-protocol	1.5.0.1
ethernetip	1.5.0.023
event-log	1.5.0.2
iolink-driver	1.5.2.12
libiolinkutils	1.5.0.046
modbus	1.5.0.020
opcua-server	1.5.1.11
web-user-interface	1.5.0.34

Update Application

Choose File No file chosen Install REBOOT

Figure 5-22 “Firmware” page

5.3.1.1 Updating images

The upper portion of the “FIRMWARE” page is used to update the IOL MA8 PN D18 images. The lower portion is used to update application subassemblies that are integrated in the Application Base.

Typically, the latest application subassemblies are available in the Application Base image. There may times when a feature enhancement is available in an application subassembly and not yet available in the Application Base image.

Use this procedure to upload images using the “FIRMWARE” page.

1. Download the latest image from phoenixcontact.net/product/1072838.
2. Open a browser and enter the IP address of the IOL MA8 PN D18.
3. Click the “Device Maintenance” tab, and then click the “FIRMWARE” subtab.
4. Click the “UPDATE” button next to the image to be updated.

IMAGES			
U-Boot Bootloader	1.25		<input type="button" value="UPDATE"/>
FPGA	1.00		<input type="button" value="UPDATE"/>
System - Primary	1.32		<input type="button" value="UPDATE"/>
System - Backup	1.32		<input type="button" value="UPDATE"/>
Application Base	1.5.27		<input type="button" value="UPDATE"/>

Figure 5-23 Image update

5. Click the “Choose File” button and navigate to the file location using the “Browse” window. Highlight the image, and click the “Open” button.
6. Click the “Install” button.
7. Click the “CONTINUE” button in the “Update Image” message.
8. When finished, click the “OK” button to close the “Update Image Successful” message.
9. After an image is updated, always click the “REBOOT” button.

5.3.1.2 Updating application subassemblies

Application subassemblies

Application subassemblies are the components of the Application Base image. Application subassemblies have a version number consisting of four segments (for example, 1.3.18.3). The first two values in a subassembly version correspond to the version of the application base assembly for which it was built and tested.

When using the “FIRMWARE” page, an application subassembly can install only if its version number matches that of the installed application base assembly. A subassembly with a version of 1.20.2.4 installs only if the application base version is 1.20.2. It will not install on a device with application base version 1.21.5.

Use this procedure to upload applications using the “FIRMWARE” page.

1. Download the latest application from the phoenixcontact.net/product/1072838.
2. Open a browser and enter the IP address of the IOL MA8 PN D18.
3. Click the “Device Maintenance” tab, and then click the “FIRMWARE” subtab.

- Click the “Choose File” button at the bottom of the page, navigate to the file location using the “Browse” window, and click the “Open” button.

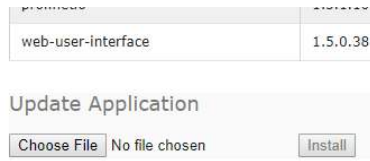

Figure 5-24 Application update

- Click the “Install” button.
- Click the “CONTINUE” button in the “Update Image” message.
- When finished, click the “OK” button to close the “Update Image Successful” message.
- Click the “Reboot” button.



NOTE:

After an application subassembly is updated, always reboot the device.

5.3.2 Accounts

The IOL MA8 PN DI8 is shipped from the factory without passwords. If desired, user accounts may be configured to limit read and write access. See [Table 5-9](#) to see how permissions are granted.

Table 5-9 User privilege descriptions

Page	Admin	Operator	User
Login	Yes	Yes	Yes
Home	Yes	Yes	Yes
Diagnostics - All	Yes	Yes	Yes
Configuration - IO-Link settings	Yes	Yes	View only
Configuration - Digital I/O settings	Yes	Yes	View only
Configuration - Modbus TCP settings	Yes	Yes	View only
Configuration - OPC UA settings	Yes	Yes	View only
Configuration - Network	Yes	View only	No
Configuration - Misc	Yes	Yes	Yes
Configuration - Load/Save	Yes	Yes	View only
Configuration - Clear settings	Yes	No	No
Advanced - Software	Yes	No	No
Advanced - Accounts	Yes	No	No
Advanced - Log Files	Yes	Yes	Yes
Advanced - Licenses	Yes	Yes	Yes

Table 5-9 User privilege descriptions [...]

Page	Admin	Operator	User
Attached Devices - IO-Link device description files	Yes	Yes	View only
Attached Devices - IO-Link device configuration summary	Yes	Yes	View only
Attached Devices - IO-Link device port	Yes	Yes	View only

To set up passwords for the IOL MA8 PN D18:

1. Open the browser and enter the IOL MA8 PN D18 IP address.
2. Click the “Device Maintenance” tab, and then click the “ACCOUNTS” subtab.

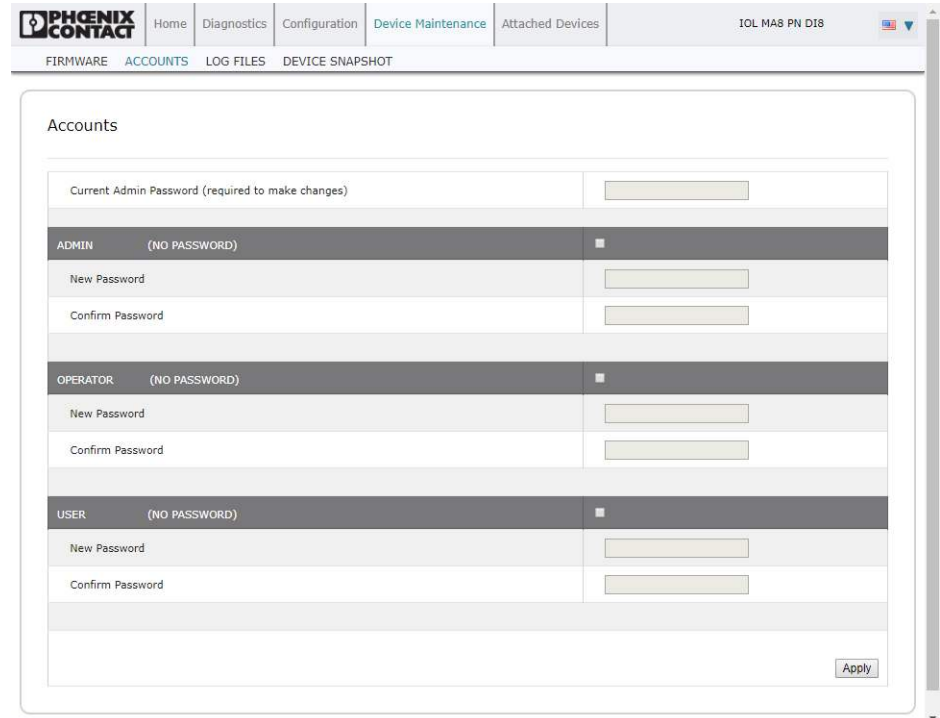

Figure 5-25 “Accounts” page

3. Enter the current administrator password, if an ADMIN account has been configured.
4. Click the checkbox for the desired password level (ADMIN, OPERATOR, or USER).
5. Enter the new password in the appropriate “New Password” and “Confirm Password” fields.
6. Click the “Apply” button. The next time the web manager is opened, the “Login” screen is shown.

5.3.3 Log files

The IO-Link provides five different log files to view, export, or clear:

- syslog (system log) displays line-by-line activity records.
- dmesg displays Linux kernel messages.
- top displays which programs are using most of the memory and CPU.
- ps displays the running programs.
- All log files start up automatically during the startup cycle. Each log file has a size limit of 100 kB.



Typically, log files are intended to be used by Technical Support in the event there is a problem.

5.3.3.1 View a log file

To view a log file:

1. Click the “Device Maintenance” tab and then click the “LOG FILES” subtab.
2. Select the desired file from the “select log file” drop-down menu.

The screenshot shows the Phoenix Contact web manager interface. The top navigation bar includes 'Home', 'Diagnostics', 'Configuration', 'Device Maintenance', and 'Attached Devices'. Below this, there are sub-tabs for 'FIRMWARE', 'ACCOUNTS', 'LOG FILES', and 'DEVICE SNAPSHOT'. The 'LOG FILES' sub-tab is active, and the 'select log file' dropdown menu is set to 'syslog'. The main content area displays the 'syslog' log file, showing a list of system log entries. The entries include timestamps, severity levels, and messages such as 'syslog.info syslogd started: BusyBox v1.26.2', 'kern.notice kernel: klogd started: BusyBox v1.26.2 (2018-01-19 11:01:00 CST)', and 'kern.info kernel: Memory: 64MB = 64MB total'. There are also buttons for 'REFRESH', 'CLEAR', and 'EXPORT'.

Figure 5-26 syslog file displayed on the “Log Files” page

3. Optionally, click the “REFRESH” button to get the latest information.
4. Optionally, export the log file.

5.3.3.2 Export a Log File

To export a log file:

1. Click the “Device Maintenance” tab, and then click the “LOG FILES” subtab.
2. Select the desired file from the “select log file” drop-down menu.

3. Click the "EXPORT" button.
4. The file is saved where your browser downloads files.

5.3.3.3 Clear a log file

Use this procedure to clear a log file.

1. Click the "Device Maintenance" tab, and then click the "LOG FILES" subtab.
2. Select the desired file from the "select log file" drop-down menu.
3. Click the "CLEAR" button.

The log file automatically starts logging the latest information.

5.3.4 Device snapshot

The device snapshot provides a summary of the hardware versions, network settings, and firmware images loaded on the IOL MA8 PN DI8. Additionally, a comprehensive support file may be downloaded to assist when troubleshooting.

1. Click the “Device Maintenance” tab, and then click the “DEVICE SNAPSHOT” subtab.

The screenshot shows the Phoenix Contact web manager interface. The top navigation bar includes tabs for Home, Diagnostics, Configuration, Device Maintenance (selected), and Attached Devices. The user is logged in as IOL MA8 PN DI8. Below the navigation bar, there are sub-tabs for FIRMWARE, ACCOUNTS, LOG FILES, and DEVICE SNAPSHOT (selected). The main content area is titled "Device Snapshot" and includes a "DOWNLOAD" button. The data is organized into three sections: SYSTEM INFO, APPLICATION BASE, and IMAGES.

SYSTEM INFO	
Host Name	?
Serial Number	9660-065535
Model Name	IOL MA8 PN DI8
Hardware Version	99660-6 rev A
Switch Position	000
MAC Address	a8:74:1d:76:df:00
IP Address	192.168.254.254
Subnet Mask	255.255.255.0
Gateway Address	0.0.0.0
IP Type	static
APPLICATION BASE	
application-manager	1.5.0.3
configuration-manager	1.5.0.4
discovery-protocol	1.5.0.1
event-log	1.5.0.2
iolink-driver	1.5.2.13
libiolinkutils	1.5.0.046
modbus	1.5.0.020
opcua-server	1.5.1.13
profinetio	1.5.1.10
web-user-interface	1.5.0.38
IMAGES	
U-Boot	1.25
FPGA	1.00
uImage-Primary	1.32
uImage-Backup	1.32
Applications	1.5.27

At the bottom of the page, there is a "Welcome Admin" message on the left and "Phoenix Contact" on the right.

Figure 5-27 “Device Snapshot” page

2. Scroll to see all the fields and values.
3. If desired, click the “DOWNLOAD” button to download a text file with this information. A file named **supportinfo.txt** is downloaded to the default browser location.

5.4 Attached devices

5.4.1 IODD files

The “Attached Devices” page supports IO-Link Device Description (IODD) file management.

5.4.1.1 IO-Link device description files page

Use the “IO-Link Device Description Files” page to update (upload) and delete IO-Link Device Description (IODD) files associated with this IOL MA8 PN D18. Review the IODD xml file by clicking the IODD FILENAME in the table after loading the IODD file.

Download the appropriate IODD files from the IO-Link device manufacturer.

The IOL MA8 PN D18 provides 15790 kB of space to store IODD files. The IOL MA8 PN D18 includes the following default IODD files that cannot be deleted.

- IODD-StandardDefinitions1.0.1.xml
- IODD-StandardUnitDefinitions1.0.1.xml
- IODD-StandardDefinitions1.1.xml
- IODD-StandardUnitDefinitions1.1.xml

Preparing IODD files to upload

Some IODD zip files contain the xml files and supporting image files for a single product. This type of zip file may be directly uploaded to the IOL MA8 PN D18.

Some IODD zip files contain the files for multiple products.

1. Unzip the package and locate the xml file needed for the IO-Link device.
2. Open the xml file and search for the product ID that identifies the IO-Link device.
3. Zip the xml file along with the supporting images. There are several ways to locate the supporting images:
 - Locate the appropriate images using the xml file.
 - Load only the xml file and the IOL MA8 PN D18 notifies which files are missing. Use the “UPDATE” feature to upload the missing images.
 - Zip the xml with all of the images and the IOL MA8 PN D18 ignores (and does not upload) any unused files and notifies which files did not upload.Image files are not required for IO-Link device configuration.

Uploading IODD files

To upload IODD zip files:

1. Click the “Attached Devices” tab, and then click the “IODD FILES” subtab.

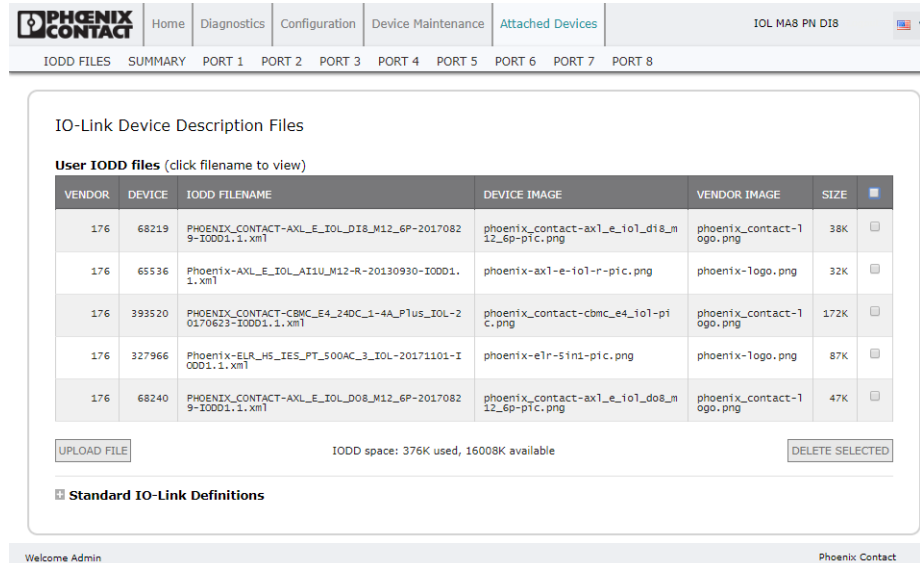

Figure 5-28 “IO-Link Device Description Files” page

2. Click the “UPLOAD FILE” button.



Figure 5-29 Upload options on the “IO-Link Device Description Files” page

3. Click the “CHOOSE FILE” button and browse to the file location.
4. Highlight the zip file, click the “Open” button, and then click the “UPLOAD” button.
5. If necessary, click the “OK” button.



Only images referenced in the xml file load to the IOL MA8 PN D18. Any remaining files are ignored.

If desired, click the file name in the “IODD FILENAME” column to view the xml file.
 Click the hyperlink at the top of the page to view the xml file in the browser.
 If multiple files are listed, check the boxes next to the desired rows, and then click the “UPLOAD” button

6. Verify that the correct xml file is loaded on the “SUMMARY” page.

The IOL MA8 PN D18 provides notification when files are missing. The missing files do not affect the operation of the IO-Link device, but the product image and logo of the IO-Link device manufacturer will not display.

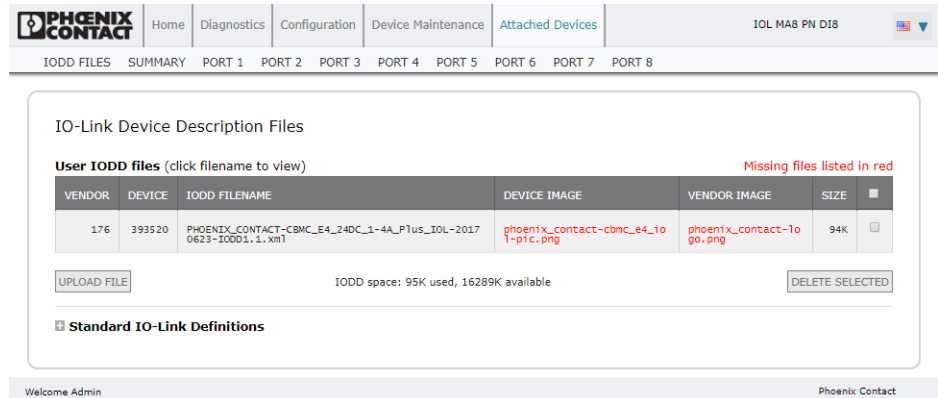

Figure 5-30 Missing files notification on the “IO-Link Device Descriptions Files” page

Deleting IODD files

Use the following procedure to delete an IODD file set from the IOL MA8 PN D18.

1. Click the “Attached Devices” tab, and then click the “IODD FILES” subtab.
2. Check the box in the right-most column of the corresponding row of the IODD file to delete.
3. Click the “DELETE SELECTED” button.
4. Click the “CONTINUE” button to confirm deletion.

5.4.2 IO-Link device configuration summary

The “IO-Link Device Configuration Summary” page provides basic device configuration (device profile) information for ports with valid IO-Link devices attached. The “IO-Link Device Configuration Summary” page retrieves information that resides on the IO-Link device from the manufacturer.

The “IODD Name” field displays the corresponding IODD file for the IO-Link device attached to that port. An empty field indicates that a valid IODD file has not been loaded.

Click the “MORE” button next to each port to review the complete IODD file information on a port-by-port basis or click the desired “PORT” subtab.

Use the following steps to access the “IO-Link Device Configuration Summary” page.

1. Click the “Attached Devices” tab and then the “SUMMARY” subtab.

The screenshot shows the Phoenix Contact web manager interface. At the top, there is a navigation bar with the Phoenix Contact logo and several menu items: Home, Diagnostics, Configuration, Device Maintenance, Attached Devices (selected), and IOL M48 PN DI8. Below the navigation bar, there is a sub-tab bar with options: IODD FILES, SUMMARY (selected), PORT 1, PORT 2, PORT 3, PORT 4, PORT 5, PORT 6, PORT 7, and PORT 8.

The main content area is titled "IO-Link Device Configuration Summary" and contains a table with the following data:

DEVICE SETTINGS	PORT 1	MORE	PORT 2	MORE	PORT 3	MORE	PORT
Vendor Name	Phoenix Contact		Phoenix Contact		Phoenix Contact		
VENDOR	176		176		176		
DEVICE	327966		68240		65536		
Description	Hybrid motor starter		Axioline E digital output device via IO-Link		voltage input		
IO-Link Version	1.1		1.1		1.1		
Hardware Version	1		00		03		
Firmware Version	1.10/1.11		1.01		110		
Baud Rate	230400		230400		230400		
SIO Mode	No		No		No		
Min Cycle Time	30 ms		0 ms		2 ms		
IODD Name	Phoenix-ELR_H5_IES_PT_50_9AC_3_IOL-20171101-IODD1.1.xml		PHOENIX_CONTACT-AXL_E_IOL_D08_M12_6P-20170829-IODD1.1.xml		Phoenix-AXL_E_IOL_A11U_M12-R-20130930-IODD1.1.xml		
Serial Number	1358238023		2033950684		3029032178		

At the bottom of the interface, there is a status bar with "Welcome Admin" on the left and "Phoenix Contact" on the right.

Figure 5-31 “IO-Link Device Configuration Summary” page

The summary page takes several minutes to completely load as each device is queried.

- Click the “MORE” button for the corresponding port to configure the IO-Link device parameters for a specific device. This opens the “IO-Link Device Port *n*” page where *n* is the selected port.

The screenshot shows the Phoenix Contact web interface for the 'IO-Link Device - Port 1' configuration. The page title is 'IO-Link Device - Port 1' with a 'User role menu' dropdown. The interface includes a navigation bar with 'HOME FILES', 'SUMMARY', and 'PORT 1' through 'PORT 8'. The main content area features a table of parameters categorized into 'Identification' and 'Parameter' sections. The 'Identification' section lists parameters like Vendor Name, Vendor Text, Product Name, Product ID, Product Text, Hardware Version, and Firmware Version. The 'Parameter' section lists 'Nominal current 1 setting (0 ... 15)' and 'Application Specific Tag'. Below these are 'Device Access Locks' including 'Parameter (write) Access Lock', 'Data Storage Lock', 'Local Parameterization Lock', and 'Local User Interface Lock'. The status at the bottom indicates 'Port Status: Operational, PDI Valid, PDO Invalid'.

Parameter Name	Index	Subindex	Value	Description	R/W
- Identification					
Vendor Name	16		Phoenix Contact		RO
Vendor Text	17		www.phoenixcontact.com		RO
Product Name	18		ELR H5-IES-PT/500AC-3-IOL		RO
Product ID	19		2908669		RO
Product Text	20		IO-Link/Hybrid-Motorstarter		RO
Hardware Version	22		1		RO
Firmware Version	23		1.10/1.11		RO
- Parameter					
Nominal current 1 setting (0 ... 15)	66				WC
Application Specific Tag	24		IO-Link/Hybrid-Motorstarter		RW
Device Access Locks					
Parameter (write) Access Lock	12	1*	0	0 1	RW
Data Storage Lock	12	2*	0	Same as previous description	RW
Local Parameterization Lock	12	3*	0	Same as previous description	RW
Local User Interface Lock	12	4*	0	Same as previous description	RW

IO-Link Device ISDU Interface - Port 1 Port Status: Operational, PDI Valid, PDO Invalid

Figure 5-32 Details for a selected port on the “IO-Link Device - Port *n*” page

5.4.3 Port parameters

This chapter discusses using the “IO-Link Device - Port *n*” pages to change IO-Link device parameters. Each port has its own numbered page.



Optionally, traditional methods such as PLC interfaces may be used to configure the IO-Link devices.

Port pages overview

Use the “IO-Link Device - Port *n*” page for a port to review and easily edit the IO-Link device configuration or view Process Data.

The screenshot shows the Phoenix Contact web manager interface for the IO-Link Device - Port 1. The page title is "IO-Link Device - Port 1" with a "User role menu" dropdown. The main content is a table of parameters, categorized into Identification and Parameter sections. The table has columns for Parameter Name, Index, Subindex, Value, Description, and R/W. Below the table, there is a status bar indicating "IO-Link Device ISDU Interface - Port 1" and "Port Status: Operational, PDI Valid, PDO Invalid".

Parameter Name	Index	Subindex	Value	Description	R/W
- Identification					
Vendor Name	16		Phoenix Contact		RO
Vendor Text	17		www.phoenixcontact.com		RO
Product Name	18		ELR H5-IES-PT/500AC-3-IOL		RO
Product ID	19		2908669		RO
Product Text	20		IO-Link/Hybrid-Motorstarter		RO
Hardware Version	22		1		RO
Firmware Version	23		1.10/1.11		RO
- Parameter					
Nominal current 1 setting (0 ... 15)	66				WC
Application Specific Tag	24		IO-Link/Hybrid-Motorstarter		RW
Device Access Locks					
Parameter (write) Access Lock	12	1*	0	0 1	RW
Data Storage Lock	12	2*	0	Same as previous description	RW
Local Parameterization Lock	12	3*	0	Same as previous description	RW
Local User Interface Lock	12	4*	0	Same as previous description	RW

IO-Link Device ISDU Interface - Port 1 Port Status: Operational, PDI Valid, PDO Invalid

Figure 5-33 “IO-Link Device - Port *n*” page showing “User role menu” fields

The “User role menu” drop-down menu provides two IO-Link device configuration methods:

- **IO-Link Device Port *n*** (graphical interface): Requires the appropriate IODD file loaded from the IO-Link device manufacturer on to the IOL MA8 PN DI8 (see [“Editing parameters - IO-Link Device - Port *n* graphical interface”](#)).
- **IO-Link Device ISDU Interface - Port *n*** (Indexed Service Data Unit): Can be used with or without IODD files loaded (see [“Editing parameters - IO-Link device ISDU Interface - Port *n*”](#)).
 - The IO-Link device information from the device manufacturer is needed to use the IO-Link Device ISDU Interface since ISDU block index and ISDU subindex numbers are determined by the device manufacturer.

The IO-Link Device - Port *n* graphical interface provides detailed information about the indexes and subindexes. Not all indexes have subindexes. For example, [Figure 5-34](#) shows Index 12 has a subindex of **2**, which is one bit.



The subindex has an asterisk, which indicates that, if using the IO-Link ISDU Interface, a value must be entered.

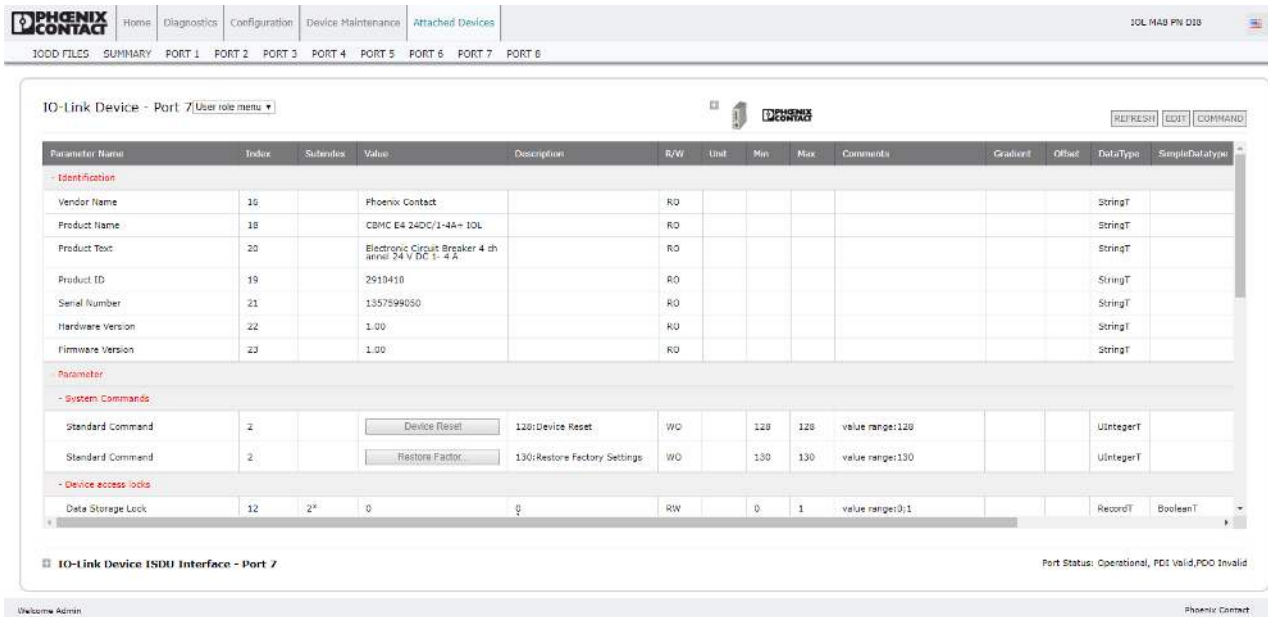

Figure 5-34 “IO-Link Device” page showing index and subindex information

- To access the process data, click the “Process Data” option from the drop-down menu next to the port number.

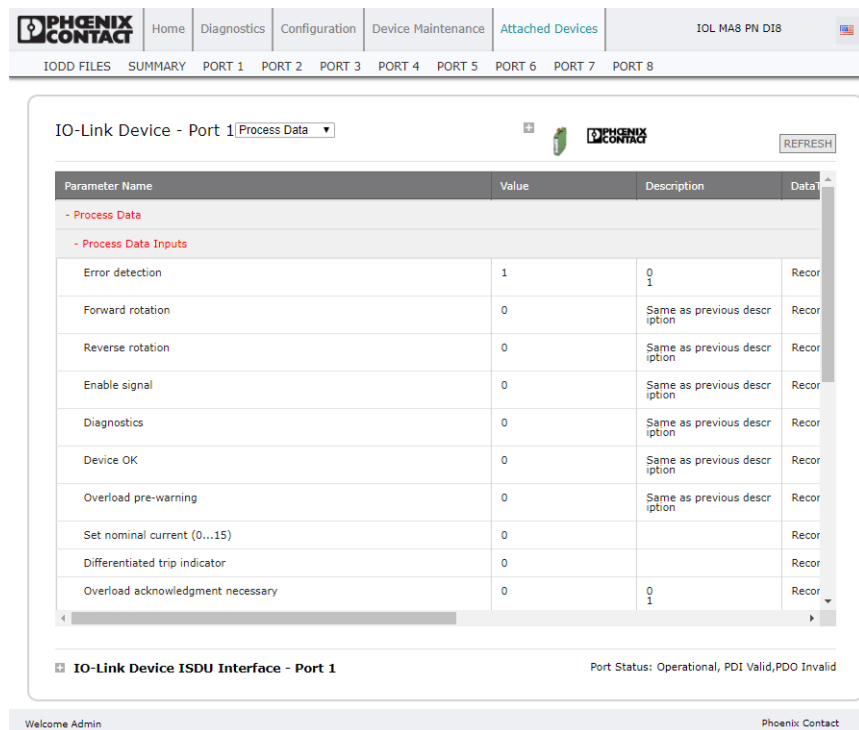

Figure 5-35 Process data on the “IO-Link Device - Port n” graphical interface page

If the correct IODD file is not loaded or the IO-Link device does not support PDO, a message is shown. Click the “OK” button to dismiss it.

Editing parameters - IO-Link Device - Port *n* graphical interface

Use the following procedure to edit IO-Link device parameters using the “Edit” button on the “IO-Link Device - Port *n*” graphical interface page.

1. Verify that the “Automatic Download Enable for Data Storage” option on the “IO-Link Settings” page is not set to **On** as this can cause unreliable results on the corresponding port.
2. If necessary, load the IODD file from the IO-Link device manufacturer.
3. Click the “IO-Link Device - Port *n*” page, and then click the desired port number subtab to display the “User role menu” drop-down menu.

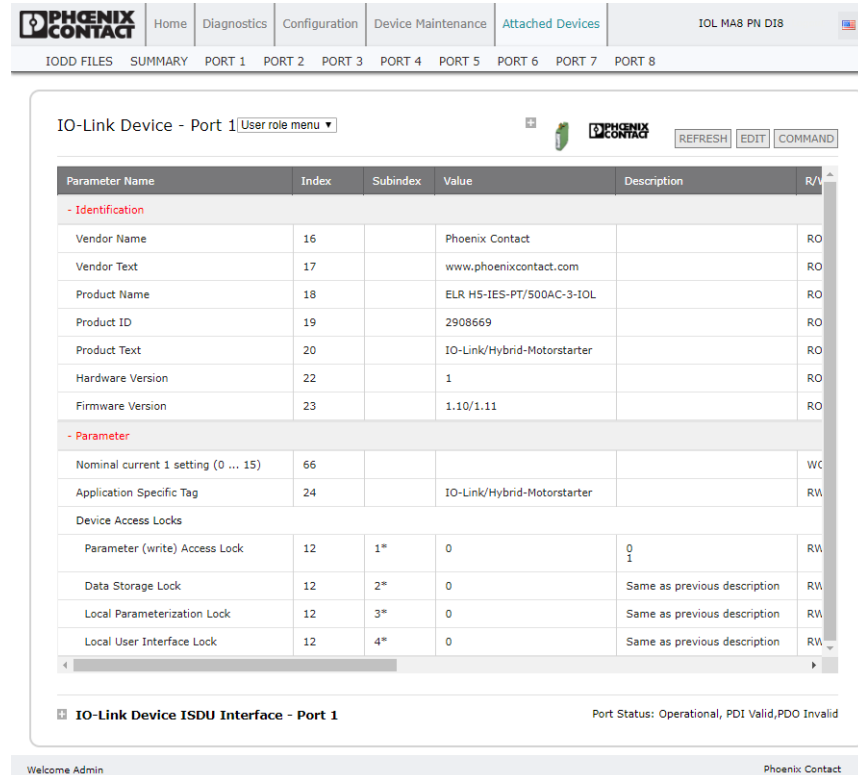

Figure 5-36 “IO-Link Device - Port *n*”

4. Click the “EDIT” button once all the device information is populated in the table.

The screenshot shows the 'IO-Link Device - Port 7' configuration page in the Phoenix Contact web interface. The page has a navigation bar with 'Home', 'Diagnostics', 'Configuration', 'Device Maintenance', and 'Attached Devices'. Below the navigation bar, there are tabs for 'IODD FILES', 'SUMMARY', and 'PORT 1' through 'PORT 8'. The main content area is titled 'IO-Link Device - Port 7' and contains a table of settings. The table has columns for parameter name, address, bit number, a checkbox, a description, and a 'RW' (read/write) indicator. The settings include 'Local Parameterization Lock', 'Local User Interface Lock', 'Channel states after startup', and four channels (Channel 1 to Channel 4). Each channel has a dropdown menu for its state. At the bottom of the table, there is a section for 'Local current adjustment lock enable/disable' with a 'Channel 1' row. The page also features a 'SAVE' button and a 'CANCEL' button. The status bar at the bottom indicates 'Port Status: Operational, PDI Valid, PDO Invalid'.

Parameter Name	Address	Bit	Lock	Description	RW
Local Parameterization Lock	12	3*	<input type="checkbox"/>	Same as previous description	RW
Local User Interface Lock	12	4*	<input type="checkbox"/>	Same as previous description	RW
- Startup settings of channel outputs					
Channel states after startup	3328		<input type="checkbox"/>	0:Load last states from ROM 1:All channels off	RW
- Channel states					
Channel 1	3329	1	<input type="checkbox"/>	0:off 1:on	RW
Channel 2	3329	2	<input type="checkbox"/>	Same as previous description	RW
Channel 3	3329	3	<input type="checkbox"/>	Same as previous description	RW
Channel 4	3329	4	<input type="checkbox"/>	Same as previous description	RW
- Local current adjustment lock enable/disable					
Channel 1	3330	1	<input type="checkbox"/>	0:disabled	RW

Figure 5-37 Editable fields on the “IO-Link Device - Port n” page

5. Use the sliders to scroll as necessary, and then make appropriate parameter changes for the environment.



An IODD file may not contain all IO-Link device settings, depending on the IO-Link device manufacturer.

6. Click the “SAVE” button after editing the parameters.

Resetting IO-Link device parameters to factory defaults

Some manufacturers' IODD files provide the ability to reset the IO-Link device to the factory defaults from the IO-Link device. To reset an IO-Link device:

1. Click the “COMMAND” button (see [Figure 5-36](#)) and locate the “Restore Factory” button.
2. Click the “Restore Factory” or “Load Factory Settings” button (the name of the button is determined by the IO-Link device manufacturer).

The screenshot shows the Phoenix Contact web manager interface. The top navigation bar includes 'Home', 'Diagnostics', 'Configuration', 'Device Maintenance', and 'Attached Devices'. The main content area is titled 'IO-Link Device - Port 7' and contains a table of device parameters and system commands.

Parameter	Index	Sub-index	Value	Access
Product ID	19		2910410	RO
Serial Number	21		1357599050	RO
Hardware Version	22		1.00	RO
Firmware Version	23		1.00	RO
- System Commands				
Standard Command	2		Device Reset	WO
Standard Command	2		Restore Factor...	WO
- Device access locks				
Data Storage Lock	12	2*	<input type="checkbox"/>	RW
Local Parameterization Lock	12	3*	<input type="checkbox"/>	RW

Port Status: Operational, PDI Valid, PDO Invalid

Figure 5-38 Reset Factory IO-Link defaults

3. Click the “OK” button when the “Refresh” message appears.

Editing parameters - IO-Link device ISDU Interface - Port *n*

The “IO-Link Device ISDU Interface - Port *n*” group follows these guidelines:

- If necessary, convert hexadecimal ISDU index numbers to decimal, enter the decimal values in the “ISDU Block Index” and “ISDU Subindex” fields (see [Figure 5-39](#)).
- Enter the hexadecimal value for the IO-Link device parameters.

If the appropriate IODD files have been loaded, use the “Attached Devices - Port *n*” page to determine the index numbers and acceptable values for each parameter.



Not all IO-Link devices settings may be available in an IODD file. IODD files contain only the settings selected by the IO-Link device manufacturer.

If an IODD file is not loaded for an IO-Link device, use the IO-Link device operator’s manual to determine the ISDU indexes.

To edit parameters using the IO-Link Device ISDU Interface - Port:

1. Verify that the “Automatic Download Enable for Data Storage” option on the “IO-Link Settings” page is not set to **On** (see “IO-Link configuration” on page 31), as this can cause unreliable results on the corresponding port.
2. Click the “Expand” (+) button next to the “IO-Link Device ISDU Interface - Port *n*” group to open the interface.

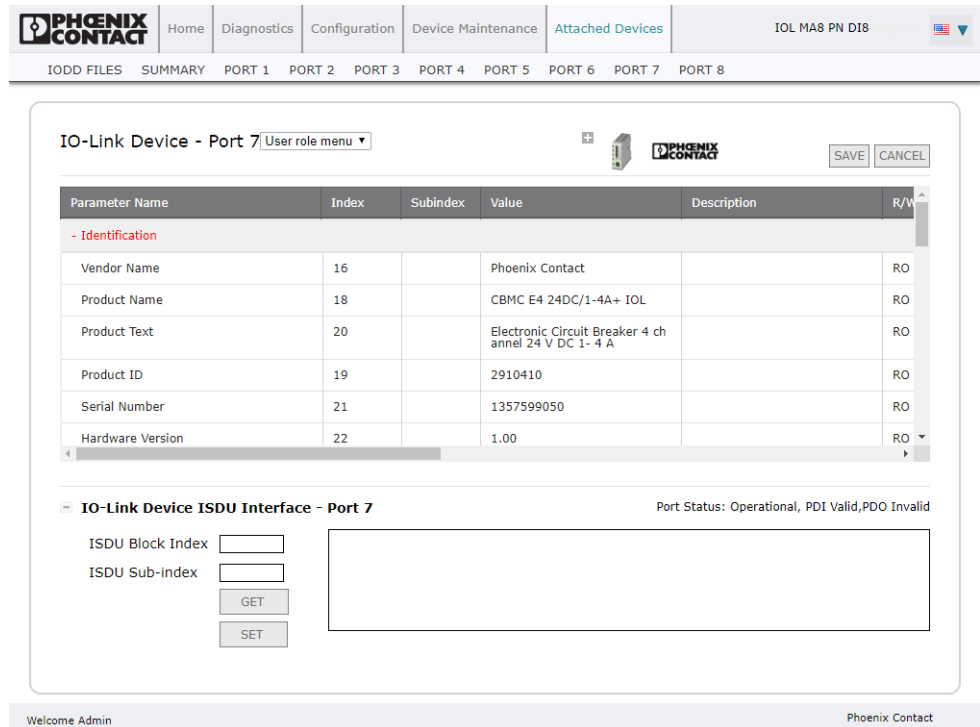

Figure 5-39 “IO-Link Device ISDU Interface - Port *n*” group expanded

3. Enter the number, in decimal form, in the “ISDU Block Index” field.
4. If applicable, enter the number, in decimal form, in the “ISDU Subindex” field.
5. Edit the parameter (hex), and then click the “SET” button.
The “SET” button sends the value to the IO-Link device.
After successfully changing a parameter, the IOL MA8 PN DI8 responds with a “Command executed” notification. This message means that the IO-Link device defines the entry as an invalid setting and indicates that the IO-Link device cannot read the specified ISDU Block Index and Subindex values.
The “GET” button retrieves the parameter value in hex from the IO-Link device.
6. Verify that a “Command executed” message returns.
7. Optionally, if the IODD file is loaded, click the “REFRESH” button to verify changes.

6 Troubleshooting

6.1 Troubleshooting

Before contacting technical support, try the following:

- Check to make sure LEDs are not reporting an issue (see [Table 6-1](#)).
- Verify that the network IP address, subnet mask, and gateway are correct and appropriate for the network. Make sure that the IP address programmed into the IO-Link matches the unique reserved IP configured address assigned by the system administrator.
 - If using DHCP, the host system needs to provide the subnet mask. The gateway is optional and is not required for a purely local network.
 - Verify that the Ethernet hub and any other network devices between the system and the IOL MA8 PN DI8 are powered up and operating.
- Verify that the correct types of cables are used on the correct connectors and that all cables are connected securely.
- Disconnect and re-connect the IO-Link device, or optionally, use the “IO-Link Configuration” page (see [“IO-Link configuration” on page 31](#)) to reset the port, and then set the Port Mode back to IO-Link.
- Reboot or power cycle the IOL MA8 PN DI8. Use the “Firmware” page (see [“Firmware” on page 53](#)) to reboot the IOL MA8 PN DI8.
- Verify that the Port Mode matches the device; for example, IO-Link, Digital In, Digital Out, or Reset (port is disabled).
- If receiving an error that indicates a hardware fault, check the “IO-Link Diagnostics” page (see [“IO-Link diagnostics” on page 19](#)) for the port experiencing the fault.
 - Check the settings for the “Automatic Upload Enable” and “Automatic Download Enable” options. If the Vendor ID or Device ID of the attached device does not match, a hardware fault is generated.
 - Make sure, if the port contains data storage, that the Vendor ID and Device ID match the device attached to the port. If they do not, clear the data storage or move the device to another port.
 - Check the Device Validation and Data Validation settings. If the attached device does not meet these settings, a hardware fault is issued.
- Open the IO-Link interface and review the various Diagnostic pages to locate a problem.
- If a spare is available, try replacing the IOL MA8 PN DI8.

6.2 Status LEDs

The IOL MA8 PN DI8 features LEDs to indicate the status of the device, IO-Link communication, and I/O.

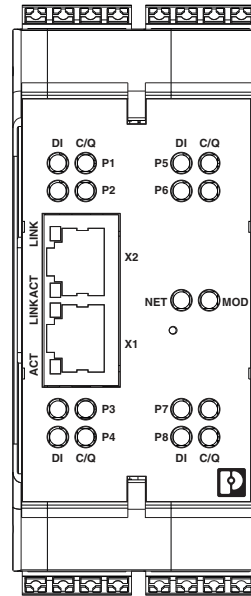

Figure 6-1 IOL MA8 PN DI8 LEDs



Upon power up, the NET and MOD LED stay solid red until the IOL MA8 PN DI8 is fully functional.

Table 6-1 LED indication

LED name	Status	Indication
MOD (Module Status)	Off	No errors or there is no PLC connection
	Flashing green/red	Self-test
	Flashing green	Standby or not configured
	Solid green	Normal operation
	Flashing red	One or more errors detected when NET is off Fatal error when NET LED is also flashing red
	Solid red	Maintenance required
NET (Network Status)	Off	No PLC connection
	Flashing green/red	Self test
	Flashing green	An IP address is configured, but no connections are established
	Solid green	PLC connection established
	Flashing red	Fatal error when MOD LED is also flashing red
	Solid red	Duplicate IP address on network

Table 6-1 LED indication

LED name	Status	Indication
C/Q	Off	SIO mode - signal is low or disabled
	Solid amber	SIO mode - signal is high
	Flashing red	Hardware fault. Ensure that configured IO-Link settings on the port do not conflict with the attached device. Verify that: <ul style="list-style-type: none"> - Automatic Upload and/or Download is enabled and it is not the same device. - Device Validation Mode is enabled and it is not the correct device. - Data Validation Mode is enabled but there is an error.
	Solid red	PDI of the attached IO-Link device is invalid.
	Solid green	An IO-Link device is connected and communicating.
	Flashing green	Searching for IO-Link devices
DI (Digital Input)	Off	DI signal is low or disconnected
	Solid amber	DI signal is high
Ethernet ports	Solid green	A link is established
	Flashing amber	Data transfer activity

A Technical appendix

A 1 Modbus TCP interface

The IOL MA8 PN DI8 provides a slave-mode Modbus TCP interface that provides read access to the Process Data Input (PDI) and Process Data Output (PDO) data blocks for each IO-Link port.



See [“Modbus TCP configuration” on page 40](#) for process data block descriptions.

- Write access to the PDO data block for each IO-Link port
- Write access to send ISDU requests to each IO-Link port
- Read access to ISDU responses from each IO-Link port
- Read access to the port information block for each IO-Link port

A 1.1 Modbus TCP function codes

This table shows the supported Modbus TCP function codes.

Table A-1 Function codes

Message type	Function codes	Maximum message size
Read holding registers	3	250 bytes (125 words)
Write single register	6	2 bytes (1 word)
Write multiple registers	16 (10 hex)	246 bytes (123 words)
Read/Write holding registers	23 (17 hex)	Write: 242 bytes (121 words)

A 2 Modbus TCP address definitions

The address definitions for the Modbus TCP interface are shown in the following tables using base 1 addressing.

Table A-2 Modbus TCP address definitions

	Port 1	Port 2	Port 3	Port 4	Port 5	Port 6	Port 7	Port 8	Access	Length
Multiple Port PDI data block	1000	2000	3000	4000	5000	6000	7000	8000	Read only	Configurable per port
Port Specific PDI data block	1001	2001	3001	4001	5001	6001	7001	8001	Read only	Configurable per port
Multiple Port PDO data block	1050	2050	3050	4050	5050	6050	7050	8050	Read/Write	Configurable per port
Port Specific PDO data block	1051	2051	3051	4051	5051	6051	7051	8051	Read/Write	Configurable per port
Receive ISDU Response	1101	2101	3101	4101	5101	6101	7101	8101	Read only	4 to 125 words
Transmit ISDU Request	1301	2301	3301	4301	5301	6301	7301	8301	Write only	4 to 123 words
Port information block (Continuous block)										
Vendor Name	1501	2501	3501	4501	5501	6501	7501	8501	Read only	64 characters (32 words)
Vendor Text	1533	2533	3533	4533	5533	6533	7533	8533	Read only	64 characters (32 words)
Product Name	1565	2565	3565	4565	5565	6565	7565	8565	Read only	64 characters (32 words)
Product ID	1597	2597	3597	4597	5597	6597	7597	8597	Read only	64 characters (32 words)
Product Text	1629	2629	3629	4629	5629	6629	7629	8629	Read only	64 characters (32 words)
Serial Number	1661	2661	3661	4661	5661	6661	7661	8661	Read only	16 characters (8 words)
Hardware revision	1669	2669	3669	4669	5669	6669	7669	8669	Read only	64 characters (32 words)
Firmware revision	1701	2701	3701	4701	5701	6701	7701	8701	Read only	64 characters (32 words)
Device PDI length	1733	2733	3733	4733	5733	6733	7733	8733	Read only	1 word
Device PDO length	1734	2734	3734	4734	5734	6734	7734	8734	Read only	1 word

B Appendixes

B 1 List of figures

Section 2

Figure 2-1:	IOL MA8 PN DI8 structure	5
Figure 2-2:	Typical system overview	6

Section 3

Figure 3-1:	DIN rail mounting	7
Figure 3-2:	DIN rail removal	7
Figure 3-3:	Single power supply connection	9
Figure 3-4:	Redundant power supply connection	9
Figure 3-5:	SIO connection	10

Section 4

Figure 4-1:	GUI terminology	13
Figure 4-2:	“Login” screen	14
Figure 4-3:	“Home” page	15

Section 5

Figure 5-1:	“IO-Link Diagnostics” page	18
Figure 5-2:	“IO-Link Diagnostics” page	19
Figure 5-3:	“PROFINET IO Diagnostics” page	22
Figure 5-4:	“Modbus TCP Diagnostics” page	25
Figure 5-5:	The “OPC UA Diagnostics” page	28
Figure 5-6:	“IO-Link Diagnostics” page	29
Figure 5-7:	“IO-Link Settings” page	31
Figure 5-8:	Editing a port on the “IO-Link Settings” page	32
Figure 5-9:	“IO-Link Diagnostics” page indicating incorrect sensor connection	38
Figure 5-10:	“PROFINET IO Settings” page	39
Figure 5-11:	“Modbus TCP Settings” page	40
Figure 5-12:	Editing a port on the “Modbus TCP Settings” page	41
Figure 5-13:	“OPC UA Settings” page	45
Figure 5-14:	Editing a port on the “OPC UA Settings” page	45

Figure 5-15: “LAN Settings” page 47

Figure 5-16: “Caution” message 47

Figure 5-17: “Utilities” page options 48

Figure 5-18: “IO-Link Test Event Generation” group expanded 49

Figure 5-19: “Load or Save Configuration” page 51

Figure 5-20: Load options on the “Load or Save Configuration” page 52

Figure 5-21: “Restore Configuration Defaults” page 52

Figure 5-22: “Firmware” page 53

Figure 5-23: Image update 54

Figure 5-24: Application update 55

Figure 5-25: “Accounts” page 56

Figure 5-26: syslog file displayed on the “Log Files” page 57

Figure 5-27: “Device Snapshot” page 59

Figure 5-28: “IO-Link Device Description Files” page 61

Figure 5-29: Upload options on the “IO-Link Device Description Files” page 61

Figure 5-30: Missing files notification on the “IO-Link Device Descriptions Files”
page 62

Figure 5-31: “IO-Link Device Configuration Summary” page 63

Figure 5-32: Details for a selected port on the “IO-Link Device - Port *n*” page 64

Figure 5-33: “IO-Link Device - Port *n*” page showing “User role menu” fields 65

Figure 5-34: “IO-Link Device” page showing index and subindex information 66

Figure 5-35: Process data on the “IO-Link Device - Port *n*” graphical interface
page 66

Figure 5-36: “IO-Link Device - Port *n*” 67

Figure 5-37: Editable fields on the “IO-Link Device - Port *n*” page 68

Figure 5-38: Reset Factory IO-Link defaults 69

Figure 5-39: “IO-Link Device ISDU Interface - Port *n*” group expanded 70

Section 6

Figure 6-1: IOL MA8 PN D18 LEDs 72

B 2 List of tables

Section 1

Table 1-1:	Open-source licenses.....	4
------------	---------------------------	---

Section 2

Table 2-1:	IOL MA8 PN D18 structure	5
------------	--------------------------------	---

Section 3

Table 3-1:	Power supply port connections.....	10
------------	------------------------------------	----

Section 5

Table 5-1:	“IO-Link Diagnostics” page field descriptions	20
Table 5-2:	“PROFINET IO Diagnostics” page field descriptions	23
Table 5-3:	“Modbus/TCP Diagnostics” page field description.....	26
Table 5-4:	Port status and IO-Link state description	30
Table 5-5:	“IO-Link Settings” page parameters.....	33
Table 5-6:	“Modbus TCP Settings” parameters	42
Table 5-7:	“OPC UA Settings” parameters.....	46
Table 5-8:	IO-Link Test Event Generator Descriptions	49
Table 5-9:	User privilege descriptions	55

Section 6

Table 6-1:	LED indication	72
------------	----------------------	----

Appendix A

Table A-1:	Function codes	75
Table A-2:	Modbus TCP address definitions.....	76

Please observe the following notes

General terms and conditions of use for technical documentation

Phoenix Contact reserves the right to alter, correct, and/or improve the technical documentation and the products described in the technical documentation at its own discretion and without giving prior notice, insofar as this is reasonable for the user. The same applies to any technical changes that serve the purpose of technical progress.

The receipt of technical documentation (in particular user documentation) does not constitute any further duty on the part of Phoenix Contact to furnish information on modifications to products and/or technical documentation. You are responsible to verify the suitability and intended use of the products in specific application, in particular with regard to observing the applicable standards and regulations. All information made available in the technical data is supplied without any accompanying guarantee, whether expressly mentioned, implied or tacitly assumed.

In general, the provisions of the current standard Terms and Conditions of Phoenix Contact apply exclusively, in particular as concerns any warranty liability.

This manual, including all illustrations contained herein, is copyright protected. Any changes to the contents or the publication of extracts of this document is prohibited.

Phoenix Contact reserves the right to register its own intellectual property rights for the product identifications of Phoenix Contact products that are used here. Registration of such intellectual property rights by third parties is prohibited.

Other product identifications may be afforded legal protection, even where they may not be indicated as such.

How to contact us

Internet

Up-to-date information on Phoenix Contact products and our Terms and Conditions can be found on the Internet at:

phoenixcontact.com

Make sure always use the latest documentation.

It can be downloaded at:

phoenixcontact.net/products

Subsidiaries

If there are any problems that cannot be solved using the documentation, please contact Phoenix Contact subsidiary.

Subsidiary contact information is available at phoenixcontact.com.

Published by

PHOENIX CONTACT GmbH & Co. KG

Flachsmarktstraße 8

32825 Blomberg

GERMANY

PHOENIX CONTACT Development and Manufacturing, Inc.

586 Fulling Mill Road

Middletown, PA 17057

USA

Should have any suggestions or recommendations for improvement of the contents and layout of our manuals, please send comments to:

tecdoc@phoenixcontact.com