



# Zentri AMW006 / AMW106 Data Sheet



## Disclaimer

While the information provided in this document is believed to be accurate, it is under development and Zentri reserves the right to make changes without further notice to the product described herein to improve reliability, function, or design, and makes no guarantee or warranty concerning the accuracy of said information, nor shall it be responsible for any loss or damage of whatever nature resulting from the use of, or reliance upon, such information. Zentri makes no warranties of any kind, whether express, implied or arising by custom or course of trade or performance, and specifically disclaims the implied warranties of title, non-infringement, merchantability, or fitness for a particular purpose.

No part of this document may be copied, reproduced, stored in a retrieval system, or transmitted, in any form or by any means, electronic, mechanical, photographic, or otherwise, or used as the basis for manufacture or sale of any items without the prior written consent of Zentri.

## Trademarks

Zentri and the Zentri logo are trademarks of Zentri. Other trademarks in this document belong to their respective owners.

© 2014-2017 Zentri.

All rights reserved.

Document Number: ADS-MWx06-109R

Release Date: May 18, 2017

## Contact

<https://www.zentri.com/contact-us/>

## About this User Guide

This document provides information on the AMWx06 802.11b/g/n Wi-Fi networking module from Zentri.

Modules covered by this datasheet include:

AMWx06 Rev 6

Further information about ZentriOS is available from:

<http://docs.zentri.com>

## Organization

This document is organized into the following sections:

1	General Description .....	1
2	Block Diagram .....	2
3	Electrical Specifications.....	3
4	WLAN RF Specifications.....	5
5	Pinout and Signal Descriptions.....	7
6	Design Guidelines.....	9
7	Regulatory Certification .....	15
8	Packaging, Handling and Storage, RoHS .....	22
9	Ordering Information .....	25
10	Revision History & Glossary.....	26
11	References .....	27

## Features

- Self-contained ultra-low power Wi-Fi module with microcontroller and support for ZentriOS-W firmware (AMW006/AMW106) and ZentriOS-WZ firmware (AMW106), including industry standard SSL/TLS secure TCP/IP network stack.
- Integrated SPI-serial flash for software upgrades and user accessible read/write file system

### Wi-Fi

- Cypress single band 2.4GHz IEEE 802.11b/g/n 1x1 Wi-Fi transceiver
- Includes support for all Wi-Fi security modes including Open, WEP, WPA, and WPA2-PSK

### Microprocessor

- ARM Cortex® M4 based microprocessor
- AMW006: operates up to 84MHz core frequency
- AMW106: operates up to 100MHz core frequency

### RAM

- AMW006: 96 KB
- AMW106: 128 KB

### Interfaces\*

- UART: 2 x 4-wire up to 10.5Mbit/s
- SPI : SPI-Master (42Mbit/s), SPI-Slave (21Mbit/s)
- GPIO: Up to 21 GPIOs (overlaid with peripherals)
- A/D converter: 9 channel input, 12-bit resolution, 2.4MSPS sampling in single-shot or scan mode
- PWM: Up to 14 PWM outputs
- Wake-up: Wake pin for ultra-low power operation
- Two external antennas for diversity and improved range

*\*Some interfaces share module pins*

## Operational & Radio

- Single operating voltage : 3.3V (typical)
- All I/O pins are +5V tolerant
- Operational Temperature Range: -30°C to +85°C
- Size : 20.3 x 15.2 x 2.7mm (0.80" x 0.60" x 0.11")
- Weight : 0.07 oz (2g)
- Current consumption @ 3.3V, 25°C
  - VBAT : 0.97µA (with 32k RTC)
  - Standby : 2.8µA (3.8uA with 32k RTC)
  - Stop : 10µA with RAM retention (113µs wake)
  - Wi-Fi Powersave : 0.77mA (DTIM = 3)
  - Active receive : 5.7mA @ 1Mbit/s UDP
- Active transmit : 11.4mA @ 1Mbit/s UDP
- Maximum RF transmit power
  - 802.11b/g : +18 dBm
  - 802.11n : +14 dBm
- Minimum Receive sensitivity
  - 802.11b/g : -94 dBm
  - 802.11n : -86 dBm
- Sustained TCP throughput : 10 Mbit/s

## Applications

- Industrial, M2M and Home Automation
  - Environmental monitoring
  - Energy monitoring
  - Wireless sensing, remote data logging
  - HVAC, power, light, & thermostat control
  - Appliance control
- Security
  - Cameras, Doors/Window monitoring
  - Alarms, Smoke Detectors
  - Door and entry control
- Health & Fitness
  - Fitness Equipment
  - Home health monitoring e.g. weight scales
- Consumer
  - Audio, Toys, Robots

## ZentriOS-W/ZentriOS-WZ Firmware Features

The ZentriOS-W/ZentriOS-WZ firmware supplied with the AMWx06 provides a wide range of features beyond the underlying hardware, and supports application development via its command API.

For complete documentation of ZentriOS-W, see:

<https://docs.zentri.com/zentrios/w/latest/>

The AMW106 supports ZentriOS-WZ firmware, which adds support for developing ZentriOS apps (ZAPs).

For complete documentation of ZentriOS-WZ, see:

<https://docs.zentri.com/zentrios/wz/latest/>

### Software APIs

- [ZentriOS-W command API](#)
- [ZentriOS-WZ command API](#)
- [ZentriOS-WZ SDK and native API](#)

### Interfaces

- Serial (UART, remote terminal)
- SoftAP and WLAN client (concurrent)
- I2C master
- SPI master

### Servers

- TCP/TLS, UDP, HTTP(S), DHCP, DNS
- HTTP(S) Server with RESTful API and Websockets
- Fully customizable mobile responsive Web application with JavaScript and Python libraries

### Clients

- TCP/TLS, UDP, NTP, Secure-SMTP, DHCP, DNS
- HTTP(S) client
- Websocket client

### Setup

- Multiple Wi-Fi setup options, including via serial command and Web setup with SoftAP

### Peripherals and Sensors

- GPIOs for control, indication and monitoring
- I2C-master API for interfacing to external peripherals
- SPI-master API for interfacing to external peripherals
- Automated broadcast and streaming of sensor data
- Local caching of sensor data

### Update and Recovery

Wireless OTA (Over-the-Air) update to remote manage firmware using the Zentri DMS (Device Management Service)

### System Management

- System configuration and monitoring via setting and getting a wide range of variables
- Configurable power states
- Sleep/wake timers

### File System

- Read/write file system with appendable log files
- Storage of large files
- Optional additional bulk serial flash
- HTTP download to file system, HTTP upload from file system

## Contents

1	General Description .....	1	7.1.3	Approved External Antenna Types	16	
2	Block Diagram .....	2	7.1.4	Further Information .....	16	
3	Electrical Specifications.....	3	7.2	Canada .....	17	
3.1	Absolute Maximum Ratings.....	3	7.2.1	Labeling and User Information	Requirements.....	17
3.2	Recommended Operating Conditions ...	3	7.2.2	External Antenna Types.....	18	
3.2.1	DC Operating Conditions.....	3	7.2.3	Further Information .....	18	
3.2.2	Environmental Conditions.....	4	7.3	Europe.....	18	
3.3	Power Consumption .....	4	7.3.1	Labeling and User Information	Requirements.....	19
3.4	32kHz Crystal .....	4	7.3.1	External Antenna Requirements ..	19	
4	WLAN RF Specifications .....	5	7.3.2	Further Information .....	19	
4.1	Summary WLAN Specifications.....	5	7.4	Australia .....	20	
4.2	WLAN Receiver Specifications .....	5	7.4.1	External Antenna Requirements ..	20	
4.3	WLAN Transmitter Specifications .....	6	7.4.2	Further Information .....	20	
5	Pinout and Signal Descriptions .....	7	7.5	New Zealand .....	20	
5.1	Pinout.....	7	7.5.1	External Antenna Requirements ..	20	
5.2	Pin Description.....	7	7.5.2	Further Information .....	21	
6	Design Guidelines.....	9	7.6	Japan .....	21	
6.1	Recommended PCB Footprint .....	9	8	Packaging, Handling and Storage, RoHS .....	22	
6.2	Routing Recommendations .....	10	8.1	Packaging .....	22	
6.3	Soldering Information.....	11	8.2	Handling & Storage .....	22	
6.4	Module Photograph.....	12	8.3	RoHS Directive .....	22	
6.5	External Antennas.....	12	8.4	Tape and Reel Specifications .....	23	
6.5.1	PCB Trace Antenna.....	12	8.5	Cut Tape and Reel Quantity .....	24	
6.5.2	Wire Antenna .....	12	9	Ordering Information .....	25	
1.1.1	Chip Antenna.....	12	9.1	Ordering an Unspecified ZentriOS	Version 25	
6.5.3	Monopole Antenna .....	13	9.2	Ordering a Specific ZentriOS Version or a	Custom Firmware Version .....	25
6.6	Application Examples.....	14	10	Revision History & Glossary.....	26	
6.6.1	Operation using ZentriOS.....	14	10.1	Revision History .....	26	
7	Regulatory Certification .....	15	10.2	Glossary.....	26	
7.1	United States .....	15	11	References.....	27	
7.1.1	Labeling and User Information	Requirements .....				
7.1.2	RF Exposure.....	16				



# 1 General Description

The AMW006 and AMW106 modules from Zentri combine a microcontroller with a BCM43362 Wi-Fi device to provide an advanced stand-alone Wi-Fi and networking solution.

The term **AMWx06** refers to both modules.

An integrated module avoids difficult RF layout and enables designers to rapidly embed Wi-Fi and secure networking functionality into virtually any device.

The ZentriOS serial-to-Wi-Fi application, pre-programmed into all modules, may be used to fast-track module integration into end-products.

With dimensions of just 20.3mm x 15.2mm and a wide temperature range, the module is suitable for integration into most embedded applications.

The Wi-Fi device from Cypress includes an integrated RF transmit power amplifier and provides superior Wi-Fi performance and full compatibility with all 2.4GHz 802.11b/g/n Wi-Fi networks. Connections for two external antennas provide applications with maximum radio range and mechanical design flexibility.

The microprocessor is based on a high-performance ARM® 32-bit Cortex™-M4.

The AMW006/AMW106 microcontroller core operates at a frequency up to 84/100MHz providing up to 125 DMIPS or 1.25 DMIPS/MHz (Dhrystone 2.1).

The AMW006 has 96KB of RAM.

The AMW106 has 128KB of RAM.

The AMWx06 module offers extensive I/O and peripheral interfaces listed below, and provides additional interface combinations by leveraging multiplexing and alternate function capabilities.

- 2 x 4-Wire UART interfaces
- 2 x SPI interfaces (1 master, 1 slave)
- 21 x GPIOs
- 9 x 12-bit A/D converters
- 14 x PWM outputs
- 1 x ultra-low power wake input

The module is powered by a 3.3V power supply, a separate WLAN power supply pin is provided to minimize noise coupling into the WLAN subsystem.

Various powersave modes offer ultra-low power operation. Wake from low power sleep mode is possible using IO pins or the internal real-time clock, and wake from ultra-low power standby mode is achieved using the dedicated wake pin.

The module incorporates a 32.768kHz crystal to maintain an accurate real time clock. A 32kHz clock output is available on a dedicated module pin in both active power save modes. The 32kHz clock output may be used to drive the clock input of other system devices. This avoids the need for an additional crystal thereby minimizing total system cost.

The module has FCC & IC modular approval for use in the United States and Canada, CE approval for use in Europe, TELEC/MIC approval for use in Japan and related approvals for use in other countries.

## 2 Block Diagram

**Figure 1** is a block diagram of the AMWx06 module. The main components of the module are a microprocessor and BCM43362 Wi-Fi System-on-Chip (SoC). The processor and peripherals are driven by a 26MHz crystal. The integrated real-time clock (RTC) is driven by a 32.768kHz crystal. An on-board 1MByte serial flash chip may be used to store user data and configuration,

additional applications, and firmware images as part of the Zentri secure over the air (OTA) update process.

The WLAN subsystem is controlled by ZentriOS enabling the module to achieve minimum power consumption when the Wi-Fi networking interface is not required. The module includes an antenna diversity switch. The switch enables static or dynamic control of the external antenna(s).

**Figure 1. AMW006 / AMW106 Architecture**

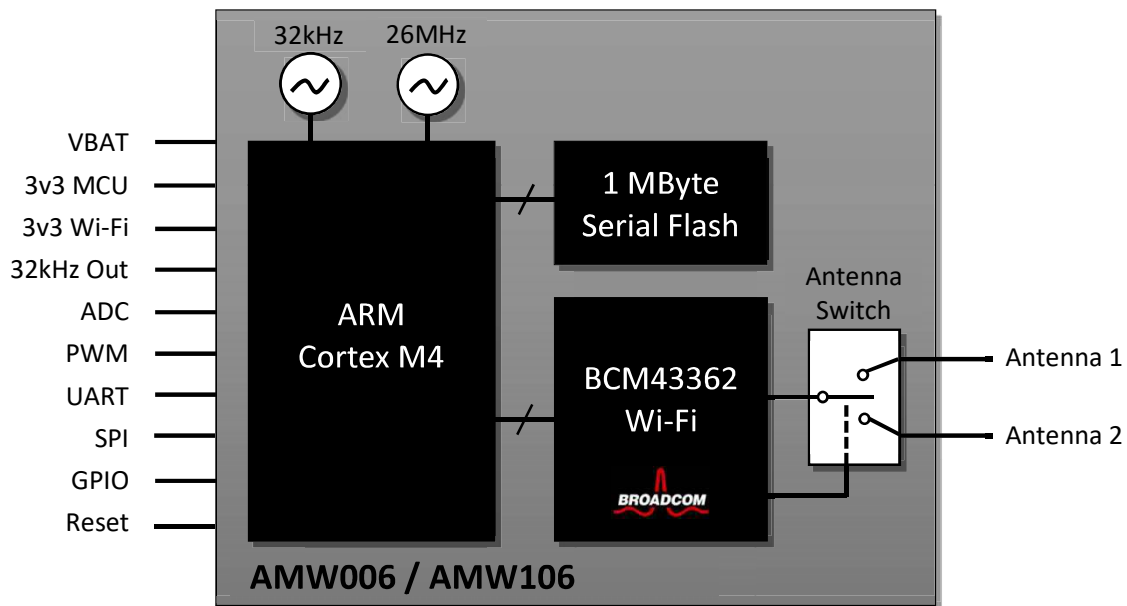



## 3 Electrical Specifications

### 3.1 Absolute Maximum Ratings

CAUTION! The absolute maximum ratings in Table 1 and Table 2 indicate levels where permanent damage to the device can occur, even if these limits are exceeded for only a brief duration. Functional operation is not guaranteed under these conditions. Operation at absolute maximum conditions for extended periods can adversely affect long-term reliability of the device.

The values in Table 1 reflect absolute maximum ratings from the respective microprocessor and BCM43362 datasheets.

**Table 1. Absolute Maximum Voltage Ratings**

Symbol	Ratings	Min	Max	Unit
V <sub>BAT</sub>	External power supply voltage to MCU VBAT pin	-0.3	4.0	V
VDD_3V3	External power supply voltage to MCU subsystem	-0.3	4.0	
VDD_WIFI	External power supply voltage to WLAN subsystem	-0.5	6.0	
V <sub>in</sub>	Input voltage on any other MCU pin	GND - 0.3	VDD_3V3 + 4.0	

**Table 2. Absolute Maximum Environmental Ratings**

Characteristic	Note	Min	Max	Unit
Storage Temperature	–	-40	+125	°C
Relative Humidity	Non-condensing (storage)	–	65	%

### 3.2 Recommended Operating Conditions

Functional operation is not guaranteed outside the limits shown in Table 3 and Table 4, and operation outside these limits for extended periods can adversely affect long-term reliability of the device.

#### 3.2.1 DC Operating Conditions

**Table 3. Recommended DC Operating Conditions**

Symbol	Ratings	Min	Typ	Max	Unit
V <sub>BAT</sub>	External power supply voltage to MCU VBAT pin	3.0	3.3	3.6	V
VDD_3V3 <sup>1</sup>	External power supply voltage to MCU subsystem	3.0	3.3	3.6	
VDD_WIFI <sup>1,2</sup>	External power supply voltage to WLAN subsystem	3.0	3.3	3.6	

**Notes:**

1. VDD\_3V3 and VDD\_WIFI must be at the same voltage when using the Wi-Fi subsystem
2. The performance of the Wi-Fi subsystem is degraded significantly at low voltages

### 3.2.2 Environmental Conditions

Table 4. Recommended Environmental Conditions

Characteristic	Note	Min	Max	Unit
Ambient Temperature	Limited by WLAN chip specification	-30	+85	°C
Relative Humidity	Non-condensing (operating)	–	85	%

### 3.3 Power Consumption

Table 5. Power consumption (VDD\_3V3, VDD\_WIFI, VBAT @ 3.3V)

Operational State	Note	Typ <sup>1</sup>	Max <sup>1</sup>	Max <sup>1</sup>	Unit
			T <sub>A</sub> = 25°C	T <sub>A</sub> = 85°C	
VBAT <sup>7</sup>	MCU VBAT Mode, RTC on, Wi-Fi powered off	0.97	–	3.0	µA
Standby <sup>7</sup>	MCU Standby Mode, RTC on, Wi-Fi powered off	3.8	5.0	17.0	µA
Stop <sup>3,7</sup>	MCU Stop Mode, Wi-Fi powered off	10	28	230	µA
Wi-Fi Powersave <sup>2,3</sup>	MCU Stop mode, Wi-Fi in powersave	0.77	–	–	mA
Active Receive <sup>2,3,4</sup>	MCU Stop mode, Wi-Fi active receive	5.7	–	–	mA
Active Transmit <sup>2,3,5</sup>	MCU Stop mode, Wi-Fi active transmit	11.4	–	–	mA
Wi-Fi Tx Test Mode <sup>6</sup>	MCU Stop mode, Wi-Fi active transmit	–	320	–	mA

**Notes:**

1. Total combined current consumed by all power supplies: VBAT, VDD\_3V3, VDD\_WIFI.
2. 802.11 beacon Interval = 102.4ms, DTIM=3, Beacon Duration = 1ms @ 1Mbps.
3. MCU Stop Mode with 113µs wakeup latency (flash in deep power down mode), VDD\_WIFI = 0V
4. Average current receiving 1Mbit/s UDP at 802.11n MCS7
5. Average current transmitting 1Mbit/s UDP at 802.11n MCS7
6. Wi-Fi Transmitting at +18dBm CCK 11Mbit/s with maximum duty cycle
7. Hardware capability; minimum power consumption is dependent on ZentriOS version and external components connected to AMWx06 pins

### 3.4 32kHz Crystal

Table 6. 32kHz Crystal Specifications<sup>1</sup>

Operational State	Note	Min	Typical	Max	Unit
Frequency		–	32768	–	Hz
Frequency Tolerance		–	20	–	ppm
Frequency Ageing	Measured @25 °C ±3 °C	-3	–	+3	ppm

**Notes:**

1. Reproduced from manufacturer's datasheet.

## 4 WLAN RF Specifications

The AMWx06 WLAN radio specifications are derived from the Cypress CYW43362 WLAN radio specifications.

Unless otherwise stated, the specifications in this section apply when the operating conditions are within the limits specified in Section 3.2, Recommended Operating Conditions. Functional operation outside these limits is not guaranteed.

All specifications are measured by connecting directly to either of the antenna ports via a short PCB trace with the other antenna port terminated in 50 ohms.

### 4.1 Summary WLAN Specifications

Table 7. Summary WLAN Specifications

Feature Supported	Description
WLAN Standard	IEEE 802.11b/g/n 1x1 SISO
Frequency Band	2.400 GHz – 2.484 GHz
WLAN Channels	Channels 1 – 13
Data Rates	802.11b (1, 2, 5.5, 11 Mbps) 802.11g (6, 9, 12, 24, 36, 48, 54 Mbps) 802.11n (HT20 MCS0-MCS7)
Maximum Receive level @ 2.4GHz	-2.5 dBm @ 1, 2 Mbps (8% PER, 1024 octets) -8.5 dBm @ 5.5, 11 Mbps (8% PER, 1024 Octets) -12 dBm @ 6-54 Mbps (10% PER, 1000 Octets)
Maximum RF Tx Output Power	+18 dBm @ 802.11b (EVM < -9 dB) +14 dBm @ 802.11n MCS7 (EVM < -28 dB)
Carrier Frequency Accuracy	±20 ppm (26MHz crystal with ±10 ppm @ 25C)

### 4.2 WLAN Receiver Specifications

Table 8. WLAN Receiver Performance Specifications

Parameter	Condition/Notes	Min	Typical	Max	Unit
Frequency Range	–	2400	–	2500	MHz
Operating Temperature <sup>1</sup>	–	-30	–	+85	°C
Receive Sensitivity <sup>2</sup> (8% PER for 1024 octet PSDU) at either antenna port <sup>3</sup>	1 Mbps DSSS	–	-94	-91	dBm
	11 Mbps CCK	–	-87	-83	
Receive Sensitivity <sup>2</sup> (10% PER for 1000 octet PSDU) at either antenna port <sup>3</sup>	6 Mbps OFDM	–	-86	-81	dBm
	54 Mbps OFDM	–	-73	-69	

Parameter	Condition/Notes	Min	Typical	Max	Unit
Receive Sensitivity <sup>2</sup> (10% PER for 4096 octet PSDU) at either antenna port <sup>3</sup> . Defined for default parameters: GF, 800ns GI, and non-STBC	65 Mbps MCS0, HT20	-	-86	-81	dBm
	65 Mbps MCS7, HT20	-	-70	-65	
Max. Receive Level @ 2.4GHz	@ 1, 2 Mbps (8% PER, 1024 octets)	-2	-	-	dBm
	@ 5.5, 11 Mbps (8% PER, 1024 Octets)	-8	-	-	
	@ 6-54 Mbps (10% PER, 1000 Octets)	-11.5	-	-	

**Notes:**

1. Operation below -20°C and above +65°C with parameter derating per Note 2
2. Derate receive sensitivity by 1.5dB for operation between temperatures of -30°C to -20°C and 65°C to 85°C
3. All measurements performed with the other antenna port terminated in 50 ohms

### 4.3 WLAN Transmitter Specifications

Table 9. WLAN Transmitter Performance Specifications

Parameter	Condition/Notes	Min	Typical	Max	Unit	
Frequency Range	-	2400	-	2500	MHz	
Operating Temperature <sup>1</sup>	-	-30	-	+85	°C	
Transmit power <sup>2</sup> measured at either antenna port <sup>3</sup> for highest power level setting at 25°C, VDD-3V3_RF_IN=3.3V with spectral mask and EVM compliance	<b>EVM does NOT exceed :</b>					
	1 Mbps DSSS	-11 dB	+14	+16	+18	dBm
	11 Mbps CCK	-11 dB	+14	+16	+18	
	6 Mbps OFDM	-22 dB	+12	+14	+16	
	54 Mbps OFDM	-25 dB	+12	+14	+16	
	MCS0, HT20	-22 dB	+10	+12	+14	
	MCS7, HT20	-28 dB	+10	+12	+14	

**Notes:**

1. Operation below -20°C and above +65°C with parameter derating per Note 2
2. Derate transmit power by 1.5dB for operation between temperatures of -30°C to -20°C and 65°C to 85°C
3. All measurements performed with the other antenna port terminated in 50 ohms

## 5 Pinout and Signal Descriptions

### 5.1 Pinout

A top view of the AMWx06 pinout is depicted in **Error! Reference source not found.** All dimensions are in thousands of an inch. A recommended footprint is provided in Section 6.1.

The module orientation can be determined from antenna pins 47 and 43, which show as notches in surrounding soldered ground pins.

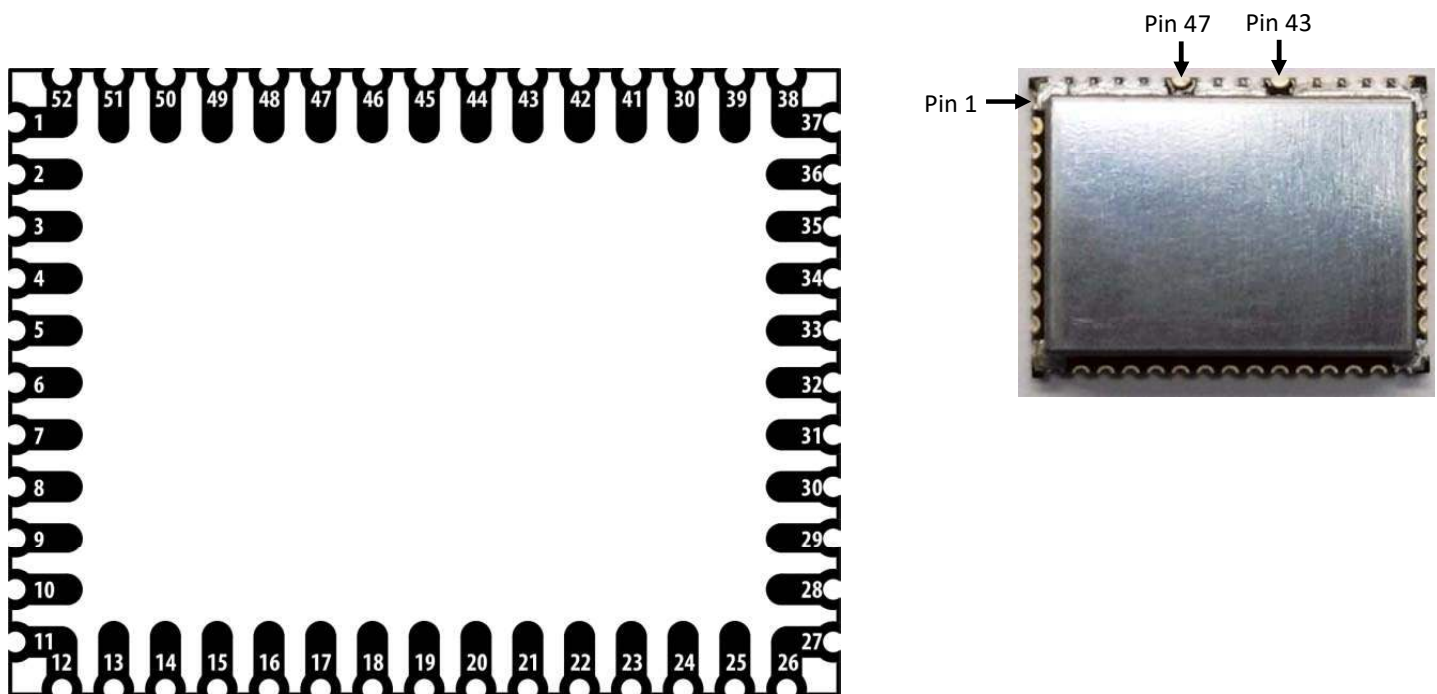

Figure 2 – AMWx06 pin out.

Determine module orientation from antenna pins 47 and 43, which show as notches in surrounding soldered ground pins

### 5.2 Pin Description

Table 10. AMWx06 ZentriOS Pin Definitions

Pin	Name	Type <sup>1</sup>	Primary Function	Alternate & Other Function(s)
1-2	GND	S	Ground	-
3	VBAT	S	VBAT MCU supply	-
4	GPIO_0	I/O	Factory Reset <sup>2</sup>	SPI1_MISO (S), GPIO
5	GPIO_1	I/O	GPIO	-
6	GPIO_2	I/O	GPIO	SPI1_SCK (S)
7	GPIO_3	I/O	GPIO	SPI1_CS (S)
8	GPIO_4	I/O	GPIO	-

Pin	Name	Type <sup>1</sup>	Primary Function	Alternate & Other Function(s)
9	OSC_32K_OUT	O	OSC_32K_OUT	-
10	VDD_3V3	I/O	3.3V MCU supply	
11-12	GND	S	Ground	-
13	GPIO_5	I/O	GPIO	SPI1_MOSI (slave), PWM5
14	GPIO_6	I/O	SPIO_MISO (M) <sup>5</sup>	ADC6 (when SPI not in use). Not available for digital I/O.
15	GPIO_7	I/O	SPIO_SCK (M) <sup>5</sup>	ADC5 (when SPI not in use). Not available for digital I/O.
16	GPIO_8	I/O	SPIO_MOSI (M) <sup>5</sup>	ADC7 (when SPI not in use). Not available for digital I/O.
17	GPIO_9	I/O	GPIO	UART0_RTS
18	GPIO_10	I/O	GPIO	UART0_CTS, PWM0
19	GPIO_11	I/O	UART0_RX	GPIO, PWM0
20	GPIO_12	I/O	UART0_TX	GPIO, PWM0
21	GPIO_13	I/O	GPIO	PWM1
22	GPIO_14	I/O	GPIO	PWM3
23	GPIO_15	I/O	GPIO	PWM3
24	GPIO_16	I/O	GPIO	PWM6
25	GPIO_17	I/O	GPIO	UART1_RX, ADC3, PWM4
26-27	GND	I/O	Ground	-
28	GPIO_18	I/O	GPIO	-
29	GPIO_19	I/O	GPIO	UART1_TX, ADC2, PWM4
30	GPIO_20	I/O	GPIO	ADC9, PWM2
31	GPIO_21	I/O	GPIO	ADC8, PWM2
32	GPIO_22	I/O	GPIO	UART1_CTS, WAKE, ADC0, PWM1
33	GPIO_23	I/O	GPIO	UART1_RTS, ADC1, PWM4
34	RESET_N	I	System Reset <sup>4</sup>	
35	VDD_WIFI	S	3.3V WLAN supply	-
36-42	GND	S	Ground	-
43	ANTENNA_1	O	Wi-Fi Antenna <sup>3</sup>	-
44-46	GND	S	Ground	-
47	ANTENNA_2	O	Wi-Fi Antenna <sup>3</sup>	-

Pin	Name	Type <sup>1</sup>	Primary Function	Alternate & Other Function(s)
48-52	GND	S	Ground	-

**Notes:**

1. *I = Input, O = Output, S = Supply*
2. *Factory reset is sampled at power-on-reset and available for other purposes thereafter.*
3. *Wi-Fi Antenna pins are AC-coupled and have a nominal 50 ohms output impedance.*
4. *The module Reset pin is connected to the internal MCU via a 1k resistor. We recommend driving the pin. If the pin is not driven, connect a 0.1uF capacitor to ground close to the pin to bypass noise which may cause unintended reset.*
5. *Connected to SPI serial flash inside the module.*

## 6 Design Guidelines

### 6.1 Recommended PCB Footprint

All dimensions in Figure 3 are in thousands of an inch unless otherwise marked.

Figure 3. AMWx06 Recommended Footprint (Top)

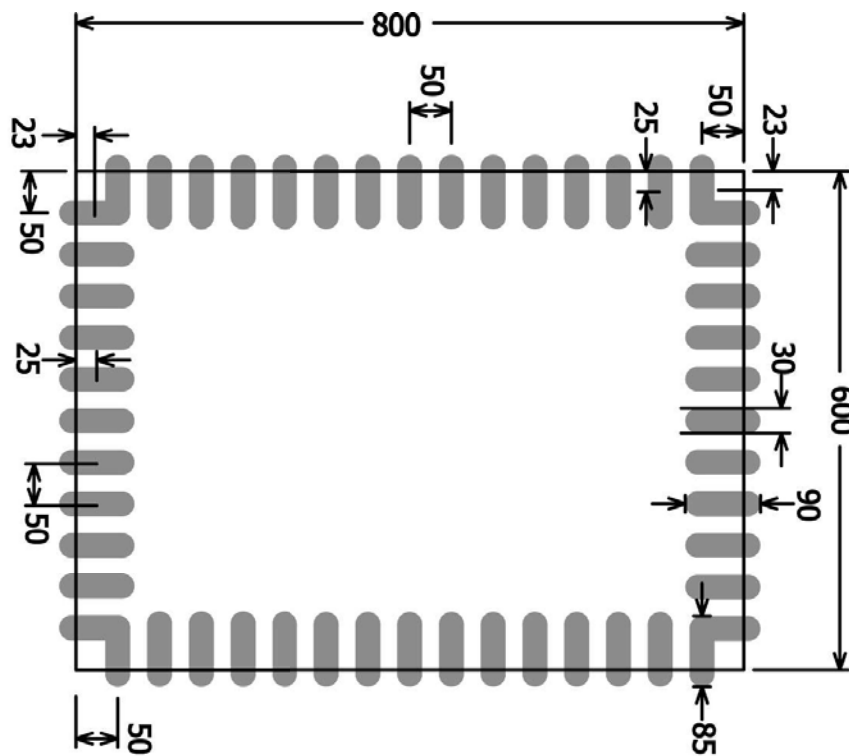

## 6.2 Routing Recommendations

When designing a carrier board, the addition of ground fill directly underneath the AMWx06 module, rather than signal or power traces, is recommended. If traces must be routed directly beneath the module, avoid routing directly underneath keepout areas shown in Figure 4 (ground fill is ok). All ground pads adjacent to antenna pins must be connected to a solid ground plane. Failure to comply with these recommendations may result in degraded performance of WLAN functionality.

Figure 4. AMWx06 Keepouts (TOP VIEW)

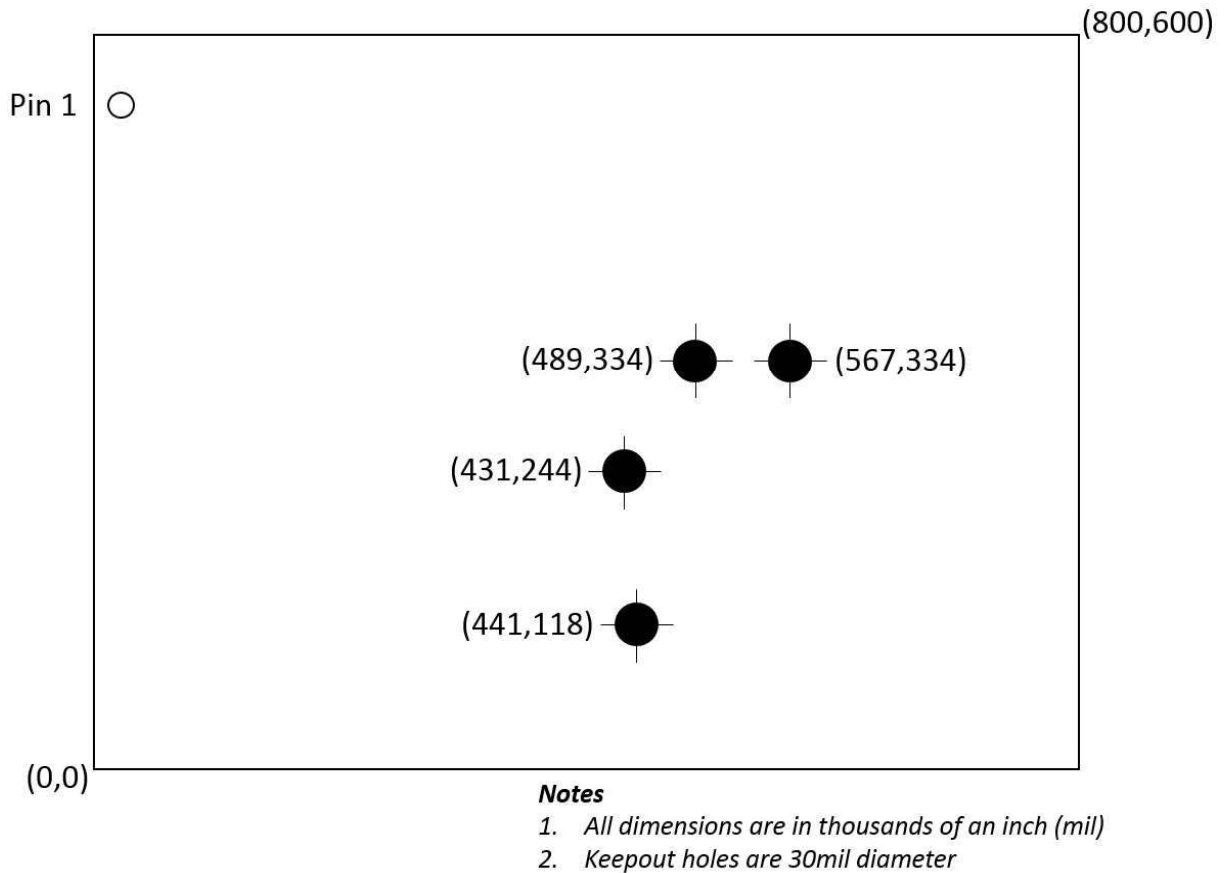



### 6.3 Soldering Information

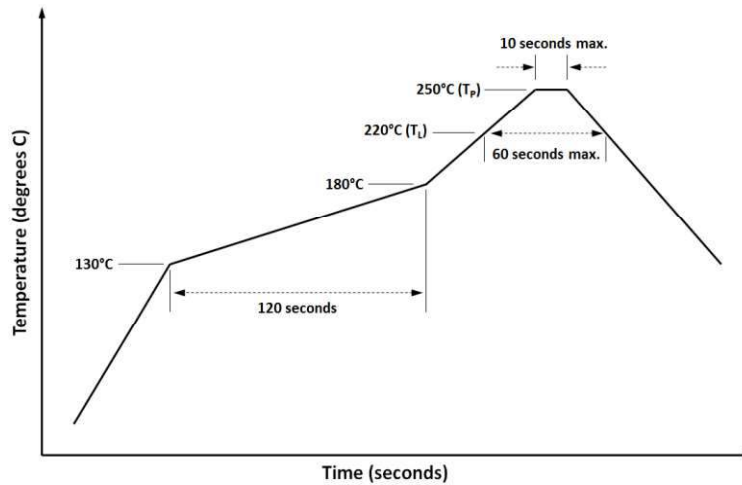

Figure 5 - Recommended solder reflow profile

Oven Name: HELLER

Process Window Name: ALPHA\_OM325

Setpoints (摄氏度)									
Zone	1	2	3	4	5	6	7	8	9
Top	100	120	140	160	180	200	235	255	250
Bottom	100	120	140	160	180	200	235	255	250

Conveyor Speed ( cm/min ): 70.0

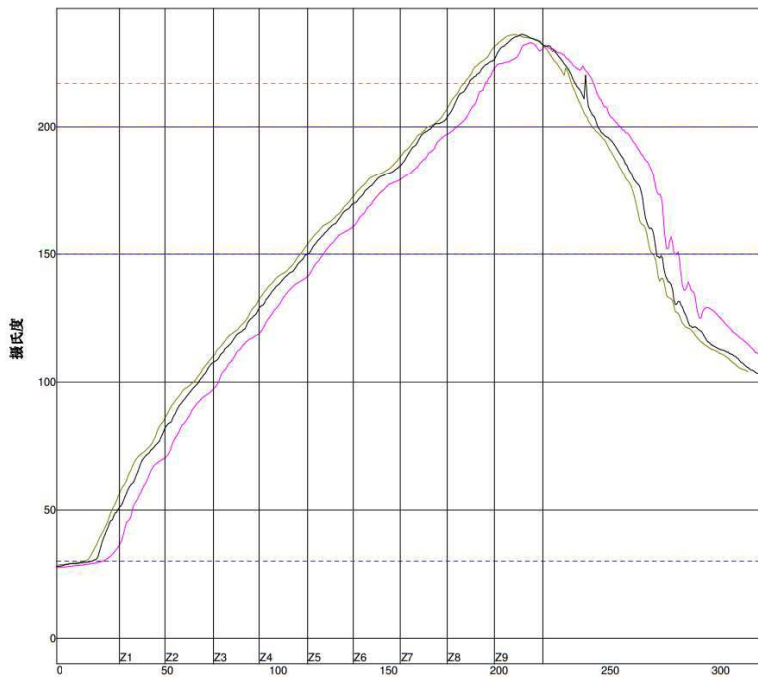

	PWI= 87%	Max Rising Slope	Max Falling Slope	Preheat	30-150C	Soak Time 150-200C	Reflow Time /217C	Peak Temp				
<TC2>	1.64	9%	-4.74	-87%	99.98	50%	60.17	-71%	48.88	-37%	232.83	-77%
<TC4>	1.62	8%	-3.27	-14%	98.09	45%	57.87	-78%	48.45	-39%	235.95	-52%
<TC5>	1.65	10%	-3.43	-22%	98.04	45%	56.43	-82%	48.08	-40%	236.06	-52%
Delta	0.03		1.47		1.94		3.74		0.80		3.23	

Figure 6 - Example solder reflow profile (AMW006-E03 evaluation board)

**Note:** Zentri recommends a “No-Clean” soldering process to avoid getting contaminants under the shield cans.

## 6.4 Module Photograph

Figure 7. AMW006 Photograph (Top)



## 6.5 External Antennas

The AMWx06 module supports two external antennas and per-packet antenna diversity to achieve maximum range. Antenna selection is available by setting ZentriOS variables.

**NOTE!** BOTH antenna ports must be terminated in 50 ohms. If a single antenna is used, the other antenna port should be terminated with a 50 ohm load. Failure to terminate both antenna ports may result in degraded radio performance.

Table 11 - Tested External Antenna Types

Model	Type <sup>1</sup>	Gain (dBi)
Printed antenna	PCB trace	3.2
Wire	Monopole	2.1
Johanson Tech. 2450AT42A100E	Chip	0.0
ACA-1SRPP-2400	Monopole	0.6
ACA-4HSRPP-2458	Monopole	1.0

(1) An antenna type comprises antennas having similar in-band and out-of-band radiation patterns.

### 6.5.1 PCB Trace Antenna

This 2.4 GHz PCB antenna can fit in an area smaller than 21mm x 10mm, and as small as 15mm x 6mm. To achieve optimum performance, make an exact copy of this reference design.

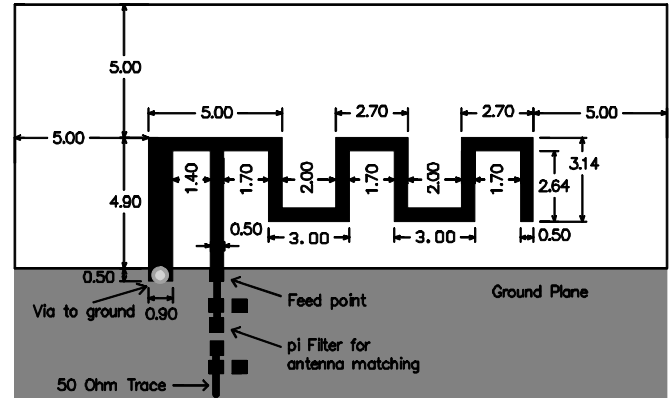
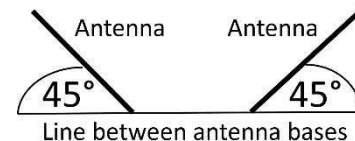

Figure 8 - Trace Antenna (dimensions in mm)

### 6.5.2 Wire Antenna

A suitable wire antenna is an 18-gauge wire with a length of 25.4mm ± 2mm. The wire antennas should be perpendicular to each other, and at 45 degrees to the line between the antenna bases.



**NOTE!** Do **NOT** bend antennas backwards over the module; doing so will cause poor performance and may cause undesirable out-of-band radio transmissions.



Figure 9 - AMW006-E03 eval board with wire antennas

#### 1.1.1 Chip Antenna

The AMWx06 is certified for use with a chip antenna from Johanson, part number 2450AT42A100E. Be sure

to follow the antenna layout design guidelines in the antenna datasheet.

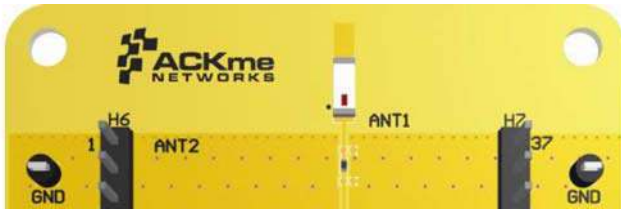

Figure 10 – Chip antenna layout example

### 6.5.3 Monopole Antenna

A u.FL connector layout such as the one shown below can be used to connect the whip antenna(s).

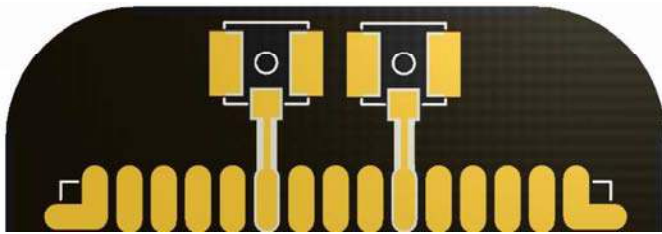

Figure 11 - u.FL connector layout

Suitable monopole antennas include the [ACA\\_1SSRPP\\_2400](http://ack.me) and [ACA\\_4HSRPP\\_2458](http://ack.me), both of which are available online at <http://ack.me>.



Figure 12 - ACA-1SSRPP-2400



Figure 13 - ACA-4HSRPP-2458

## 6.6 Application Examples

### 6.6.1 Operation using ZentriOS

To use ZentriOS, the module only requires an external connection to power and a UART serial interface. A host processor connects to UART0 (pins 19/20) or UART1 (pins 25/29) as shown in Figure 14.

Figure 14. Using the AMW006 Module with ZentriOS and a UART serial interface

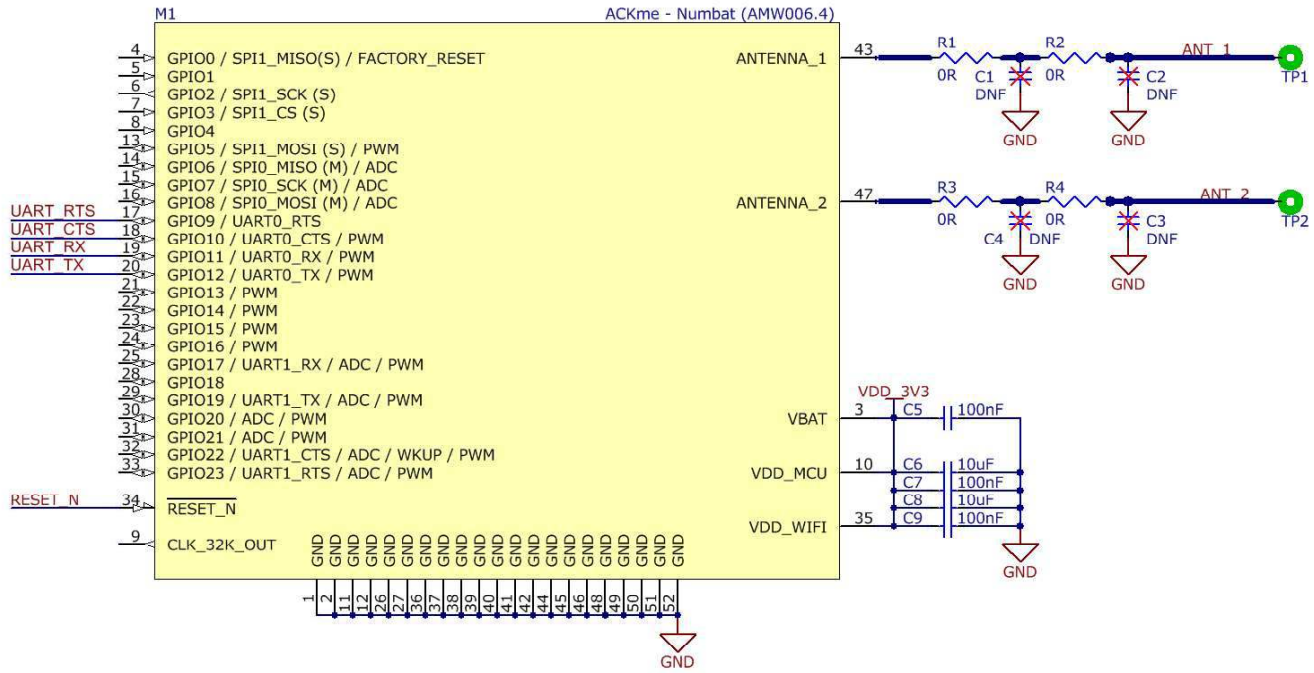

## 7 Regulatory Certification

The AMW006 module has been certified for operation in various regulatory domains. This section outlines certification information specific to the following countries and regions:

- United States
- Canada
- Europe
- Australia
- New Zealand
- Japan

Should you require regulatory certification for the AMW006 module in a country or region not listed, please contact your local Zentri sales office or create a support request via our website at <http://ack.me/contact>.

### 7.1 United States

The Zentri AMW006 module has received Federal Communications Commission (FCC) CFR47 Telecommunications, Part 15 Sub-part C “Intentional Radiators” modular approval in accordance with Part 15.212 Modular Transmitter approval. Modular approval allows the end user to integrate the AMW006 module into a finished product without obtaining subsequent and separate FCC approvals for intentional radiation, provided no changes or modifications are made to the module circuitry. Changes or modifications could void the user’s authority to operate the equipment. The end user must comply with all of the instructions provided by the Grantee which indicate installation and/or operating conditions necessary for compliance.

The finished product is required to comply with all applicable FCC equipment authorization, regulations, requirements, and equipment functions not associated with the transmitter module portion. For example, compliance must be demonstrated to regulations for other transmitter components within the host product; to requirements for unintentional radiators (Part 15 Sub-part B “Unintentional Radiators”), such as digital devices, computer peripherals, radio receivers, etc.; and to additional authorization requirements for non-transmitter functions on the transmitter module (i.e. Verification, or Declaration of Conformity) (e.g.,

transmitter modules may also contain digital logic functions) as appropriate.

#### 7.1.1 Labeling and User Information Requirements

The AMW006 module has been labelled with a unique FCC ID number, and if the FCC ID is not visible when the module is installed inside another device, then the outside of the finished product into which the module is installed must also display a label referring to the enclosed module. This exterior label can use wording as follows:

Contains FCC ID: 2ABPY-B5BD9  
 This device complies with Part 15 of the FCC Rules.  
 Operation is subject to the following two conditions:  
 (1) this device may not cause harmful interference,  
 and (2) this device must accept any interference  
 received, including interference that may cause  
 undesired operation.

The user manual for the product should include the following statement:

This equipment has been tested and found to comply with the limits for a Class B digital device, pursuant to part 15 of the FCC Rules. These limits are designed to provide reasonable protection against harmful interference in a residential installation. This equipment generates, uses and can radiate radio frequency energy and if not installed and used in accordance with the instructions, may cause harmful interference to radio communications. However, there is no guarantee that interference will not occur in a particular installation. If this equipment does cause harmful interference to radio or television reception, which can be determined by turning the equipment off and on, the user is encouraged to try to correct the interference by one or more of the following measures:

- Reorient or relocate the receiving antenna.
- Increase the separation between the equipment and receiver.
- Connect the equipment into an outlet on a circuit different from that to which the receiver is connected.
- Consult the dealer or an experienced radio/TV technician for help.

Additional information on labeling and user information requirements for Part 15 devices can be found in KDB Publication 784748 available at the FCC Office of Engineering and Technology (OET) Laboratory Division Knowledge Database (KDB) at the following website:

<https://apps.fcc.gov/oetcf/kdb/index.cfm>

### 7.1.2 RF Exposure

All transmitters regulated by FCC must comply with RF exposure requirements. OET Bulletin 65, Evaluating Compliance with FCC Guidelines for Human Exposure to Radio Frequency Electromagnetic Fields, provides assistance in determining whether proposed or existing transmitting facilities, operations or devices comply with limits for human exposure to Radio Frequency (RF) fields adopted by the Federal Communications Commission (FCC). The bulletin offers guidelines and suggestions for evaluating compliance.

If appropriate, compliance with exposure guidelines for mobile and unlicensed devices can be accomplished by

the use of warning labels and by providing users with information concerning minimum separation distances from transmitting structures and proper installation of antennas.

The following statement must be included as a CAUTION statement in manuals and OEM products to alert users of FCC RF exposure compliance:

To satisfy FCC RF Exposure requirements for mobile and base station transmission devices, a separation distance of 20 cm or more should be maintained between the antenna of this device and persons during operation. To ensure compliance, operation at closer than this distance is not recommended. The antenna(s) used for this transmitter must not be co-located or operating in conjunction with any other antenna or transmitter

If the AMW006 module is used in a portable application (i.e., the antenna is less than 20 cm from persons during operation), the integrator is responsible for performing Specific Absorption Rate (SAR) testing in accordance with FCC rules 2.1091.

### 7.1.3 Approved External Antenna Types

Modular approval testing of the AMW006 was performed with the antenna types listed in Table 11 - Tested External Antenna Types.

To maintain modular approval in the United States, only the tested antenna types shall be used. It is permissible to use different antenna manufacturers provided the antenna types match: in-band and out-of-band radiation patterns and antenna gain must be similar to those tested.

### 7.1.4 Further Information

Additional information regarding FCC certification and use of the AMW006 module in the United States is available from the following sources.

- Federal Communications Commission (FCC)  
<http://www.fcc.gov.au>
- FCC Office of Engineering and Technology (OET) Laboratory Division Knowledge Database (KDB)  
<http://apps.fcc.gov/oetcf/kdb/index.cfm>



## 7.2 Canada

The AMW006 module has been certified for use in Canada under Industry Canada (IC) Radio Standards Specification (RSS) RSS-210 and RSSGen. Modular approval permits the installation of a module in a host device without the need to recertify the device.

### 7.2.1 Labeling and User Information Requirements

Labeling Requirements for the Host Device (from Section 3.2.1, RSS-Gen, Issue 3, December 2010): The host device shall be properly labeled to identify the module within the host device.

The Industry Canada certification label of a module shall be clearly visible at all times when installed in the host device, otherwise the host device must be labeled to display the Industry Canada certification number of the module, preceded by the words “Contains transmitter module”, or the word “Contains”, or similar wording expressing the same meaning, as follows:

Contains transmitter module IC: 11685A-61F8D

User Manual Notice for License-Exempt Radio Apparatus (from Section 7.1.3 RSS-Gen, Issue 3, December 2010): User manuals for license-exempt radio apparatus shall contain the following or equivalent notice in a conspicuous location in the user manual or alternatively on the device or both:

This device complies with Industry Canada license-exempt RSS standard(s). Operation is subject to the following two conditions: (1) this device may not cause interference, and (2) this device must accept any interference, including interference that may cause undesired operation of the device.

Le présent appareil est conforme aux CNR d'Industrie Canada applicables aux appareils radio exempts de licence. L'exploitation est autorisée aux deux conditions suivantes: (1) l'appareil ne doit pas produire de brouillage, et (2) l'utilisateur de l'appareil doit accepter tout brouillage radioélectrique subi, même si le brouillage est susceptible d'en compromettre le fonctionnement.

Transmitter Antenna Notification (from Section 7.1.2 RSS-Gen, Issue 3, December 2010): User manuals for transmitters shall display the following notice in a conspicuous location:

Under Industry Canada regulations, this radio transmitter may only operate using an antenna of a type and maximum (or lesser) gain approved for the transmitter by Industry Canada. To reduce potential radio interference to other users, the antenna type and its gain should be so chosen that the equivalent isotropically radiated power (EIRP) is not more than that necessary for successful communication.

Conformément à la réglementation d'Industrie Canada, le présent émetteur radio peut fonctionner avec une antenne d'un type et d'un gain maximal (ou inférieur) approuvé pour l'émetteur par Industrie Canada. Dans le but de réduire les risques de brouillage radioélectrique à l'intention des autres utilisateurs, il faut choisir le type d'antenne et son gain de sorte que la puissance isotrope rayonnée équivalente (p.i.r.e.) ne dépasse pas l'intensité nécessaire à l'établissement d'une communication satisfaisante.

The above notice may be affixed to the device instead of displayed in the user manual.

User manuals for transmitters equipped with detachable antennas shall also contain the following notice in a conspicuous location:

This radio transmitter (identify the device by certification number, or model number if Category II) has been approved by Industry Canada to operate with the antenna types listed below with the maximum permissible gain and required antenna impedance for each antenna type indicated. Antenna types not included in this list, having a gain greater than the maximum gain indicated for that type, are strictly prohibited for use with this device.

Le présent émetteur radio (identifier le dispositif par son numéro de certification ou son numéro de modèle s'il fait partie du matériel de catégorie I) a été approuvé par Industrie Canada pour fonctionner avec les types d'antenne énumérés ci-dessous et ayant un gain admissible maximal et l'impédance requise pour chaque type d'antenne. Les types d'antenne non inclus dans cette liste, ou dont le gain est supérieur au gain maximal indiqué, sont strictement interdits pour l'exploitation de l'émetteur.

Immediately following the above notice, the manufacturer shall provide a list of all antenna types approved for use with the transmitter, indicating the maximum permissible antenna gain (in dBi) and required impedance for each.

### 7.2.2 External Antenna Types

Modular approval testing of the AMW006 was performed with the antenna types listed in Table 11 - Tested External Antenna Types.

Transmitter Antenna (from Section 7.1.2 RSS-Gen, Issue 3, December 2010):

The AMW006 module can only be sold or operated with antennas with which it was approved. Transmitter may be approved with multiple antenna types. An antenna type comprises antennas having similar in-band and out-of-band radiation patterns. Testing shall be performed using the highest gain antenna of each combination of transmitter and antenna type for which approval is being sought, with the transmitter output

power set at the maximum level. Any antenna of the same type having equal or lesser gain as an antenna that had been successfully tested with the transmitter, will also be considered approved with the transmitter, and may be used and marketed with the transmitter.

When a measurement at the antenna connector is used to determine RF output power, the effective gain of the device's antenna shall be stated, based on measurement or on data from the antenna manufacturer.

For transmitters of output power greater than 10 milliwatts, the total antenna gain shall be added to the measured RF output power to demonstrate compliance to the specified radiated power limits.

### 7.2.3 Further Information

Additional information may be obtained from the Industry Canada website at <http://www.ic.gc.ca>

## 7.3 Europe

The AMW006 module is an R&TTE Directive assessed radio module that is CE marked and has been manufactured and tested with the intention of being integrated into a final product.

The AMW006 module has been tested to R&TTE Directives as summarized in Table 12. European Compliance Testing. Opinion has also been issued. All AMW006 test reports are available on the Zentri website at <https://www.zentri.com/contact-us>.

The R&TTE Compliance Association provides guidance on modular devices in the document titled Technical Guidance Note 01 available on the website at [http://www.rtteca.com/html/download\\_area.htm](http://www.rtteca.com/html/download_area.htm).



**NOTE:** To maintain conformance to the testing listed in Table 12. European Compliance Testing, the module shall be installed in accordance with the installation instructions in this data sheet and shall not be modified.

When integrating a radio module into a completed product the integrator becomes the manufacturer of the final product and is therefore responsible for demonstrating compliance of the final product with the essential requirements of the R&TTE Directive.

### 7.3.1 Labeling and User Information Requirements

The label on the final product which contains the AMW006 module must follow CE marking requirements. The R&TTE Compliance Association Technical Guidance Note 01 provides guidance on final product CE marking

#### 7.3.1 External Antenna Requirements

From R&TTE Compliance Association document Technical Guidance Note 01:

Provided the integrator installing an assessed radio module with an integral or specific antenna and installed in conformance with the radio module manufacturer's installation instructions requires no further evaluation under Article 3.2 of the R&TTE Directive and does not require further involvement of an R&TTE Directive Notified Body for the final product. [Section 2.2.4]

The European Compliance Testing listed in Table 12. European Compliance Testing was performed using antenna types listed in Table 11 - Tested External Antenna Types.

### 7.3.2 Further Information

A document that can be used as a starting point in understanding the use of Short Range Devices (SRD) in Europe is the European Radio Communications Committee (ERC) Recommendation 70-03 E, which can be downloaded from the European Radio Communications Office (ERO) at: <http://www.ero.dk>.

Further information may be obtained from the following websites:

- Radio and Telecommunications Terminal Equipment (R&TTE)  
[http://ec.europa.eu/enterprise/rtte/index\\_en.htm](http://ec.europa.eu/enterprise/rtte/index_en.htm)
- European Conference of Postal and Telecommunications Administrations (CEPT)  
<http://www.cept.org>
- European Telecommunications Standards Institute (ETSI)  
<http://www.etsi.org>
- European Radio Communications Office (ERO)  
<http://www.ero.dk>

The Radio and Telecommunications Terminal Equipment Compliance Association (R&TTE CA)  
<http://www.rtteca.com/>

**Table 12. European Compliance Testing**

Certification	Standard	Report Number	Date	Laboratory
Safety	EN 60950-1:2006, A11:2009, A1:2010, A12:2011, A2:2013	W6M21410-14584-L	Jan 15, 2015	Worldwide Testing Services (Taiwan) Co., Ltd.
EMF	EN 62311:2008	EA560122	Jul 1, 2015	Sporton International, Inc. (Taiwan)
EMC	EN 301 489-1 v1.9.2 (2011-09), Class B EN 301 489-17 v2.2.1 (2012-09) EN 55022:2010/AC:2011, Class B EN 55024:2010	EH560122	Jul 1, 2015	
Radio	EN 300 328 v1.9.1 (2015-02)	ER560122	Jul 1, 2015	
Notified Body Opinion	<b>CE1177</b>	TCF-1334TC15	Jul 5, 2015	TIMCO Engineering, Inc.

## 7.4 Australia

Australian radio regulations do not provide a modular approval policy similar to the United States (FCC) and Canada (IC). However, AMW006 module test reports may be used in part to demonstrate compliance in accordance with ACMA Radio communications “Short Range Devices” Standard 2004 which references Australia/New Zealand industry standard AS/NZS-4268:2012. AMW006 RF transmitter test reports may be used as part of the product certification and compliance folder. For further information regarding the availability of RF test reports, please contact Zentri at <https://www.zentri.com/contact-us>.

### 7.4.1 External Antenna Requirements

Compliance tests were performed using antenna types listed in Table 11 - Tested External Antenna Types.

If an external antenna is used with the AMW006 module, additional testing of the end product is needed to meet Australian regulatory requirements.

### 7.4.2 Further Information

Additional information may be obtained from the Australian Communications and Media Authority website at <http://www.acma.gov.au>.

## 7.5 New Zealand

New Zealand radio regulations do not provide a modular approval policy similar to the United States (FCC) and Canada (IC). However, AMW006 module test reports may be used in part to demonstrate compliance with the New Zealand “General User Radio License for Short Range Devices”. New Zealand Radio communications (Radio Standards) Notice 2010 references Australia/New Zealand industry standard AS/NZS-4268:2012. AMW006 RF transmitter test reports may be used as part of the product certification and compliance folder. For further information regarding the availability of RF test reports, please contact Zentri at <https://www.zentri.com/contact-us>.

### 7.5.1 External Antenna Requirements

Compliance tests were performed using antenna types listed in Table 11 - Tested External Antenna Types.

If an external antenna is used with the AMW006 module, additional testing of the end product is needed to meet New Zealand regulatory requirements.

## 7.5.2 Further Information

Additional information may be obtained from the New Zealand Radio Spectrum Ministry of Economic Development website at <http://www.rsm.govt.nz>.



## 7.6 Japan

The AMW006 has been tested to comply with the radio regulations set forth by the Japanese Ministry of

Internal Affairs and Communications (MIC) as documented in

Table 13. The module is certified for operation with each of the antenna types listed in Table 11 - Tested External Antenna Types.

**Table 13. Japan Compliance Testing**

Certification	Standard	Report Number	Date	Laboratory
Verification of Compliance	VCCI V-3/2014.04 Class B ITE	JV560122	Jul 1, 2015	Sporton International, Inc. (Taiwan)
Radio	Notice No. 88 Appendix No. 43	JRF560122	Jul 1, 2015	
Equipment Marking	  201-150256	152150256/AA/00	Jul 6, 2015	Telefication, BV. (The Netherlands)

## 8 Packaging, Handling and Storage, RoHS

### 8.1 Packaging

AMWx06 modules should be hand-soldered ONLY!

If reflow is required, AMWx06 modules must be baked first according to Joint Industry Standard J-STD-033C.

Modules are shipped in cut tape in lengths of 100 modules, with ESD-safe packaging, or in reels of 900 units.

Reels are shipped inside a moisture resistant sealed bag. The shelf life of the sealed reel is 12 months at 40°C and <90% Relative Humidity (RH). Please refer to the bag seal date and the following section for handling and storage.

### 8.2 Handling & Storage



#### **CAUTION** **MSL3 Sensitive Device!**

The AMW006 module is a moisture sensitive device rated at Moisture Sensitive Level 3 (MSL3) per **IPC/JEDEC J-STD-20**.

After opening the moisture sealed storage bag, modules that will be subjected to reflow solder or other high temperature processes must be:

1. mounted to a circuit board within 168 hours at factory conditions ( $\leq 30^{\circ}\text{C}$  and  $< 60\%$  RH)

**OR**

2. continuously stored per **IPC/JEDEC J-STD-033**

Modules that have been exposed to moisture and environmental conditions exceeding packaging and storage conditions **MUST** be baked before mounting according to **IPC/JEDEC J-STD-033**.

Failure to meet packaging and storage conditions will result in irreparable damage to modules during solder reflow.

### 8.3 RoHS Directive

The AMWx06 module is produced according to the RoHS (Restriction of the use of certain Hazardous Substances in electrical and electronic equipment) directive and complies with the directive.

## 8.4 Tape and Reel Specifications

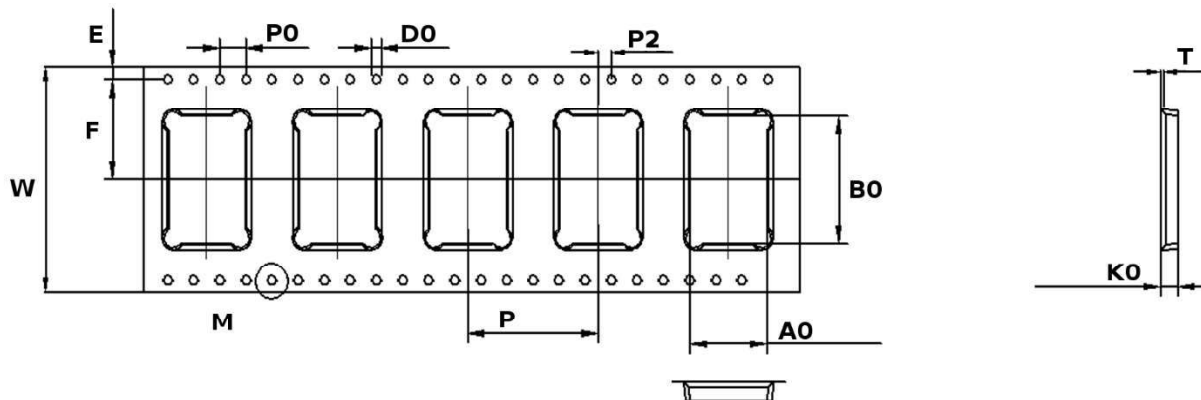

Figure 15 - Tape Specifications

Symbol	A0	B0	D0	E	F	K0
Specification (mm)	15.6 ± 0.10	20.8 ± 0.10	1.5 ± 0.10	1.75 ± 0.10	20.2 ± 0.10	3.10 ± 0.10

Symbol	P	P0	P2	T	W
Specification (mm)	20.0 ± 0.10	4.00 ± 0.10	2.00 ± 0.10	0.30 ± 0.05	44.0 ± 0.30

- Tape material : black PS material, in line with ROHS environmental management substances
- Tape thickness: 0.3 mm ± 0.05 mm
- Tape width: 44mm (1.76")
- Protection zone: black PS material
- Distance between chain hole centers within the range of ± 0.2 mm of cumulative error
- Anti-camber at 1 mm / 250 mm
- All dimensions in line with the requirements of EIA-481-D

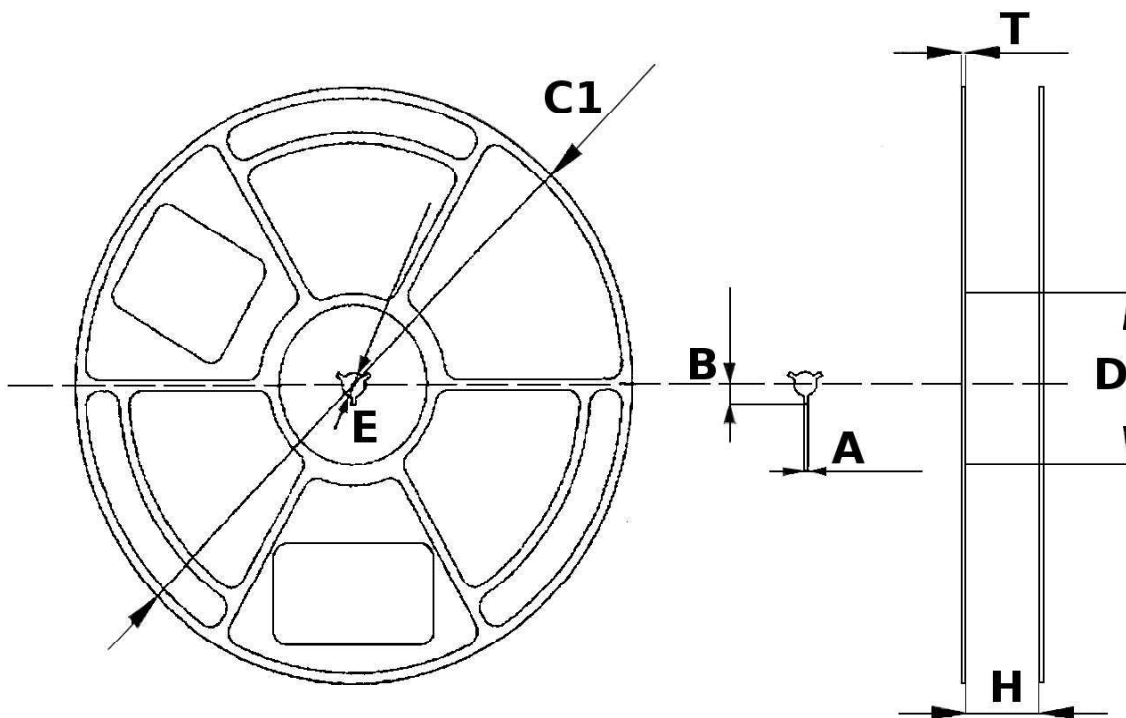

Figure 16 - Reel Specifications

Symbol	A	B	C1	D	E	H	T
Specification (mm)	$2.5 \pm 0.2$	$11 \pm 0.2$	$330 \pm 1$	$99.5 \pm 0.1$	$13.2 \pm 0.2$	$44.8 + 0.3 / -0.2$	$2.25 \pm 0.2$

## 8.5 Cut Tape and Reel Quantity

Cut tape is available in lengths of 100 units.

Smaller quantities may be available from some distributors. If smaller quantities are purchased, ensure that modules are managed in accordance with Moisture Sensitive Level 3 (MSL3) per **IPC/JEDEC J-STD-20**.

Each reel contains 900 units.

## 9 Ordering Information

You can order AMWx06 as either cut tape loaded with an unspecified ZentriOS, or as a full reel loaded with either a specific ZentriOS version or a version of your embedded custom application.

When you order, refer to the OPN (Orderable Part Number), as described below. For examples, see Table 14. Ordering Information.

### 9.1 Ordering an Unspecified ZentriOS Version

#### Order OPN: AMWx06

You can order an unspecified ZentriOS version as cut tape. The OPN is of the form <platform>, where <platform> is AMW006 or AMW106.

When ZentriOS version is unspecified, orders of AMW006 or AMW106 modules ship with whatever versions of ZentriOS are available. The firmware is not guaranteed to be the same for all items shipped. Cut tape is suitable for sampling, evaluation, and pilot builds.

Upon delivery, you can update modules individually, via OTA (Over-The-Air update), with a specific firmware version.

### 9.2 Ordering a Specific ZentriOS Version or a Custom Firmware Version

#### ZentriOS version order OPN: AMWx06-x.y.zR

#### Custom firmware version OPN: AMWx06-xxxxxxR

Volume orders are delivered in reels, as indicated by the R suffix. To ensure consistency, an OPN is specified, corresponding to a specific version.

ZentriOS version: the OPN is of the form <platform>-x.y.zR, where <platform> is AMW006 or AMW106, and x is major version, y is minor version and z is patch version.

Custom firmware version: the OPN is of the form <platform>-xxxxxx, where <platform> is AMW006 or AMW106, and xxxxxx is a unique ID indicating a specific product version. Zentri ships reels with the product version specified.

Custom firmware can be a product bundle for the AMW006 or AMW106. A custom product bundle includes a specific version of ZentriOS. An AMW106 ZAP product bundle also contains a ZAP (ZentriOS application).

**Table 14. Ordering Information**

Order Type	Delivery Format	Example OPN
Unspecified firmware	Cut tape	AMW006 AMW106
Specified ZentriOS version	Full reel box	AMW006-3.3.0R AMW106-3.2.2R
Custom firmware	Full reel box	AMW006-H35GHJR AMW106-FG7L21R

## 10 Revision History & Glossary

### 10.1 Revision History

Table 15: Document Revision History

Revision	Date	Change Description
ADS-MW006-100R	Oct 20, 2014	Initial preliminary release
ADS-MW006-101R	Nov 25, 2014	Updated schematic, PCB trace antenna
ADS-MW006-102R	Mar 20, 2015	Added note on reset pin
ADS-MW006-103R	Apr 10, 2015	Added note on MLS3 non-compliance, and note on power consumption
ADS-MW006-104R	May 5, 2015	Added solder reflow charts, AMW106 properties
ADS-MW006-105R	Jun 9, 2015	Removed AMW106 properties; updated GPIO and ADC details
ADS-MWx06-106R	Sep 1, 2015	Added AMW106 Updated/added ETSI/CE v1.9.1 and Japan certification Added tape and reel specifications.
ADS-MWx06-107R	June 6, 2016	Converted to Zentri branding.
ADS-MWx06-108R	Dec 21, 2016	Corrected tape specifications. Added firmware note in Ordering Information. Adding “No Clean” process note in Soldering Information.
ADS-MWx06-109R	May 1, 2017	Added label orientation diagram. Added firmware features page. Revised Ordering Information

### 10.2 Glossary

In most cases, acronyms and abbreviations are defined on first use. A comprehensive list of acronyms and other terms used in Zentri documents are provided at <https://docs.zentri.com/zentri/glossary>.



## 11 References

Throughout this data sheet, references to other documents are listed. The following documents provide additional material:

1. [IEEE 802.11 Standard – 2012](#)  
Institute of Electrical and Electronics Engineers.  
<http://standards.ieee.org>

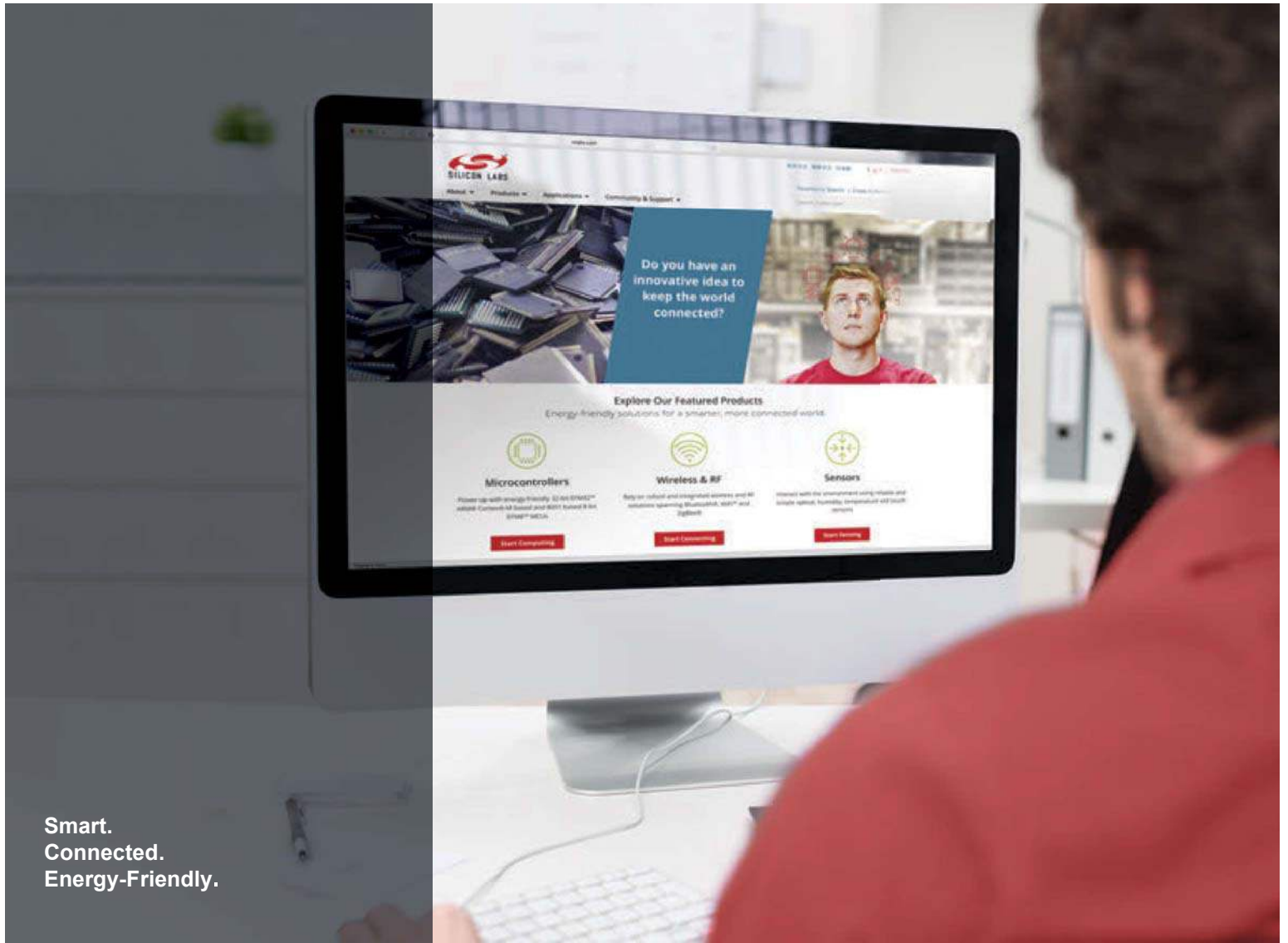

Smart.  
Connected.  
Energy-Friendly.



**Products**  
[www.silabs.com/products](http://www.silabs.com/products)

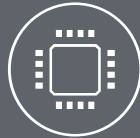

**Quality**  
[www.silabs.com/quality](http://www.silabs.com/quality)



**Support and Community**  
[community.silabs.com](http://community.silabs.com)

**Disclaimer**  
Silicon Labs intends to provide customers with the latest, accurate, and in-depth documentation of all peripherals and modules available for system and software implementers using or intending to use the Silicon Labs products. Characterization data, available modules and peripherals, memory sizes and memory addresses refer to each specific device, and "Typical" parameters provided can and do vary in different applications. Application examples described herein are for illustrative purposes only. Silicon Labs reserves the right to make changes without further notice and limitation to product information, specifications, and descriptions herein, and does not give warranties as to the accuracy or completeness of the included information. Silicon Labs shall have no liability for the consequences of use of the information supplied herein. This document does not imply or express copyright licenses granted hereunder to design or fabricate any integrated circuits. The products are not designed or authorized to be used within any Life Support System without the specific written consent of Silicon Labs. A "Life Support System" is any product or system intended to support or sustain life and/or health, which, if it fails, can be reasonably expected to result in significant personal injury or death. Silicon Labs products are not designed or authorized for military applications. Silicon Labs products shall under no circumstances be used in weapons of mass destruction including (but not limited to) nuclear, biological or chemical weapons, or missiles capable of delivering such weapons.

**Trademark Information**

Silicon Laboratories Inc.®, Silicon Laboratories®, Silicon Labs®, SiLabs® and the Silicon Labs logo®, Bluegiga®, Bluegiga Logo®, Clockbuilder®, CMEMS®, DSPLL®, EFM®, EFM32®, EFR, Ember®, Energy Micro, Energy Micro logo and combinations thereof, "the world's most energy friendly microcontrollers", Ember®, EZLink®, EZRadio®, EZRadioPRO®, Gecko®, ISOModem®, Precision32®, ProSLIC®, Simplicity Studio®, SiPHY®, Telegesis, the Telegesis Logo®, USBXpress® and others are trademarks or registered trademarks of Silicon Labs. ARM, CORTEX, Cortex-M3 and THUMB are trademarks or registered trademarks of ARM Holdings. Keil is a registered trademark of ARM Limited. All other products or brand names mentioned herein are trademarks of their respective holders.



Silicon Laboratories Inc.  
400 West Cesar Chavez  
Austin, TX 78701  
USA

<http://www.silabs.com>