

VOLTAGE SENSE TRANSFORMER

PA3000NL

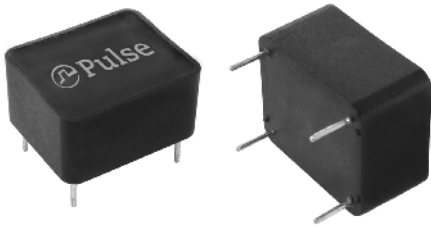

- Transformer for isolating the AC line voltage to an IC A/D input
- 3000 VAC Reinforced Isolation
- Low Phase shift, less than $\pm 1.5^\circ$
- Small Size
- Lower Power Consumption

Electrical Specifications @ 25°C - Operating Temperature -40°C to +125°C

Part Number	Turns Ratio	INPUT VOLTAGE MAX (Vrms)	OUTPUT VOLTAGE MAX (Vrms)	Phase Shift	Freq(Hz)	HIPOT(VAC)
PA3000NL	1:1	3.0	3.0	$\pm 1.5^\circ$	50 or 60	3000

- NOTES:
- The transformer is design to provide isolation from the AC line voltage to an IC with a high input impedance, and minimum phase shift. The output sine wave will not be distorted if the input voltage does not exceed the maximum rating.
 - From the AC Voltage line, a resistor divider, R1 and R2, can be used to step the voltage down to below the maximum input voltage.
 - For R1, multiple lower value resistors can be used in series to reduce the voltage across each resistor .

Mechanical

Schematic

PA3000NL

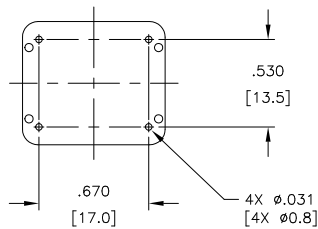
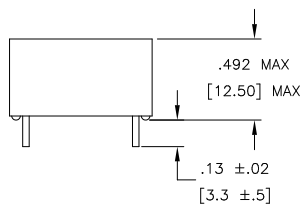
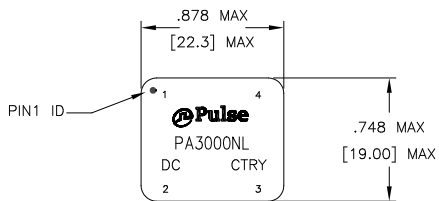

FINAL OUTLINE

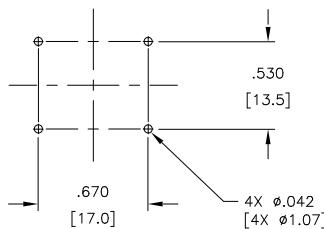

RECOMMENDED PAD LAYOUT

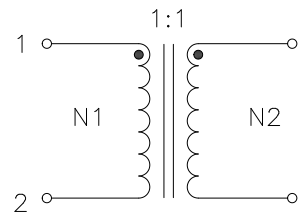

Weight10.86grams
Tray70/tray

Dimensions: $\frac{\text{Inches}}{\text{mm}}$

Unless otherwise specified,
all tolerances are $\pm \frac{.010}{0,25}$

VOLTAGE SENSE TRANSFORMER

PA3000NL

Recommended Application Circuit Resistor Values			
AC Line Voltage (Vrms)	R1 (Ω)	R2 (Ω)	RB (Ω)
120	50 K	750	500
240	100 K	750	500
408	200K	750	500

Typical Application Circuit

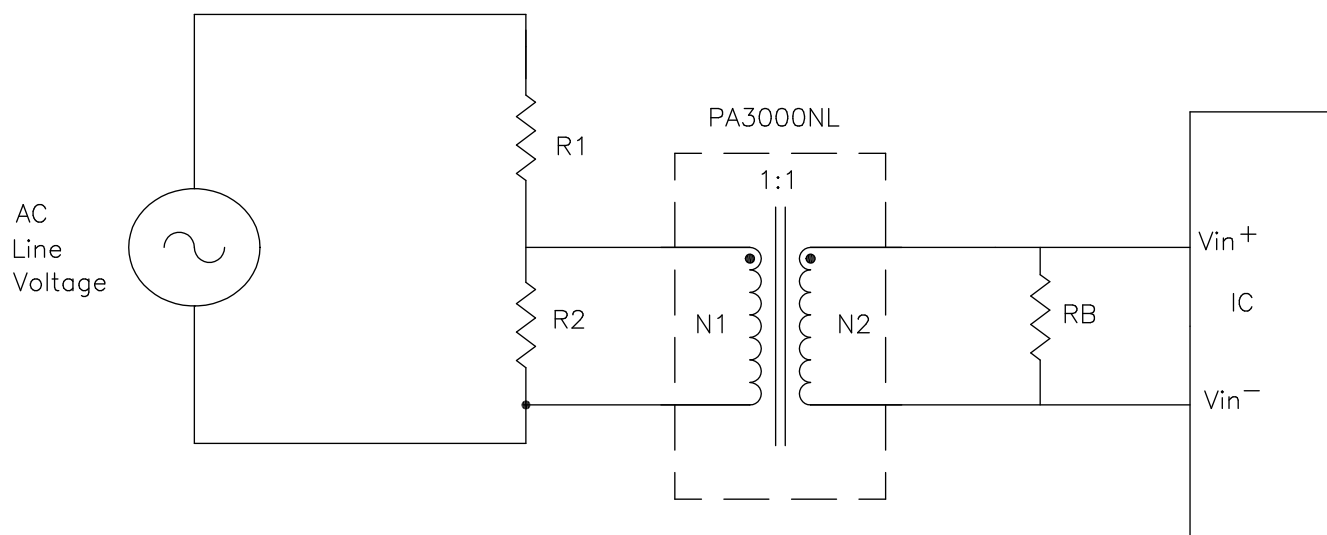

For More Information

Pulse Worldwide Headquarters

15255 Innovation Drive Ste 100
San Diego, CA 92128
U.S.A.

Pulse Europe

Pulse Electronics GmbH
Am Rottland 12
58540 Meinerzhagen
Germany

Pulse China Headquarters

Pulse Electronics (ShenZhen) CO., LTD
D708, Shenzhen Academy of
Aerospace Technology,
The 10th Keji South Road,
Nanshan District, Shenzhen, P.R.
China 518057

Pulse North China

Room 2704/2705
Super Ocean Finance Ctr.
2067 Yan An Road West
Shanghai 200336
China

Pulse South Asia

3 Fraser Street
0428 DUO Tower
Singapore 189352

Pulse North Asia

1F, No.111
Xiyuan Road
Zhongli District
Taoyuan City 32057
Taiwan (R.O.C)

Tel: 858 674 8100
Fax: 858 674 8262

Tel: 49 2354 777 100
Fax: 49 2354 777 168

Tel: 86 755 33966678
Fax: 86 755 33966700

Tel: 86 21 62787060
Fax: 86 2162786973

Tel: 65 6287 8998
Fax: 65 6280 0080

Tel: 886 3 4356768
Fax: 886 3 4356820

Performance warranty of products offered on this data sheet is limited to the parameters specified. Data is subject to change without notice. Other brand and product names mentioned herein may be trademarks or registered trademarks of their respective owners. © Copyright, 2019. Pulse Electronics, Inc. All rights reserved.