

MC74VHC125

Quad Bus Buffer with 3-State Control Inputs

The MC74VHC125 is a high speed CMOS quad bus buffer fabricated with silicon gate CMOS technology. It achieves high speed operation similar to equivalent Bipolar Schottky TTL while maintaining CMOS low power dissipation.

The MC74VHC125 requires the 3-state control input (\overline{OE}) to be set High to place the output into the high impedance state.

The internal circuit is composed of three stages, including a buffer output which provides high noise immunity and stable output. The inputs tolerate voltages up to 7 V, allowing the interface of 5 V systems to 3 V systems.

Features

- High Speed: $t_{PD} = 3.8\text{ns}$ (Typ) at $V_{CC} = 5\text{V}$
- Low Power Dissipation: $I_{CC} = 4\ \mu\text{A}$ (Max) at $T_A = 25^\circ\text{C}$
- High Noise Immunity: $V_{NIH} = V_{NIL} = 28\% V_{CC}$
- Power Down Protection Provided on Inputs
- Balanced Propagation Delays
- Designed for 2 V to 5.5 V Operating Range
- Low Noise: $V_{OLP} = 0.8\text{V}$ (Max)
- Pin and Function Compatible with Other Standard Logic Families
- Latchup Performance Exceeds 300 mA
- ESD Performance: Human Body Model; $> 2000\text{V}$,
Machine Model; $> 200\text{V}$
- Chip Complexity: 72 FETs or 18 Equivalent Gates
- NLV Prefix for Automotive and Other Applications Requiring Unique Site and Control Change Requirements; AEC-Q100 Qualified and PPAP Capable
- These Devices are Pb-Free, Halogen Free/BFR Free and are RoHS Compliant

LOGIC DIAGRAM

Active-Low Output Enables

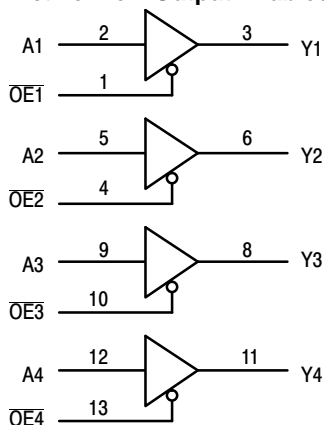

FUNCTION TABLE

| VHC125 | | |
|--------|-----------------|--------|
| Inputs | | Output |
| A | \overline{OE} | Y |
| H | L | H |
| L | L | L |
| X | H | Z |



ON Semiconductor®

www.onsemi.com

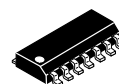

14-LEAD SOIC
D SUFFIX
CASE 751A

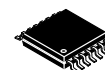

14-LEAD TSSOP
DT SUFFIX
CASE 948G

PIN CONNECTION AND MARKING DIAGRAM

(Top View)

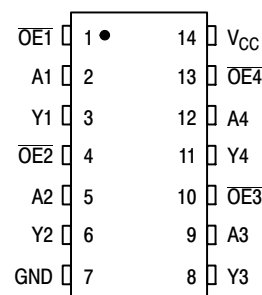

DEVICE MARKING INFORMATION

See general marking information in the device marking section on page 6 of this data sheet.

ORDERING INFORMATION

See detailed ordering and shipping information in the package dimensions section on page 2 of this data sheet.

MC74VHC125

MAXIMUM RATINGS

| Symbol | Parameter | Value | Unit |
|------------------|--|------------------------------|------|
| V _{CC} | DC Supply Voltage | -0.5 to +7.0 | V |
| V _{in} | DC Input Voltage | -0.5 to +7.0 | V |
| V _{out} | DC Output Voltage | -0.5 to V _{CC} +0.5 | V |
| I _{IK} | Input Diode Current | - 20 | mA |
| I _{OK} | Output Diode Current | ± 20 | mA |
| I _{out} | DC Output Current, per Pin | ± 25 | mA |
| I _{CC} | DC Supply Current, V _{CC} and GND Pins | ± 50 | mA |
| P _D | Power Dissipation in Still Air, SOIC Packages† TSSOP Package† | 500 450 | mW |
| T _{stg} | Storage Temperature | -65 to +150 | °C |

This device contains protection circuitry to guard against damage due to high static voltages or electric fields. However, precautions must be taken to avoid applications of any voltage higher than maximum rated voltages to this high-impedance circuit. For proper operation, V_{in} and V_{out} should be constrained to the range GND ≤ (V_{in} or V_{out}) ≤ V_{CC}. Unused inputs must always be tied to an appropriate logic voltage level (e.g., either GND or V_{CC}). Unused outputs must be left open.

Stresses exceeding those listed in the Maximum Ratings table may damage the device. If any of these limits are exceeded, device functionality should not be assumed, damage may occur and reliability may be affected.

†Derating - SOIC Packages: - 7 mW/°C from 65° to 125°C
TSSOP Package: - 6.1 mW/°C from 65° to 125°C

RECOMMENDED OPERATING CONDITIONS

| Symbol | Parameter | Min | Max | Unit |
|---------------------------------|--|--------|-----------------|------|
| V _{CC} | DC Supply Voltage | 2.0 | 5.5 | V |
| V _{in} | DC Input Voltage | 0 | 5.5 | V |
| V _{out} | DC Output Voltage | 0 | V _{CC} | V |
| T _A | Operating Temperature, All Package Types | -55 | +125 | °C |
| t _r , t _f | Input Rise and Fall Time V _{CC} = 3.3 V ± 0.3 V V _{CC} = 5.0 V ± 0.5 V | 0 0 | 100 20 | ns/V |

Functional operation above the stresses listed in the Recommended Operating Ranges is not implied. Extended exposure to stresses beyond the Recommended Operating Ranges limits may affect device reliability.

ORDERING INFORMATION

| Device | Package | Shipping† |
|-------------------|-----------------------|--------------------|
| MC74VHC125DG | SOIC-14 (Pb-Free) | 55 Units / Rail |
| NLV74VHC125DG* | SOIC-14 (Pb-Free) | 55 Units / Rail |
| MC74VHC125DR2G | SOIC-14 (Pb-Free) | 2500 / Tape & Reel |
| NLV74VHC125DR2G* | SOIC-14 (Pb-Free) | 2500 / Tape & Reel |
| MC74VHC125DTR2G | TSSOP-14 (Pb-Free) | 2500 / Tape & Reel |
| NLV74VHC125DTR2G* | TSSOP-14 (Pb-Free) | 2500 / Tape & Reel |

†For information on tape and reel specifications, including part orientation and tape sizes, please refer to our Tape and Reel Packaging Specifications Brochure, BRD8011/D.

*NLV Prefix for Automotive and Other Applications Requiring Unique Site and Control Change Requirements; AEC-Q100 Qualified and PPAP Capable.

MC74VHC125

DC ELECTRICAL CHARACTERISTICS

| Symbol | Parameter | Test Conditions | V _{CC} (V) | T _A = 25°C | | | T _A ≤ 85°C | | T _A ≤ 125°C | | Unit |
|-----------------|---|--|------------------------|-----------------------|-----|-----------|-----------------------|------|------------------------|------|------|
| | | | | Min | Typ | Max | Min | Max | Min | Max | |
| V _{IH} | Minimum High-Level Input Voltage | | 2.0 | 1.5 | | | 1.5 | | 1.5 | | V |
| | | | 3.0 | 2.1 | | | 2.1 | | 2.1 | | |
| | | | 4.5 | 3.15 | | | 3.15 | | 3.15 | | |
| | | | 5.5 | 3.85 | | | 3.85 | | 3.85 | | |
| V _{IL} | Maximum Low-Level Input Voltage | | 2.0 | | | 0.5 | | 0.5 | | 0.5 | V |
| | | | 3.0 | | | 0.9 | | 0.9 | | 0.9 | |
| | | | 4.5 | | | 1.35 | | 1.35 | | 1.35 | |
| | | | 5.5 | | | 1.65 | | 1.65 | | 1.65 | |
| V _{OH} | Minimum High-Level Output Voltage V _{IN} = V _{IH} or V _{IL} | V _{IN} = V _{IH} or V _{IL} I _{OH} = -50 μA | 2.0 | 1.9 | 2.0 | | 1.9 | | 1.9 | | V |
| | | | 3.0 | 2.9 | 3.0 | | 2.9 | | 2.9 | | |
| | | V _{IN} = V _{IH} or V _{IL} I _{OH} = -4 mA I _{OH} = -8 mA | 3.0 | 2.58 | | | 2.48 | | 2.34 | | V |
| | | | 4.5 | 3.94 | | | 3.80 | | 3.66 | | |
| V _{OL} | Maximum Low-Level Output Voltage V _{IN} = V _{IH} or V _{IL} | V _{IN} = V _{IH} or V _{IL} I _{OL} = 50 μA | 2.0 | | 0.0 | 0.1 | | 0.1 | | 0.1 | V |
| | | | 3.0 | | 0.0 | 0.1 | | 0.1 | | 0.1 | |
| | | V _{IN} = V _{IH} or V _{IL} I _{OL} = 4 mA I _{OL} = 8 mA | 3.0 | | | 0.36 | | 0.44 | | 0.52 | V |
| | | | 4.5 | | | 0.36 | | 0.44 | | 0.52 | |
| I _{OZ} | Maximum 3-State Leakage Current | V _{IN} = V _{IH} or V _{IL} V _{OUT} = V _{CC} or GND | 5.5 | | | ±0.2 5 | | ±2.5 | | ±2.5 | μA |
| I _{IN} | Maximum Input Leakage Current | V _{IN} = 5.5V or GND | 0 to 5.5 | | | ±0.1 | | ±1.0 | | ±1.0 | μA |
| I _{CC} | Maximum Quiescent Supply Current | V _{IN} = V _{CC} or GND | 5.5 | | | 4.0 | | 40 | | 40 | μA |

Product parametric performance is indicated in the Electrical Characteristics for the listed test conditions, unless otherwise noted. Product performance may not be indicated by the Electrical Characteristics if operated under different conditions.

MC74VHC125

AC ELECTRICAL CHARACTERISTICS (Input $t_r = t_f = 3.0$ ns)

| Symbol | Parameter | Test Conditions | $T_A = 25^\circ\text{C}$ | | | $T_A = \leq 85^\circ\text{C}$ | | $T_A = \leq 125^\circ\text{C}$ | | Unit |
|----------------------------|---|--|--------------------------|-----|------|-------------------------------|------|--------------------------------|------|------|
| | | | Min | Typ | Max | Min | Max | Min | Max | |
| t_{PLH} , t_{PHL} | Maximum Propagation Delay, A to Y | $V_{CC} = 3.3 \pm 0.3\text{V}$ $C_L = 15$ pF | | 5.6 | 8.0 | 1.0 | 9.5 | 1.0 | 12.0 | ns |
| | | $C_L = 50$ pF | | 8.1 | 11.5 | 1.0 | 13.0 | 1.0 | 16.0 | |
| | | $V_{CC} = 5.0 \pm 0.5\text{V}$ $C_L = 15$ pF | | 3.8 | 5.5 | 1.0 | 6.5 | 1.0 | 8.5 | |
| | | $C_L = 50$ pF | | 5.3 | 7.5 | 1.0 | 8.5 | 1.0 | 10.5 | |
| t_{PZL} , t_{PZH} | Maximum Output Enable Time, OE to Y | $V_{CC} = 3.3 \pm 0.3\text{V}$ $C_L = 15$ pF | | 5.4 | 8.0 | 1.0 | 9.5 | 1.0 | 11.5 | ns |
| | | $R_L = 1$ k Ω $C_L = 50$ pF | | 7.9 | 11.5 | 1.0 | 13.0 | 1.0 | 15.0 | |
| | | $V_{CC} = 5.0 \pm 0.5\text{V}$ $C_L = 15$ pF | | 3.6 | 5.1 | 1.0 | 6.0 | 1.0 | 7.5 | |
| | | $R_L = 1$ k Ω $C_L = 50$ pF | | 5.1 | 7.1 | 1.0 | 8.0 | 1.0 | 9.5 | |
| t_{PLZ} , t_{PHZ} | Maximum Output Disable Time, OE to Y | $V_{CC} = 3.3 \pm 0.3\text{V}$ $C_L = 50$ pF | | 9.5 | 13.2 | 1.0 | 15.0 | 1.0 | 18.0 | ns |
| | | $R_L = 1$ k Ω | | | | | | | | |
| | | $V_{CC} = 5.0 \pm 0.5\text{V}$ $C_L = 50$ pF | | 6.1 | 8.8 | 1.0 | 10.0 | 1.0 | 12.0 | |
| | | $R_L = 1$ k Ω | | | | | | | | |
| t_{OSLH} , t_{OSHL} | Output-to-Output Skew | $V_{CC} = 3.3 \pm 0.3\text{V}$ $C_L = 50$ pF | | | 1.5 | | 1.5 | | 1.5 | ns |
| | | (Note 1) | | | | | | | | |
| | | $V_{CC} = 5.0 \pm 0.5\text{V}$ $C_L = 50$ pF | | | 1.0 | | 1.0 | | 1.0 | |
| | | (Note 1) | | | | | | | | |
| C_{in} | Maximum Input Capacitance | | | 4 | 10 | | 10 | | 10 | pF |
| C_{out} | Maximum Three-State Output Capacitance (Output in High Impedance State) | | | 6 | | | | | | pF |

| C_{PD} | Power Dissipation Capacitance (Note 2) | Typical @ 25°C , $V_{CC} = 5.0$ V | | pF |
|----------|--|---|----|----|
| | | | 14 | |
| | | | | |

- Parameter guaranteed by design. $t_{OSLH} = |t_{PLHm} - t_{PLHn}|$, $t_{OSHL} = |t_{PHLm} - t_{PHLn}|$.
- C_{PD} is defined as the value of the internal equivalent capacitance which is calculated from the operating current consumption without load. Average operating current can be obtained by the equation: $I_{CC(OPR)} = C_{PD} \cdot V_{CC} \cdot f_{in} + I_{CC}/4$ (per buffer). C_{PD} is used to determine the no-load dynamic power consumption; $P_D = C_{PD} \cdot V_{CC}^2 \cdot f_{in} + I_{CC} \cdot V_{CC}$.

NOISE CHARACTERISTICS (Input $t_r = t_f = 3.0$ ns, $C_L = 50$ pF, $V_{CC} = 5.0$ V)

| Symbol | Characteristic | $T_A = 25^\circ\text{C}$ | | Unit |
|-----------|--|--------------------------|------|------|
| | | Typ | Max | |
| V_{OLP} | Quiet Output Maximum Dynamic V_{OL} | 0.3 | 0.8 | V |
| V_{OLV} | Quiet Output Minimum Dynamic V_{OL} | -0.3 | -0.8 | V |
| V_{IHD} | Minimum High Level Dynamic Input Voltage | | 3.5 | V |
| V_{ILD} | Maximum Low Level Dynamic Input Voltage | | 1.5 | V |

MC74VHC125

SWITCHING WAVEFORMS

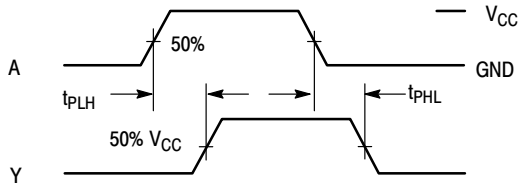

Figure 1.

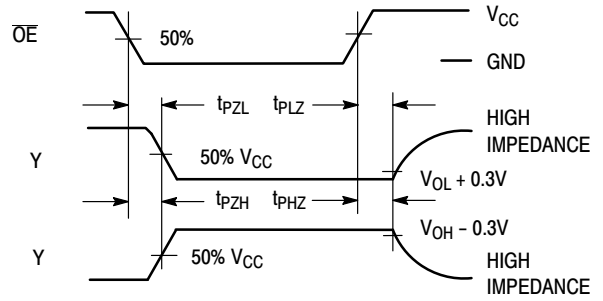
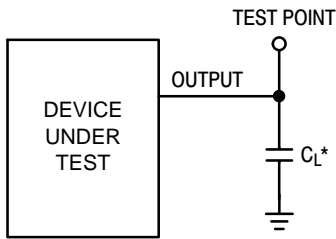
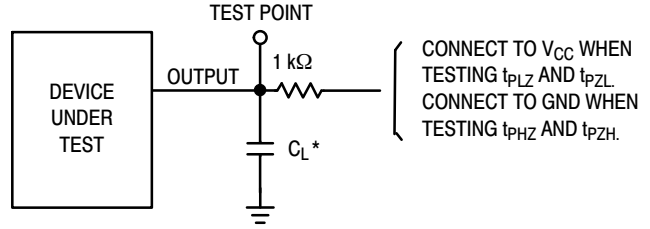

Figure 2.



*Includes all probe and jig capacitance

Figure 3. Test Circuit



*Includes all probe and jig capacitance

Figure 4. Test Circuit

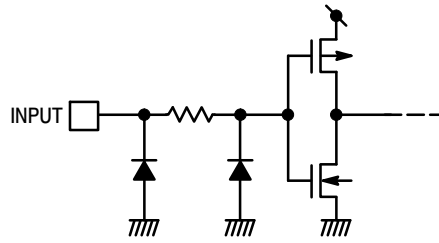
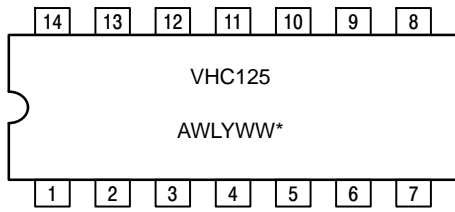

Figure 5. Input Equivalent Circuit

MC74VHC125

MARKING DIAGRAMS (Top View)



**14-LEAD SOIC
D SUFFIX
CASE 751A**

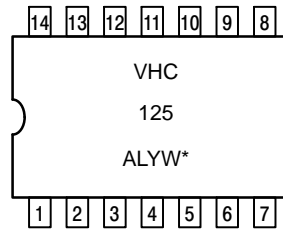

**14-LEAD TSSOP
DT SUFFIX
CASE 948G**

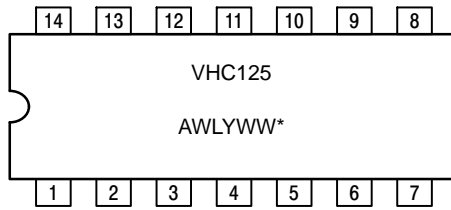

**14-LEAD SOIC EIAJ
M SUFFIX
CASE 965**

*See Applications Note AND8004/D for date code and traceability information.

MECHANICAL CASE OUTLINE PACKAGE DIMENSIONS

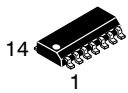

SCALE 1:1

SOIC-14 NB
CASE 751A-03
ISSUE L

DATE 03 FEB 2016

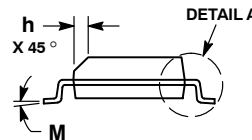
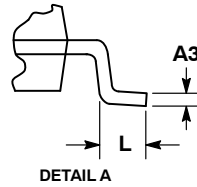
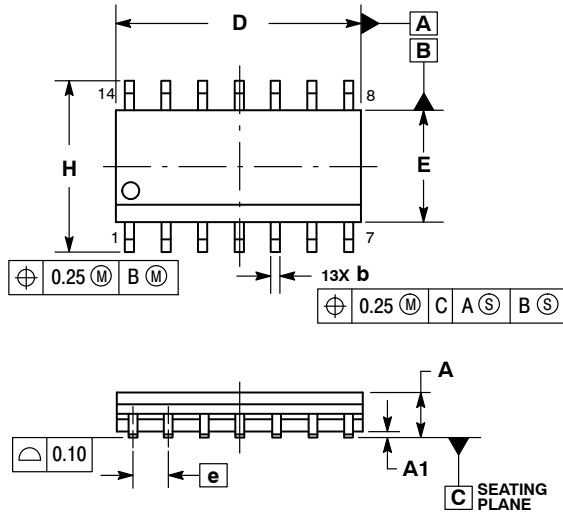

NOTES:

1. DIMENSIONING AND TOLERANCING PER ASME Y14.5M, 1994.
2. CONTROLLING DIMENSION: MILLIMETERS.
3. DIMENSION b DOES NOT INCLUDE DAMBAR PROTRUSION. ALLOWABLE PROTRUSION SHALL BE 0.13 TOTAL IN EXCESS OF AT MAXIMUM MATERIAL CONDITION.
4. DIMENSIONS D AND E DO NOT INCLUDE MOLD PROTRUSIONS.
5. MAXIMUM MOLD PROTRUSION 0.15 PER SIDE.

| DIM | MILLIMETERS | | INCHES | |
|-----|-------------|------|-----------|-------|
| | MIN | MAX | MIN | MAX |
| A | 1.35 | 1.75 | 0.054 | 0.068 |
| A1 | 0.10 | 0.25 | 0.004 | 0.010 |
| A3 | 0.19 | 0.25 | 0.008 | 0.010 |
| b | 0.35 | 0.49 | 0.014 | 0.019 |
| D | 8.55 | 8.75 | 0.337 | 0.344 |
| E | 3.80 | 4.00 | 0.150 | 0.157 |
| e | 1.27 BSC | | 0.050 BSC | |
| H | 5.80 | 6.20 | 0.228 | 0.244 |
| h | 0.25 | 0.50 | 0.010 | 0.019 |
| L | 0.40 | 1.25 | 0.016 | 0.049 |
| M | 0° | 7° | 0° | 7° |

SOLDERING FOOTPRINT*

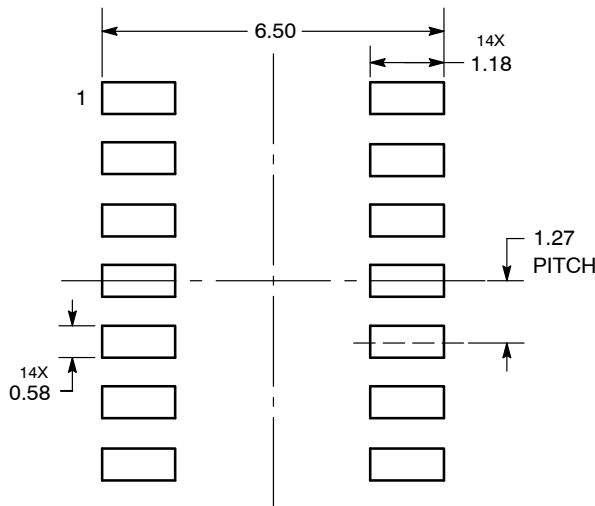

DIMENSIONS: MILLIMETERS

*For additional information on our Pb-Free strategy and soldering details, please download the ON Semiconductor Soldering and Mounting Techniques Reference Manual, SOLDERRM/D.

GENERIC MARKING DIAGRAM*

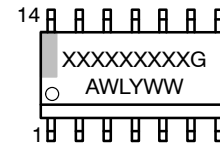

- XXXXXX = Specific Device Code
- A = Assembly Location
- WL = Wafer Lot
- Y = Year
- WW = Work Week
- G = Pb-Free Package

*This information is generic. Please refer to device data sheet for actual part marking. Pb-Free indicator, "G" or microdot "▪", may or may not be present. Some products may not follow the Generic Marking.

STYLES ON PAGE 2

| | | |
|------------------|-------------|--|
| DOCUMENT NUMBER: | 98ASB42565B | Electronic versions are uncontrolled except when accessed directly from the Document Repository. Printed versions are uncontrolled except when stamped "CONTROLLED COPY" in red. |
| DESCRIPTION: | SOIC-14 NB | PAGE 1 OF 2 |

onsemi and onsemi are trademarks of Semiconductor Components Industries, LLC dba onsemi or its subsidiaries in the United States and/or other countries. onsemi reserves the right to make changes without further notice to any products herein. onsemi makes no warranty, representation or guarantee regarding the suitability of its products for any particular purpose, nor does onsemi assume any liability arising out of the application or use of any product or circuit, and specifically disclaims any and all liability, including without limitation special, consequential or incidental damages. onsemi does not convey any license under its patent rights nor the rights of others.

SOIC-14
CASE 751A-03
ISSUE L

DATE 03 FEB 2016

STYLE 1:
 PIN 1. COMMON CATHODE
 2. ANODE/CATHODE
 3. ANODE/CATHODE
 4. NO CONNECTION
 5. ANODE/CATHODE
 6. NO CONNECTION
 7. ANODE/CATHODE
 8. ANODE/CATHODE
 9. ANODE/CATHODE
 10. NO CONNECTION
 11. ANODE/CATHODE
 12. ANODE/CATHODE
 13. NO CONNECTION
 14. COMMON ANODE

STYLE 2:
 CANCELLED

STYLE 3:
 PIN 1. NO CONNECTION
 2. ANODE
 3. ANODE
 4. NO CONNECTION
 5. ANODE
 6. NO CONNECTION
 7. ANODE
 8. ANODE
 9. ANODE
 10. NO CONNECTION
 11. ANODE
 12. ANODE
 13. NO CONNECTION
 14. COMMON CATHODE

STYLE 4:
 PIN 1. NO CONNECTION
 2. CATHODE
 3. CATHODE
 4. NO CONNECTION
 5. CATHODE
 6. NO CONNECTION
 7. CATHODE
 8. CATHODE
 9. CATHODE
 10. NO CONNECTION
 11. CATHODE
 12. CATHODE
 13. NO CONNECTION
 14. COMMON ANODE

STYLE 5:
 PIN 1. COMMON CATHODE
 2. ANODE/CATHODE
 3. ANODE/CATHODE
 4. ANODE/CATHODE
 5. ANODE/CATHODE
 6. NO CONNECTION
 7. COMMON ANODE
 8. COMMON CATHODE
 9. ANODE/CATHODE
 10. ANODE/CATHODE
 11. ANODE/CATHODE
 12. ANODE/CATHODE
 13. NO CONNECTION
 14. COMMON ANODE

STYLE 6:
 PIN 1. CATHODE
 2. CATHODE
 3. CATHODE
 4. CATHODE
 5. CATHODE
 6. CATHODE
 7. CATHODE
 8. ANODE
 9. ANODE
 10. ANODE
 11. ANODE
 12. ANODE
 13. ANODE
 14. ANODE

STYLE 7:
 PIN 1. ANODE/CATHODE
 2. COMMON ANODE
 3. COMMON CATHODE
 4. ANODE/CATHODE
 5. ANODE/CATHODE
 6. ANODE/CATHODE
 7. ANODE/CATHODE
 8. ANODE/CATHODE
 9. ANODE/CATHODE
 10. ANODE/CATHODE
 11. COMMON CATHODE
 12. COMMON ANODE
 13. ANODE/CATHODE
 14. ANODE/CATHODE

STYLE 8:
 PIN 1. COMMON CATHODE
 2. ANODE/CATHODE
 3. ANODE/CATHODE
 4. NO CONNECTION
 5. ANODE/CATHODE
 6. ANODE/CATHODE
 7. COMMON ANODE
 8. COMMON ANODE
 9. ANODE/CATHODE
 10. ANODE/CATHODE
 11. NO CONNECTION
 12. ANODE/CATHODE
 13. ANODE/CATHODE
 14. COMMON CATHODE

| | | |
|-------------------------|--------------------|---|
| DOCUMENT NUMBER: | 98ASB42565B | Electronic versions are uncontrolled except when accessed directly from the Document Repository. Printed versions are uncontrolled except when stamped "CONTROLLED COPY" in red. |
| DESCRIPTION: | SOIC-14 NB | PAGE 2 OF 2 |

onsemi and **ONSEMI** are trademarks of Semiconductor Components Industries, LLC dba **onsemi** or its subsidiaries in the United States and/or other countries. **onsemi** reserves the right to make changes without further notice to any products herein. **onsemi** makes no warranty, representation or guarantee regarding the suitability of its products for any particular purpose, nor does **onsemi** assume any liability arising out of the application or use of any product or circuit, and specifically disclaims any and all liability, including without limitation special, consequential or incidental damages. **onsemi** does not convey any license under its patent rights nor the rights of others.

MECHANICAL CASE OUTLINE PACKAGE DIMENSIONS

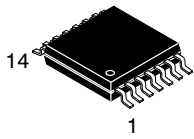

TSSOP-14 WB
CASE 948G
ISSUE C

DATE 17 FEB 2016

SCALE 2:1

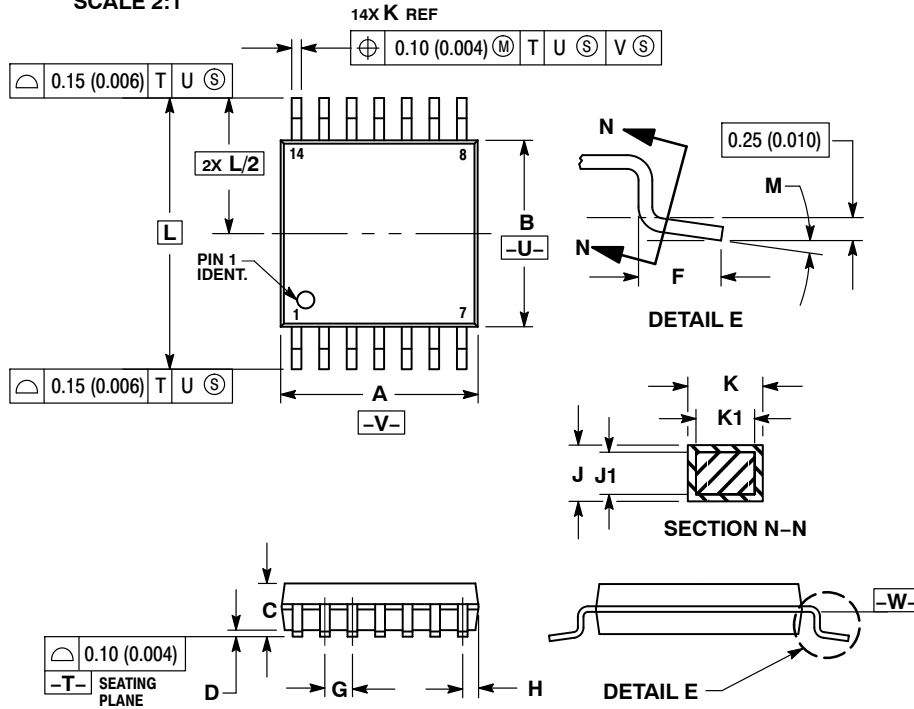

NOTES:

- DIMENSIONING AND TOLERANCING PER ANSI Y14.5M, 1982.
- CONTROLLING DIMENSION: MILLIMETER.
- DIMENSION A DOES NOT INCLUDE MOLD FLASH, PROTRUSIONS OR GATE BURRS. MOLD FLASH OR GATE BURRS SHALL NOT EXCEED 0.15 (0.006) PER SIDE.
- DIMENSION B DOES NOT INCLUDE INTERLEAD FLASH OR PROTRUSION. INTERLEAD FLASH OR PROTRUSION SHALL NOT EXCEED 0.25 (0.010) PER SIDE.
- DIMENSION K DOES NOT INCLUDE DAMBAR PROTRUSION. ALLOWABLE DAMBAR PROTRUSION SHALL BE 0.08 (0.003) TOTAL IN EXCESS OF THE K DIMENSION AT MAXIMUM MATERIAL CONDITION.
- TERMINAL NUMBERS ARE SHOWN FOR REFERENCE ONLY.
- DIMENSION A AND B ARE TO BE DETERMINED AT DATUM PLANE -W-.

| DIM | MILLIMETERS | | INCHES | |
|-----|-------------|------|-----------|-------|
| | MIN | MAX | MIN | MAX |
| A | 4.90 | 5.10 | 0.193 | 0.200 |
| B | 4.30 | 4.50 | 0.169 | 0.177 |
| C | --- | 1.20 | --- | 0.047 |
| D | 0.05 | 0.15 | 0.002 | 0.006 |
| F | 0.50 | 0.75 | 0.020 | 0.030 |
| G | 0.65 BSC | | 0.026 BSC | |
| H | 0.50 | 0.60 | 0.020 | 0.024 |
| J | 0.09 | 0.20 | 0.004 | 0.008 |
| J1 | 0.09 | 0.16 | 0.004 | 0.006 |
| K | 0.19 | 0.30 | 0.007 | 0.012 |
| K1 | 0.19 | 0.25 | 0.007 | 0.010 |
| L | 6.40 BSC | | 0.252 BSC | |
| M | 0° | 8° | 0° | 8° |

GENERIC MARKING DIAGRAM*

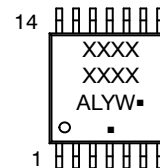

- A = Assembly Location
- L = Wafer Lot
- Y = Year
- W = Work Week
- = Pb-Free Package

(Note: Microdot may be in either location)

*This information is generic. Please refer to device data sheet for actual part marking. Pb-Free indicator, "G" or microdot "▪", may or may not be present. Some products may not follow the Generic Marking.

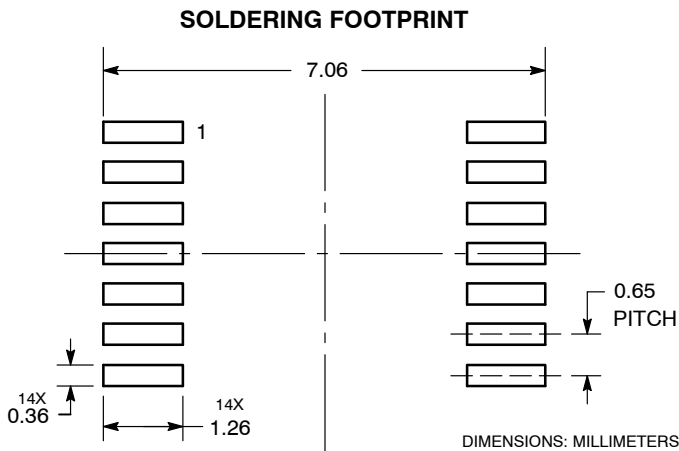

| | | |
|-------------------------|--------------------|--|
| DOCUMENT NUMBER: | 98ASH70246A | Electronic versions are uncontrolled except when accessed directly from the Document Repository. Printed versions are uncontrolled except when stamped "CONTROLLED COPY" in red. |
| DESCRIPTION: | TSSOP-14 WB | PAGE 1 OF 1 |

onsemi and onsemi are trademarks of Semiconductor Components Industries, LLC dba onsemi or its subsidiaries in the United States and/or other countries. onsemi reserves the right to make changes without further notice to any products herein. onsemi makes no warranty, representation or guarantee regarding the suitability of its products for any particular purpose, nor does onsemi assume any liability arising out of the application or use of any product or circuit, and specifically disclaims any and all liability, including without limitation special, consequential or incidental damages. onsemi does not convey any license under its patent rights nor the rights of others.

onsemi, **Onsemi**, and other names, marks, and brands are registered and/or common law trademarks of Semiconductor Components Industries, LLC dba "**onsemi**" or its affiliates and/or subsidiaries in the United States and/or other countries. **onsemi** owns the rights to a number of patents, trademarks, copyrights, trade secrets, and other intellectual property. A listing of **onsemi**'s product/patent coverage may be accessed at www.onsemi.com/site/pdf/Patent-Marking.pdf. **onsemi** reserves the right to make changes at any time to any products or information herein, without notice. The information herein is provided "as-is" and **onsemi** makes no warranty, representation or guarantee regarding the accuracy of the information, product features, availability, functionality, or suitability of its products for any particular purpose, nor does **onsemi** assume any liability arising out of the application or use of any product or circuit, and specifically disclaims any and all liability, including without limitation special, consequential or incidental damages. Buyer is responsible for its products and applications using **onsemi** products, including compliance with all laws, regulations and safety requirements or standards, regardless of any support or applications information provided by **onsemi**. "Typical" parameters which may be provided in **onsemi** data sheets and/or specifications can and do vary in different applications and actual performance may vary over time. All operating parameters, including "Typicals" must be validated for each customer application by customer's technical experts. **onsemi** does not convey any license under any of its intellectual property rights nor the rights of others. **onsemi** products are not designed, intended, or authorized for use as a critical component in life support systems or any FDA Class 3 medical devices or medical devices with a same or similar classification in a foreign jurisdiction or any devices intended for implantation in the human body. Should Buyer purchase or use **onsemi** products for any such unintended or unauthorized application, Buyer shall indemnify and hold **onsemi** and its officers, employees, subsidiaries, affiliates, and distributors harmless against all claims, costs, damages, and expenses, and reasonable attorney fees arising out of, directly or indirectly, any claim of personal injury or death associated with such unintended or unauthorized use, even if such claim alleges that **onsemi** was negligent regarding the design or manufacture of the part. **onsemi** is an Equal Opportunity/Affirmative Action Employer. This literature is subject to all applicable copyright laws and is not for resale in any manner.

ADDITIONAL INFORMATION

TECHNICAL PUBLICATIONS:

Technical Library: www.onsemi.com/design/resources/technical-documentation
onsemi Website: www.onsemi.com

ONLINE SUPPORT: www.onsemi.com/support

For additional information, please contact your local Sales Representative at www.onsemi.com/support/sales