

REFERENCE SPECIFICATIONS

-NFC 93425 (in compliance with HE 501)

PHYSICAL CHARACTERISTICS

- INSULATOR MATERIAL: THERMOPLASTIC UL94V0
- CONTACT MATERIAL: BRASS,
GOLD OVER NICKEL
- ACCESSORIES: STEEL FOR METAL BRACKETS,
cadmium plated yellow passivation
THERMOPLASTIC UL94V0 FOR PLASTIC BRACKETS
BRASS FOR OTHERS ACCESSORIES,
cadmium plated yellow passivation
- SHELLS: STEEL,
cadmium plated yellow passivation

ELECTRICAL CHARACTERISTICS

- NOMINAL CURRENT: 7.5A
- CONTACT RESISTANCE: <=7.3 m Ohms
- CONTACT/CONTACT : >=1000 V
- CONTACT/GROUND : >=1200 V
- INSULATION RESISTANCE: >=5000 MOhms

ENVIRONMENTAL CHARACTERISTICS

- CLIMATIC CATEGORY: 55/125/56
TEMPERATURE RANGE -55°C TO +125°C
DAMP HEAT STEADY STATE 56 DAYS
SALT SPRAY 48 HOURS

MECHANICAL CHARACTERISTICS

- RETENTION AGAINST TORQUE: -Threaded insert:0.7 N.m min
-Female screw:0.5 N.m min

DBML25P500M

Series

Shell size: **E A B C D**
(see sheet 3)

Front accessory definition
(see sheet 2)

- Blank** :without accessory
- L** :threaded insert M3
- O** :threaded insert UNC 4-40
- V** :female screw UNC 4-40

Layout of contacts (see sheet 3)

9,15,25,37,50

Contacts

- P** :Pin

Termination type

- 5** Right angle/Europe standard

Plating

- 00** Right angle 500 matings/unmatings
- 43** Right angle 500 matings/unmatings
for harsh environment

PCB accessories definition(see sheet 2)

- Blank** :Plastic brackets
- C** :Without brackets
- M** :Metal brackets

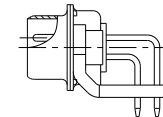
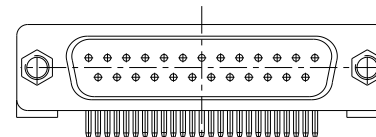

25 WAY for Example

rev	ccn no	dr	date
A	LS06-0174	MPE	2006/11/14
B	LS07-0068	MPE	2007/03/02
C	LS08-0119	MPE	2008/04/29
-	-	-	-
-	-	-	-

www.fciconnect.com		surface	tolerance std	projection	mm
		ISO 1302	ISO 406 ISO 1101		
		TOLERANCES UNLESS OTHERWISE SPECIFIED			
		ANGULAR	0.X ±0.3	size	A2
		LINEAR	0.XX ±0.1	Scale	2:1
		0° ±2'	0.XXX ±0.05	ECN	LS08-0119
		Product family		Spec ref	
		SUB MALE DM HE501 series		ang no	C01-8637-1740
		with right angle contact		Rev.	C
catalog no		CUSTOMER		sheet 1 of 9	

Copyright FCI

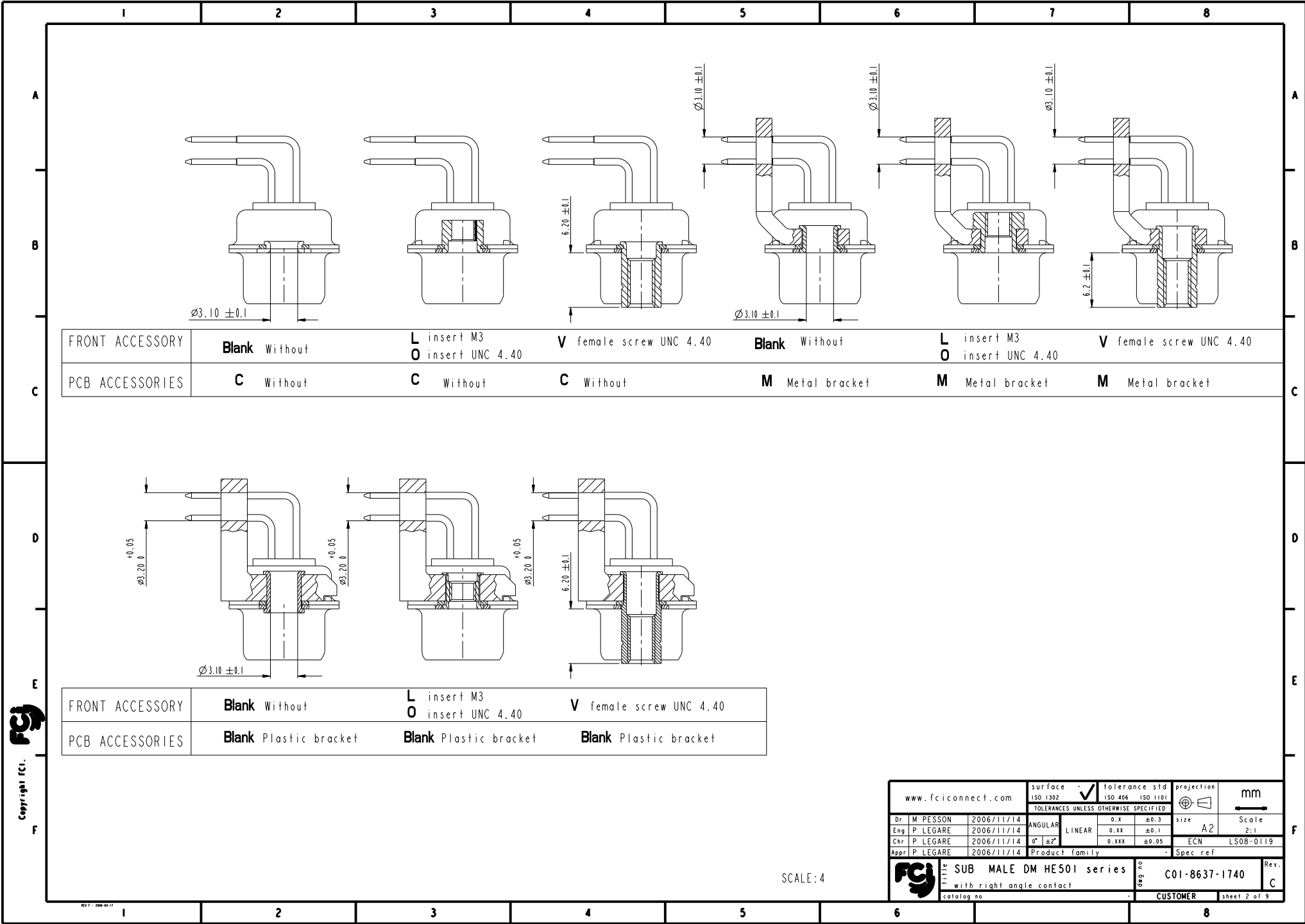

FRONT ACCESSORY	Blank Without	L insert M3 O insert UNC 4.40	V female screw UNC 4.40	Blank Without	L insert M3 O insert UNC 4.40	V female screw UNC 4.40
PCB ACCESSORIES	C Without	C Without	C Without	M Metal bracket	M Metal bracket	M Metal bracket

FRONT ACCESSORY	Blank Without	L insert M3 O insert UNC 4.40	V female screw UNC 4.40
PCB ACCESSORIES	Blank Plastic bracket	Blank Plastic bracket	Blank Plastic bracket

www.fciconnect.com		surface - ISO 1302	tolerance std ISO 406 - ISO 1101	projection mm
		TOLERANCES UNLESS OTHERWISE SPECIFIED		
Dr	M PESSON	2006/11/14	ANGULAR	0.X ±0.3
Eng	P LEGARE	2006/11/14	LINEAR	0.XX ±0.1
Chr	P LEGARE	2006/11/14	0° ±2°	0.XXX ±0.05
Appr	P LEGARE	2006/11/14	Product family	- Spec ref
SUB MALE DM HE501 series		ang no	C01-8637-1740	
with right angle contact		Rev.	C	
catalog no		CUSTOMER		sheet 2 of 9

SCALE: 4

Copyright fci.

PART NUMBER	FRONT ACCESSORY	PCB ACCESSORY
D*MxxP500C	without	without
D*MLxxP500C	insert M3	without
D*MOxxP500C	insert UNC 4.40	without
D*MVxxP500C	female screw UNC 4.40	without
D*MxxP500M	without	Metal bracket
D*MLxxP500M	insert M3	Metal bracket
D*MOxxP500M	insert UNC 4.40	Metal bracket
D*MVxxP500M	female screw UNC 4.40	Metal bracket
D*MxxP500	without	Plastic bracket
D*MLxxP500	insert M3	Plastic bracket
D*MOxxP500	insert UNC 4.40	Plastic bracket
D*MVxxP500	female screw UNC 4.40	Plastic bracket

shell size	Contact number
X	09
E	15
A	25
B	37
C	50
D	

PART NUMBER	FRONT ACCESSORY	PCB ACCESSORY
D*MxxP543C	without	without
D*MLxxP543C	insert M3	without
D*MOxxP543C	insert UNC 4.40	without
D*MVxxP543C	female screw UNC 4.40	without
D*MxxP543M	without	Metal bracket
D*MLxxP543M	insert M3	Metal bracket
D*MOxxP543M	insert UNC 4.40	Metal bracket
D*MVxxP543M	female screw UNC 4.40	Metal bracket
D*MxxP543	without	Plastic bracket
D*MLxxP543	insert M3	Plastic bracket
D*MOxxP543	insert UNC 4.40	Plastic bracket
D*MVxxP543	female screw UNC 4.40	Plastic bracket

CROSS REFERENCES HE501 and FCI

HE501 P/N	FCI P/N	FRONT ACCESSORY	PCB ACCESSORY
HE501PxxVP6	D*MxxP500	without	Plastic bracket
HE501MxxVP6	D*MxxP500M	without	Metal bracket

Copyright FCI

www.fciconnect.com		surface - ISO 1302	tolerance std ISO 406 ISO 1101	projection mm
		TOLERANCES UNLESS OTHERWISE SPECIFIED		
Dr M PESSON	2006/11/14	ANGULAR	0.X ±0.3	size A2 Scale 2:1
Eng P LEGARE	2006/11/14	LINEAR	0.XX ±0.1	ECN LS08-0119
Chr P LEGARE	2006/11/14	0° ±2°	0.XXX ±0.05	
Appr P LEGARE	2006/11/14	Product family	Spec ref	
SUB MALE DM HE501 series		ang no	C01-8637-1740	
with right angle contact		Rev.	C	
catalog no		CUSTOMER	sheet 3 of 9	

DIMENSION FOR SHELL E,A,B,C WITHOUT BRACKET

Dimensions are in millimeters

Shell size	Number of contacts	A ^{+0.76} ₋₀	B ^{+0.25} ₋₀	C ±0.12	F ^{+0.57} ₋₀	G ^{+0.25} ₋₀	H ^{+0.51} ₋₀	L ^{+0.22} ₋₀
E	09	30.43	16.79	24.99	10.47	5.9 ^{+0.15} ₋₀	19.02	0.80
A	15	38.76	25.12	33.32	10.47	5.9 ^{+0.15} ₋₀	27.25	0.80
B	25	52.65	38.84	47.04	10.43	5.7 ^{+0.25} ₋₀	41.02	0.80
C	37	68.94	55.30	63.50	10.56	5.7 ^{+0.25} ₋₀	57.45	0.90

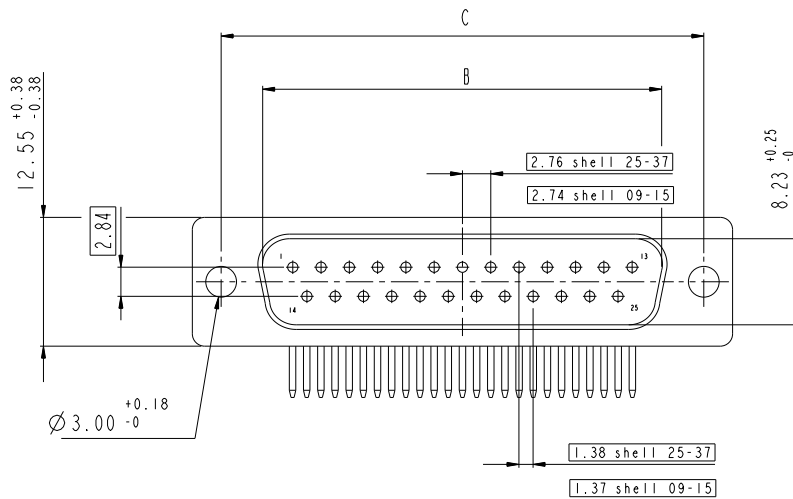
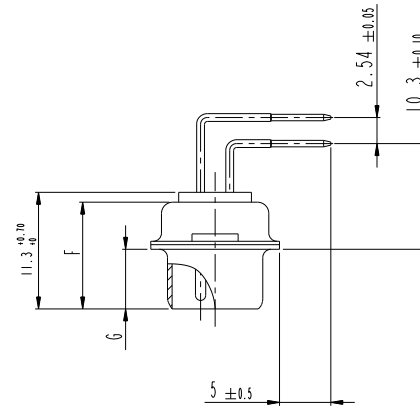
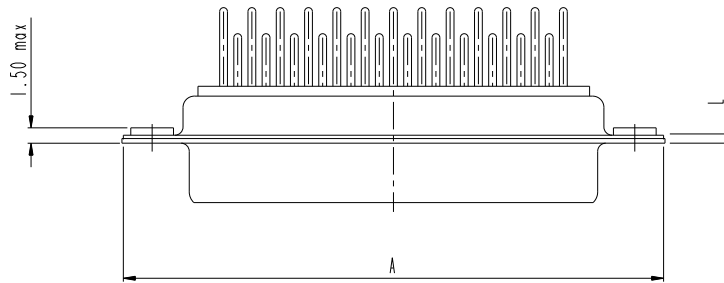
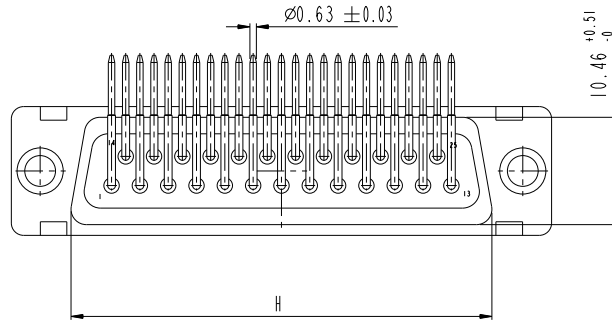

LAYOUT DIMENSIONS

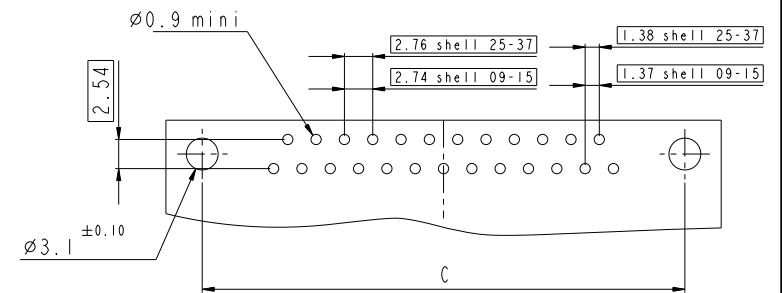

SCALE: 3

www.fciconnect.com		surface -	tolerance std	projection	mm
		ISO 1302	ISO 406 ISO 1101		
		TOLERANCES UNLESS OTHERWISE SPECIFIED			
Dr	M PESSON	2006/11/14	ANGULAR	0.X ±0.3	size A2 Scale 2:1
Eng	P LEGARE	2006/11/14	LINEAR	0.XX ±0.1	ECN LS08-0119
Chr	P LEGARE	2006/11/14	0° ±2°	0.XXX ±0.05	
Appr	P LEGARE	2006/11/14	Product family	-	Spec ref
		SUB MALE DM HE501 series		ang no	C01-8637-1740
		with right angle contact		Rev.	C
catalog no		CUSTOMER		sheet 4 of 9	

Copyright FCI, FCI

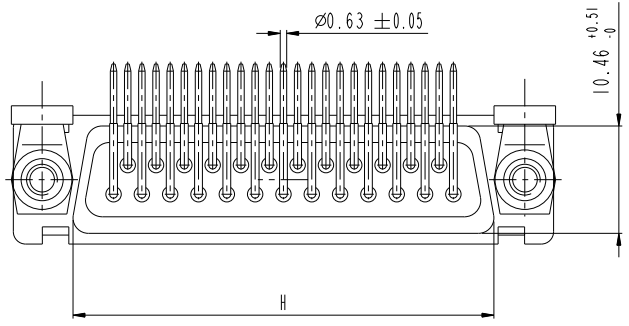

DIMENSION FOR SHELL E,A,B,C WITH METAL BRACKET

Dimensions are in millimeters

Shell size	Number of contacts	A $^{+0.76}_{-0}$	B $^{+0.25}_{-0}$	C ± 0.12	F $^{+0.57}_{-0}$	G $^{+0.25}_{-0}$	H $^{+0.51}_{-0}$	L $^{+0.22}_{-0}$
E	09	30.43	16.79	24.99	10.47	5.9 $^{+0.15}_{-0}$	19.02	0.80
A	15	38.76	25.12	33.32	10.47	5.9 $^{+0.15}_{-0}$	27.25	0.80
B	25	52.65	38.84	47.04	10.43	5.7 $^{+0.25}_{-0}$	41.02	0.80
C	37	68.94	55.30	63.50	10.56	5.7 $^{+0.25}_{-0}$	57.45	0.90

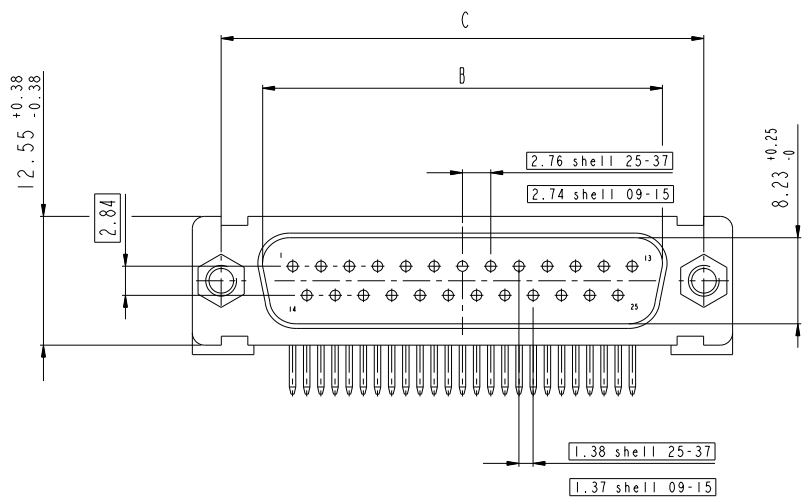
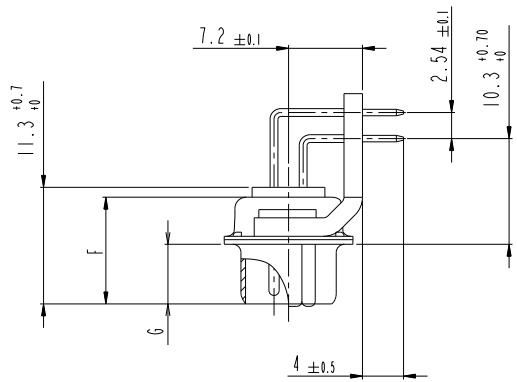
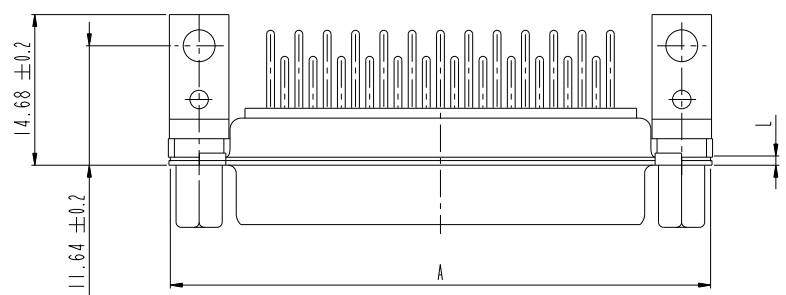

LAYOUT DIMENSIONS

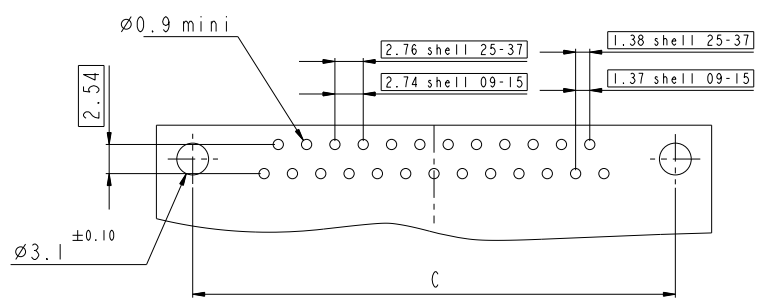

Copyright fci. FCI

www.fciconnect.com		surface - ISO 1302	tolerance std ISO 406 ISO 1101	projection mm
		TOLERANCES UNLESS OTHERWISE SPECIFIED		
Dr M PESSON	2006/11/14	ANGULAR	0.X ± 0.3	size A2 Scale 2:1
Eng P LEGARE	2006/11/14	LINEAR	0.XX ± 0.1	ECN LS08-0119
Chr P LEGARE	2006/11/14	$\sigma^{\circ} \pm 2^{\circ}$	0.XXX ± 0.05	
Appr P LEGARE	2006/11/14	Product family	-	Spec ref
SUB MALE DM HE501 series		ang no	C01-8637-1740	
with right angle contact		Rev.	C	
catalog no		CUSTOMER sheet 5 of 9		

SCALE: 3

DIMENSION FOR SHELL E,A,B,C WITH PLASTIC BRACKET

Dimensions are in millimeters

Shell size	Number of contacts	A $\begin{smallmatrix} +0.76 \\ -0 \end{smallmatrix}$	B $\begin{smallmatrix} +0.25 \\ -0 \end{smallmatrix}$	C ± 0.12	F $\begin{smallmatrix} +0.57 \\ -0 \end{smallmatrix}$	G $\begin{smallmatrix} +0.25 \\ -0 \end{smallmatrix}$	H $\begin{smallmatrix} +0.51 \\ -0 \end{smallmatrix}$	L $\begin{smallmatrix} +0.22 \\ -0 \end{smallmatrix}$
E	09	30.43	16.79	24.99	10.47	5.9 $\begin{smallmatrix} +0.15 \\ -0 \end{smallmatrix}$	19.02	0.80
A	15	38.76	25.12	33.32	10.47	5.9 $\begin{smallmatrix} +0.15 \\ -0 \end{smallmatrix}$	27.25	0.80
B	25	52.65	38.84	47.04	10.43	5.7 $\begin{smallmatrix} +0.25 \\ -0 \end{smallmatrix}$	41.02	0.80
C	37	68.94	55.30	63.50	10.56	5.7 $\begin{smallmatrix} +0.25 \\ -0 \end{smallmatrix}$	57.45	0.90

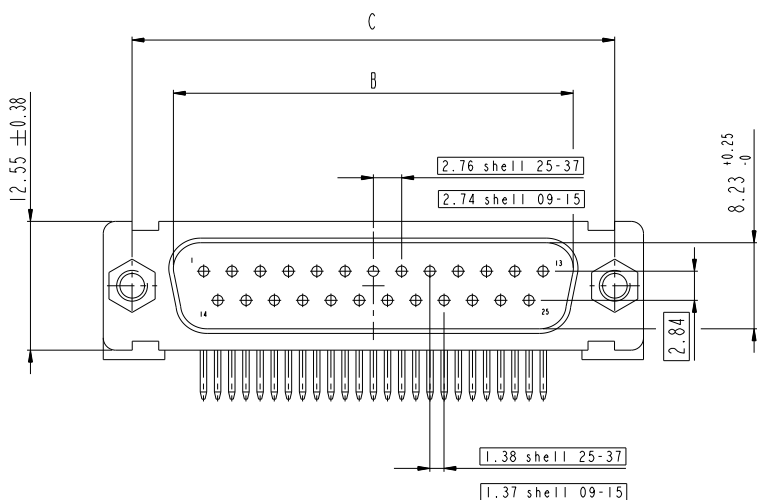
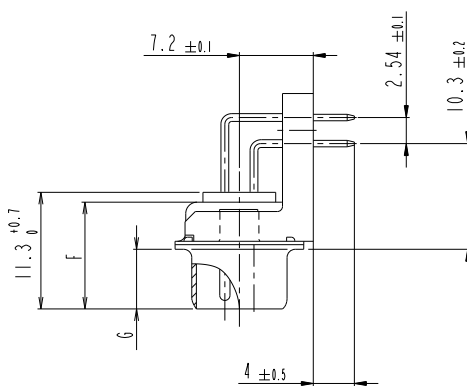
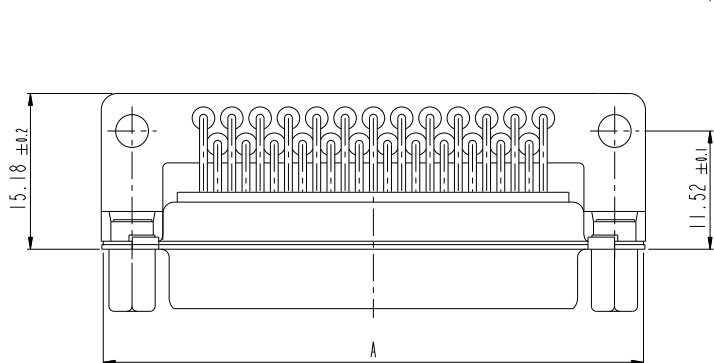
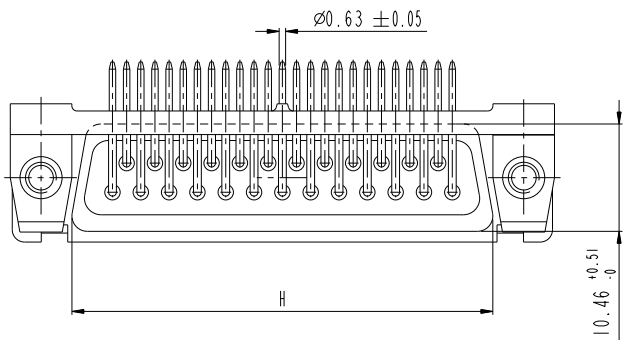

LAYOUT DIMENSIONS

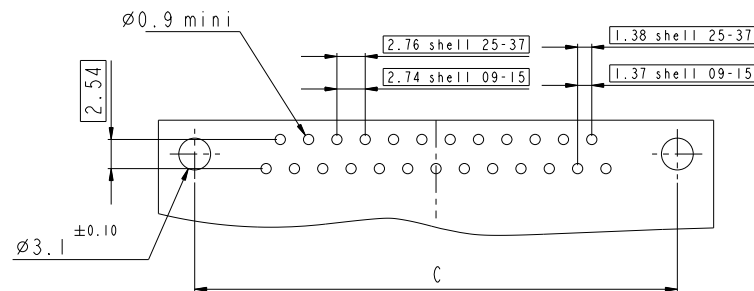

www.fciconnect.com		surface - ISO 1302	tolerance std ISO 406 ISO 1101	projection mm
		TOLERANCES UNLESS OTHERWISE SPECIFIED		
Dr M PESSON	2006/11/14	ANGULAR	0.X ± 0.3	size A2 Scale 2:1
Eng P LEGARE	2006/11/14	LINEAR	0.XX ± 0.1	ECN LS08-0119
Chr P LEGARE	2006/11/14	0° ± 2°	0.XXX ± 0.05	
Appr P LEGARE	2006/11/14	Product family		Spec ref
FCI SUB MALE DM HE501 series		ang no	C01-8637-1740	
with right angle contact		Rev.	C	
catalog no		CUSTOMER	sheet 6 of 9	

Copyright fci.

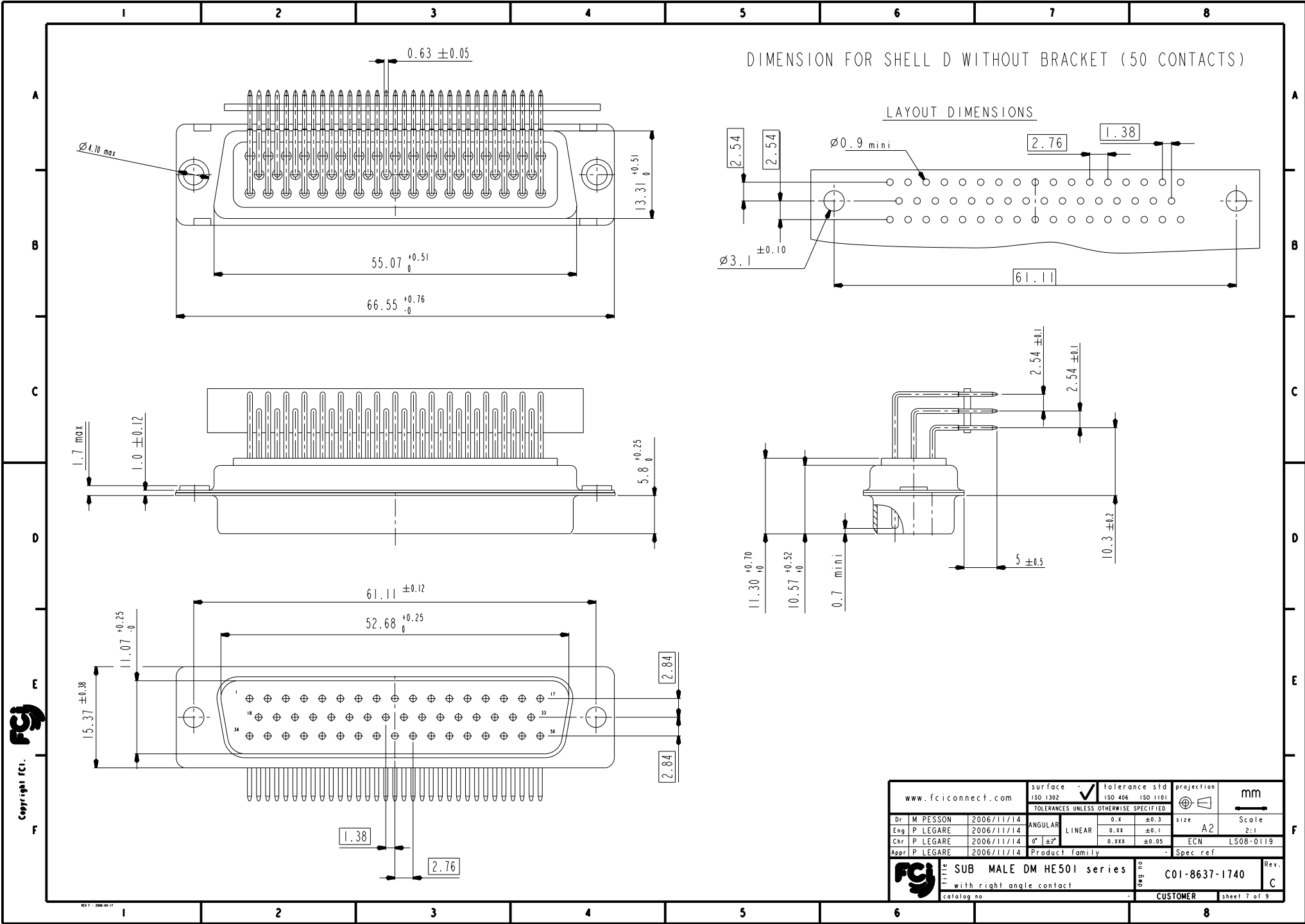

DIMENSION FOR SHELL D WITHOUT BRACKET (50 CONTACTS)

LAYOUT DIMENSIONS

Copyright fci. **fci**

www.fciconnect.com		surface - ISO 1302	tolerance std ISO 406 ISO 1101	projection mm
		TOLERANCES UNLESS OTHERWISE SPECIFIED		
Dr	M PESSON	2006/11/14	ANGULAR	size A2
Eng	P LEGARE	2006/11/14	LINEAR	Scale 2:1
Chr	P LEGARE	2006/11/14	0.xx ± 0.1	ECN LS08-0119
Appr	P LEGARE	2006/11/14	0.xxx ± 0.05	Spec ref
Product family				
fci SUB MALE DM HE501 series		ang no	C01-8637-1740	
with right angle contact		Rev.	C	
catalog no		CUSTOMER		sheet 7 of 9

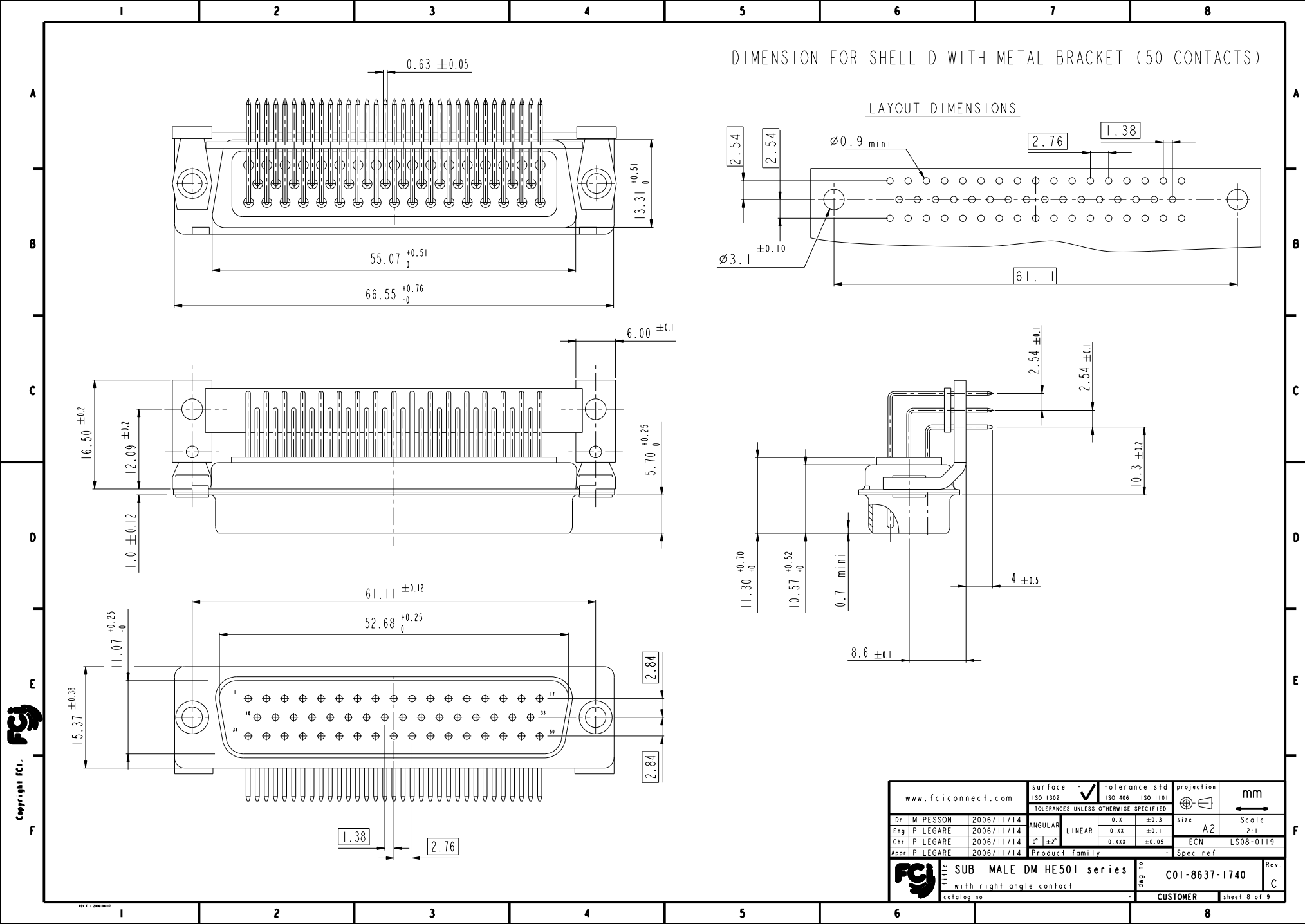

DIMENSION FOR SHELL D WITH METAL BRACKET (50 CONTACTS)

LAYOUT DIMENSIONS

Copyright fci. **fci**

www.fciconnect.com		surface - ISO 1302	tolerance std ISO 406 ISO 1101	projection mm
		TOLERANCES UNLESS OTHERWISE SPECIFIED		
Dr M PESSON	2006/11/14	ANGULAR	0.X ±0.3	size A2 Scale 2:1
Eng P LEGARE	2006/11/14	LINEAR	0.XX ±0.1	ECN LS08-0119
Chr P LEGARE	2006/11/14	0° ±2°	0.XXX ±0.05	Spec ref
Appr P LEGARE	2006/11/14	Product family		
fci SUB MALE DM HE501 series		ang no	C01-8637-1740	
with right angle contact		Rev.	C	
catalog no		CUSTOMER	sheet 8 of 9	

DIMENSIONS FOR SHELL SIZE D WITH PLASTIC BRACKET (50 CONTACTS)

LAYOUT DIMENSIONS

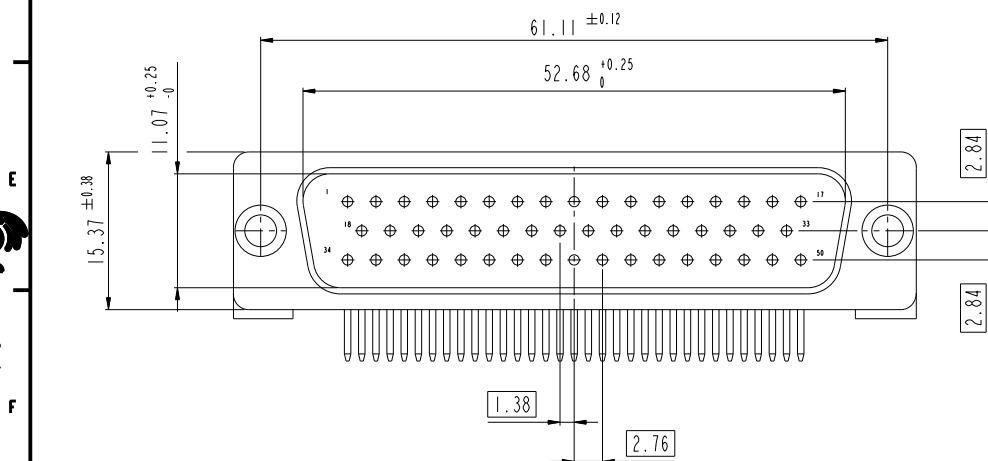
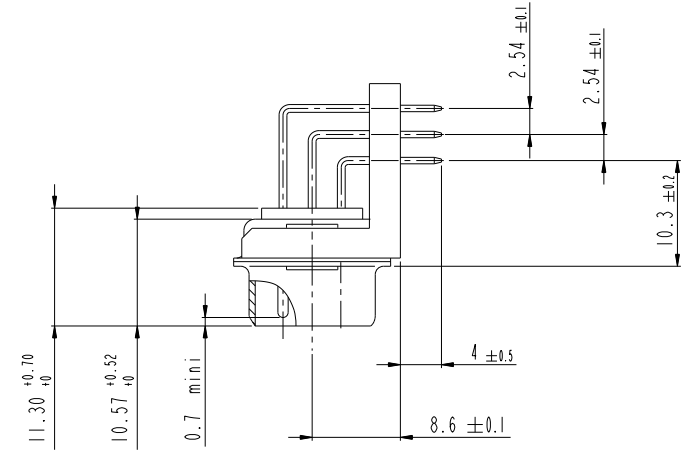
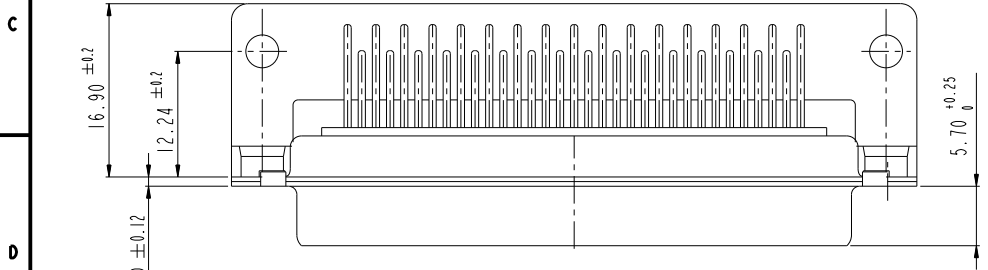
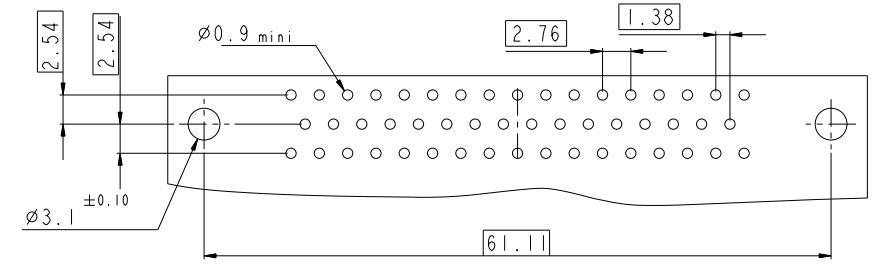
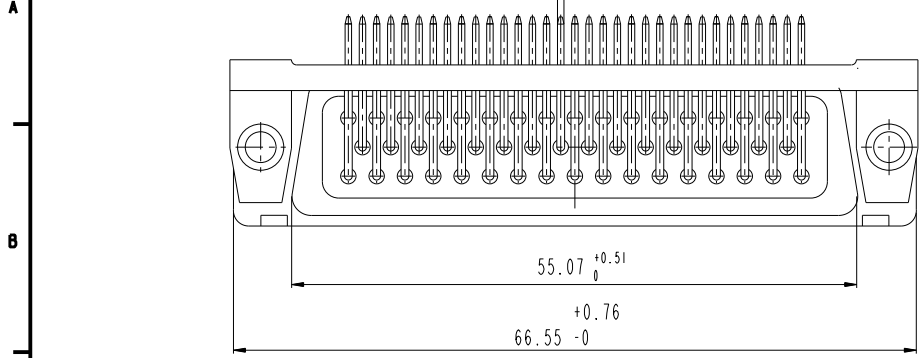

www.fciconnect.com		surface - ISO 1302	tolerance std ISO 406 ISO 1101	projection mm
		TOLERANCES UNLESS OTHERWISE SPECIFIED		
Dr M PESSON	2006/11/14	ANGULAR	0.X ± 0.3	size A2 Scale 2:1
Eng P LEGARE	2006/11/14	LINEAR	0.XX ± 0.1	ECN LS08-0119
Chr P LEGARE	2006/11/14	0° ± 2°	0.XXX ± 0.05	Product family - Spec ref
Appr P LEGARE	2006/11/14			
SUB MALE DM HE501 series with right angle contact catalog no		ang no C01-8637-1740	Rev. C	CUSTOMER sheet 9 of 9

Copyright FCI