

TPS54160EVM-230

Contents

1	Introduction	2
1.1	Background	2
2	Connector Description.....	2
2.1	Input/Output Connector Descriptions.....	2
3	Performance Specifications	3
3.1	Top Converter Specification	3
3.2	Bottom Converter Specification	4
4	Test Results	6
5	Board Layout.....	11
5.1	Layout.....	11
6	Schematic and Bill of Materials.....	17
6.1	Schematic	17
6.2	Bill of Materials	18

List of Figures

1	Synchronization to an External Clock	5
2	Top Converter Efficiency.....	6
3	Bottom Converter Efficiency	6
4	Top Converter Transient Response, 0.5A to 1.5A step, Vin=42V.....	6
5	Bottom Converter Transient Response, 0.5A to 1.5A step, Vin=48V.....	7
6	Top Converter Output Voltage Ripple, Vin=42V, Iout=1.5A.....	7
7	Bottom Converter Output Voltage Ripple, Vin=60.0V, Iout=1.5A	7
8	Top Converter Input Voltage Ripple, Vin=42.0V, Iout=1.5A	8
9	Bottom Converter Input Voltage Ripple, Vin=48.0V, Iout=1.5A.....	8
10	Top Converter Start-up relative to Vin, Vin=42V, Iout=1.5A	8
11	Top Converter UVLO relative to Vin, Iout=1.5A	9
12	Bottom Converter Start-up relative to Vin, Vin=60.0V, Iout=1.5A	9
13	Bottom Converter Start-up relative to EN, Vin=60.0V, Iout=1.5A	9
14	Bottom Converter Loop Response, Vin=36V, Iout=1.0A.....	10
15	Top Converter Loop Response, Vin=42V, Iout=1.0A.....	10
16	Assembly Layer.....	12
17	Top Layer Routing	13
18	Layer 2 Routing.....	14
19	Layer 3 Routing.....	15
20	Bottom Layer Routing.....	16
21	TPS54160EVM-230 Schematic	17

List of Tables

1	Top Converter Specifications.....	4
2	Bottom Converter Specifications.....	4
3	TPS54160EVM-230 Bill of Materials – Top Converter	18
4	TPS54160EVM-230 Bill of Materials – Bottom Converter	18

1 Introduction

The TPS54160EVM-230 evaluation module (EVM) helps designers evaluate the operation and performance of the TPS54160 DC/DC converter. This converter is a wide input voltage (3.5 - 60V), 2.5MHz, non-synchronous, externally compensated, step down converter capable of 1.5A of output current.

1.1 Background

The TPS54160EVM-230 provides two independent DC/DC converters based on the TPS54160. The converter at the top of the board (top converter) is designed to operate from a nominal 42VDC $\pm 25\%$ input voltage source. This input voltage range is typical for input supplies derived from rectified 24VAC sources. The top converter provides a 5.0V output and up to 1.5A of output current. The top converter highlights a small solution size by using 0402 components with the minimum number of parts needed to provide a fully functional DC/DC converter complete with a programmed enable/disable voltage and soft start features.

The converter at the bottom of the board (bottom converter) is designed to operate from 6.0V to 60V, the maximum recommended input voltage the TPS54160. The bottom converter provides a 3.3V output with up to 1.5A of output current. The bottom converter has additional component footprints that can be used by the designer to implement a variety of TPS54160 solutions.

2 Connector Description

This chapter describes the jumpers and connectors on the EVM as well as how to properly connect, setup, and use the TPS54160EVM-230.

2.1 Input/Output Connector Descriptions

2.1.1 J1 – VIN Top Converter

This is the positive input supply voltage to the top converter. The leads to the input supply should be twisted and kept as short as possible to minimize EMI transmission. Additional bulk capacitance should be added between J1 and J2 if the supply leads are greater than six inches. An additional 47 μ F or greater capacitor improves the transient response of the TPS54160 and helps to reduce ringing on the input when long supply wires are used.

2.1.2 J2 – GND Top Converter

This is the return connection for the input power supply of the top converter.

2.1.3 J3 – VOUT Top Converter

This is the positive connection from the output of the top converter. Connect this pin to the positive input of the load.

2.1.4 J4 – VOUT Top Converter

This is the return connection for the output of the top converter.

2.1.5 J5 – VIN Bottom Converter

This is the positive input supply voltage to the bottom converter. The leads to the input supply should be twisted and kept as short as possible to minimize EMI transmission. Additional bulk capacitance should be added between J5 and J6 if the supply leads are greater than six inches. An additional 47 μ F or greater capacitor improves the transient response of the TPS54160 and helps to reduce ringing on the input when long supply wires are used.

2.1.6 J6 – GND Bottom Converter

This is the return connection for the input power supply of the bottom converter.

2.1.7 J7 – ENABLE Bottom Converter

Pin 1 of this connector is tied to the EN pin of the bottom converter. Pin 2 of this connector is tied to the ground plane of the bottom converter. Shorting pin 1 to 2 will disable the converter. Leaving pin 1 and 2 open enables the bottom converter.

2.1.8 J8 – TRACK Bottom Converter

Pin 1 of this connector is tied to the SS pin of the bottom converter. Pin 2 of this connector is tied to the ground plane of the bottom converter. Shorting pin 1 to 2 will disable the converter. Leaving pin 1 and 2 open enables the bottom converter.

2.1.9 J9 – CLK Bottom Converter

Pin 1 of this connector is tied to the RT/CLK pin of the bottom converter. Pin 2 of this connector is tied to the ground plane of the bottom converter.

2.1.10 J10 – VOUT Bottom Converter

This is the positive connection from the output of the bottom converter. Connect this pin to the positive input of the load.

2.1.11 J11 – GND

This is the return connection for the output of the bottom converter.

2.1.12 J12 – PG Top Converter

Pin 1 of this connector is tied to the PWRGD output pin of the top converter. Pin 2 of this connector is tied to the ground plane of the top converter. R4 is pull up resistor for the PG pin and is connected to the output voltage. The maximum voltage of the PWRGD pin is 6V. If the output voltage of the converter is set to any value higher than 6.0V, then R4 must be removed from the board to avoid damaging the TPS54160.

2.1.13 J13 – PG Bottom Converter

Pin 1 of this connector is tied to the PWRGD pin of the bottom converter. Pin 2 of this connector is tied to the ground plane of the bottom converter. R12 is pull up resistor for the PG pin and is connected to the output voltage. The maximum voltage of the PWRGD pin is 6V. If the output voltage of the converter is set to any value higher than 6.0V, then R12 must be removed from the board to avoid damaging the TPS54160.

3 Performance Specifications

3.1 Top Converter Specification

[Table 1](#) provides a summary of the top converters specifications. The top converter is designed and tested for $V_{IN} = 31.5V$ to $52.5V$. Operation at other input voltages is possible but some performance specifications will vary compared to those shown in [Table 2](#). The ambient temperature is $25^{\circ}C$ for all measurements, unless otherwise noted.

Table 1. Top Converter Specifications

SPECIFICATION	TEST CONDITIONS	MIN	TYP	MAX	UNIT
VIN input voltage range		31.5	42	52.5	V
Output voltage			5.0		V
Output current range		0		1.5	A
			1		%/V
Load regulation	Vin = 42 V		0.13		%/A
Load transient response			225		mV
			1.0		ms
Loop bandwidth			29.8		kHz
Phase margin			43		°
Output voltage ripple	Vin = 42 V, Iout = 1.5 V		10		mVpp
Operating frequency			750		kHz
Maximum efficiency	Vin = 42 V, Iout = 800 mA		81.5%		
Converter enable voltage	Vin rising, Io = 1 A		25.8		V
Converter disable voltage	Vin falling, Io = 1 A		25.5		V
Output rise time			32		ms

3.1.1 Modifications of the Top Converter

The top converter is meant to show a small solution size so most of the parts have been selected for their small size. This makes modifications to the top converter difficult since many components are 0402 size. Additionally, to reduce size, there are no additional connectors or jumpers to connect control signals to external circuits. The bottom converter was designed to be more adjustable and accommodate off board signals and parts that are easier to solder. The bottom converter should be used to evaluate circuit modifications.

3.2 Bottom Converter Specification

Table 1 provides a summary of the top converters specifications. The bottom converter is designed and tested for VIN = 6.0V to 60V. Operation at other input voltages is possible, but some performance specifications will vary compared to those shown in Table 2. The ambient temperature is 25°C for all measurements, unless otherwise noted.

Table 2. Bottom Converter Specifications

SPECIFICATION	TEST CONDITIONS	MIN	TYP	MAX	UNIT
VIN input voltage range		6		60	V
Output voltage			3.3		V
Output current range		0		1.5	A
Line regulation	Iout = 1.5 A, Vin = 6 V to 60 V			0.1	%/V
Load regulation			0.11		%/A
Load transient response			120		mV
			2.0		ms
Loop bandwidth			18.5		kHz
Phase margin			72		°
Output voltage ripple			40		mVpp
Operating frequency			415		kHz
Maximum efficiency	Vin = 5 V, Iout = 200 mA		94.60%		
Output rise time			32		ms

3.2.1 Modifications of the Bottom Converter

The bottom converter provides several features that allow custom TPS54160 designs to be evaluated. Many of the control signals are routed to external connectors for easy access. Additionally, the board uses 0603 or larger components and multiple component footprints to ease soldering and assembly of custom designs.

3.2.2 Output Voltage Set Point

To change the output voltage of the EVM, it is necessary to change the value of resistor R14. The value of R14 can be calculated using Equation 1. The converter should be re-compensated if the output voltage is altered from the factory default

$$R14 = R15 \times \left(\frac{V_{out}}{0.8} - 1 \right) \quad (1)$$

The PWRGD pin of the TPS54160 is pulled up to the output voltage by R4 on the top converter and R12 on the bottom converter. The absolute maximum voltage rating of the PWRGD pin is 6.0V. If the output voltage of either converter is modified to be above 6.0V, then the corresponding pull up resistor should be removed so that the absolute maximum rating of the IC is not exceeded.

3.2.3 External Clock Synchronization

The EVM supports connection of an external oscillator for the TPS54160 to synchronize too. A zero ohm resistor should be installed for R17 and a 10pF capacitor installed for C18. Figure 1 shows the connections and components to synchronize to an external clock source.

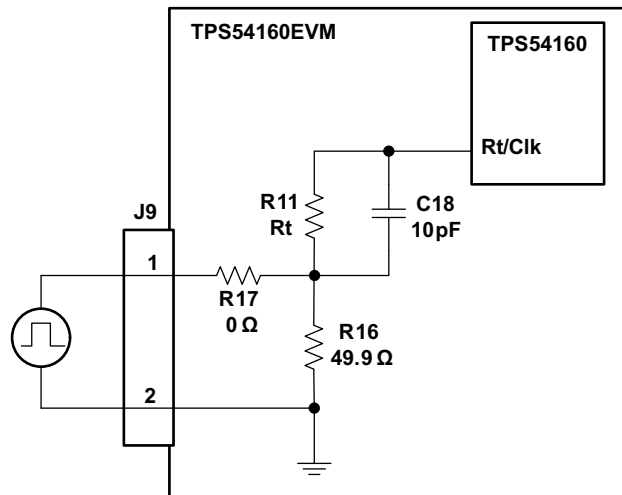

Figure 1. Synchronization to an External Clock

3.2.4 Programmable Under Voltage Lock Out and Enable

The Under Voltage Lock-out (UVLO) and Enable voltages of the TPS54160 have programmable values as shown in the datasheet. The UVLO and Enable levels are programmed using R8 and R9 on the EVM. See the TPS54160 data sheet for how to select the value of these resistors. Capacitor C19 can be installed to add a delay or noise filtering on the EN pin.

4 Test Results

This chapter provides typical performance waveforms for the TPS54160EVM-279 board.

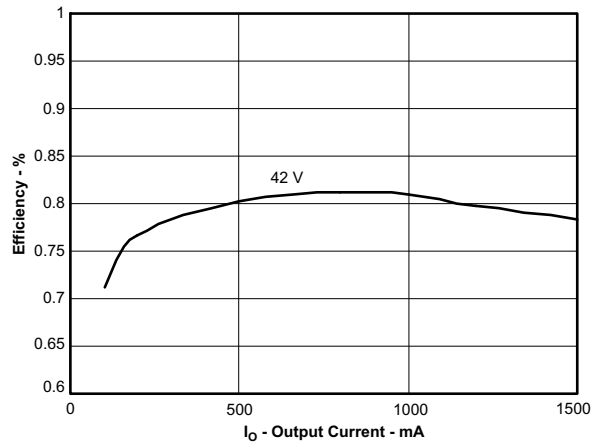

Figure 2. Top Converter Efficiency

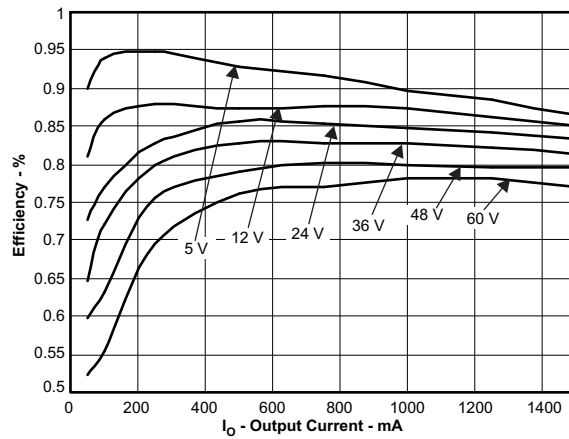

Figure 3. Bottom Converter Efficiency

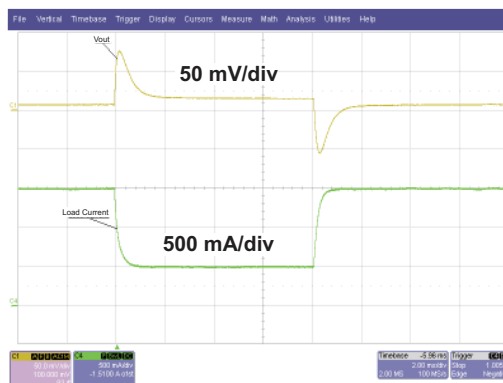

Figure 4. Top Converter Transient Response, 0.5A to 1.5A step, Vin=42V

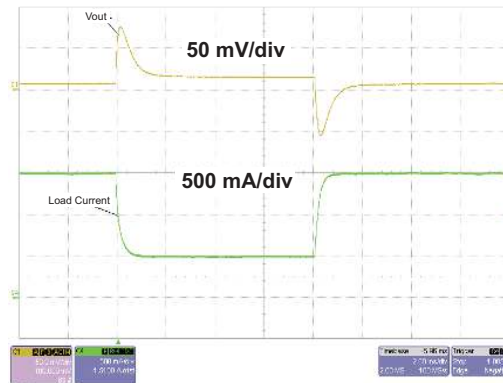

Figure 5. Bottom Converter Transient Response, 0.5A to 1.5A step, Vin=48V

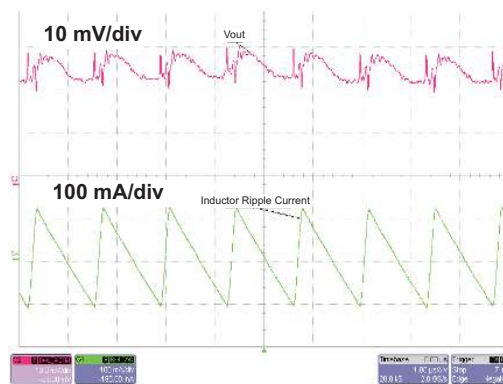

Figure 6. Top Converter Output Voltage Ripple, Vin=42V, Iout=1.5A

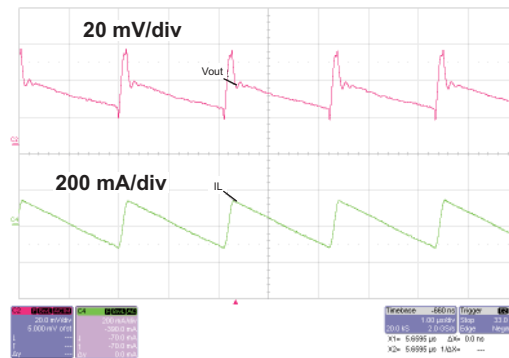

Figure 7. Bottom Converter Output Voltage Ripple, Vin=60.0V, Iout=1.5A

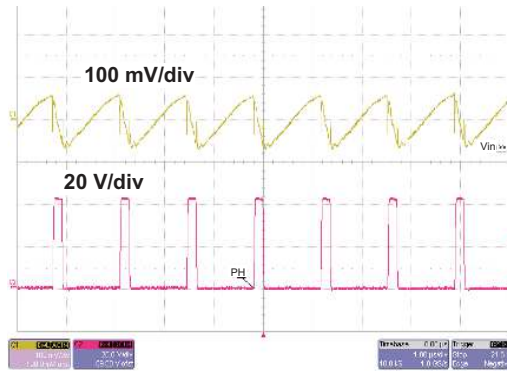

Figure 8. Top Converter Input Voltage Ripple, $V_{in}=42.0V$, $I_{out}=1.5A$

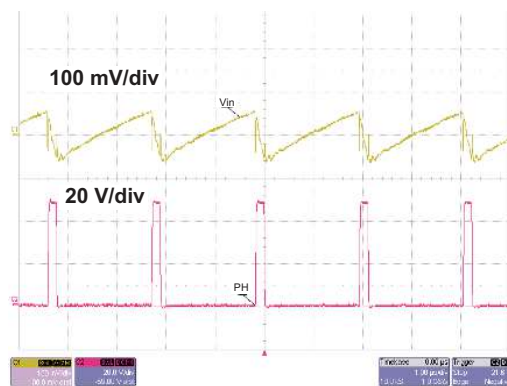

Figure 9. Bottom Converter Input Voltage Ripple, $V_{in}=48.0V$, $I_{out}=1.5A$

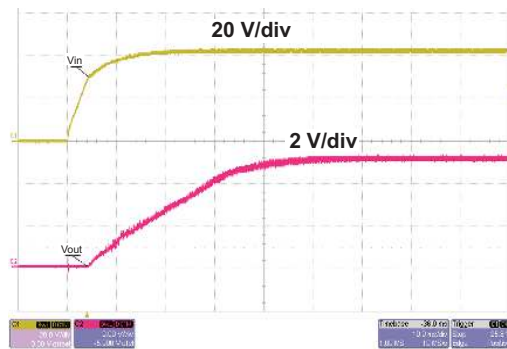

Figure 10. Top Converter Start-up relative to V_{in} , $V_{in}=42V$, $I_{out}=1.5A$

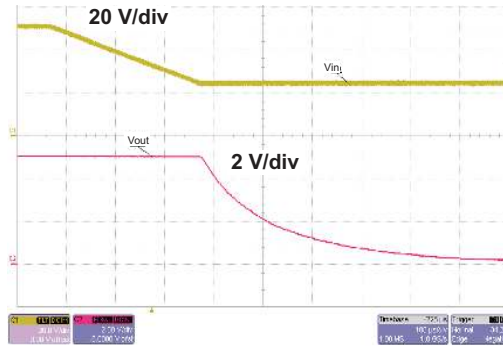

Figure 11. Top Converter UVLO relative to V_{in} , $I_{out}=1.5A$

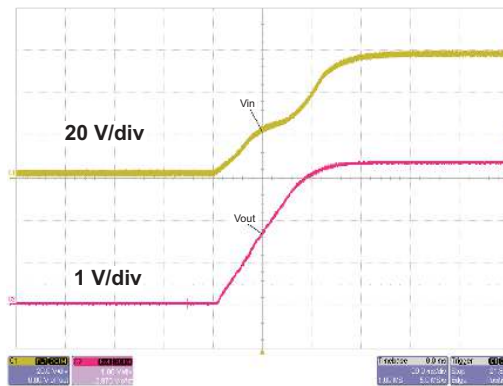

Figure 12. Bottom Converter Start-up relative to V_{in} , $V_{in}=60.0V$, $I_{out}=1.5A$

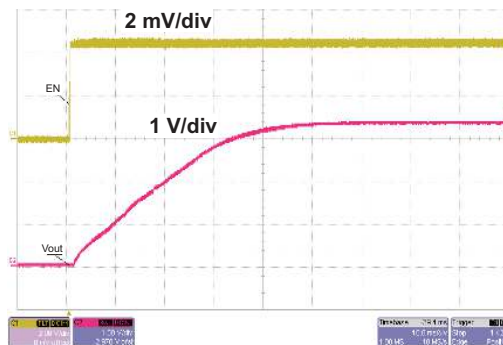

Figure 13. Bottom Converter Start-up relative to EN, $V_{in}=60.0V$, $I_{out}=1.5A$

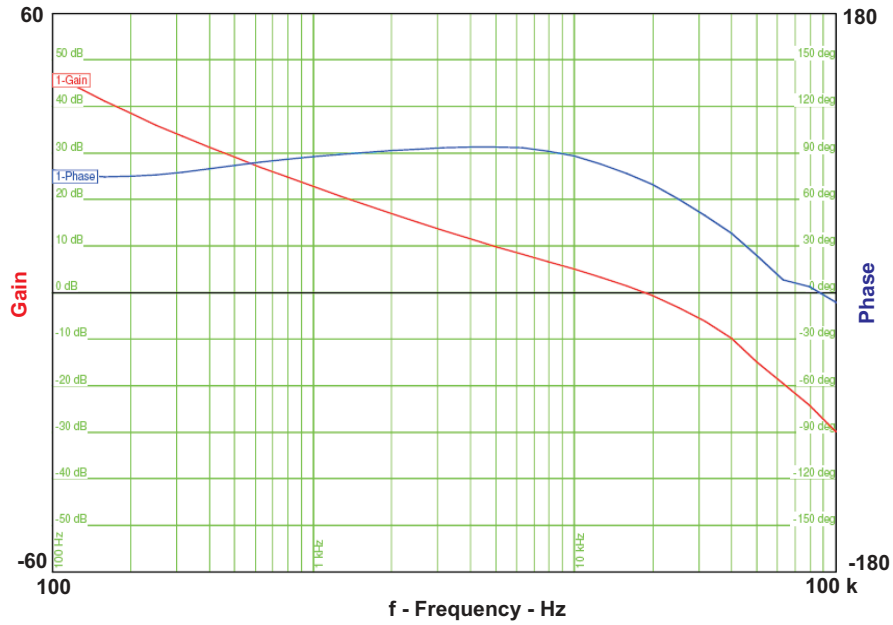

Figure 14. Bottom Converter Loop Response, Vin=36V, Iout=1.0A

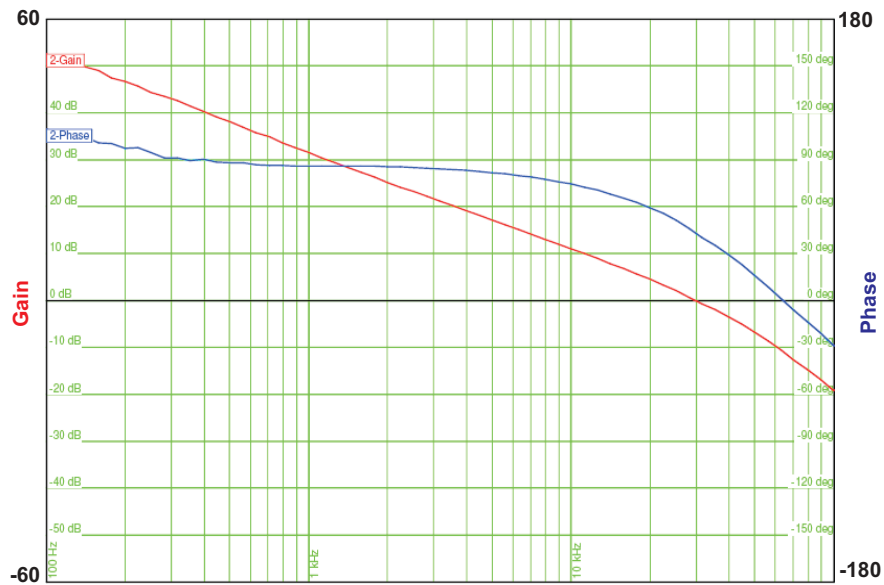

Figure 15. Top Converter Loop Response, Vin=42V, Iout=1.0A

5 Board Layout

This chapter provides the TPS54160EVM-230 board layout and illustrations.

5.1 Layout

Figure 16 through Figure 20 show the layout for each layer of the TPS54160 EVM. The top and bottom layers of the board are 2-oz. copper and the internal layers are 1-oz. copper. The top layer is predominantly used to route the high current traces of the input and output voltages. Some noise sensitive traces, such as the feedback trace, have been routed on the bottom layer so that they are shielded by the large ground plane on the bottom layer. The two inner layers do not have any traces routed on them but do provide additional heat sinking for the ICs.

Board layout is critical for all high frequency switch mode power supplies. The nodes with high switching frequencies and currents are kept as short as possible to minimize trace inductance. Careful attention has been given to the routing of high frequency current loops and a single point grounding scheme is used. Refer to the datasheet for specific layout guidelines.

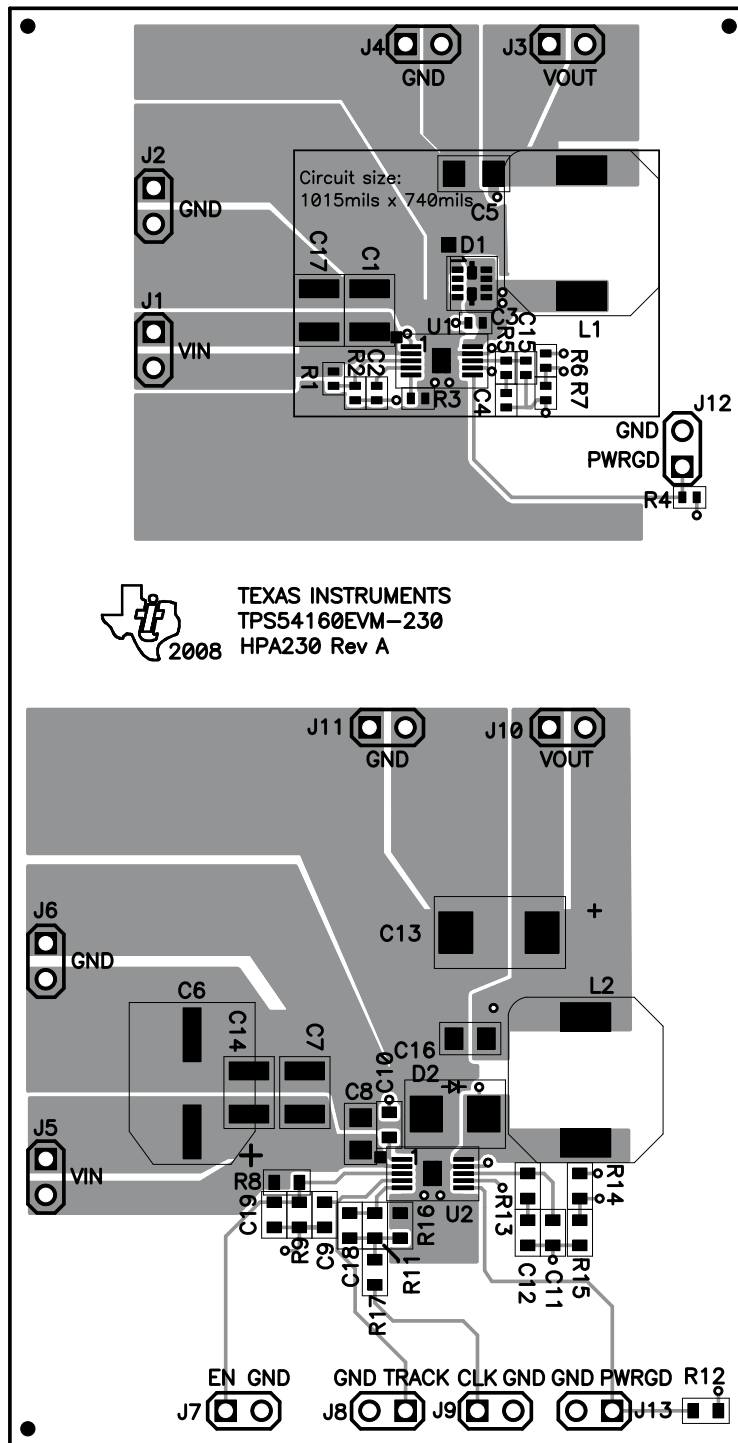

Figure 16. Assembly Layer

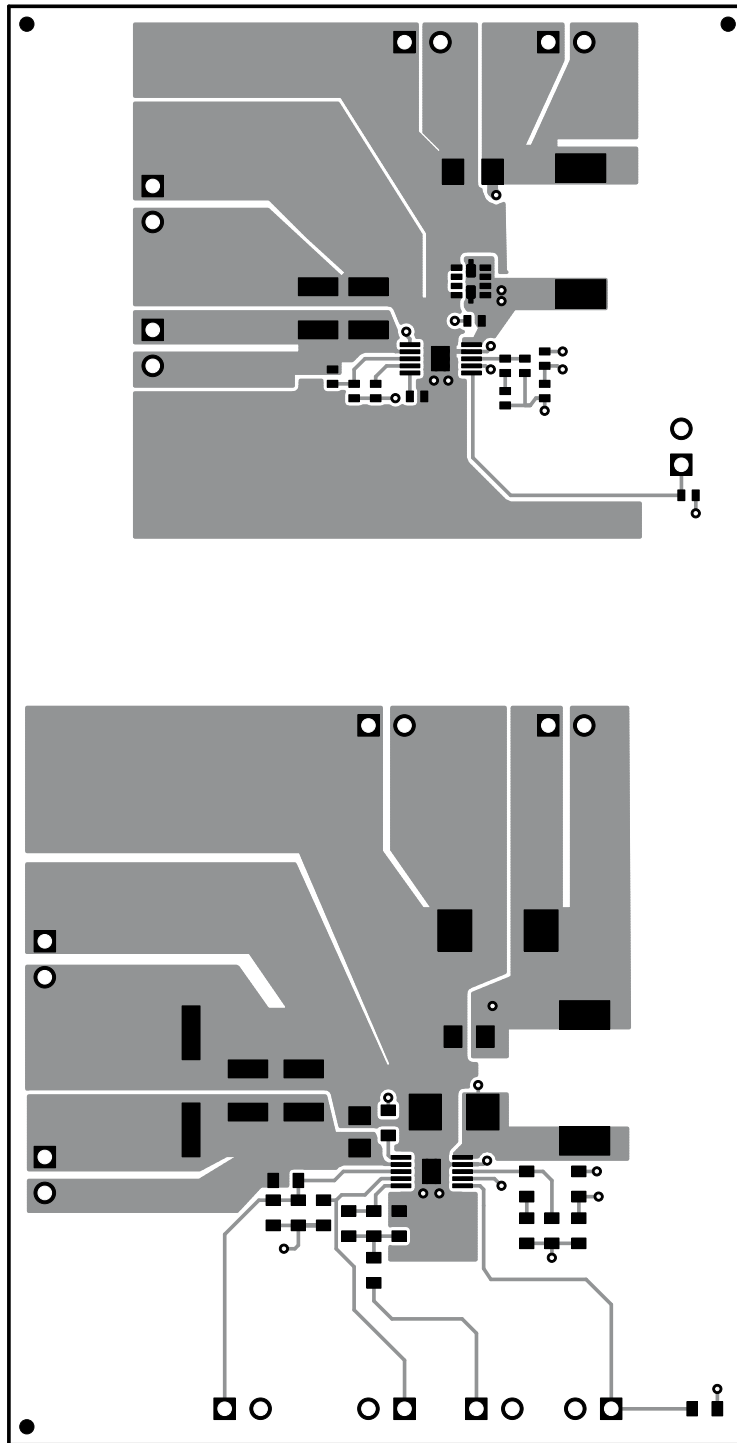

Figure 17. Top Layer Routing

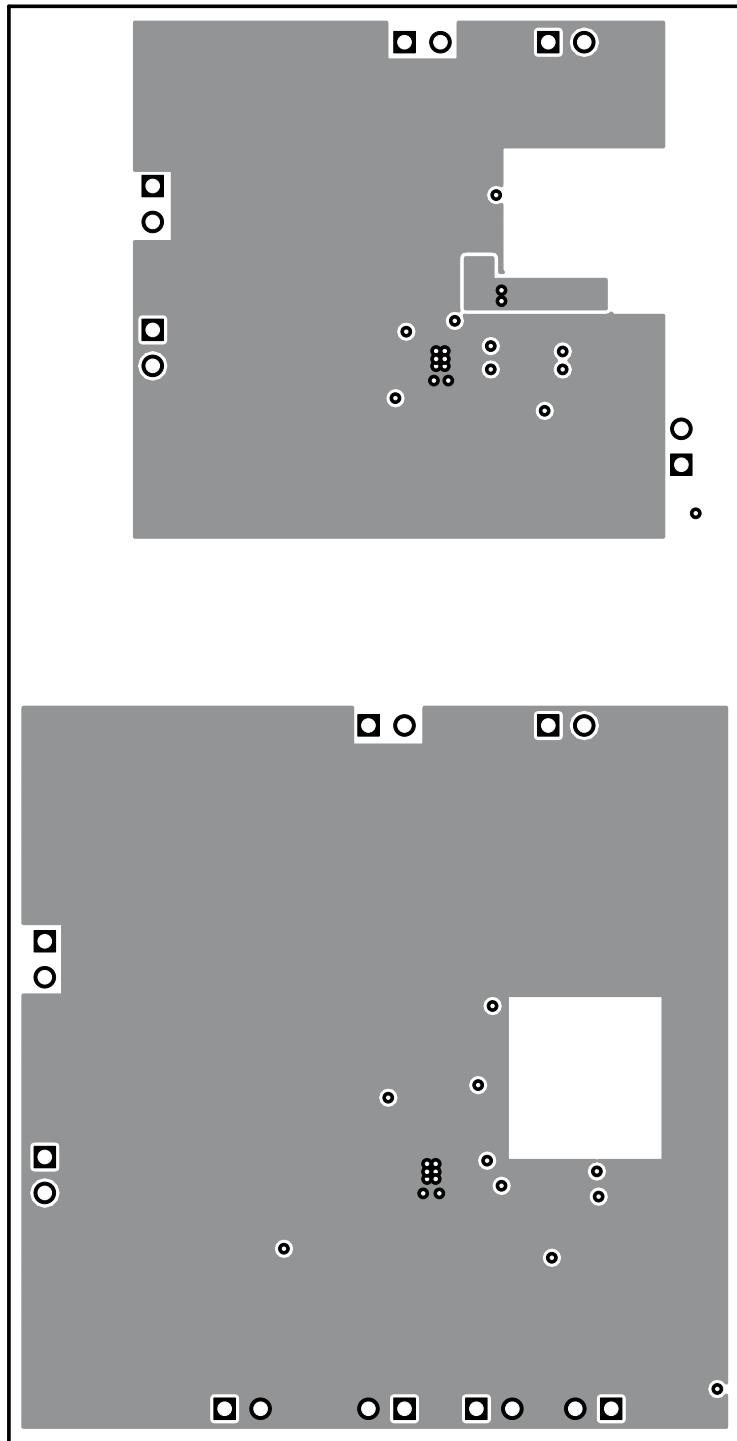

Figure 18. Layer 2 Routing

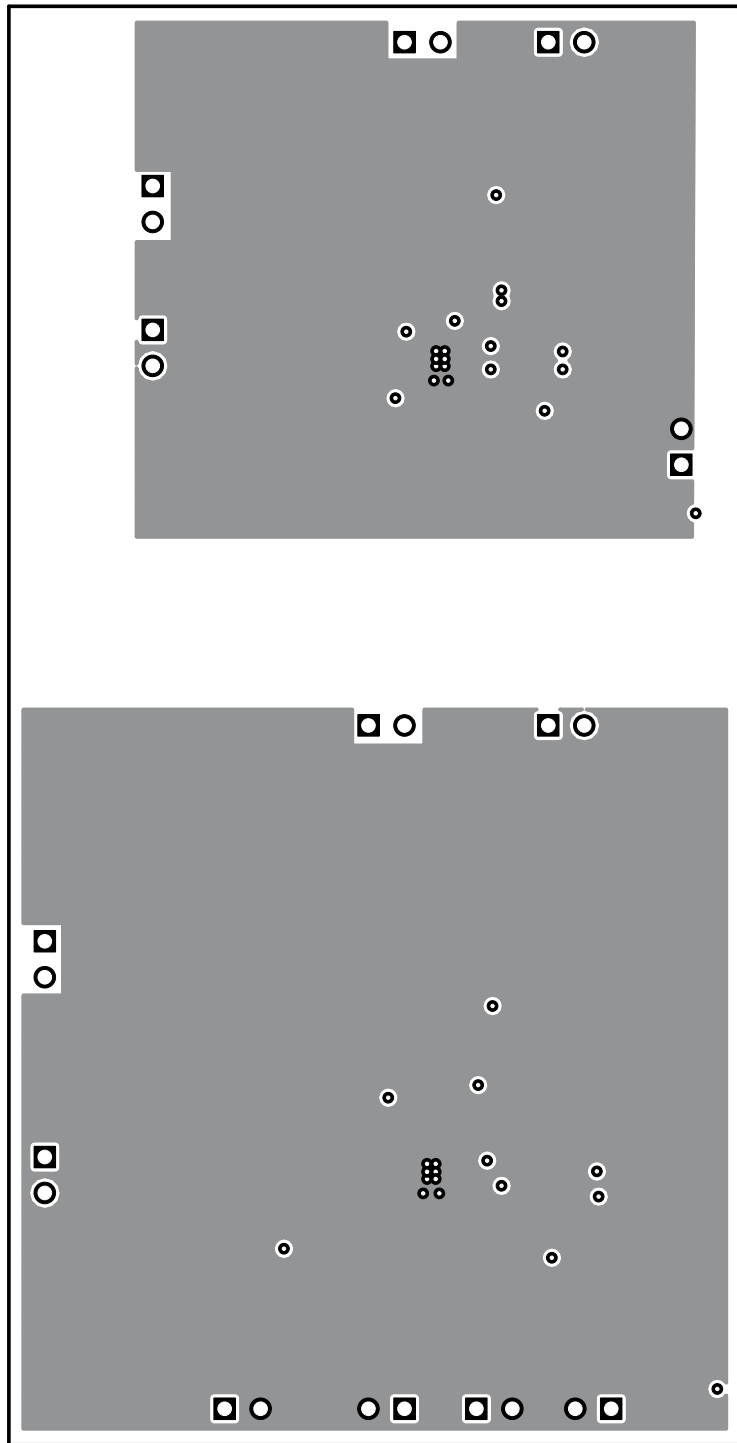

Figure 19. Layer 3 Routing

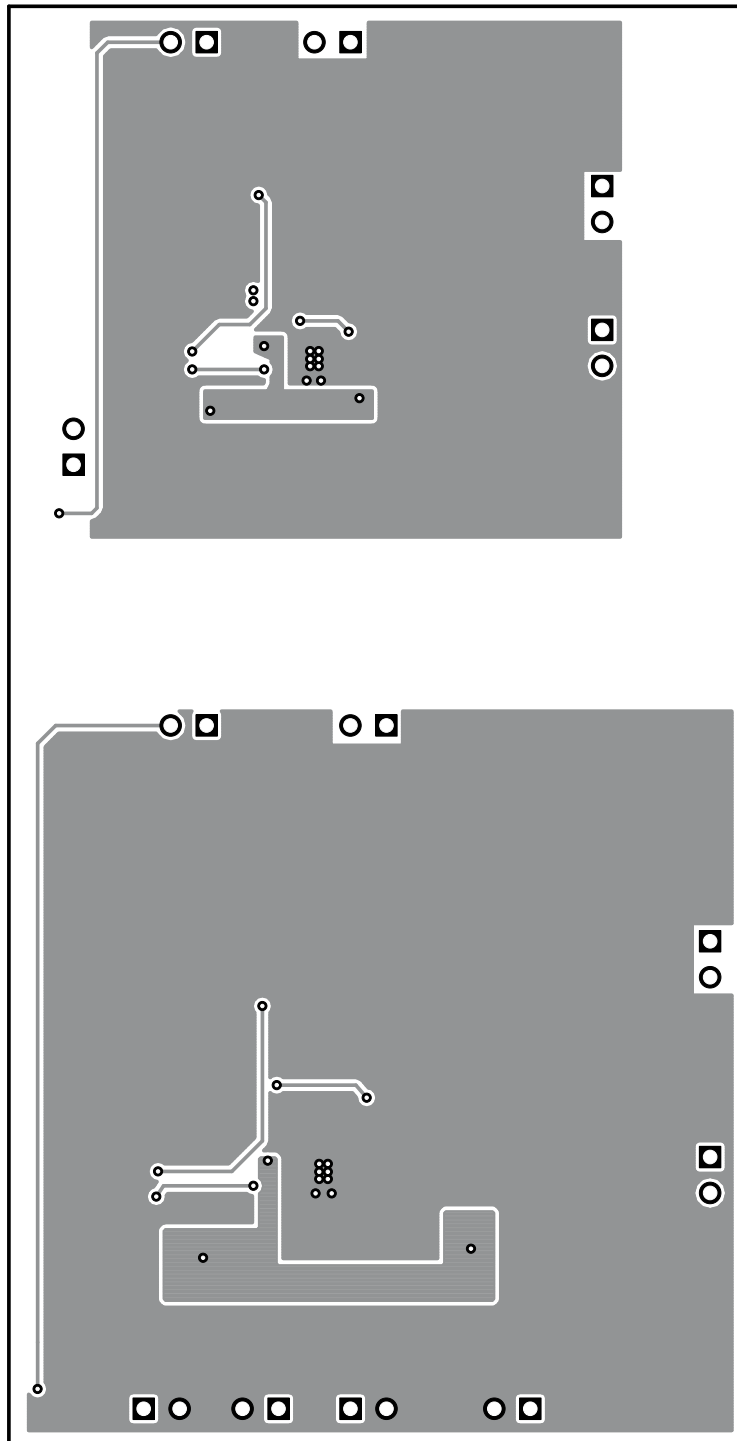

Figure 20. Bottom Layer Routing

6 Schematic and Bill of Materials

This chapter provides the TPS54160EVM-230 schematic and bill of materials

6.1 Schematic

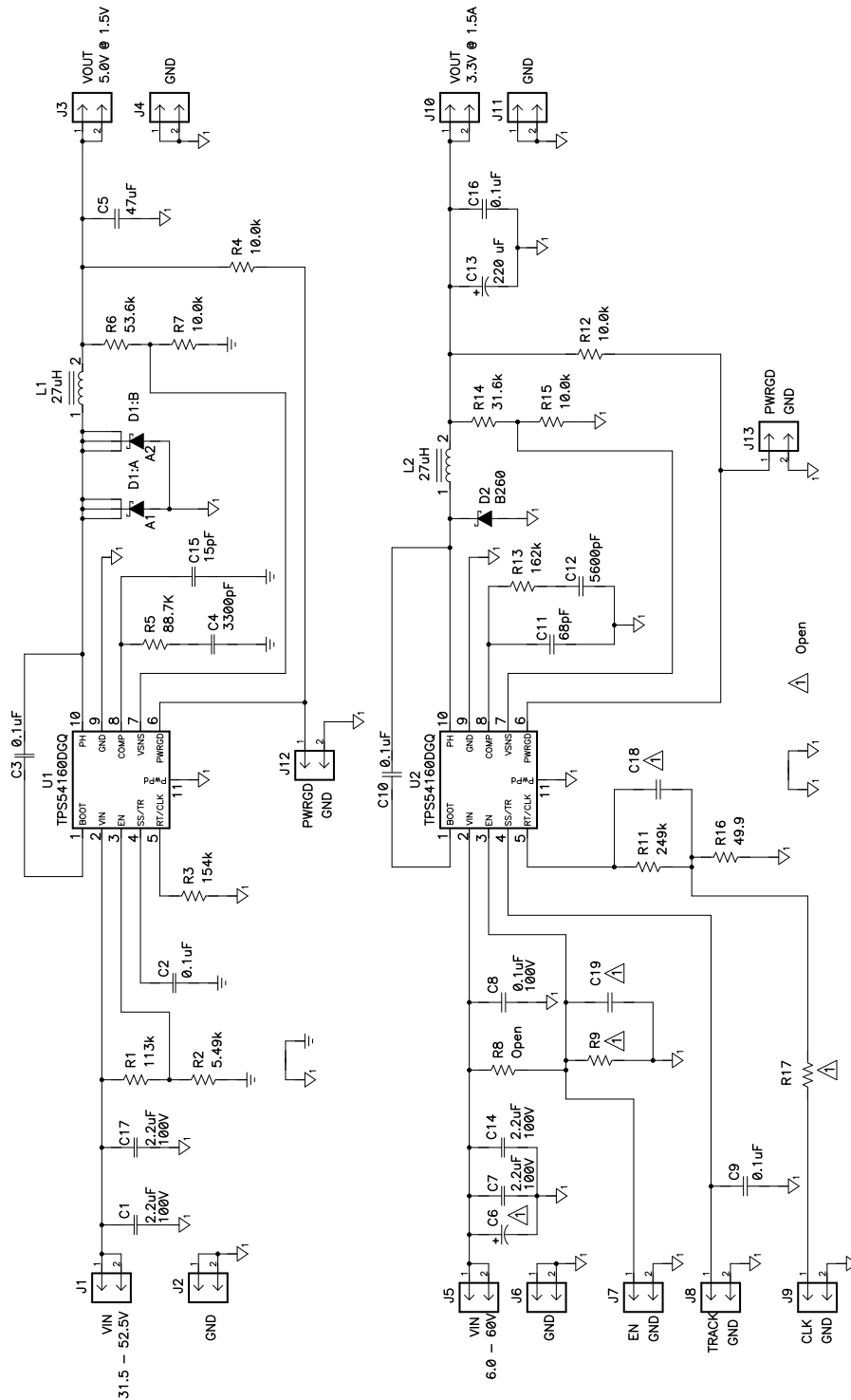

Figure 21. TPS54160EVM-230 Schematic

6.2 Bill of Materials

Table 3. TPS54160EVM-230 Bill of Materials – Top Converter

QTY	RefDes	Value	Description	Size	Part Number	MFR
2	C1, C17	2.2 μ F	Capacitor, Ceramic, 100V, X7R, 10%	1210	Std	Std
1	C15	15 pF	Capacitor, Ceramic, 6.3V, X5R, 20%	0402	Std	Std
1	C2	0.1 μ F	Capacitor, Ceramic, 6.3V, X5R, 20%	0402	Std	Std
1	C3	0.1 μ F	Capacitor, Ceramic, 10V, X5R, 20%	0402	Std	Std
1	C4	3300 pF	Capacitor, Ceramic, 6.3V, X5R, 20%	0402	Std	Std
1	C5	47 μ F	Capacitor, Ceramic, 6.3V, X5R, 20%	1206	Std	Std
1	D1	ZXSDS2M832	Diode, Dual Schottky 60V, 1.65A	MLP832	ZXSDS2M832	Zetex
5	J1-J4, J12	PTC36SAAN	Header, 2-pin, 100mil spacing, (36-pin strip)	0.100 inch x 2	PTC36SAAN	Sullins
1	L1	27 μ H	Inductor, SMT, 2.48A, 89 m Ω	0.402 x 0.394 inch	MSS1038-273ML	Coilcraft
1	R1	113 k Ω	Resistor, Chip, 1/16W, 1%	0402	Std	Std
1	R2	5.49 k Ω	Resistor, Chip, 1/16W, 1%	0402	Std	Std
1	R3	154 k Ω	Resistor, Chip, 1/16W, 1%	0402	Std	Std
2	R4, R7	10.0 k Ω	Resistor, Chip, 1/16W, 1%	0402	Std	Std
1	R5	88.7 k Ω	Resistor, Chip, 1/16W, 1%	0402	Std	Std
1	R6	53.6 k Ω	Resistor, Chip, 1/16W, 1%	0402	Std	Std
1	U1	TPS54160DGQ	IC, DC-DC Converter, 60V, 1.5A	MSOP-10	TPS54160DGQ	TI

Table 4. TPS54160EVM-230 Bill of Materials – Bottom Converter

QTY	RefDes	Value	Description	Size	Part Number	MFR
1	C11	68 pF	Capacitor, Ceramic, 6.3V, X5R, 20%	0603	Std	Std
1	C12	5600 pF	Capacitor, Ceramic, 6.3V, X5R, 20%	0603	Std	Std
1	C13	220 μ F	Capacitor, POSCAP, 220 μ F, 10V, 40milliohm, 20%	7343 (D)	10TPB220M	Sanyo
1	C16	0.1 μ F	Capacitor, Ceramic, 50V, X7R, 10%	0805	Std	Std
0	C18, C19	Open	Capacitor, Ceramic, 6.3V, X5R, 20%	0603	Std	Std
0	C6	Open	Capacitor, Aluminum, SM, 20%, 100V	0.328 x 0.328 inch	EEVFK1xxxxP	Panasonic
2	C7, C14	2.2 μ F	Capacitor, Ceramic, 100V, X7R, 10%	1210	Std	Std
1	C8	0.1 μ F	Capacitor, Ceramic, 100V, X7R, 10%	0805	Std	Std
2	C9, C10	0.1 μ F	Capacitor, Ceramic, 10V, X5R, 20%	0603	Std	Std
1	D2	B260	Diode, Schottky, 60V, 2A	SMB	B260	Vishay
8	J5-J11, J13	PTC36SAAN	Header, 2-pin, 100mil spacing, (36-pin strip)	0.100 inch x 2	PTC36SAAN	Sullins
1	L2	27 μ H	Inductor, SMT, 2.48A, 89 m Ω	0.402 x 0.394 inch	MSS1038-273ML	Coilcraft
1	R11	249 k Ω	Resistor, Chip, 1/16W, 1%	0603	Std	Std

Table 4. TPS54160EVM-230 Bill of Materials – Bottom Converter (continued)

QTY	RefDes	Value	Description	Size	Part Number	MFR
2	R12, R15	10.0 k Ω	Resistor, Chip, 1/16W, 1%	0603	Std	Std
1	R13	162 k Ω	Resistor, Chip, 1/16W, 1%	0603	Std	Std
1	R14	31.6 k Ω	Resistor, Chip, 1/16W, 1%	0603	Std	Std
1	R16	49.9 Ω	Resistor, Chip, 1/16W, 1%	0603	Std	Std
0	R8, R9, R17	Open	Resistor, Chip, 1/16W, 1%	0603	Std	Std
1	U2	TPS54160DGQ	IC, DC-DC Converter, 60V, 1.5A	MSOP-10	TPS54160DGQ	TI

EVALUATION BOARD/KIT IMPORTANT NOTICE

Texas Instruments (TI) provides the enclosed product(s) under the following conditions:

This evaluation board/kit is intended for use for **ENGINEERING DEVELOPMENT, DEMONSTRATION, OR EVALUATION PURPOSES ONLY** and is not considered by TI to be a finished end-product fit for general consumer use. Persons handling the product(s) must have electronics training and observe good engineering practice standards. As such, the goods being provided are not intended to be complete in terms of required design-, marketing-, and/or manufacturing-related protective considerations, including product safety and environmental measures typically found in end products that incorporate such semiconductor components or circuit boards. This evaluation board/kit does not fall within the scope of the European Union directives regarding electromagnetic compatibility, restricted substances (RoHS), recycling (WEEE), FCC, CE or UL, and therefore may not meet the technical requirements of these directives or other related directives.

Should this evaluation board/kit not meet the specifications indicated in the User's Guide, the board/kit may be returned within 30 days from the date of delivery for a full refund. **THE FOREGOING WARRANTY IS THE EXCLUSIVE WARRANTY MADE BY SELLER TO BUYER AND IS IN LIEU OF ALL OTHER WARRANTIES, EXPRESSED, IMPLIED, OR STATUTORY, INCLUDING ANY WARRANTY OF MERCHANTABILITY OR FITNESS FOR ANY PARTICULAR PURPOSE.**

The user assumes all responsibility and liability for proper and safe handling of the goods. Further, the user indemnifies TI from all claims arising from the handling or use of the goods. Due to the open construction of the product, it is the user's responsibility to take any and all appropriate precautions with regard to electrostatic discharge.

EXCEPT TO THE EXTENT OF THE INDEMNITY SET FORTH ABOVE, NEITHER PARTY SHALL BE LIABLE TO THE OTHER FOR ANY INDIRECT, SPECIAL, INCIDENTAL, OR CONSEQUENTIAL DAMAGES.

TI currently deals with a variety of customers for products, and therefore our arrangement with the user **is not exclusive**.

TI assumes **no liability for applications assistance, customer product design, software performance, or infringement of patents or services described herein.**

Please read the User's Guide and, specifically, the Warnings and Restrictions notice in the User's Guide prior to handling the product. This notice contains important safety information about temperatures and voltages. For additional information on TI's environmental and/or safety programs, please contact the TI application engineer or visit www.ti.com/esh.

No license is granted under any patent right or other intellectual property right of TI covering or relating to any machine, process, or combination in which such TI products or services might be or are used.

FCC Warning

This evaluation board/kit is intended for use for **ENGINEERING DEVELOPMENT, DEMONSTRATION, OR EVALUATION PURPOSES ONLY** and is not considered by TI to be a finished end-product fit for general consumer use. It generates, uses, and can radiate radio frequency energy and has not been tested for compliance with the limits of computing devices pursuant to part 15 of FCC rules, which are designed to provide reasonable protection against radio frequency interference. Operation of this equipment in other environments may cause interference with radio communications, in which case the user at his own expense will be required to take whatever measures may be required to correct this interference.

Mailing Address: Texas Instruments, Post Office Box 655303, Dallas, Texas 75265
Copyright © 2008, Texas Instruments Incorporated

EVM WARNINGS AND RESTRICTIONS

It is important to operate this EVM within the input voltage range of 3.5 V to 60 V and the output voltage range of 0.8 V to 60 V.

Exceeding the specified input range may cause unexpected operation and/or irreversible damage to the EVM. If there are questions concerning the input range, please contact a TI field representative prior to connecting the input power.

Applying loads outside of the specified output range may result in unintended operation and/or possible permanent damage to the EVM. Please consult the EVM User's Guide prior to connecting any load to the EVM output. If there is uncertainty as to the load specification, please contact a TI field representative.

During normal operation, some circuit components may have case temperatures greater than 85°C. The EVM is designed to operate properly with certain components above 85°C as long as the input and output ranges are maintained. These components include but are not limited to linear regulators, switching transistors, pass transistors, and current sense resistors. These types of devices can be identified using the EVM schematic located in the EVM User's Guide. When placing measurement probes near these devices during operation, please be aware that these devices may be very warm to the touch.

Mailing Address: Texas Instruments, Post Office Box 655303, Dallas, Texas 75265
Copyright © 2008, Texas Instruments Incorporated

IMPORTANT NOTICE

Texas Instruments Incorporated and its subsidiaries (TI) reserve the right to make corrections, modifications, enhancements, improvements, and other changes to its products and services at any time and to discontinue any product or service without notice. Customers should obtain the latest relevant information before placing orders and should verify that such information is current and complete. All products are sold subject to TI's terms and conditions of sale supplied at the time of order acknowledgment.

TI warrants performance of its hardware products to the specifications applicable at the time of sale in accordance with TI's standard warranty. Testing and other quality control techniques are used to the extent TI deems necessary to support this warranty. Except where mandated by government requirements, testing of all parameters of each product is not necessarily performed.

TI assumes no liability for applications assistance or customer product design. Customers are responsible for their products and applications using TI components. To minimize the risks associated with customer products and applications, customers should provide adequate design and operating safeguards.

TI does not warrant or represent that any license, either express or implied, is granted under any TI patent right, copyright, mask work right, or other TI intellectual property right relating to any combination, machine, or process in which TI products or services are used. Information published by TI regarding third-party products or services does not constitute a license from TI to use such products or services or a warranty or endorsement thereof. Use of such information may require a license from a third party under the patents or other intellectual property of the third party, or a license from TI under the patents or other intellectual property of TI.

Reproduction of TI information in TI data books or data sheets is permissible only if reproduction is without alteration and is accompanied by all associated warranties, conditions, limitations, and notices. Reproduction of this information with alteration is an unfair and deceptive business practice. TI is not responsible or liable for such altered documentation. Information of third parties may be subject to additional restrictions.

Resale of TI products or services with statements different from or beyond the parameters stated by TI for that product or service voids all express and any implied warranties for the associated TI product or service and is an unfair and deceptive business practice. TI is not responsible or liable for any such statements.

TI products are not authorized for use in safety-critical applications (such as life support) where a failure of the TI product would reasonably be expected to cause severe personal injury or death, unless officers of the parties have executed an agreement specifically governing such use. Buyers represent that they have all necessary expertise in the safety and regulatory ramifications of their applications, and acknowledge and agree that they are solely responsible for all legal, regulatory and safety-related requirements concerning their products and any use of TI products in such safety-critical applications, notwithstanding any applications-related information or support that may be provided by TI. Further, Buyers must fully indemnify TI and its representatives against any damages arising out of the use of TI products in such safety-critical applications.

TI products are neither designed nor intended for use in military/aerospace applications or environments unless the TI products are specifically designated by TI as military-grade or "enhanced plastic." Only products designated by TI as military-grade meet military specifications. Buyers acknowledge and agree that any such use of TI products which TI has not designated as military-grade is solely at the Buyer's risk, and that they are solely responsible for compliance with all legal and regulatory requirements in connection with such use.

TI products are neither designed nor intended for use in automotive applications or environments unless the specific TI products are designated by TI as compliant with ISO/TS 16949 requirements. Buyers acknowledge and agree that, if they use any non-designated products in automotive applications, TI will not be responsible for any failure to meet such requirements.

Following are URLs where you can obtain information on other Texas Instruments products and application solutions:

Products

Amplifiers	amplifier.ti.com
Data Converters	dataconverter.ti.com
DSP	dsp.ti.com
Clocks and Timers	www.ti.com/clocks
Interface	interface.ti.com
Logic	logic.ti.com
Power Mgmt	power.ti.com
Microcontrollers	microcontroller.ti.com
RFID	www.ti-rfid.com
RF/IF and ZigBee® Solutions	www.ti.com/lprf

Applications

Audio	www.ti.com/audio
Automotive	www.ti.com/automotive
Broadband	www.ti.com/broadband
Digital Control	www.ti.com/digitalcontrol
Medical	www.ti.com/medical
Military	www.ti.com/military
Optical Networking	www.ti.com/opticalnetwork
Security	www.ti.com/security
Telephony	www.ti.com/telephony
Video & Imaging	www.ti.com/video
Wireless	www.ti.com/wireless

Mailing Address: Texas Instruments, Post Office Box 655303, Dallas, Texas 75265
Copyright © 2008, Texas Instruments Incorporated