

NOTES:

1. GENERAL SPECIFICATIONS: BIVAR MOLDED COMPONENTS SPECIFICATIONS: BV00-E101.
2. MATERIAL: LIGHT PIPE - POLYCARBONATE, 94V-0, CLEAR AND MOUNTING BASE - NYLON 66, 94V-0, BLACK.

REVISIONS			
REV.	DESCRIPTION	DATE	APPROVED
A	Engineering Release	3/19/2019	G.O.

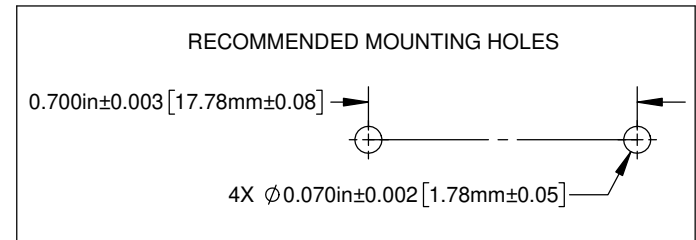
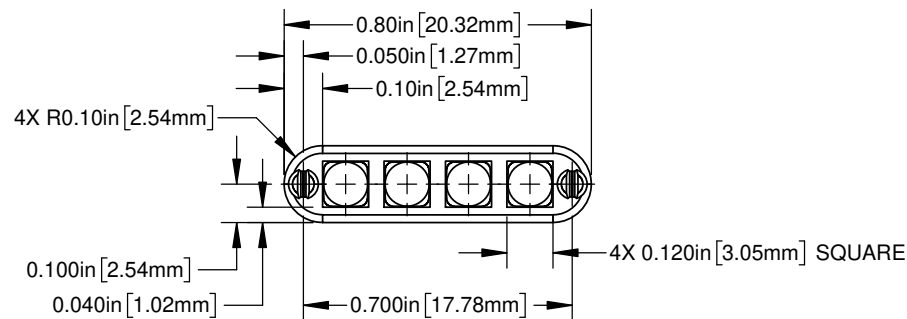
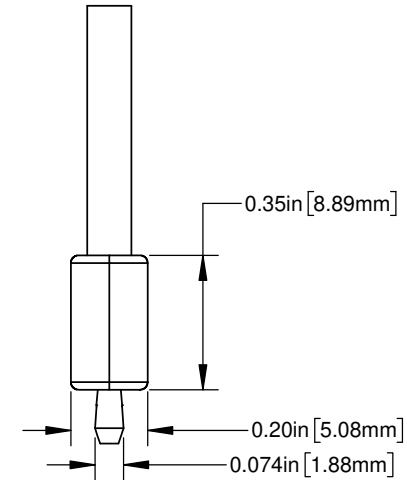
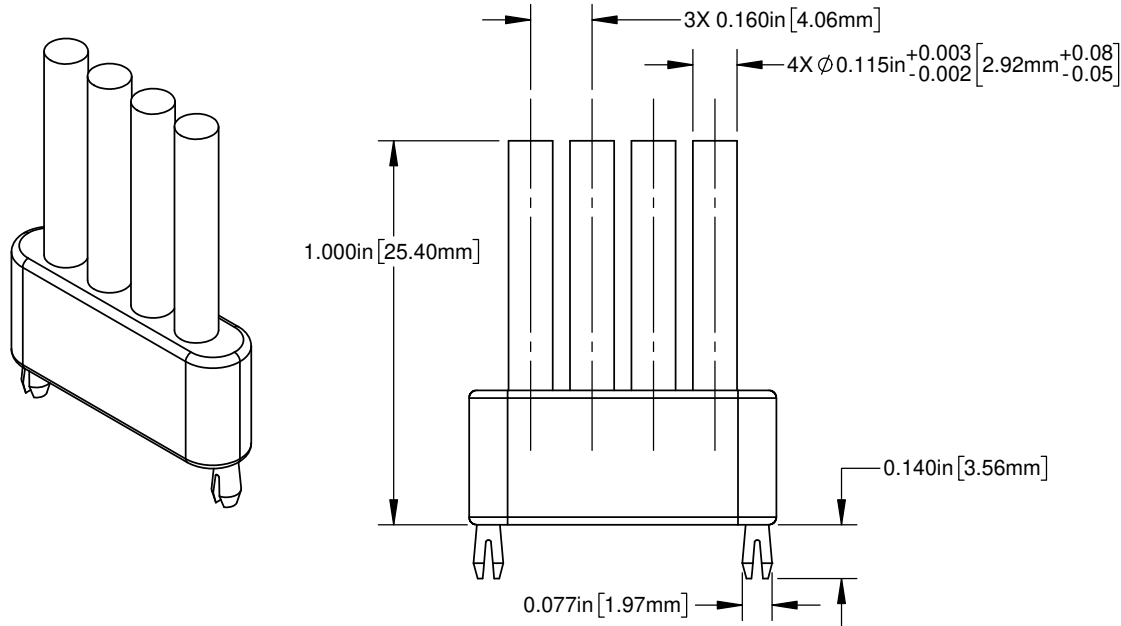

STANDARD TOLERANCE (UNLESS OTHERWISE SPECIFIED)		 4 THOMAS, IRVINE, CA. 92618 TEL: (949) 951-8808 FAX: (949) 951-3974	
DECIMALS	ANGULAR		
.X ± .1	X° ± 1°	TITLE: BLS ARRAY, VERTICAL, 3mm	
.XX ± .01		DESIGNED: K. BARON	DATE: 03/19/19
.XXX ± .005		REVISION: A	PART NO: LPAV3-160-1000F-1-4
		REVISOR: N/A	DATE: N/A
		CHECKED: TD. NGUYEN	DATE: 03/19/19
		CAGE CODE: 32559	SCALE: 2:1
		SHEET # 1 OF 1	
CAD GENERATED DOCUMENT, DO NOT MEASURE DRAWING			