

RX72M Group

Renesas Starter Kit+ for RX72M
User's Manual

RENESAS 32-Bit MCU
RX Family / RX700 Series

All information contained in these materials, including products and product specifications, represents information on the product at the time of publication and is subject to change by Renesas Electronics Corp. without notice. Please review the latest information published by Renesas Electronics Corp. through various means, including the Renesas Electronics Corp. website (<http://www.renesas.com>).

Notice

1. Descriptions of circuits, software and other related information in this document are provided only to illustrate the operation of semiconductor products and application examples. You are fully responsible for the incorporation or any other use of the circuits, software, and information in the design of your product or system. Renesas Electronics disclaims any and all liability for any losses and damages incurred by you or third parties arising from the use of these circuits, software, or information.
2. Renesas Electronics hereby expressly disclaims any warranties against and liability for infringement or any other claims involving patents, copyrights, or other intellectual property rights of third parties, by or arising from the use of Renesas Electronics products or technical information described in this document, including but not limited to, the product data, drawings, charts, programs, algorithms, and application examples.
3. No license, express, implied or otherwise, is granted hereby under any patents, copyrights or other intellectual property rights of Renesas Electronics or others.
4. You shall not alter, modify, copy, or reverse engineer any Renesas Electronics product, whether in whole or in part. Renesas Electronics disclaims any and all liability for any losses or damages incurred by you or third parties arising from such alteration, modification, copying or reverse engineering.
5. Renesas Electronics products are classified according to the following two quality grades: "Standard" and "High Quality". The intended applications for each Renesas Electronics product depends on the product's quality grade, as indicated below.
"Standard": Computers; office equipment; communications equipment; test and measurement equipment; audio and visual equipment; home electronic appliances; machine tools; personal electronic equipment; industrial robots; etc.
"High Quality": Transportation equipment (automobiles, trains, ships, etc.); traffic control (traffic lights); large-scale communication equipment; key financial terminal systems; safety control equipment; etc.
Unless expressly designated as a high reliability product or a product for harsh environments in a Renesas Electronics data sheet or other Renesas Electronics document, Renesas Electronics products are not intended or authorized for use in products or systems that may pose a direct threat to human life or bodily injury (artificial life support devices or systems; surgical implantations; etc.), or may cause serious property damage (space system; undersea repeaters; nuclear power control systems; aircraft control systems; key plant systems; military equipment; etc.). Renesas Electronics disclaims any and all liability for any damages or losses incurred by you or any third parties arising from the use of any Renesas Electronics product that is inconsistent with any Renesas Electronics data sheet, user's manual or other Renesas Electronics document.
6. When using Renesas Electronics products, refer to the latest product information (data sheets, user's manuals, application notes, "General Notes for Handling and Using Semiconductor Devices" in the reliability handbook, etc.), and ensure that usage conditions are within the ranges specified by Renesas Electronics with respect to maximum ratings, operating power supply voltage range, heat dissipation characteristics, installation, etc. Renesas Electronics disclaims any and all liability for any malfunctions, failure or accident arising out of the use of Renesas Electronics products outside of such specified ranges.
7. Although Renesas Electronics endeavors to improve the quality and reliability of Renesas Electronics products, semiconductor products have specific characteristics, such as the occurrence of failure at a certain rate and malfunctions under certain use conditions. Unless designated as a high reliability product or a product for harsh environments in a Renesas Electronics data sheet or other Renesas Electronics document, Renesas Electronics products are not subject to radiation resistance design. You are responsible for implementing safety measures to guard against the possibility of bodily injury, injury or damage caused by fire, and/or danger to the public in the event of a failure or malfunction of Renesas Electronics products, such as safety design for hardware and software, including but not limited to redundancy, fire control and malfunction prevention, appropriate treatment for aging degradation or any other appropriate measures. Because the evaluation of microcomputer software alone is very difficult and impractical, you are responsible for evaluating the safety of the final products or systems manufactured by you.
8. Please contact a Renesas Electronics sales office for details as to environmental matters such as the environmental compatibility of each Renesas Electronics product. You are responsible for carefully and sufficiently investigating applicable laws and regulations that regulate the inclusion or use of controlled substances, including without limitation, the EU RoHS Directive, and using Renesas Electronics products in compliance with all these applicable laws and regulations. Renesas Electronics disclaims any and all liability for damages or losses occurring as a result of your noncompliance with applicable laws and regulations.
9. Renesas Electronics products and technologies shall not be used for or incorporated into any products or systems whose manufacture, use, or sale is prohibited under any applicable domestic or foreign laws or regulations. You shall comply with any applicable export control laws and regulations promulgated and administered by the governments of any countries asserting jurisdiction over the parties or transactions.
10. It is the responsibility of the buyer or distributor of Renesas Electronics products, or any other party who distributes, disposes of, or otherwise sells or transfers the product to a third party, to notify such third party in advance of the contents and conditions set forth in this document.
11. This document shall not be reprinted, reproduced or duplicated in any form, in whole or in part, without prior written consent of Renesas Electronics.
12. Please contact a Renesas Electronics sales office if you have any questions regarding the information contained in this document or Renesas Electronics products.

(Note1) "Renesas Electronics" as used in this document means Renesas Electronics Corporation and also includes its directly or indirectly controlled subsidiaries.

(Note2) "Renesas Electronics product(s)" means any product developed or manufactured by or for Renesas Electronics.

(Rev.4.0-1 November 2017)

Corporate Headquarters

TOYOSU FORESIA, 3-2-24 Toyosu,
Koto-ku, Tokyo 135-0061, Japan

www.renesas.com

Contact information

For further information on a product, technology, the most up-to-date version of a document, or your nearest sales office, please visit:

www.renesas.com/contact/.

Trademarks

Renesas and the Renesas logo are trademarks of Renesas Electronics Corporation. All trademarks and registered trademarks are the property of their respective owners.

General Precautions in the Handling of Microprocessing Unit and Microcontroller Unit Products

The following usage notes are applicable to all Microprocessing unit and Microcontroller unit products from Renesas. For detailed usage notes on the products covered by this document, refer to the relevant sections of the document as well as any technical updates that have been issued for the products.

1. Precaution against Electrostatic Discharge (ESD)

A strong electrical field, when exposed to a CMOS device, can cause destruction of the gate oxide and ultimately degrade the device operation. Steps must be taken to stop the generation of static electricity as much as possible, and quickly dissipate it when it occurs. Environmental control must be adequate. When it is dry, a humidifier should be used. This is recommended to avoid using insulators that can easily build up static electricity. Semiconductor devices must be stored and transported in an anti-static container, static shielding bag or conductive material. All test and measurement tools including work benches and floors must be grounded. The operator must also be grounded using a wrist strap. Semiconductor devices must not be touched with bare hands. Similar precautions must be taken for printed circuit boards with mounted semiconductor devices.

2. Processing at power-on

The state of the product is undefined at the time when power is supplied. The states of internal circuits in the LSI are indeterminate and the states of register settings and pins are undefined at the time when power is supplied. In a finished product where the reset signal is applied to the external reset pin, the states of pins are not guaranteed from the time when power is supplied until the reset process is completed. In a similar way, the states of pins in a product that is reset by an on-chip power-on reset function are not guaranteed from the time when power is supplied until the power reaches the level at which resetting is specified.

3. Input of signal during power-off state

Do not input signals or an I/O pull-up power supply while the device is powered off. The current injection that results from input of such a signal or I/O pull-up power supply may cause malfunction and the abnormal current that passes in the device at this time may cause degradation of internal elements. Follow the guideline for input signal during power-off state as described in your product documentation.

4. Handling of unused pins

Handle unused pins in accordance with the directions given under handling of unused pins in the manual. The input pins of CMOS products are generally in the high-impedance state. In operation with an unused pin in the open-circuit state, extra electromagnetic noise is induced in the vicinity of the LSI, an associated shoot-through current flows internally, and malfunctions occur due to the false recognition of the pin state as an input signal become possible.

5. Clock signals

After applying a reset, only release the reset line after the operating clock signal becomes stable. When switching the clock signal during program execution, wait until the target clock signal is stabilized. When the clock signal is generated with an external resonator or from an external oscillator during a reset, ensure that the reset line is only released after full stabilization of the clock signal. Additionally, when switching to a clock signal produced with an external resonator or by an external oscillator while program execution is in progress, wait until the target clock signal is stable.

6. Voltage application waveform at input pin

Waveform distortion due to input noise or a reflected wave may cause malfunction. If the input of the CMOS device stays in the area between V_{IL} (Max.) and V_{IH} (Min.) due to noise, for example, the device may malfunction. Take care to prevent chattering noise from entering the device when the input level is fixed, and also in the transition period when the input level passes through the area between V_{IL} (Max.) and V_{IH} (Min.).

7. Prohibition of access to reserved addresses

Access to reserved addresses is prohibited. The reserved addresses are provided for possible future expansion of functions. Do not access these addresses as the correct operation of the LSI is not guaranteed.

8. Differences between products

Before changing from one product to another, for example to a product with a different part number, confirm that the change will not lead to problems. The characteristics of a microprocessing unit or microcontroller unit products in the same group but having a different part number might differ in terms of internal memory capacity, layout pattern, and other factors, which can affect the ranges of electrical characteristics, such as characteristic values, operating margins, immunity to noise, and amount of radiated noise. When changing to a product with a different part number, implement a system-evaluation test for the given product.

Disclaimer

By using this Renesas Starter Kit+ (RSK+), the user accepts the following terms:

The RSK+ is not guaranteed to be error free, and the entire risk as to the results and performance of the RSK+ is assumed by the User. The RSK+ is provided by Renesas on an "as is" basis without warranty of any kind whether express or implied, including but not limited to the implied warranties of satisfactory quality, fitness for a particular purpose, title and non-infringement of intellectual property rights with regard to the RSK+. Renesas expressly disclaims all such warranties. Renesas or its affiliates shall in no event be liable for any loss of profit, loss of data, loss of contract, loss of business, damage to reputation or goodwill, any economic loss, any reprogramming or recall costs (whether the foregoing losses are direct or indirect) nor shall Renesas or its affiliates be liable for any other direct or indirect special, incidental or consequential damages arising out of or in relation to the use of this RSK+, even if Renesas or its affiliates have been advised of the possibility of such damages.

Precautions

The following precautions should be observed when operating any RSK+ product:

This Renesas Starter Kit+ is only intended for use in a laboratory environment under ambient temperature and humidity conditions. A safe separation distance should be used between this and any sensitive equipment. Its use outside the laboratory, classroom, study area or similar such area invalidates conformity with the protection requirements of the Electromagnetic Compatibility Directive and could lead to prosecution.

The product generates, uses, and can radiate radio frequency energy and may cause harmful interference to radio communications. However, there is no guarantee that interference will not occur in a particular installation. If this equipment causes harmful interference to radio or television reception, which can be determined by turning the equipment off or on, you are encouraged to try to correct the interference by one or more of the following measures;

- ensure attached cables do not lie across the equipment
- reorient the receiving antenna
- increase the distance between the equipment and the receiver
- connect the equipment into an outlet on a circuit different from that which the receiver is connected
- power down the equipment when not in use
- consult the dealer or an experienced radio/TV technician for help NOTE: It is recommended that wherever possible shielded interface cables are used.

The product is potentially susceptible to certain EMC phenomena. To mitigate against them it is recommended that the following measures be undertaken;

- The user is advised that mobile phones should not be used within 10m of the product when in use.
- The user is advised to take ESD precautions when handling the equipment.

The Renesas Starter Kit does not represent an ideal reference design for an end product and does not fulfil the regulatory standards for an end product.

How to Use This Manual

1. Purpose and Target Readers

This manual is designed to provide the user with an understanding of the CPU Board hardware functionality, and electrical characteristics. It is intended for users designing sample code on the CPU Board platform, using the many different incorporated peripheral devices.

The manual comprises of an overview of the capabilities of the RSK+ product, but does not intend to be a guide to embedded programming or hardware design.

Particular attention should be paid to the precautionary notes when using the manual. These notes occur within the body of the text, at the end of each section, and in the Usage Notes section.

The revision history summarizes the locations of revisions and additions. It does not list all revisions. Refer to the text of the manual for details.

The following documents apply to the RX72M Group. Make sure to refer to the latest versions of these documents. The newest versions of the documents listed may be obtained from the Renesas Electronics Web site.

Document Type	Description	Document Title	Document No.
User's Manual	Describes the technical details of the RSK+ hardware.	Renesas Starter Kit+ for RX72M User's Manual	R20UT4391EG
Tutorial Manual	Provides a guide to setting up RSK+ environment, running sample code and debugging programs.	Renesas Starter Kit+ for RX72M Tutorial Manual	CS+: R20UT4384EG e ² studio: R20UT4387EG
Quick Start Guide	Provides simple instructions to setup the RSK+ and run the first sample.	Renesas Starter Kit+ for RX72M Quick Start Guide	CS+: R20UT4385EG e ² studio: R20UT4388EG
Smart Configurator Tutorial	Provides a guide to code generation and importing into the e ² studio IDE.	Renesas Starter Kit+ for RX72M Smart Configurator Tutorial Manual	CS+: R20UT4386EG e ² studio: R20UT4389EG
Schematics	Full detail circuit schematics of the CPU Board.	Renesas Starter Kit for RX72M Schematics	R20UT4390EG
Hardware Manual	Provides technical details of the RX72M microcontroller.	RX72M Group Hardware Manual	R01UH0804EJ

2. List of Abbreviations and Acronyms

Abbreviation	Full Form
ADC	Analog-to-Digital Converter
BC	Battery Charging
bps	bits per second
CAN	Controller Area Network
CPU	Central Processing Unit
DAC	Digital-to-Analog Converter
DIP	Dual In-line Package
DMA	Direct Memory Access
DMAC	Direct Memory Access Controller
DNF	Do Not Fit
E1 / E2 Lite	Renesas On-chip Debugging Emulator
EEPROM	Electrically Erasable Programmable Read Only Memory
EMC	Electromagnetic Compatibility
ESD	Electrostatic Discharge
GLCDC	Graphic LCD Controller
I2C (IIC)	Philips™ Inter-Integrated Circuit Connection Bus
IRQ	Interrupt Request
LCD	Liquid Crystal Display
LED	Light Emitting Diode
LIN	Local Interconnect Network
MCU	Micro-controller Unit
MTU	Multi-Function Timer Pulse Unit
n/a (NA)	Not Applicable
n/c (NC)	Not Connected
NMI	Non-maskable Interrupt
OTG	On The Go™
PC	Personal Computer
PDC	Parallel Data Capture Unit
PLL	Phase Locked Loop
Pmod™	This is a Digilent Pmod™ Compatible connector. Pmod™ is registered to Digilent Inc. Digilent-Pmod_Interface_Specification
POE	Port Output Enable
PWM	Pulse Width Modulation
RAM	Random Access Memory
ROM	Read Only Memory
RSK+	Renesas Starter Kit+
RTC	Real Time Clock
SCI	Serial Communications Interface
SPI	Serial Peripheral Interface
SSI	Serial Sound Interface
TFT	Thin Film Transistor
UART	Universal Asynchronous Receiver/Transmitter
USB	Universal Serial Bus
WDT	Watchdog Timer

All trademarks and registered trademarks are the property of their respective owners.

Table of Contents

1. Overview.....	9
1.1 Purpose.....	9
1.2 Features.....	9
1.3 Board specification.....	10
2. Power Supply	11
2.1 Requirements.....	11
2.2 Power-Up Behaviour.....	11
3. Board Layout	12
3.1 Component Layout.....	12
3.2 Board Dimensions.....	13
3.3 Component Placement	14
4. Connectivity	16
4.1 Internal Board Connections	16
4.2 Debugger Connections	17
5. User Circuitry	18
5.1 Reset Circuit	18
5.2 Clock Circuit.....	18
5.3 Switches.....	18
5.4 LEDs	19
5.5 Potentiometer.....	19
5.6 Pmod™	20
5.7 USB Serial Port.....	21
5.8 Controller Area Network (CAN).....	21
5.9 Ethernet.....	22
5.10 EtherCAT Slave Controller (ESC).....	24
5.11 Universal Serial Bus (USB).....	25
5.12 RS-485	26
5.13 External Bus.....	26
5.14 SDRAM	27
5.15 Renesas Serial Peripheral Interface (RSPI)	28
5.16 Quad Serial Peripheral Interface (QSPI)	28
5.17 I ² C Bus (Inter-IC Bus).....	28
5.18 SD Host Interface (SDHI).....	29
5.19 Delta-Sigma Modulation Interface (DSMIF).....	29
6. Configuration	30
6.1 Modifying the RSK+	30
6.2 MCU Operating Modes	30
6.3 E1/E2 Lite Debugger Configuration	31
6.4 Power Supply Configuration	32
6.5 Clock Configuration.....	32
6.6 Analog Power, ADC and DAC Configuration	33
6.7 BUS & SDRAM Configuration.....	34
6.8 CAN Configuration	37
6.9 DSMIF Configuration	37
6.10 EtherCAT Configuration	38
6.11 Ethernet Configuration.....	40
6.12 General IO & LED Configuration	42
6.13 I ² C & EEPROM Configuration.....	43
6.14 IRQ & Switch Configuration	43
6.15 MTU & POE Configuration.....	44
6.16 PMOD1 Configuration.....	46
6.17 PMOD2 Configuration.....	46

6.18	QSPI Configuration	47
6.19	RS-485 Configuration	47
6.20	RSPI Configuration	47
6.21	Serial & USB to Serial Configuration	48
6.22	SDHI Configuration	49
6.23	USB Configuration	50
7.	Headers	51
7.1	Application Headers	51
8.	Code Development	56
8.1	Overview	56
8.2	Compiler Restrictions	56
8.3	Mode Support	56
8.4	Debugging Support	56
8.5	Address Space.....	56
8.6	Note of Flash Access Window Setting Register	56
9.	Additional Information	57

1. Overview

1.1 Purpose

This CPU Board is an evaluation tool for Renesas microcontrollers. This manual describes the technical details of the CPU Board hardware.

1.2 Features

This RSK+ provides an evaluation of the following features:

- Renesas microcontroller programming
- User code debugging
- User circuitry such as switches, LEDs and a potentiometer
- Sample applications
- Sample peripheral device initialisation code

The RSK+ board contains all the circuitry required for microcontroller operation.

1.3 Board specification

Board specification was shown in **Table 1-1** below.

Table 1-1: Board Specification

Item	Specification
Microcontroller	Part No : R5F572MNDDDB or R5F572MNHDBD ^{*1}
	Package : 224-pin LFBGA
	On-Chip Memory : ROM 4MB, RAM 1MB
On-Board Memory	SDRAM: 128Mbit (Data width 32bit)
	I ² C EEPROM: 2Kbit
	I ² C EEPROM: 16Kbit (For EtherCAT)
	SPI Serial Flash: 32Mbit x 2
Input Clock	RX72M Main : 24MHz
	RX72M Sub : 32.768kHz
	RL78/G1C Main: 12MHz
	Ethernet PHY (for RMII) : 50MHz
Power Supply	DC Power Jack : 5 V Input
	Power Supply IC : 5V Input, 3.3V Output
	Power Supply IC : 3.3V Input, 3.3V Output (For SDHI)
	Power Supply IC : 5V Input, 5V Output (For USB Host)
Debug Interface	E1/E2 Lite 14-pin box header
DIP Switch	Mode Configuration : 4-pole x 1
	For EtherCAT ID or User I/O : 8-pole x 1
Push Switch	Reset Switch x 1
	User Switch x 3
Potentiometer (for ADC)	Single-turn, 10kΩ
LED	5V Power indicator: green x 1
	3.3V Power Indicator : green x 1
	User : green x 1, orange x 1, red x 2
	Ethernet Status: green x 2, yellow x 2
	EtherCAT: green x 3, red x 1, green/red x 1
Ethernet	Connector : RJ45 x 2
	PHY : Single Channel PHY x 2
SDHI ^{*2}	SD Card Slot (4-bit) x 1
RS-485	Connector ^{*3} : 2.54mm pitch, 6-pin x 1
	RS-485 Driver x1 (Full-Duplex)
CAN	Connector : 2.54mm pitch, 3-pin x 1
	CAN Driver : R2A25416SP ^{*4} x 1
USB	USB0-Function : USB-MiniB
	USB0-Host : USB-TypeA
USB to Serial Converter Interface	Connector : USB-MiniB
	Driver : RL78/G1C Microcontroller (Part No R5F10JBCANA)
Pmod™	PMOD1 : Angle type, 12-pin Connector
	PMOD2 ^{*3} : Straight type, 12-pin Connector
DSMIF	14-pin box header ^{*3}
Application Board Interface ^{*3}	2.54 mm pitch, 26-pin x 2 (JA1, JA2), 50-pin x 1 (JA3), 24-pin x 2 (JA5, JA6)

^{*1}: R5F572MNDDDB does not have a built-in security function, but R5F572MNHDBD has a built-in security function.

^{*2}: The RX72M Group incorporate an SD Host Interface (SDHI) which is compliant with the SD Specifications. When developing host devices that are compliant with the SD Specifications, the user must enter into the SD Host/Ancillary Product License Agreement (SD HALA).

^{*3}: The connector is not included in the product.

^{*4}: This CAN driver has Non-promotion status, so do not use this CAN driver on your system.

2. Power Supply

2.1 Requirements

This board has an optional centre-positive supply connector using a 2.0mm barrel power jack (PWR). The main power supply connected to PWR should supply a minimum of 10W to ensure full functionality. When the board is connected to another system then that system should supply power to the board.

This CPU board supports one external voltage input. Details of the external power supply connection are shown in **Table 2-1** and **Table 2-2** below. The default power configuration is shown in **bold, blue text**.

Table 2-1: PWR connector Requirements

Connector	Supply voltage
PWR	Input 5VDC

There are RSK+ products which supports the 12V voltage input. Since this board is supporting the 5V voltage input, be careful not to connect the power supply of a high-voltage output accidentally. Moreover, the main power supply connected to PWR should supply a minimum of 10W to ensure full functionality.

Table 2-2: Main Power Supply Requirements

J16 ^{*1} Setting	Supply Source	Board_5V	UC_VCC
Open	PWR connector/JA1-5V/Unregulated_VCC	5V	3.3V
Shorted	VBUS0	5V	3.3V

*1: The connector is not fitted to the RSK+.

2.2 Power-Up Behaviour

When the RSK+ is purchased, the RSK+ board has the 'Release' build of the example tutorial software pre-programmed into the Renesas microcontroller. Please consult the 'Renesas Starter Kit+ Smart Configurator Tutorial Manual' for further information of this example.

3. Board Layout

3.1 Component Layout

Figure 3-1 below shows the top component layout of the board.

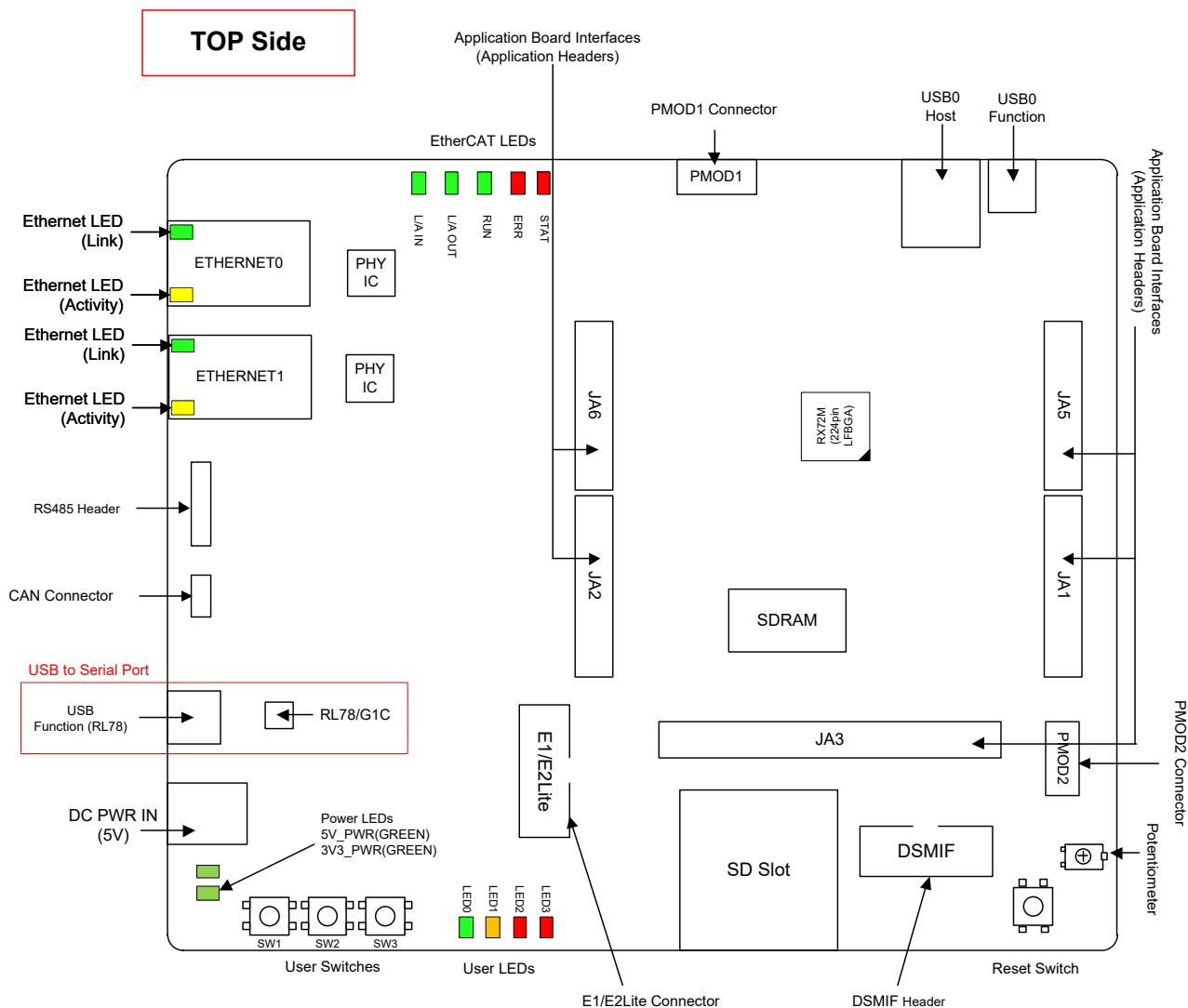

Figure 3-1: Board Layout

3.2 Board Dimensions

Figure 3-2 below gives the board dimensions and connector positions. All the through-hole connectors are on a common 2.54mm pitch grid for easy interfacing.

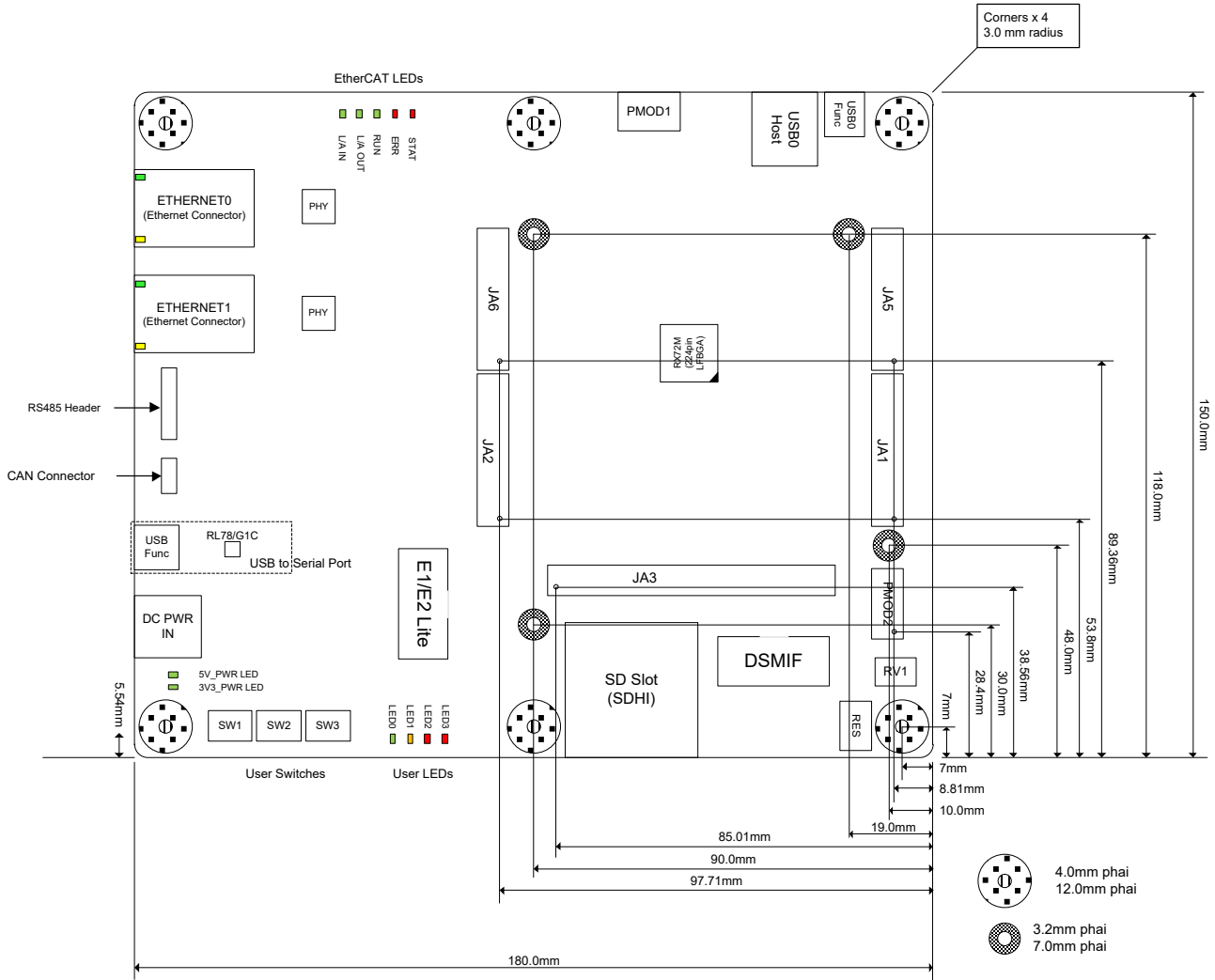

Figure 3-2: Board Dimensions

3.3 Component Placement

Figure 3-3 below shows placement of individual components on the top-side PCB – bottom-side component placement can be seen in Figure 3-4. Component types and values are shown on the board schematics.

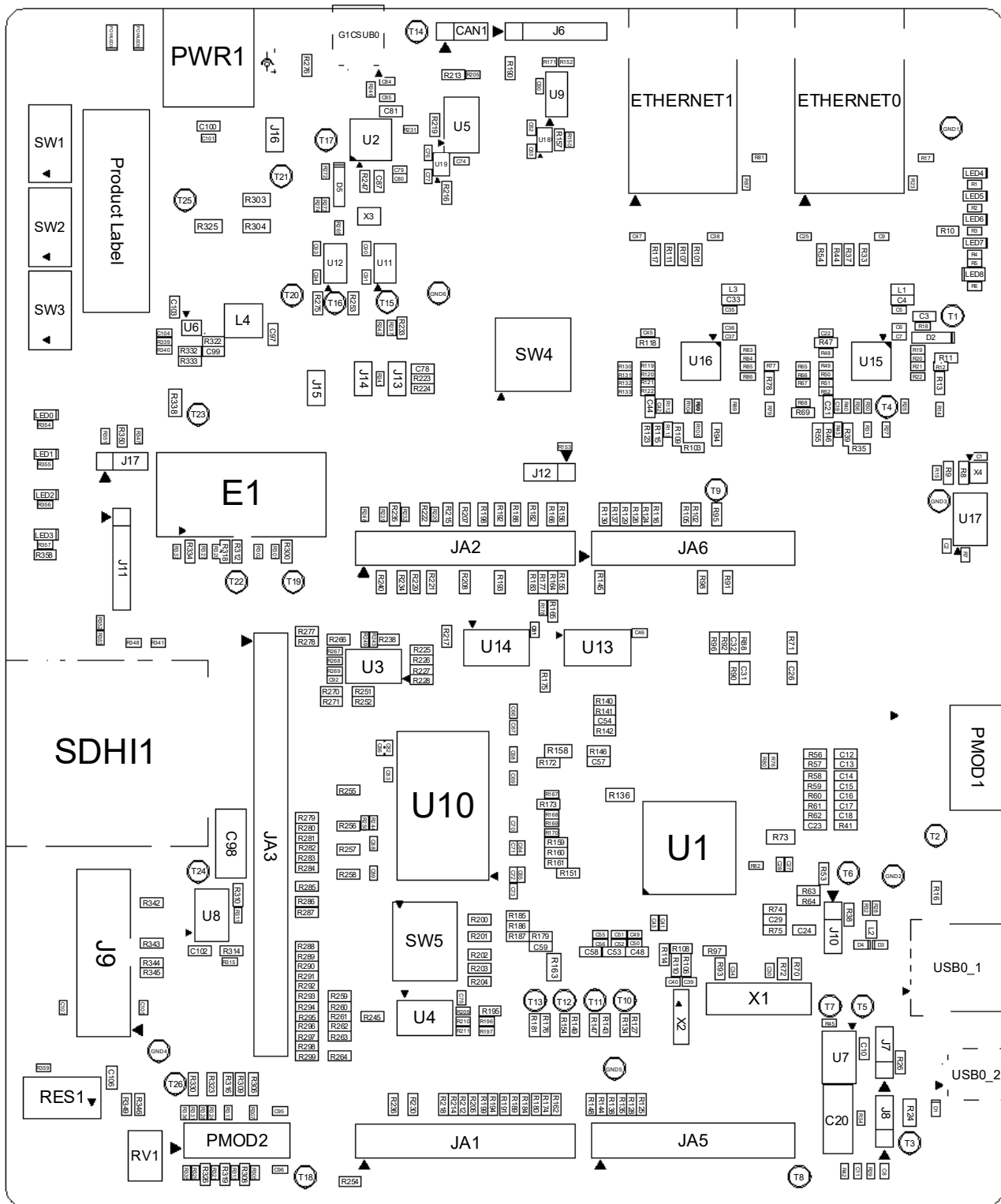

Figure 3-3: Top-Side Component Placement

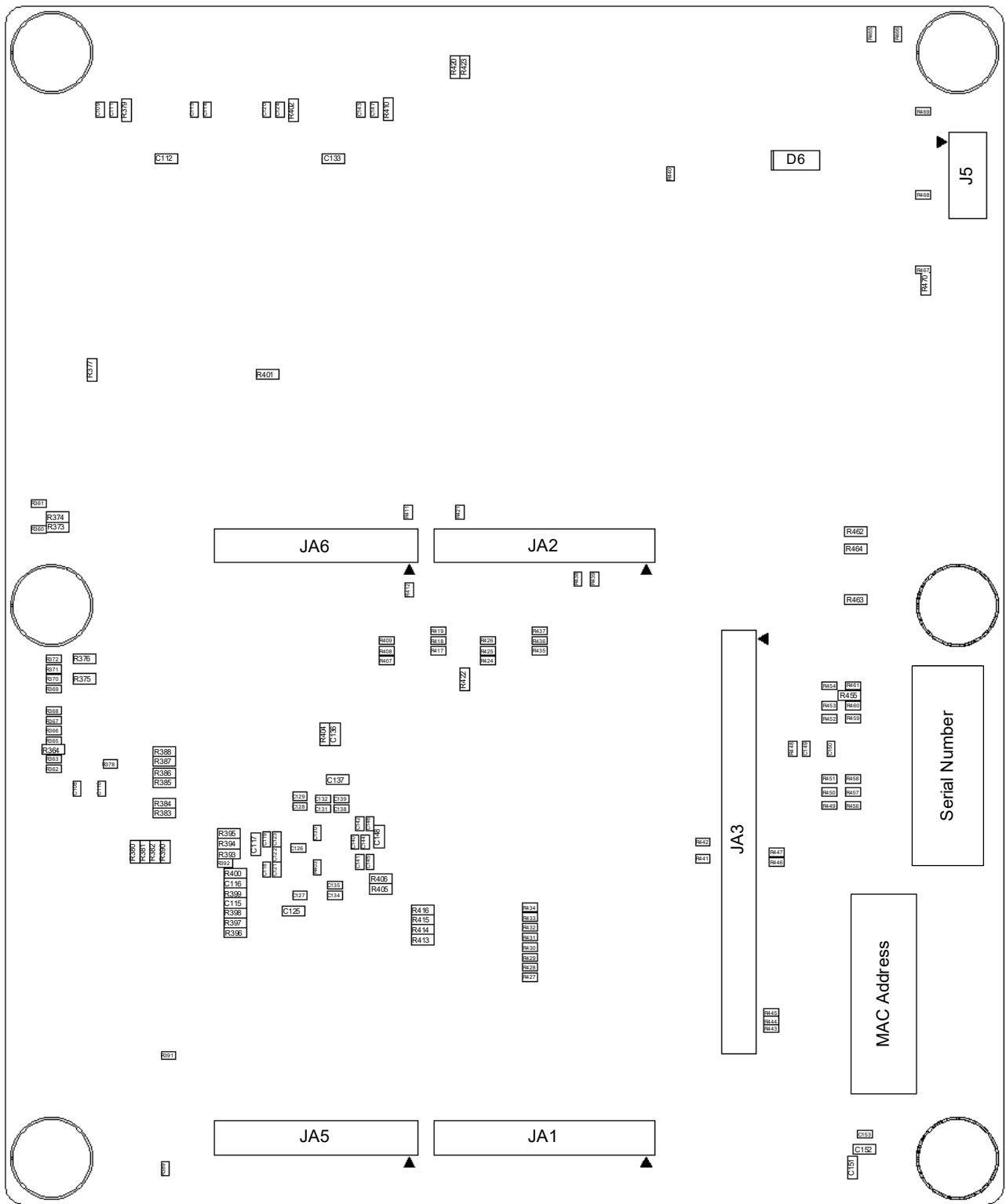

Figure 3-4: Bottom-Side Component Placement

4. Connectivity

4.1 Internal Board Connections

The diagram below shows the CPU board components and their connectivity to the MCU.

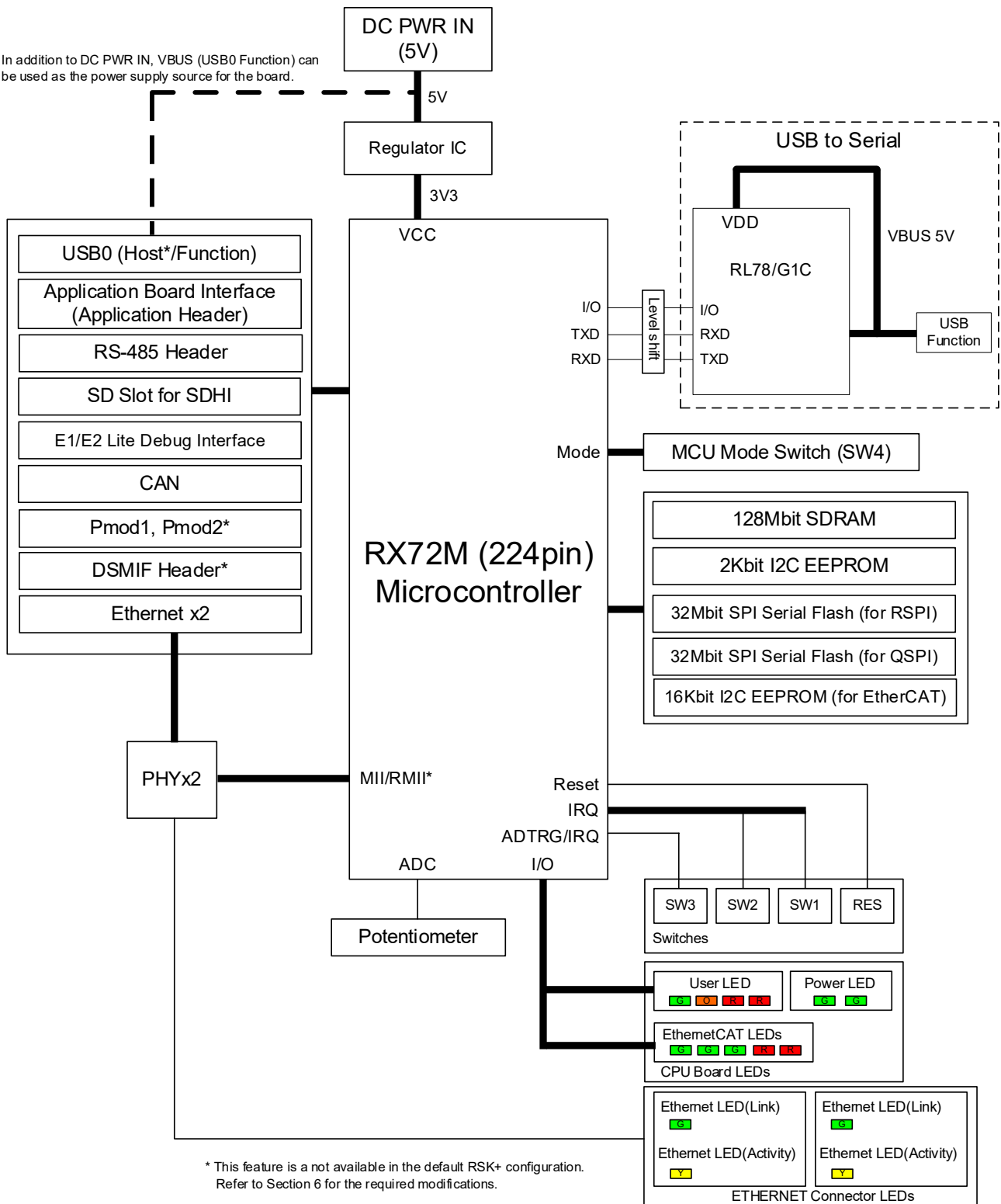

Figure 4-1: Internal Board Block Diagram

4.2 Debugger Connections

Figure 4-2 below shows the connections between the CPU board, E1/E2 Lite debugger and the host PC. The DSMIF connector is the same size as the E1/E2 Lite connector so be careful when connecting.

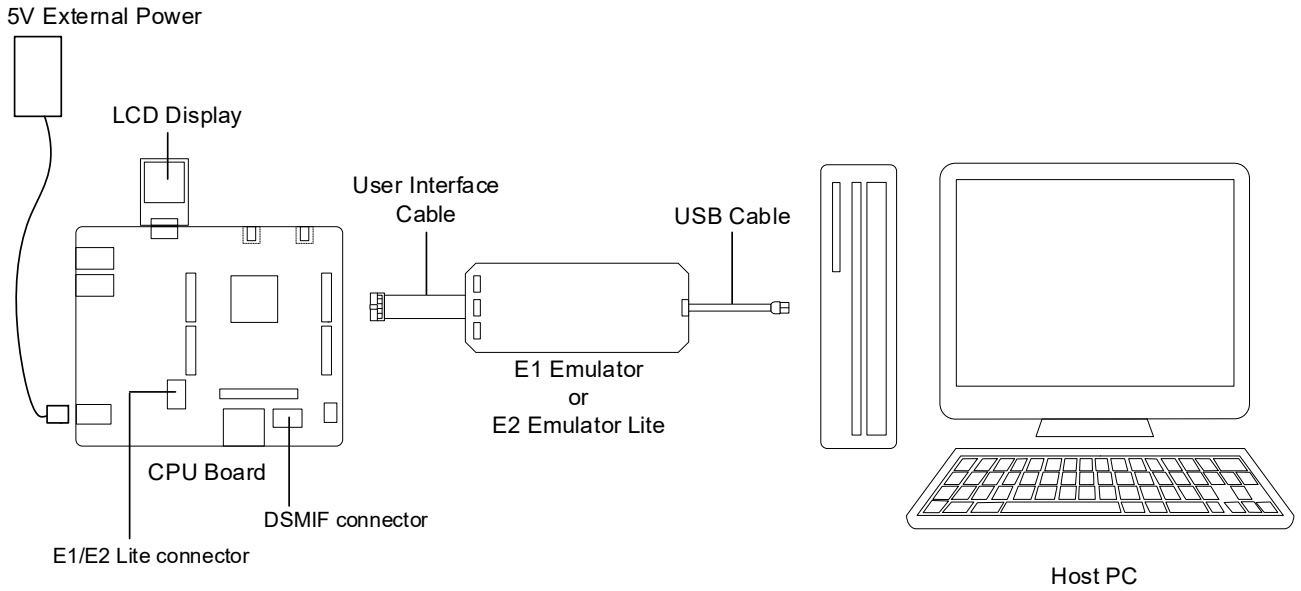

Figure 4-2: Debugger Connection Diagram

5. User Circuitry

5.1 Reset Circuit

A reset control circuit is fitted to the CPU board to generate the required reset signal, and is triggered from the RES switch. Refer to the RX72M Group User's Manual: Hardware for details regarding the reset signal timing requirements, and the CPU board schematics for information regarding the reset circuitry in use on the board.

5.2 Clock Circuit

A clock circuit is fitted to the CPU board to generate the required clock signal to drive the MCU, and associated peripherals. Refer to the RX72M Group Hardware Manual and the RL78/G1C hardware manual for details regarding the clock signal requirements, and the CPU board schematics for information regarding the clock circuitry in use on the CPU board. Details of the oscillators fitted to the board are listed in **Table 5-1** below.

Table 5-1: Crystal

Crystal	Function	Default Placement	Frequency	Device Package
X1	Main MCU crystal for RX72M	Fitted	24MHz	Encapsulated, SMT
X2	Real time Clock for RX72M	Fitted	32.768kHz	Encapsulated, SMT
X3	Main MCU crystal for RL78/G1C	Fitted	12MHz	Encapsulated, SMT
X4	Crystal for Ethernet (RMII)	Fitted	50MHz	Encapsulated, SMT

5.3 Switches

There are six switches located on the CPU board. The function of each switch and its connection is shown in **Table 5-2 and Table 5-3**. For further information regarding switch connectivity, refer to the CPU board schematics.

Table 5-2: Push Switch Connections

Switch	Function	MCU	
		Signal (Port)	Pin
RES	When pressed, the microcontroller is reset.	RES#	G7
SW1	Connects to an IRQ13-DS input for user controls.	P45	D1
SW2	Connects to an IRQ12-DS input for user controls.	P44	C4
SW3	Connects to an IRQ15 input for user controls. Connects to an ADTRG0 input for ADC controls.	P07	E5

Table 5-3: DIP Switch Connections

Switch	Pin	Function	MCU	
			Signal (Port)	Pin
SW4	Pin 1	Refer to section 6.2 for the setting contents.	MD/FINED	G4
	Pin 2	Refer to section 6.2 for the setting contents.	PC7	N9
	Pin 3	For PROFINET or User switch.	P60	C10
	Pin 4	For PROFINET or User switch.	PK3	J9
SW5	Pin 1	For EtherCAT-ID or User switch.	PH2	J6
	Pin 2	For EtherCAT-ID or User switch.	P46	B4
	Pin 3	For EtherCAT-ID or User switch.	PQ3	E9
	Pin 4	For EtherCAT-ID or User switch.	P05	C3
	Pin 5	For EtherCAT-ID or User switch.	P72	K15
	Pin 6	For EtherCAT-ID or User switch.	P47	D2
	Pin 7	For EtherCAT-ID or User switch.	PC1	N14
	Pin 8	For EtherCAT-ID or User switch.	PN5	J11

5.4 LEDs

There are 15 LEDs on the RSK+ board. The function of each LED, its colour, and its connections are shown in **Table 5-4**.

Table 5-4: LED Connections

LED	Colour	Function	MCU	
			Port	Pin
3V3 PWR	Green	Indicates the status of the Board_3V3 power rail.	NC	NC
5V PWR	Green	Indicates the status of the Board_5V power rail.	NC	NC
LED0	Green	User operated LED.	P42	B3
LED1	Orange	User operated LED.	PH0	N2
LED2	Red	User operated LED.	PN4	L12
LED3	Red	User operated LED.	P85	N4
LED4	Green	LED for EtherCAT-IN.	PK6	F7
LED5	Green	LED for EtherCAT-OUT.	PK7	P1
LED6	Green	LED for EtherCAT-RUN.	P15	J7
LED7	Red	LED for EtherCAT-ERR.	PH3	L1
LED8	Red	LED for EtherCAT-ERR.	PH3	L1
	Green	LED for EtherCAT-STAT.	PH4	K3
ETHERNET0 Connector	Green	Ethernet LED(Link with Activity / Link)	P34	H2
ETHERNET0 Connector	Yellow	Ethernet LED(Speed / Activity)	NC	NC
ETHERNET1 Connector	Green	Ethernet LED(Link with Activity / Link)	P84	M6
ETHERNET1 Connector	Yellow	Ethernet LED(Speed / Activity)	NC	NC

5.5 Potentiometer

A single-turn potentiometer is connected as a potential divider to analog input AN000, (Port P40, Pin D4). The potentiometer can be used to create a voltage between Board_3V3 and AVSS0. Refer to the maker site for specification of the potentiometer (VISHAY with part number TS53 series).

The potentiometer offers an easy method of supplying a variable analog input to the microcontroller. It does not necessarily reflect the accuracy of the controller's ADC. Refer to the RX72M Group User's Manual: Hardware for further details.

5.6 Pmod™

The RSK+ board is equipped with connectors for the Digilent Pmod™ interface. Please connect an LCD module that is compatible with the PMOD1 connector.

Care should be taken when installing the LCD module to ensure pins are not bent or damaged. The LCD module is vulnerable to electrostatic discharge (ESD); therefore appropriate ESD protection should be used.

The Digilent Pmod™ Compatible headers use an SPI interface. **Figure 5-1** below shows Digilent Pmod™ Compatible Header Pin Numbering. Connection information for the Digilent Pmod™ Compatible header is provided in **Table 5-5** and **Table 5-6** below.

Please note that the connector numbering adheres to the Digilent Pmod™ standard and is different from all other connectors on the RSK designs. Details can be found in the Digilent Pmod™ Interface Specification Revision: November 20, 2011.

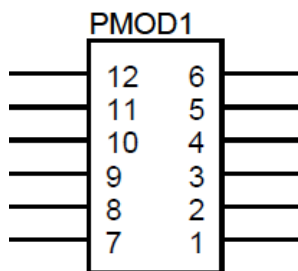

Figure 5-1: Digilent Pmod™ Compatible Header Pin Numbering

Table 5-5: Pmod™1 Header Connections

Digilent Pmod™ Compatible Header Connections							
Pin	Circuit Net Name	MCU		Pin	Circuit Net Name	MCU	
		Port	Pin			Port	Pin
1	PMOD1-CS	PC5	R10	7	PMOD1-IO0	P30	J5
2	PMOD1-MOSI	PJ2	L6	8	PMOD1-IO1	P02	D6
3	PMOD1-MISO	PC6	R9	9	PMOD1-IO2	PJ1	N6
4	PMOD1-SCK	PJ0	M5	10	PMOD1-IO3	PL1	J10
5	GROUND	-	-	11	GROUND	-	-
6	Board_3V3	-	-	12	Board_3V3	-	-

Table 5-6: Pmod™2 Header Connections

Digilent Pmod™ Compatible Header Connections							
Pin	Circuit Net Name	MCU		Pin	Circuit Net Name	MCU	
		Port	Pin			Port	Pin
1	PMOD2-CS	PJ5	G5	7	PMOD2-IO0 *1	P46	B4
2	PMOD2-MOSI *1	P50	K8	8	PMOD2-IO1 *1	P00	E3
3	PMOD2-MISO *1	P52	L8	9	PMOD2-IO2 *1	PQ3	E9
4	PMOD2-SCK *1	P51	M8	10	PMOD2-IO3 *1	P47	D2
5	GROUND	-	-	11	GROUND	-	-
6	Board_3V3	-	-	12	Board_3V3	-	-

*1: This connection is not available in the default RSK+ configuration - refer to §6 for the required modifications.

5.7 USB Serial Port

A USB serial port is implemented in a Renesas low power microcontroller (RL78/G1C) and is connected to the RX72M Serial Communications Interface (SCI) module. Multiple options are provided to allow the selection of the connected SCI6 port. Connections between the USB to Serial converter and the microcontroller are listed in **Table 5-7** below.

Table 5-7: Serial Port Connections

Signal Name	Function	MCU	
		Port	Pin
SERIAL-TXD	SCI1 Transmit Signal. *1	PF0	K5
	SCI6 Transmit Signal.	P00	E3
	External RS232 Transmit Signal. *1	-	-
SERIAL-RXD	SCI1 Receive Signal. *1	PF2	J2
	SCI6 Receive Signal.	P01	D5
	External RS232 Receive Signal. *1	-	-
SERIAL-CTS *2	Clear To Send.	P03	D3
SERIAL-RTS *2	Request To Send.	P43	E4

*1: This connection is a not available in the default RSK+ configuration - refer to §6 for the required modifications.

*2: Flow control is a signal provided for expansion and is not currently supported. There is no schedule of function expansion at present.

When the CPU board is first connected to a PC running Windows™ with the USB/Serial connection, the PC will look for a driver. This driver is installed during the installation process, so the PC should be able to find it. The PC will report that it is installing a driver and then report that a driver has been installed successfully, as shown in **Figure 5-2**. The exact messages may vary depending upon operating system.

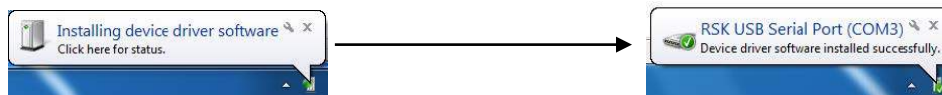

Figure 5-2: USB-Serial Windows™ Installation message

If you do not have the driver, please download the driver installer from the following URL.

<https://www.renesas.com/en-eu/software/D6000699.html>

5.8 Controller Area Network (CAN)

A CAN transceiver IC is fitted to the RSK+ board, and connected to the CAN MCU peripheral. For further details regarding the CAN protocol and supported modes of operation, please refer to the RX72M Group User’s Manual: Hardware. The connections for the CAN microcontroller signals are listed in **Table 5-8** below.

Table 5-8: CAN Connections

CAN Signal	Function	MCU	
		Port	Pin
CAN1TX	CAN Data Transmission.	P32	H5
JA5-CAN1TX *1			
CAN1RX	CAN Data Reception.	P33	H4
JA5-CAN1RX *1			

*1: This connection is a not available in the default RSK+ configuration - refer to §6 for the required modifications.

5.9 Ethernet

When running any Ethernet software, a unique MAC address should be used. A unique Renesas allocated MAC address is attached to the PCB as a sticker, and should be always be used with this device ensured to ensure full compatibility when using other Renesas hardware on a common Ethernet connection.

An Ethernet controller IC is fitted to the CPU board, and is connected to the Ethernet MCU peripheral. The RX72M MCU supports full duplex 10Mb/s and 100Mb/s transmission and reception. Refer to §5.4 for information about the Ethernet LEDs. The connections for the Ethernet controller are listed in **Table 5-9**, **Table 5-10**, **Table 5-11**, **Table 5-12** below.

Table 5-9: Ethernet Connections (ETHERNET0)

Ethernet signal	Function	MCU	
		Port	Pin
ET0-TXCLK	MII: Transmit clock	PM6	N13
ET0-TXEN_RMII0TXDEN	MII/RMII: Transmit data valid	PL6	M12
ET0-ETXD0_RMII0TXD0	MII/RMII: Transmit data 0	PL4	R12
ET0-ETXD1_RMII0TXD1	MII/RMII: Transmit data 1	PL5	M11
ET0-ETXD2	MII: Transmit data 2	PM4	P14
ET0-ETXD3	MII: Transmit data 3	PM5	R15
ET0-RXCLK	MII: Receive clock RMII: Reference clock *1	PL3	K10
ET0-RXER_RMII0RXER	MII/RMII: Receive error	PL2	P12
ET0-ERXD0_RMII0RXD0	MII/RMII: Receive data 0	P75	R13
ET0-ERXD1_RMII0RXD1	MII/RMII: Receive data 1	P74	R14
ET0-ERXD2	MII: Receive data 2	PK4	F4
ET0-ERXD3	MII: Receive data 3	PK5	F5
ET0-COL	MII: Collision detect signal	PK1	K9
ET0-CRS	MII: Carrier sense	PM7	M13
ET0-LED0	MII/RMII: Link status input from the PHY-LSI	P34	H2
ET0-RXDV_RMII0CRSDV	MII: Receive data valid	PK2	N11
	RMII: Carrier sense/receive data valid *1	PM7	M13

*1: This connection is a not available in the default RSK+ configuration - refer to §6 for the required modifications.

Table 5-10: Ethernet Connections (ETHERNET1)

Ethernet signal	Function	MCU	
		Port	Pin
ET1-TXCLK	MII: Transmit clock	PN2	G9
ET1-TXEN_RMII1TXDEN	MII/RMII: Transmit data valid	PQ7	H8
ET1-ETXD0_RMII1TXD0	MII/RMII: Transmit data 0	PQ5	E10
ET1-ETXD1_RMII1TXD1	MII/RMII: Transmit data 1	PQ6	F9
ET1-ETXD2	MII: Transmit data 2	PN0	E6
ET1-ETXD3	MII: Transmit data 3	PN1	F8
ET1-RXCLK	MII: Receive clock RMII: Reference clock *1	PQ4	E11
ET1-RXER_RMII1RXER	MII/RMII: Receive error	PN3	H9
ET1-ERXD0_RMII1RXD0	MII/RMII: Receive data 0	PM0	G11
ET1-ERXD1_RMII1RXD1	MII/RMII: Receive data 1	PM1	F11
ET1-ERXD2	MII: Receive data 2	PM2	K11
ET1-ERXD3	MII: Receive data 3	PM3	P15
ET1-COL	MII: Collision detect signal	PQ1	E8
ET1-CRS	MII: Carrier sense	PQ0	E7
ET1-LED0	MII/RMII: Link status input from the PHY-LSI	P84	M6
ET1-RXDV_RMII1CRSDV	MII: Receive data valid	PQ2	G8
	RMII: Carrier sense/receive data valid *1	PQ0	E7

*1: This connection is not available in the default RSK+ configuration - refer to §6 for the required modifications.

Table 5-11: Ethernet Connections (ETHERNET0/ETHERNET1)

Ethernet signal	Function	MCU	
		Port	Pin
CLKOUT25M	MII: For PHY clock 25MHz	PH7	K1
ET-MDIO	MII/RMII: Management data I/O	PL7	L10
ET-MDC	MII/RMII: Management data clock	PK0	M10
ET-RESn	PHY Reset	PJ3	H7
ET-INTn	PHY Interrupt	P31	J4

Table 5-12: Default PHY setting

Default PHY setting items	Default PHY setting contents
PHY Address	ETHERNET0(U15)=1, ETHERNET1(U16)=2
MII/RMII *1	MII
Isolate	Disable
Speed	100Mbps
Duplex	Full-Duplex
Auto negotiation	Enable

*1: RMII is not possible with EtherCAT

5.10 EtherCAT Slave Controller (ESC)

To run the EtherCAT slave controller software, the EtherCAT ID number is required. Please use SW5 as necessary.

The CPU board has an EtherCAT slave controller (ESC) and is connected to the ESC module of the microcontroller. EtherCAT status LEDs are listed in §5.4 and dip switches are listed in §5.3. The EtherCAT connections to and from the MCU are shown in **Table 5-13**, **Table 5-14**, **Table 5-15**.

Table 5-13: EtherCAT Connections (ECAT-IN)

EtherCAT signal	Function	MCU	
		Port	Pin
ET0-TXCLK	EtherCAT: Transmit clock	PM6	N13
ET0-TXEN_RMII0TXDEN	EtherCAT: Transmit data valid	PL6	M12
ET0-ETXD0_RMII0TXD0	EtherCAT: Transmit data 0	PL4	R12
ET0-ETXD1_RMII0TXD1	EtherCAT: Transmit data 1	PL5	M11
ET0-ETXD2	EtherCAT: Transmit data 2	PM4	P14
ET0-ETXD3	EtherCAT: Transmit data 3	PM5	R15
ET0-RXCLK	EtherCAT: Receive clock	PL3	K10
ET0-RXER_RMII0RXER	EtherCAT: Receive error	PL2	P12
ET0-ERXD0_RMII0RXD0	EtherCAT: Receive data 0	P75	R13
ET0-ERXD1_RMII0RXD1	EtherCAT: Receive data 1	P74	R14
ET0-ERXD2	EtherCAT: Receive data 2	PK4	F4
ET0-ERXD3	EtherCAT: Receive data 3	PK5	F5
ET0-RXDV_RMII0CRSDV	EtherCAT: Receive data valid	PK2	N11

Table 5-14: EtherCAT Connections (ECAT-OUT)

EtherCAT signal	Function	MCU	
		Port	Pin
ET1-TXCLK	EtherCAT: Transmit clock	PN2	G9
ET1-TXEN_RMII1TXDEN	EtherCAT: Transmit data valid	PQ7	H8
ET1-ETXD0_RMII1TXD0	EtherCAT: Transmit data 0	PQ5	E10
ET1-ETXD1_RMII1TXD1	EtherCAT: Transmit data 1	PQ6	F9
ET1-ETXD2	EtherCAT: Transmit data 2	PN0	E6
ET1-ETXD3	EtherCAT: Transmit data 3	PN1	F8
ET1-RXCLK	EtherCAT: Receive clock	PQ4	E11
ET1-RXER_RMII1RXER	EtherCAT: Receive error	PN3	H9
ET1-ERXD0_RMII1RXD0	EtherCAT: Receive data 0	PM0	G11
ET1-ERXD1_RMII1RXD1	EtherCAT: Receive data 1	PM1	F11
ET1-ERXD2	EtherCAT: Receive data 2	PM2	K11
ET1-ERXD3	EtherCAT: Receive data 3	PM3	P15
ET1-RXDV_RMII1CRSDV	EtherCAT: Receive data valid	PQ2	G8

Table 5-15: EtherCAT Connections (ECAT-IN/ECAT-OUT) *1

EtherCAT signal	Function	MCU	
		Port	Pin
CLKOUT25M	EtherCAT: For PHY clock 25MHz	PH7	K1
ET-MDIO	EtherCAT: Management data I/O	PL7	L10
ET-MDC	EtherCAT: Management data clock	PK0	M10
CATI2C-CLK	EtherCAT: I2C clock for slave configuration	PH1	K6
CATI2C-DATA	EtherCAT: I2C data for slave configuration	P82	P10
CATLATCH0	EtherCAT: External latch event input 0	PH5	K4
CATLATCH1	EtherCAT: External latch event input 1	PH6	K2
CATSYNC0	EtherCAT: SYNC output 0	PJ5	G5
CATSYNC1	EtherCAT: SYNC output 1	P11	P8
ET-RESn	PHY Reset	PJ3	H7
ET-INTn	PHY Interrupt	P27	L2

*1: For initial setting of PHY, refer to §5.9.

5.11 Universal Serial Bus (USB)

This CPU board is fitted with a USB Host socket (type A) and a Function socket (type Mini B). USB module USB0 is connected to the Host and Function socket, and can operate as either a Host or Function device. The connection for the USB0 module is shown in **Table 5-16** below.

Table 5-16: USB0 Module Connections

USB Signal	Function	MCU	
		Port	Pin
USB0-DP	D+ I/O pin of the USB on-chip transceiver	USB0_DP	R6
USB0-DM	D- I/O pin of the USB on-chip transceiver	USB0_DM	R5
USB0-VBUS	USB cable connection monitor pin	P16	R3
USB0-VBUSEN *1	VBUS (5V) supply enable signal for external power supply chip		
USB0-OVRCURA	External overcurrent detection signals	P14	P4

*1: This connection is not available in the default RSK+ configuration - refer to §6 for the required modifications.

5.12 RS-485

This CPU board has RS-485 transceiver and header. Connection relations of RS-485 are shown in **Table 5-17**, **Table 5-18**.

Table 5-17: RS-485 Transceiver Connections

Serial Signal	Function	MCU	
		Port	Pin
RS485-RXD	Serial Transmit data	P86	N3
RS485-TXD	Serial Receive data	PC7	N9
RS485-DE	RS-485 Transmit enable	PL0	H11

Table 5-18: RS-485 Header Connections

Header Pin	RS-485 Signal	Function
1	Board_5V	Board_5V ^{*1}
2	ARXP	Receive data +
3	BRXN	Receive data -
4	ZTXN	Transmit data -
5	YTXP	Transmit data +
6	GROUND	GROUND

^{*1}: Since it is not connected at the time of product shipment, please fit R190 if you want to enable it.

5.13 External Bus

The RX72M features an external data bus, which is connected to various devices on the CPU board. Details of the devices connected to the external data bus are listed in **Table 5-19** below. Further details of the devices connected to the external bus can be found in the board schematics.

Table 5-19: External Bus Address Space

Chip Select	Device Name	Device Description	Address Space
CS0	-	Unused	FF000000h – FFFFFFFFh (16Mbyte)
SDCS(SDRAM-SDCSn)	U10	128Mbit SDRAM	08000000h – 0FFFFFFFh (128Mbyte)
SDCS(JA3-CSb)	JA3	Application Header	08000000h – 0FFFFFFFh (128Mbyte)
CS1 – CS2	-	Unused	06000000h – 07FFFFFFh (2 x 16Mbyte)
CS3(JA3-CSa)	JA3	Application Header	05000000h – 05FFFFFFh (16Mbyte)
CS4 – CS5	-	Unused	03000000h – 04FFFFFFh (2 x 16Mbyte)
CS6(JA3-CSc)	JA3	Application Header	02000000h – 02FFFFFFh (16Mbyte)
CS7	-	Unused	01000000h – 01FFFFFFh (16Mbyte)

5.14 SDRAM

The RX72M features an SDRAM controller. It is connected to SDRAM on the CPU board with a 32-bit width. **Table 5-20** gives an Overview of the onboard SDRAM.

Table 5-20: Overview of the onboard SDRAM

Specification	Contents
Type name	MT48LC4M32B2P-6A
Constitution	1Meg x 32 x 4 bank
Capacity	128Mbit
Row address	12bit
Column address	8bit
Number of banks	4
Auto refresh period (tRFC)	Min. 60ns
Initialization auto refresh count	2
Precharge command period (tRP)	Min. 18ns
Auto refresh request interval	15.625us (64ms/4096)
CAS latency (CL)	2 @SDCLK:80MHz
Write recovery period (tWR)	Min. 12ns
ACTIVE-to-PRECHARGE command period (tRAS)	42ns - 12000ns
ACTIVE-to-READ or WRITE delay (tRCD)	Min. 18ns

When accessing SDRAM on the CPU board, make the following settings regardless of the operating frequency of the SDRAM clock. **Table 5-21** shows the On-board SDRAM settings.

Table 5-21: On-board SDRAM settings

Register name	Setting values	Setting details
External Bus Control Register 3 (PFBCR3.SDCLKDRV)	0b0	Use the pin with the SDCLK set for a frequency no higher than 60 MHz.
Drive Capacity Control Register (PORT6.DSCR)	0b0000000x	Normal drive output
Drive Capacity Control Register 2 (PORT6.DSCR2)		
Drive Capacity Control Register (PORT7.DSCR)	0bxxxxxxx0	
Drive Capacity Control Register 2 (PORT7.DSCR2)		
Drive Capacity Control Register (PORT9.DSCR)	0b00000000	
Drive Capacity Control Register 2 (PORT9.DSCR2)		
Drive Capacity Control Register (PORTA.DSCR)		
Drive Capacity Control Register 2 (PORTA.DSCR2)		
Drive Capacity Control Register (PORTB.DSCR)		
Drive Capacity Control Register 2 (PORTB.DSCR2)		
Drive Capacity Control Register (PORTD.DSCR)		
Drive Capacity Control Register 2 (PORTD.DSCR2)		
Drive Capacity Control Register (PORTE.DSCR)		
Drive Capacity Control Register 2 (PORTE.DSCR2)		
Drive Capacity Control Register (PORTG.DSCR)		
Drive Capacity Control Register 2 (PORTG.DSCR2)		

5.15 Renesas Serial Peripheral Interface (RSPI)

The RX72M features three Renesas Serial Peripheral Interface modules (Renesas SPI or RSPI). RSPI2 is connected to a 32Mbit Serial Flash. **Table 5-22** below details the connected devices, and their connections to the MCU.

Table 5-22: RSPI Connections

RSPI signal	Function	MCU	
		Port	Pin
RSPI-CS	Chip Select	P57	P7
RSPI-CLK	Clock	P56	N7
RSPI-MOSI	Master out slave in data	P54	R7
RSPI-MISO	Master in slave out data	P55	R8

5.16 Quad Serial Peripheral Interface (QSPI)

The RX72M features one Quad Serial Peripheral Interface module (QSPI). **Table 5-23** below details the connected device, and its connection to the MCU.

Table 5-23: QSPI Connections

QSPI signal	Function	MCU	
		Port	Pin
QSPI-CS	Chip Select	P76	N12
QSPI-CLK	Clock	P77	L11
QSPI-IO0	I/O Data0	PC3	R11
QSPI-IO1	I/O Data1	PC4	P11
QSPI-IO2	I/O Data2	P80	N10
QSPI-IO3	I/O Data3	P81	L9

5.17 I²C Bus (Inter-IC Bus)

The RX72M features three I²C (Inter-IC Bus) interface modules. RIIC0 is connected to a 2Kbit EEPROM. **Table 5-24** below details the connected device, and their connection to the MCU.

Table 5-24: I²C Bus Connections

I ² C Bus signal	Function	MCU	
		Port	Pin
E2P-SDA	Data	P13	N5
E2P-SCL	Clock	P12	R4

5.18 SD Host Interface (SDHI)

A SD Card Slot is fitted to the CPU board, and connected to the SD Host Interface (SDHI) MCU peripheral. For further details regarding the SDHI operation, please refer to the RX72M Group User's Manual: Hardware. The connections for the SDHI signals are listed in **Table 5-25** below.

Table 5-25: SDHI Connections

SD Card Slot (SD1)							
Pin	Circuit Net Name	MCU		Pin	Circuit Net Name	MCU	
		Port	Pin			Port	Pin
1	SDHI-D3	P17	P2	2	SDHI-CMD	P20	P3
3	GROUND	-	-	4	SDHI-PE(SDHI-VCC)	PF5	G6
5	SDHI-CLK	P21	R1	6	GROUND	-	-
7	SDHI-D0	P22	N1	8	SDHI-D1	P23	M2
9	SDHI-D2	P87	R2	10	SDHI-CD	P25	M3
11	GROUND	-	-	12	SDHI-WP	P24	L4

5.19 Delta-Sigma Modulation Interface (DSMIF)

The RX72M microcontroller has six channels of Delta-Sigma Modulation Interface (DSMIF), of which 4 channels are connected to the 14 pin connector for DSMIF. **Table 5-26** shows the connection relationship.

Table 5-26: DSMIF Connections

DSMIF *1							
Pin	Circuit Net Name	MCU		Pin	Circuit Net Name	MCU	
		Port	Pin			Port	Pin
1	Board_5V	-	-	2	Board_3V3	-	-
3	Board_5V	-	-	4	Board_3V3	-	-
5	DSMCLK3	P71	J13	6	DSMDATA3 *2	P72	K15
7	DSMCLK2 *2	P74	R14	8	DSMDATA2 *2	P75	R13
9	DSMCLK1	P83	M9	10	DSMDATA1 *2	P56	N7
11	DSMCLK0 *2	P33	H4	12	DSMDATA0 *2	P34	H2
13	GROUND	-	-	14	GROUND	-	-

*1: Note that the number of pins and the pitch width are the same as the E1 / E2Lite interface.

*2 This connection is a not available in the default RSK+ configuration - refer to §6 for the required modifications.

6. Configuration

6.1 Modifying the RSK+

This section lists the option links that are used to modify the way CPU board operates in order to access different configurations. Configurations are made by modifying link resistors or headers with movable jumpers or by configuration DIP switches

A link resistor is a 0Ω surface mount resistor, which is used to short or isolate parts of a circuit. Option links are listed in the following sections, detailing their function when fitted or removed. **Bold, blue text** indicates the default configuration that the CPU board is supplied with. Refer to the component placement diagram (§3) to locate the option links, jumpers and DIP switches.

When removing soldered components, always ensure that the CPU board is not exposed to a soldering iron for intervals greater than 5 seconds. This is to avoid damage to nearby components mounted on the board.

When modifying a link resistor, always check the related option links to ensure there is no possible signal contention or short circuits. Because many of the MCU's pins are multiplexed, some of the peripherals must be used exclusively. Refer to the RX72M Group User's Manual: Hardware and CPU board schematics for further information.

In the table in this section, "pin" expression is omitted, so please read as follows.

Example: U9.4 -> U9.4pin

J7(1-2 short) -> J7(1pin-2pin short)

6.2 MCU Operating Modes

Table 6-1 below details the option links associated with configuring the MCU Operating Modes.

Table 6-1: MCU Operating Modes Switch Settings

SW4 Pin1	SW4 Pin2	J14 ^{*1}	Configuration	Related Links.
OFF	OFF(don't care)	Open(don't care)	Single Chip Mode	R153 , R166, R156, J12
OFF	OFF	Open(don't care)	Boot Mode(FINE Interface)	R153 , R166, R156, J12
ON	OFF	don't care	SCI Boot Mode	R153 , R166, R156, J12
ON	ON	Open	USB Boot Mode (Bus-powered)	R153 , R166, R156, J12
		Shorted	USB Boot Mode (Self-powered)	R153 , R166, R156, J12

^{*1}: Jumper J14 is not mounted on the board at the time of product shipment.

6.3 E1/E2 Lite Debugger Configuration

Table 6-2 below details the function of the option links associated with E1/E2 Lite Debugger Configuration.

Table 6-2: E1/E2 Lite Debugger Configuration Option Links

Signal name	MCU		MCU Peripheral Selection			Destination Selection		
	Pin	Port	Signal	Fit	DNF	Interface /Function	Fit	DNF
PC7	N9	PC7	RS485-TXD	J12 (1-2pin short)	R166, R156	U9.4	-	-
			EMU-UB	J12	R166, R156	E1.10	-	-
			DSW-UB	(2-3pin short)		SW4.2	-	-
			JA2-M1TRDCLK	R166	J12 (open) , R156	JA2.26	-	-
			JA6-TXDc	R156	J12 (open) , R166	JA6.9	-	-
EMU-TRSTn	F3	PF4	EMU-TRSTn	-	-	E1.3	-	-
EMU-TMS	J3	PF3	EMU-TMS	-	-	E1.9	-	-
PF2	J2	PF2	EMU-TDI_RXD	R300	R126, R234	E1.11	-	-
			SERIAL-RXD	R126	R300, R234	U12.3	-	R129, R253
			JA2-RXDa	R234	R300, R126	JA2.8	-	-
PF1	L3	PF1	EMU-TCK	R397, R398	R396	E1.1	-	-
			JA2-SCKa	R396, R398	R397	JA2.10	-	-
PF0	K5	PF0	EMU-TDO_TXD	R318	R312, R235	E1.5	-	-
			SERIAL-TXD	R312	R318, R235	U11.3	-	R137, R233
			JA2-TXDa	R235	R318, R312	JA2.6	-	-
RESn	G7	-	EMU-RESn	-	-	E1.13	-	-
			SW-RESn	-	-	RES1(Switch)	-	-
			JA2-RESn	-	-	JA2.1	-	-
EMLE	F6	-	EMU-EMLE	-	-	E1.4	-	-
			JP-EMLE	-	-	J17.2	R350	-
MD_FINED	G4	-	EMU-MD_FINED	-	-	E1.7	-	-
			DSW-MD_FINED	-	-	SW4.1	-	-

Table 6-3 below details the function of the jumpers associated with the E1/E2 Lite Debugger.

Table 6-3: E1/E2 Lite Debugger Configuration Jumper Settings

Reference	Jumper Position	Configuration	Related Links.
J17(DNF) *1	Shorted Pin1-2	Enable E1/E2 Lite normal debugging and MCU single operation (without E1/E2 Lite).	R350
	Shorted Pin2-3	Enable E1/E2 Lite debugging with Hot plug-in function.	-
	All open	DO NOT SET	-

*1: Jumper J17 is not fitted on the default CPU board. Same as Jumper Position “shorted pin1-2” setting by resistor R350.

6.4 Power Supply Configuration

Table 6-4 below details the function of the option links associated with Power Supply Configuration.

Table 6-4: Power Supply Configuration Option Links

Reference	Configuration	Fit	DNF	Related Links.
VBUS0	Connect 5V Power rail to VBUS0.	J16.shorted, J8.Pin1-2	-	U6.1 , U6.2
Unregulated_VCC	Connect 5V power rail to Unregulated_VCC.	R304	-	U6.1 , U6.2
JA1-5V	Connect 5V power rail to JA1-5V.	R325	-	U6.1 , U6.2
USB_5V	Connect 5V power rail to USB_5V.	R303	-	U7.2 , U7.3
Board_5V	Connect 5V power rail to Board_5V.	-	-	U6.1 , U6.2 , U3.8
SD_3V3	Connect 3.3V power rail to SD_3V3.	R338	-	U8.2 , U8.3
JA1-3V3	Connect 3.3V power rail to JA1-3V3.	R254	-	JA1.3
Board_3V3	Connect 3.3V power rail to Board_3V3.	-	-	U3.8
UC_VCC	Connect 3.3V power rail to UC_VCC.	J15.Short or (R158 or R73 or R163 or R136)	-	U1 , R53 , R143 , R154
	Enable current probe for measurement MCU current consumption.	-	J15.Open and (R158 , R73 , R163 , R136)	U1 , R53 , R143 , R154
VBATT	Connect UC_VCC power rail to VBATT.	R224	R223	U1
	J13 ^{*1} connected to VBATT of MCU	R223	R224	U1

*1: J13 is a power connector for VBATT, not a jumper. Do not short-circuit J13 Pin 1 and Pin 2 because the power supply is directly connected to ground.

Table 6-5 below details the function of the jumpers associated with the Power Supply Configuration.

Table 6-5: Power Supply Configuration Jumper Settings

Reference	Jumper Position	Configuration	Related Links.
J15(DNF) ^{*1}	Shorted	Connect 3.3V power rail to UC_VCC.	R158 , R73 , R163 , R136
	All open	Enable current probe for measurement MCU current consumption.	
J16(DNF) ^{*2}	Shorted	Enable VBUS0.	J7
	All open	Disable VBUS0	J7

*1: Jumper J15 is not fitted on the default CPU board. Fitting resistor R136 has the same effect as "shorting" jumper J15.

*2: Jumper J16 is not fitted on the default CPU board.

6.5 Clock Configuration

Table 6-6 below details the function of the option links associated with Clock Configuration.

Table 6-6: Clock Configuration Option Links

Reference	Configuration	Fit	DNF	Related Links.
XTAL, EXTAL	Connect 24MHz crystal (X1) to RX72M.	R72 , R93	R70	U1.H1 , U1.J1
	Connect JA2-EXTAL to RX72M.	R70	R72 , R93 , R97	U1.J1
XCIN, XCOU	Connect 32.768kHz crystal (X2) to RX72M.	R110 , R106	R114	U1.F1 , U1.G1
	Disconnect X2 from RX72M.	R114	R110 , R106	-

6.6 Analog Power, ADC and DAC Configuration

Table 6-7 below details the function of the option links associated with Analog Power, ADC and DAC Configuration.

Table 6-7: Analog Power, ADC and DAC Configuration Option Links

Signal name	MCU		MCU Peripheral Selection			Destination Selection		
	P _{in}	P _{ot}	Signal	Fit	DNF	Interface /Function	Fit	DNF
P07 ^{*1}	E5	P07	SW3	R470	R236, R174	SW3	-	-
			JA1-ADTRG	R236	R470, R174	JA1.8	-	-
			JA1-IRQd	R174	R470, R236	JA1.23	-	-
P05	C3	P05	DSW-CATID3	R201	R214	SW5.13	-	-
			JA1-DAC1	R214	R201	JA1.14	-	-
P03	D3	P03	SERIAL-CTS	R275	R218	U12.2	-	-
			JA1-DAC0	R218	R275	JA1.13	-	-
P43	E4	P43	SERIAL-RTS	R414	R413	U11.2	-	-
			JA1-ADC3	R413	R414	JA1.12	-	-
P42	B3	P42	LED0	R416	R415	LED0.K	R358	-
			JA1-ADC2	R415	R416	JA1.11	-	-
P41	A4	P41	SDHI-POWFLT	R310	R230	U8.5	-	-
			JA1-ADC1	R230	R310	JA1.10	-	-
P40	D4	P40	RV1-ADC	R406	R405	RV1	-	-
			JA1-ADC0	R405	R406	JA1.9	-	-
PE5	C13	PE5	SDRAM-D13	R287	R135	U10.82	-	-
			JA3-D13			JA3.34	-	-
			JA5-ADC7	R135	R287	JA5.4	-	-
PE4	B14	PE4	SDRAM-D12	R286	R138	U10.80	-	-
			JA3-D12			JA3.33	-	-
			JA5-ADC6	R138	R286	JA5.3	-	-
PE3	D12	PE3	SDRAM-D11	R258	R144	U10.79	-	-
			JA3-D11			JA3.32	-	-
			JA5-ADC5	R144	R258	JA5.2	-	-
PE2	B13	PE2	SDRAM-D10	R285	R148	U10.77	-	-
			JA3-D10			JA3.31	-	-
			JA5-ADC4	R148	R285	JA5.1	-	-
VREFH0	A2	-	UC_VCC	R154	R149	-	-	-
			JA1-VREFH	R149	R154	JA1.7	-	-
VREFL0	A3	-	GROUND	R181	R176	-	-	-
			JA1-AVSS	R176	R181	JA1.6	-	-
AVCC0-1	B2, C2	-	UC_VCC	R143	R346, R147 or R349, R147	-	-	-
			JA1-AVCC	R147	R346, R143 or R349, R143	JA1.5	-	-
			Board_3V3	R349, R346	R143, R147	-	-	-
AVSS0-1	B1, C1	-	GROUND	R134	R127	-	-	-
			JA1-AVSS	R127	R134	JA1.6	-	-

*1: When changing the option link of P07, pay attention to the presence or absence of a pull-up resistor. Leave the pull-up resistor for SW3 (R467) fitted, otherwise the internal pull-up in the MCU will need to be enabled.

6.7 BUS & SDRAM Configuration

Table 6-8, Table 6-9, Table 6-10 below details the function of the option links associated with BUS & SDRAM Configuration.

Table 6-8: BUS & SDRAM Configuration Option Links(1)

Signal name	MCU		MCU Peripheral Selection			Destination Selection		
	Pin	Port	Signal	Fit	DNF	Interface /Function	Fit	DNF
P10	K7	P10	JA3-ALE	R245	R184, R91	JA3.46	R295	R296
			JA1-IO6	R184	R245, R91	JA1.21	-	-
			JA6-M1WIN	R91	R245, R184	JA6.16	-	-
JA3-CSc	M1	P26	JA3-CSc	-	-	JA3.45	R294	R260
JA3-BCLK	J8	P53	JA3-BCLK	R60	-	JA3.44	R293	R259
P52	L8	P52	JA3-RDn	R279	R308	JA3.25	-	-
			PMOD2-MISO	R308	R279	PMOD2.3	-	-
P51	M8	P51	JA3-WRHn	R385	R386	JA3.47	R298	R299
			PMOD2-SCK	R386	R385	PMOD2.4	-	-
P50	K8	P50	JA3-WRn	R283	R263, R319	JA3.26	R282	R281
			JA3-WRLn	R263	R283, R319	JA3.48	R297	R151
			PMOD2-MOSI	R319	R283, R263	PMOD2.2	-	-
P67	D15	P67	SDRAM-DQM1	R257	R264	U10.71	-	-
			JA3-DQMH	R264	R257	JA3.47	R299	R298
P66	C15	P66	SDRAM-DQM0	R160	R161	U10.16	-	-
			JA3-DQML	R161	R160	JA3.48	R151	R297
P65	C14	P65	SDRAM-CKE	R256	R262	U10.67	-	-
			JA3-CKE	R262	R256	JA3.46	R296	R295
P64	C11	P64	SDRAM-WEn	R159	R280	U10.17	-	-
			JA3-WEn	R280	R159	JA3.26	R281	R282
P63	B12	P63	SDRAM-CASn	-	-	U10.18	-	-
			JA3-CAS	-	-	JA3.49	-	-
P62	A13	P62	SDRAM-RASn	-	-	U10.19	-	-
			JA3-RAS	-	-	JA3.50	-	-
P61	A12	P61	SDRAM-SDCSn	R173	R284	U10.20	-	-
			JA3-CSb	R284	R173	JA3.28	-	-
JA3-CSa	H10	P73	JA3-CSa	-	-	JA3.27	-	-
P70	A15	P70	SDRAM-SDCLK	R140, R142	R141	U10.68	-	-
			JA3-SDCLK	R141, R142	R140	JA3.44	R259	R293
SDRAM-D23	C9	P97	SDRAM-D23	-	-	U10.42	-	-
SDRAM-D22	A8	P96	SDRAM-D22	-	-	U10.40	-	-
SDRAM-D21	B8	P95	SDRAM-D21	-	-	U10.39	-	-
SDRAM-D20	B7	P94	SDRAM-D20	-	-	U10.37	-	-
SDRAM-D19	D7	P93	SDRAM-D19	-	-	U10.36	-	-
SDRAM-D18	A5	P92	SDRAM-D18	-	-	U10.34	-	-
SDRAM-D17	B5	P91	SDRAM-D17	-	-	U10.33	-	-
SDRAM-D16	C6	P90	SDRAM-D16	-	-	U10.31	-	-

Table 6-9: BUS & SDRAM Configuration Option Links(2)

Signal name	MCU		MCU Peripheral Selection			Destination Selection		
	Pin	Port	Signal	Fit	DNF	Interface /Function	Fit	DNF
PA7	J15	PA7	SDRAM-A7	-	-	U10.62	-	-
			JA3-A7	-	-	JA3.8	-	-
PA6	H14	PA6	SDRAM-A6	-	-	U10.61	-	-
			JA3-A6	-	-	JA3.7	-	-
PA5	H15	PA5	SDRAM-A5	-	-	U10.60	-	-
			JA3-A5	-	-	JA3.6	-	-
PA4	G15	PA4	SDRAM-A4	-	-	U10.27	-	-
			JA3-A4	-	-	JA3.5	-	-
PA3	G14	PA3	SDRAM-A3	-	-	U10.26	-	-
			JA3-A3	-	-	JA3.4	-	-
PA2	G13	PA2	SDRAM-A2	-	-	U10.25	-	-
			JA3-A2	-	-	JA3.3	-	-
PA1	G12	PA1	SDRAM-DQM3	R255, R278	-	U10.59	-	-
			JA3-A1	R255, R278	-	JA3.2	-	-
PA0	F12	PA0	SDRAM-DQM2	R172	R277	U10.28	-	-
			JA3-A0	R277	R172	JA3.1	-	-
PB7	N15	PB7	SDRAM-A15	-	-	U10.23	-	-
			JA3-A15	-	-	JA3.16	-	-
PB6	M15	PB6	SDRAM-A14	-	-	U10.22	-	-
			JA3-A14	-	-	JA3.15	-	-
PB5	K13	PB5	SDRAM-A13	-	-	U10.21	-	-
			JA3-A13	-	-	JA3.14	-	-
PB4	L15	PB4	SDRAM-A12	-	-	U10.24	-	-
			JA3-A12	-	-	JA3.13	-	-
PB3	K14	PB3	SDRAM-A11	-	-	U10.66	-	-
			JA3-A11	-	-	JA3.12	-	-
PB2	L14	PB2	SDRAM-A10	-	-	U10.65	-	-
			JA3-A10	-	-	JA3.11	-	-
PB1	J12	PB1	SDRAM-A9	-	-	U10.64	-	-
			JA3-A9	-	-	JA3.10	-	-
PB0	J14	PB0	SDRAM-A8	-	-	U10.63	-	-
			JA3-A8	-	-	JA3.9	-	-
PC6	R9	PC6	JA3-A22	R292	R364	JA3.43	-	-
			PMOD1-MISO	R364	R292	PMOD1.3	-	-
PC5	R10	PC5	JA3-A21	R291	R375	JA3.42	-	-
			PMOD1-CS	R375	R291	PMOD1.1	-	-
PC4	P11	PC4	QSPI-IO1	R217, R88	R290, R155	U14.2	-	-
			JA3-A20	R290, R88	R217, R155	JA3.41	-	-
			JA2-M1POE	R155, R88	R217, R290	JA2.24	-	-
PC3	R11	PC3	QSPI-IO0	R422	R289	U14.5	-	-
			JA3-A19	R289	R422	JA3.40	-	-
JA3-A18	P13	PC2	JA3-A18	-	-	JA3.39	-	-
PC1	N14	PC1	JA3-A17	R288	R98, R203	JA3.38	-	-
			DSW-CATID6	R203	R288, R98	SW5.10	-	-
			JA6-M1TOGGLE	R98	R288, R203	JA6.13	-	-
JA3-A16	M14	PC0	JA3-A16	-	-	JA3.37	-	-

Table 6-10: BUS & SDRAM Configuration Option Links(3)

Signal name	MCU		MCU Peripheral Selection			Destination Selection		
	Pin	Port	Signal	Fit	DNF	Interface /Function	Fit	DNF
PD7	A11	PD7	SDRAM-D7	-	-	U10.13	-	-
			JA3-D7	-	-	JA3.24	-	-
PD6	B10	PD6	SDRAM-D6	-	-	U10.11	-	-
			JA3-D6	-	-	JA3.23	-	-
PD5	D9	PD5	SDRAM-D5	-	-	U10.10	-	-
			JA3-D5	-	-	JA3.22	-	-
PD4	B9	PD4	SDRAM-D4	-	-	U10.8	-	-
			JA3-D4	-	-	JA3.21	-	-
PD3	A9	PD3	SDRAM-D3	-	-	U10.7	-	-
			JA3-D3	-	-	JA3.20	-	-
PD2	A7	PD2	SDRAM-D2	-	-	U10.5	-	-
			JA3-D2	-	-	JA3.19	-	-
PD1	C7	PD1	SDRAM-D1	-	-	U10.4	-	-
			JA3-D1	-	-	JA3.18	-	-
PD0	A6	PD0	SDRAM-D0	-	-	U10.2	-	-
			JA3-D0	-	-	JA3.17	-	-
PE7	B15	PE7	SDRAM-D15	-	-	U10.85	-	-
			JA3-D15	-	-	JA3.36	-	-
PE6	E13	PE6	SDRAM-D14	-	-	U10.83	-	-
			JA3-D14	-	-	JA3.35	-	-
PE5	C13	PE5	SDRAM-D13	R287	R135	U10.82	-	-
			JA3-D13			JA3.34	-	-
			JA5-ADC7	R135	R287	JA5.4	-	-
PE4	B14	PE4	SDRAM-D12	R286	R138	U10.80	-	-
			JA3-D12			JA3.33	-	-
			JA5-ADC6	R138	R286	JA5.3	-	-
PE3	D12	PE3	SDRAM-D11	R258	R144	U10.79	-	-
			JA3-D11			JA3.32	-	-
			JA5-ADC5	R144	R258	JA5.2	-	-
PE2	B13	PE2	SDRAM-D10	R285	R148	U10.77	-	-
			JA3-D10			JA3.31	-	-
			JA5-ADC4	R148	R285	JA5.1	-	-
PE1	A14	PE1	SDRAM-D9	-	-	U10.76	-	-
			JA3-D9	-	-	JA3.30	-	-
PE0	D11	PE0	SDRAM-D8	-	-	U10.74	-	-
			JA3-D8	-	-	JA3.29	-	-
PF5	G6	PF5	SDHI-PE	R314	R261, R191	U8.4	-	-
			JA3-WAIT	R261	R314, R191	JA3.45	R260	R294
			JA1-IO4	R191	R314, R261	JA1.19	-	-
SDRAM-D31	F15	PG7	SDRAM-D31	-	-	U10.56	-	-
SDRAM-D30	F14	PG6	SDRAM-D30	-	-	U10.54	-	-
SDRAM-D29	E14	PG5	SDRAM-D29	-	-	U10.53	-	-
SDRAM-D28	E15	PG4	SDRAM-D28	-	-	U10.51	-	-
SDRAM-D27	F13	PG3	SDRAM-D27	-	-	U10.50	-	-
SDRAM-D26	D14	PG2	SDRAM-D26	-	-	U10.48	-	-
SDRAM-D25	D10	PG1	SDRAM-D25	-	-	U10.47	-	-
SDRAM-D24	A10	PG0	SDRAM-D24	-	-	U10.45	-	-

6.8 CAN Configuration

Table 6-11 below details the function of the option links associated with CAN Configuration.

Table 6-11: CAN Configuration Option Links

Signal name	MCU		MCU Peripheral Selection			Destination Selection		
	Pin	Port	Signal	Fit	DNF	Interface /Function	Fit	DNF
P33	H4	P33	CAN1RX	R185, R179	R186, R187	U5.4	-	-
			DSMCLK0	R186, R179	R185, R187	J9.11	-	-
			JA5-CAN1RX	R187, R179	R185, R186	JA5.6	-	-
P32	H5	P32	CAN1TX	R216	R125, R128	U19.3	-	-
			JA2-IRQc_M1HSIN2	R125	R216, R128	JA2.23	R177	R164
			JA5-CAN1TX	R128	R216, R125	JA5.5	-	-

6.9 DSMIF Configuration

Table 6-12 below details the function of the option links associated with DSMIF Configuration.

Table 6-12: DSMIF Configuration Option Links

Signal name	MCU		MCU Peripheral Selection			Destination Selection		
	Pin	Port	Signal	Fit	DNF	Interface /Function	Fit	DNF
P34	H2	P34	ET0-LED0	R11	R342, R229	ETHERNET0.11	-	-
			DSMDAT0	R342	R11, R229	U15.30	-	-
			JA2-IRQa-M1HSIN0	R229	R11, R342	JA2.7	-	-
P33	H4	P33	CAN1RX	R185, R179	R186, R187	U5.4	-	-
			DSMCLK0	R186, R179	R185, R187	J9.11	-	-
			JA5-CAN1RX	R187, R179	R185, R186	JA5.6	-	-
P56	N7	P56	RSPI-CLK	R61, R384	R383	U13.6	-	-
			DSMDAT1	R61, R383	R384	J9.10	-	-
P75	R13	P75	ET0-ERXD0_RMII0RXD0	R69	R343	U15.16	-	-
			DSMDAT2	R343	R69	J9.8	-	-
P74	R14	P74	ET0-ERXD1_RMII0RXD1	R92, R90	R96	U15.15	-	-
			DSMCLK2	R96, R90	R92	J9.7	-	-
P72	K15	P72	DSW-CATID4	R345	R344	SW5.12	-	-
			DSMDAT3	R344	R345	J9.6	-	-
DSMCLK3	J13	P71	DSMCLK3	R404	-	J9.5	-	-
P83	M9	P83	DSMCLK1	R57, R387	R388	J9.9	-	-
			JA6-SCKc	R388, R57	R387	JA6.11	-	-

6.10 EtherCAT Configuration

Table 6-13, Table 6-14, Table 6-15 below details the function of the option links associated with EtherCAT Configuration.

Table 6-13: EtherCAT Configuration Option Links(ECAT-IN)

Signal name	MCU		MCU Peripheral Selection			Destination Selection		
	Pin	Port	Signal	Fit	DNF	Interface /Function	Fit	DNF
P34	H2	P34	ET0-LED0	R11	R342, R229	ETHERNET0.11	-	-
			DSMDAT0	R342	R11, R229	U15.30	-	-
			JA2-IRQa-M1HSIN0	R229	R11, R342	J9.12	-	-
P75	R13	P75	ET0-ERXD0_RMII0RXD0	R69	R343	U15.16	-	-
			DSMDAT2	R343	R69	J9.8	-	-
P74	R14	P74	ET0-ERXD1_RMII0RXD1	R92, R90	R96	U15.15	-	-
			DSMCLK2	R96, R90	R92	J9.7	-	-
ET0-ERXD3	F5	PK5	ET0-ERXD3	-	-	U15.13	-	-
ET0-ERXD2	F4	PK4	ET0-ERXD2	-	-	U15.14	-	-
ET0-RXDV	N11	PK2	ET0-RXDV_RMII0CRSDV	R55	R46	U15.18	-	-
ET0-TXEN_RMII0TXDEN	M12	PL6	ET0-TXEN_RMII0TXDEN	-	-	U15.23	-	-
ET0-ETXD1_RMII0TXD1	M11	PL5	ET0-ETXD1_RMII0TXD1	-	-	U15.25	-	-
ET0-ETXD0_RMII0TXD0	R12	PL4	ET0-ETXD0_RMII0TXD0	-	-	U15.24	-	-
ET0-RXCLK	K10	PL3	ET0-RXCLK	R41	-	U15.19	R39	R35
ET0-RXER_RMII0RXER	P12	PL2	ET-ET0RXER_RMII0RXER	-	-	U17.2	R35	R39
ET0-TXCLK	N13	PM6	ET0-TXCLK	R71	-	U15.20	-	-
ET0-ETXD2	P14	PM4	ET0-ETXD2	-	-	U15.22	-	-
ET0-ETXD3	P15	PM3	ET0-ETXD3	-	-	U15.26	-	-
						U15.27	-	-

Table 6-14: EtherCAT Configuration Option Links(ECAT-OUT)

Signal name	MCU		MCU Peripheral Selection			Destination Selection		
	Pin	Port	Signal	Fit	DNF	Interface /Function	Fit	DNF
ET1-LED0	M6	P84	ET1-LED0	-	-	ETHERNET1.11	-	-
						U16.30	-	-
ET1-ERXD3	P15	PM3	ET1-ERXD3	-	-	U16.13	-	-
ET1-ERXD2	K11	PM2	ET1-ERXD2	-	-	U16.14	-	-
ET1-ERXD1_RMII1RXD1	F11	PM1	ET1-ERXD1_RMII1RXD1	-	-	U16.15	-	-
ET1-ERXD0_RMII1RXD0	G11	PM0	ET1-ERXD0_RMII1RXD0	-	-	U16.16	-	-
ET1-RXER_RMII1RXER	H9	PN3	ET-ET1RXER_RMII1RXER	-	-	U16.20	-	-
ET1-TXCLK	G9	PN2	ET1-TXCLK	R56	-	U16.22	-	-
ET1-ETXD3	F8	PN1	ET1-ETXD3	-	-	U16.27	-	-
ET1-ETXD2	E6	PN0	ET1-ETXD2	-	-	U16.26	-	-
ET1-TXEN_RMII1TXDEN	H8	PQ7	ET1-TXEN_RMII1TXDEN	-	-	U16.23	-	-
ET1-ETXD1_RMII1TXD1	F9	PQ6	ET1-ETXD1_RMII1TXD1	-	-	U16.25	-	-
ET1-ETXD0_RMII1TXD0	E10	PQ5	ET1-ETXD0_RMII1TXD0	-	-	U16.24	-	-
ET1-RXCLK	E11	PQ4	ET1-RXCLK	R146	-	U16.19	R109	R103
						U17.6	R103	R109
ET1-RXDV	G8	PQ2	ET1-RXDV_RMII1CRSDV	R123	R115	U16.18	-	-

Table 6-15: EtherCAT Configuration Option Links(ECAT-IN/ECAT-OUT)

Signal name	MCU		MCU Peripheral Selection			Destination Selection		
	P.in	P.out	Signal	Fit	DNF	Interface /Function	Fit	DNF
P15	J7	P15	LED-CATRUN	R10	R221	LED6.A	-	-
			JA2-IRQb-M1HSIN1	R221	R10	JA2.9	-	-
P11	P8	P11	P11	-	-	T9	-	-
			JA6-M1VIN	R95	-	JA6.15	-	-
ET-INTn	L2	P27	ET-INTn	-	-	U15.21 U16.21	-	R94
CAT12C-DATA	P10	P82	CAT12C-DATA	-	-	U4.5	-	-
CLKOUT25M	K1	PH7	CLKOUT25M	R75	-	U15.9 U16.9	R373	R374
PH6	K2	PH6	PH6	-	-	T2	-	-
PH5	K4	PH5	PH5	-	-	T18	-	-
			JA1-IO2	R199	-	JA1.17	-	-
LED-CATSTAT	K3	PH4	LED-CATSTAT	-	-	LED8.3	-	-
LED-CATERR	L1	PH3	LED-CATERR	-	-	LED7.A LED8.1	-	-
CAT12C-CLK	K6	PH1	CAT12C-CLK	-	-	U4.6	-	-
PJ5	G5	PJ5	PJ5	-	-	T18	-	-
			PMOD2-CS	R326	R194	PMOD2.1	-	-
			JA1-IO3	R194	R326	JA1.18	-	-
ET-RESn	H7	PJ3	ET-RESn	-	-	U15.32 U16.32	-	-
LED-CATOUT	P1	PK7	LED-CATOUT	-	-	LED5.A	-	-
LED-CATIN	F7	PK6	LED-CATIN	-	-	LED4.A	-	-
ET-MDC	M10	PK0	ET-MDC	-	-	U15.12	-	-
						U16.12	-	-
ET-MDIO	L10	PL7	ET-MDIO	-	-	U15.11	-	-
						U16.11	-	-

6.11 Ethernet Configuration

Table 6-16, Table 6-17, Table 6-18 below details the function of the option links associated with Ethernet Configuration.

Table 6-16: Ethernet Configuration Option Links(ECAT-IN)

Signal name	MCU		MCU Peripheral Selection			Destination Selection		
	Pin	Port	Signal	Fit	DNF	Interface /Function	Fit	DNF
P34	H2	P34	ET0-LED0	R11	R342, R229	ETHERNET0.11	-	-
			DSMDAT0	R342	R11, R229	U15.30	-	-
			JA2-IRQa-M1HSIN0	R229	R11, R342	J9.12	-	-
P75	R13	P75	ET0-ERXD0_RMII0RXD0	R69	R343	U15.16	-	-
			DSMDAT2	R343	R69	J9.8	-	-
P74	R14	P74	ET0-ERXD1_RMII0RXD1	R92, R90	R96	U15.15	-	-
			DSMCLK2	R96, R90	R92	J9.7	-	-
ET0-ERXD3	F5	PK5	ET0-ERXD3	-	-	U15.13	-	-
ET0-ERXD2	F4	PK4	ET0-ERXD2	-	-	U15.14	-	-
ET0-RXDV	N11	PK2	ET0-RXDV_RMII0CRSDV	R55	R46	U15.18	-	-
ET0-COL	K9	PK1	ET0-COL	-	-	U15.28	-	-
ET0-TXEN_RMII0TXDEN	M12	PL6	ET0-TXEN_RMII0TXDEN	-	-	U15.23	-	-
ET0-ETXD1_RMII0TXD1	M11	PL5	ET0-ETXD1_RMII0TXD1	-	-	U15.25	-	-
ET0-ETXD0_RMII0TXD0	R12	PL4	ET0-ETXD0_RMII0TXD0	-	-	U15.24	-	-
ET0-RXCLK	K10	PL3	ET0-RXCLK	R41	-	U15.19	R39	R35
						U17.2	R35	R39
ET0-RXER_RMII0RXER	P12	PL2	ET-ET0RXER_RMII0RXER	-	-	U15.20	-	-
PM7	M13	PM7	ET0-RXDV_RMII0CRSDV	R46	R55, R377	U15.18	-	-
			ET0-CRS	R377, R55	R46	U15.29	-	-
ET0-TXCLK	N13	PM6	ET0-TXCLK	R71	-	U15.22	-	-
ET0-ETXD2	P14	PM4	ET0-ETXD2	-	-	U15.26	-	-
ET0-ETXD3	P15	PM3	ET0-ETXD3	-	-	U15.27	-	-

Table 6-17: Ethernet Configuration Option Links(ECAT-OUT)

Signal name	MCU		MCU Peripheral Selection			Destination Selection		
	Pin	Port	Signal	Fit	DNF	Interface /Function	Fit	DNF
ET1-LED0	M6	P84	ET1-LED0	-	-	ETHERNET1.11	-	-
						U16.30	-	-
ET1-ERXD3	P15	PM3	ET1-ERXD3	-	-	U16.13	-	-
ET1-ERXD2	K11	PM2	ET1-ERXD2	-	-	U16.14	-	-
ET1-ERXD1_RMII1RXD1	F11	PM1	ET1-ERXD1_RMII1RXD1	-	-	U16.15	-	-
ET1-ERXD0_RMII1RXD0	G11	PM0	ET1-ERXD0_RMII1RXD0	-	-	U16.16	-	-
ET1-RXER_RMII1RXER	H9	PN3	ET-ET1RXER_RMII1RXER	-	-	U16.20	-	-
ET1-TXCLK	G9	PN2	ET1-TXCLK	R56	-	U16.22	-	-
ET1-ETXD3	F8	PN1	ET1-ETXD3	-	-	U16.27	-	-
ET1-ETXD2	E6	PN0	ET1-ETXD2	-	-	U16.26	-	-
ET1-TXEN_RMII1TXDEN	H8	PQ7	ET1-TXEN_RMII1TXDEN	-	-	U16.23	-	-
ET1-ETXD1_RMII1TXD1	F9	PQ6	ET1-ETXD1_RMII1TXD1	-	-	U16.25	-	-
ET1-ETXD0_RMII1TXD0	E10	PQ5	ET1-ETXD0_RMII1TXD0	-	-	U16.24	-	-
ET1-RXCLK	E11	PQ4	ET1-RXCLK	R146	-	U16.19	R109	R103
						U17.6	R103	R109
ET1-RXDV	G8	PQ2	ET1-RXDV_RMII1CRSDV	R123	R115	U16.18	-	-
ET1-COL	E8	PQ1	ET1-COL	-	-	U16.28	-	-
PQ0	E7	PQ0	ET1-RXDV_RMII1CRSDV	R115	R401, R123	U16.18	-	-
			ET1-CRS	R401, R123	R115	U16.29	-	-

Table 6-18: Ethernet Configuration Option Links(ECAT-OUT)

Signal name	MCU		MCU Peripheral Selection			Destination Selection		
	Pin	Port	Signal	Fit	DNF	Interface /Function	Fit	DNF
P11	P8	P11	P11	-	-	T9	-	-
			JA6-M1VIN	R95	-	JA6.15	-	-
P31	J4	P31	ET-INTn	R94	R215	U15.21	-	-
			JA2-CTSaRTSa	R215	R94	U16.21	-	-
CLKOUT25M	K1	PH7	CLKOUT25M	R75	-	U15.9	R373	R374
						U16.9		
PJ5	G5	PJ5	PJ5	-	-	T18	-	-
			PMOD2-CS	R326	R194	PMOD2.1	-	-
			JA1-IO3	R194	R326	JA1.18	-	-
ET-RESn	H7	PJ3	ET-RESn	-	-	U15.32	-	-
						U16.32	-	-
ET-MDC	M10	PK0	ET-MDC	-	-	U15.12	-	-
						U16.12	-	-
ET-MDIO	L10	PL7	ET-MDIO	-	-	U15.11	-	-
						U16.11	-	-

Table 6-19 below details the function of the jumpers associated with the Ethernet Configuration.

Table 6-19: Ethernet Configuration Option Links(PHY Mode)

PHY Mode	Mount Position	Reference	Related Links.
MII Mode	DNF	R35, R374, R103, R13, R78, R46, R115	U15, U16, U17
	Fit	R9, R39, R373, R109, R55, R377, R123, R401	
RMII Mode	Fit	R35, R374, R103, R13, R78, R46, R115	U15, U16, U17
	DNF	R9, R39, R373, R109, R55, R377, R123, R401	

6.12 General IO & LED Configuration

Table 6-20 below details the function of the option links associated with General IO & LED Configuration.

Table 6-20: General IO & LED Configuration Option Links

Signal name	MCU		MCU Peripheral Selection			Destination Selection		
	Pin	Port	Signal	Fit	DNF	Interface /Function	Fit	DNF
P01	D5	P01	SERIAL-RXD	R253	R189	U12.3	-	R126, R129
			JA1-IO5	R189	R253	JA1.20	-	-
P10	K7	P10	JA3-ALE	R245	R184, R91	JA3.46	R295	R296
			JA1-IO6	R184	R245, R91	JA1.21	-	-
			JA6-M1WIN	R91	R245, R184	JA6.16	-	-
P15	J7	P15	LED-CATRUN	R10	R221	LED6.A	-	-
			JA2-IRQb-M1HSIN1	R221	R10	JA2.9	-	-
P34	H2	P34	ET0-LED0	R11	R342, R229	ETHERNET0.11	-	-
			DSMDAT0	R342	R11, R229	U15.30	-	-
			JA2-IRQa-M1HSIN0	R229	R11, R342	JA2.7	-	-
P42	B3	P42	LED0	R416	R415	LED0.K	R358	-
			JA1-ADC2	R415	R416	JA1.11	-	-
LED3	N4	P85	LED3	-	-	LED3.K	R358	-
ET1-LED0	M6	P84	ET1-LED0	-	-	ETHERNET1.11	-	-
						U16.30	-	-
PF5	G6	PF5	SDHI-PE	R314	R261, R191	U8.4	-	-
			JA3-WAIT	R261	R314, R191	JA3.45	R260	R294
			JA1-IO4	R191	R314, R261	JA1.19	-	-
PH5	K4	PH5	PH5	-	-	T18	-	-
			JA1-IO2	R199	-	JA1.17	-	-
LED-CATSTAT	K3	PH4	LED-CATSTAT	-	-	LED8.3	-	-
LED-CATERR	L1	PH3	LED-CATERR	-	-	LED7.A	-	-
						LED8.1	-	-
LED1	N2	PH0	LED1	-	-	LED1.K	R358	-
PJ5	G5	PJ5	PJ5	-	-	T18	-	-
			PMOD2-CS	R326	R194	PMOD2.1	-	-
			JA1-IO3	R194	R326	JA1.18	-	-
LED-CATOUT	P1	PK7	LED-CATOUT	-	-	LED4.A	-	-
LED-CATIN	F7	PK6	LED-CATIN	-	-	LED5.A	-	-
PK3	J9	PK3	DSW-PROFINET1	R222	R206	SW4.4	-	-
			JA1-IO1	R206	R222	JA1.16	-	-
PL0	H11	PL0	RS485-DE	R157	R180	U9.3	-	-
			JA1-IO7	R180	R157	JA1.22	-	-
PN5	J11	PN5	DSW-CATID7	R204	R212	SW5.9	-	-
			JA1-IO0	R212	R204	JA1.15	-	-
LED2	L12	PN4	LED2	-	-	LED2.K	R358	-

6.13 I2C & EEPROM Configuration

Table 6-21 and Table 6-22 below detail the function of the option links associated with I2C & EEPROM Configuration.

Table 6-21: I2C & EEPROM Configuration Option Links (1)

Signal name	MCU		MCU Peripheral Selection			Destination Selection		
	Pin	Port	Signal	Fit	DNF	Interface /Function	Fit	DNF
P13	N5	P13	E2P-SDA	R266, R162	-	U3.5	-	-
			JA1-SDA			JA1.25	-	-
P12	R4	P12	E2P-SCL	R395, R393	R394	U3.6	-	-
			JA1-SCL			JA1.26	-	-
			JA6-M1UIN	R394	R395, R393	JA6.14	-	-
CATI2C-DATA	P10	P82	CATI2C-DATA	-	-	U4.5	-	-
CATI2C-CLK	K6	PH1	CATI2C-CLK	-	-	U4.6	-	-

Table 6-22: I2C & EEPROM Configuration Option Links (2)

Reference	Configuration	Fit	DNF	Related Links.
SDA0[FM+], SCL0[FM+]	Connect pull-up resistor to Board_3V3.	R271	R270	U3
	Connect pull-up resistor to Board_5V.	R270	R271	U3
WP	EEPROM Write protect.	R238	-	U3
A0, A1, A2	Device address (0xA6).	R251, R252, R226	R225, R227, R228	U3
	Device address (0xA4).	R251, R228, R226	R225, R227, R252	U3
WP	For EtherCAT EEPROM Write protect.	R195	-	U4

6.14 IRQ & Switch Configuration

Table 6-23 and Table 6-24 below details the function of the option links associated with IRQ & Switch Configuration.

Table 6-23: IRQ & Switch Configuration Option Links (1)

Signal name	MCU		MCU Peripheral Selection			Destination Selection		
	Pin	Port	Signal	Fit	DNF	Interface /Function	Fit	DNF
P07 ^{*1}	E5	P07	SW3	R470	R236, R174	SW3	-	-
			JA1-ADTRG	R236	R470, R174	JA1.8	-	-
			JA1-IRQd	R174	R470, R236	JA1.23	-	-
P05	C3	P05	DSW-CATID3	R201	R214	SW5.13	-	-
			JA1-DAC1	R214	R201	JA1.14	-	-
P03	D3	P03	SERIAL-CTS	R275	R218	U12.2	-	-
			JA1-DAC0	R218	R275	JA1.13	-	-
PMOD1-IO1	D6	P02	PMOD1-IO1	-	-	PMOD1.8	-	-
P00	E3	P00	SERIAL-TXD	R233	R323	U11.3	-	R312, R137
			PMOD2-IO1	R323	R233	PMOD2.8	-	-
P15	J7	P15	LED-CATRUN	R10	R221	LED6.A	-	-
			JA2-IRQb-M1HSIN1	R221	R10	JA2.9	-	-
ET-INTn	L2	P27	ET-INTn	-	-	U15.21	-	R94
						U16.21		
P35	H3	P35	JP-UPSEL	-	-	J14.2	-	-
			JA2-NMIn	R240	-	JA2.3	-	-
P34	H2	P34	ET0-LED0	R11	R342, R229	ETHERNET0.11	-	-
			DSMDAT0	R342	R11, R229	U15.30	-	-
			JA2-IRQA-M1HSIN0	R229	R11, R342	JA2.7	-	-
P32	H5	P32	CAN1TX	R216	R125, R128	U19.3	-	-
			JA2-IRQc_M1HSIN2	R125	R216, R128	JA2.23	R177	R164
			JA5-CAN1TX	R128	R216, R125	JA5.5	-	-

*1: When changing the option link of P07, pay attention to the presence or absence of a pull-up resistor. Leave the pull-up resistor for SW3 (R467) fitted, otherwise the internal pull-up in the MCU will need to be enabled.

Table 6-24: IRQ & Switch Configuration Option Links (2)

Signal name	MCU		MCU Peripheral Selection			Destination Selection		
	P _{in}	Port	Signal	Fit	DNF	Interface /Function	Fit	DNF
P31	J4	P31	ET-INTn	R94	R215	U15.21	-	-
			JA2-CTSaRTSa	R215	R94	U16.21	-	-
P30	J5	P30	PMOD1-IO0	R376	R193, R183	PMOD1.7	-	-
			JA2-M1WP	R193	R376, R183	JA2.17	-	-
			JA2-TIMIN0	R183	R376, R193	JA2.21	-	-
P47	D2	P47	DSW-CATID5	R202	R306	SW5.11	-	-
			PMOD2-IO3	R306	R202	PMOD2.10	-	-
P46	B4	P46	DSW-CATID1	R200	R330	SW5.15	-	-
			PMOD2-IO0	R330	R200	PMOD2.7	-	-
SW1	D1	P45	SW1	-	-	SW1	-	-
SW2	C4	P44	SW2	-	-	SW2	-	-
P41	A4	P41	SDHI-POWFLT	R310	R230	U8.5	-	-
			JA1-ADC1	R230	R310	JA1.10	-	-
DSW-PROFINET0	C10	P60	DSW-PROFINET0	-	-	SW4.3	-	-
P72	K15	P72	DSW-CATID4	R345	R344	SW5.12	-	-
			DSMDAT3	R344	R345	J9.6	-	-
PC7	N9	PC7	RS485-TXD	J12 (1-2pin short)	R166, R156	U9.4	-	-
			EMU-UB	J12	R166, R156	E1.10	-	-
			DSW-UB	J12 (2-3pin short)	R166, R156	SW4.2	-	-
			JA2-M1TRDCLK	R166	J12 (open) , R156	JA2.26	-	-
JA6-TXDc	R156	J12 (open) , R166	JA6.9	-	-			
DSW-CATID0	J6	PH2	DSW-CATID0	-	-	SW5.16	-	-
PK3	J9	PK3	DSW-PROFINET1	R222	R206	SW4.4	-	-
			JA1-IO1	R206	R222	JA1.16	-	-
PQ3	E9	PQ3	DSW-CATID2	R309	R316	SW5.14	-	-
			PMOD2-IO2	R316	R309	PMOD2.9	-	-
MD_FINED	G4	-	EMU-MD_FINED	-	-	E1.7	-	-
			DSW-MD_FINED	-	-	SW4.1	-	-
RESn	G7	-	EMU-RESn	-	-	E1.13	-	-
			SW-RESn	-	-	RES1(Switch)	-	-
			JA2-RESn	-	-	JA2.1	-	-

6.15 MTU & POE Configuration

Table 6-25 and Table 6-26 below details the function of the option links associated with MTU & POE Configuration.

Table 6-25: MTU & POE Configuration Option Links (1)

Signal name	MCU		MCU Peripheral Selection			Destination Selection		
	P _{in}	Port	Signal	Fit	DNF	Interface /Function	Fit	DNF
P16	R3	P16	USB0-VBUS	J10(1-2 short), J7(1-2 short) or R26	R38	USB0_2.1	J8(1-2 short), R24	-
			USB0-VBUSEN	J10(2-3 short)	R38	U7.4	-	-
			JA2-M1UD	R38	J10(Open)	JA2.11	-	-
P15	J7	P15	LED-CATRUN	R10	R221	LED6.A	-	-
			JA2-IRQb-M1HSIN1	R221	R10	JA2.9	-	-
P14	P4	P14	USB0-OVRCURA	R64	R63	U7.5	-	-
			JA2-M1TRCCLK	R63	R64	JA2.25	-	-
P12	R4	P12	E2P-SCL	R395, R393	R394	U3.6	-	-
			JA1-SCL			JA1.26	-	-
			JA6-M1UIN	R394	R395, R393	JA6.14	-	-

Table 6-26: MTU & POE Configuration Option Links (2)

Signal name	MCU		MCU Peripheral Selection			Destination Selection		
	Pin	Port	Signal	Fit	DNF	Interface /Function	Fit	DNF
P11	P8	P11	P11	-	-	T9	-	-
			JA6-M1VIN	R95	-	JA6.15	-	-
P10	K7	P10	JA3-ALE	R245	R184, R91	JA3.46	R295	R296
			JA1-IO6	R184	R245, R91	JA1.21	-	-
			JA6-M1WIN	R91	R245, R184	JA6.16	-	-
P25	M3	P25	SDHI-CD	R400	R198, R188, R124	SDHI1.10	-	-
			JA2-M1VN	R198	R400, R188, R124	JA2.16	-	-
			JA2-TIMOUT1	R188	R400, R198, R124	JA2.20	-	-
			JA6-RXD _b	R124	R400, R198, R188	JA6.7	-	-
P24	L4	P24	SDHI-WP	R399, R390	R382, R380, R381	SDHI1.12	-	-
			JA2-M1VP	R399, R382	R390, R380, R381	JA2.15	-	-
			JA6-SCK _b	R399, R380	R390, R382, R381	JA6.10	-	-
			JA2-TIMOUT0	R399, R381	R390, R382, R380	JA2.19	-	-
P22	N1	P22	SDHI-D0	R455	R208, R145	SDHI1.7	-	-
			JA2-M1UP	R208	R455, R145	JA2.13	-	-
			JA6-DREQ	R145	R455, R208	JA6.1	-	-
P20	P3	P20	SDHI-CMD	R464	R165	SDHI1.2	-	-
			JA2-M1ENC	R165	R464	JA2.23	R164	R177
P34	H2	P34	ET0-LED0	R11	R342, R229	ETHERNET0.11 U15.30	-	-
			DSMDAT0	R342	R11, R229	J9.12	-	-
			JA2-IRQa-M1HSIN0	R229	R11, R342	JA2.7	-	-
P32	H5	P32	CAN1TX	R216	R125, R128	U19.3	-	-
			JA2-IRQc_M1HSIN2	R125	R216, R128	JA2.23	R177	R164
			JA5-CAN1TX	R128	R216, R125	JA5.5	-	-
P30	J5	P30	PMOD1-IO0	R376	R193, R183	PMOD1.7	-	-
			JA2-M1WP	R193	R376, R183	JA2.17	-	-
			JA2-TIMIN0	R183	R376, R193	JA2.21	-	-
P86	N3	P86	RS485-RXD	R102	R105, R192, R182	U18.3	-	-
			JA6-RXD _c	R105	R102, R192, R182	JA6.12	-	-
			JA2-M1WN	R192	R102, R105, R182	JA2.18	-	-
			JA2-TIMIN1	R182	R102, R105, R192	JA2.22	-	-
P81	L9	P81	QSPI-IO3	R175	R207	U14.7	-	-
			JA2-M1UN	R207	R175	JA2.14	-	-
PC7	N9	PC7	RS485-TXD	J12 (1-2pin short)	R166, R156	U9.4	-	-
			EMU-UB	J12	R166, R156	E1.10	-	-
			DSW-UB	(2-3pin short)		SW4.2	-	-
			JA2-M1TRDCLK	R166	J12 (open) , R156	JA2.26	-	-
JA6-TXD _c	R156	J12 (open) , R166	JA6.9	-	-			
PC4	P11	PC4	QSPI-IO1	R217, R88	R290, R155	U14.2	-	-
			JA3-A20	R290, R88	R217, R155	JA3.41	-	-
			JA2-M1POE	R155, R88	R217, R290	JA2.24	-	-
PC1	N14	PC1	JA3-A17	R288	R98, R203	JA3.38	-	-
			DSW-CATID6	R203	R288, R98	SW5.10	-	-
			JA6-M1TOGGLE	R98	R288, R203	JA6.13	-	-

6.16 PMOD1 Configuration

Table 6-27 below details the function of the option links associated with PMOD1 Configuration.

Table 6-27: PMOD1 Configuration Option Links

Signal name	MCU		MCU Peripheral Selection			Destination Selection		
	Pin	Port	Signal	Fit	DNF	Interface /Function	Fit	DNF
PMOD1-IO1	D6	P02	PMOD1-IO1	-	-	PMOD1.8	-	-
P30	J5	P30	PMOD1-IO0	R376	R193, R183	PMOD1.7	-	-
			JA2-M1WP	R193	R376, R183	JA2.17	-	-
			JA2-TIMIN0	R183	R376, R193	JA2.21	-	-
PC6	R9	PC6	JA3-A22	R292	R364	JA3.43	-	-
			PMOD1-MISO	R364	R292	PMOD1.3	-	-
PC5	R10	PC5	JA3-A21	R291	R375	JA3.42	-	-
			PMOD1-CS	R375	R291	PMOD1.1	-	-
PMOD1-MOSI	L6	PJ2	PMOD1-MOSI	-	-	PMOD1.2	-	-
PMOD1-IO2	N6	PJ1	PMOD1-IO2	-	-	PMOD1.9	-	-
PMOD1-SCK	M5	PJ0	PMOD1-SCK	R62	-	PMOD1.4	-	-
PMOD1-IO3	J10	PL1	PMOD1-IO3	-	-	PMOD1.10	-	-

6.17 PMOD2 Configuration

Table 6-28 below details the function of the option links associated with PMOD2 Configuration.

Table 6-28: PMOD2 Configuration Option Links

Signal name	MCU		MCU Peripheral Selection			Destination Selection		
	Pin	Port	Signal	Fit	DNF	Interface /Function	Fit	DNF
P00	E3	P00	SERIAL-TXD	R233	R323	U11.3	-	R312, R137
			PMOD2-IO1	R323	R233	PMOD2.8	-	-
P47	D2	P47	DSW-CATID5	R202	R306	SW5.11	-	-
			PMOD2-IO3	R306	R202	PMOD2.10	-	-
P46	B4	P46	DSW-CATID1	R200	R330	SW5.15	-	-
			PMOD2-IO0	R330	R200	PMOD2.7	-	-
P52	L8	P52	JA3-RDn	R279	R308	JA3.25	-	-
			PMOD2-MISO	R308	R279	PMOD2.3	-	-
P51	M8	P51	JA3-WRHn	R385	R386	JA3.47	R298	R299
			PMOD2-SCK	R386	R385	PMOD2.4	-	-
P50	K8	P50	JA3-WRn	R283	R263, R319	JA3.26	R282	R281
			JA3-WRLn	R263	R283, R319	JA3.48	R297	R151
			PMOD2-MOSI	R319	R283, R263	PMOD2.2	-	-
PJ5	G5	PJ5	PJ5	-	-	T18	-	-
			PMOD2-CS	R326	R194	PMOD2.1	-	-
			JA1-IO3	R194	R326	JA1.18	-	-
PQ3	E9	PQ3	DSW-CATID2	R309	R316	SW5.14	-	-
			PMOD2-IO2	R316	R309	PMOD2.9	-	-

6.18 QSPI Configuration

Table 6-29 below details the function of the option links associated with QSPI Configuration.

Table 6-29: QSPI Configuration Option Links

Signal name	MCU		MCU Peripheral Selection			Destination Selection		
	Pin	Port	Signal	Fit	DNF	Interface /Function	Fit	DNF
QSPI-CLK	L11	P77	QSPI-CLK	R58	-	U14.6	-	-
QSPI-CS	N12	P76	QSPI-CS	-	-	U14.1	-	-
P81	L9	P81	QSPI-IO3	R175	R207	U14.7	-	-
			JA2-M1UN	R207	R175	JA2.14	-	-
QSPI-IO2	N10	P80	QSPI-IO2	-	-	U14.3	-	-
PC4	P11	PC4	QSPI-IO1	R217, R88	R290, R155	U14.2	-	-
			JA3-A20	R290, R88	R217, R155	JA3.41	-	-
			JA2-M1POE	R155, R88	R217, R290	JA2.24	-	-
PC3	R11	PC3	QSPI-IO0	R422	R289	U14.5	-	-
			JA3-A19	R289	R422	JA3.40	-	-

6.19 RS-485 Configuration

Table 6-30 below details the function of the option links associated with RS-485 Configuration.

Table 6-30: RS-485 Configuration Option Links

Signal name	MCU		MCU Peripheral Selection			Destination Selection		
	Pin	Port	Signal	Fit	DNF	Interface /Function	Fit	DNF
P86	N3	P86	RS485-RXD	R102	R105, R192, R182	U18.3	-	-
			JA6-RXDc	R105	R102, R192, R182	JA6.12	-	-
			JA2-M1WN	R192	R102, R105, R182	JA2.18	-	-
			JA2-TIMIN1	R182	R102, R105, R192	JA2.22	-	-
PC7	N9	PC7	RS485-TXD	J12 (1-2pin short)	R166, R156	U9.4	-	-
			EMU-UB	J12	R166, R156	E1.10	-	-
			DSW-UB	(2-3pin short)		SW4.2	-	-
			JA2-M1TRDCLK	R166	J12 (open), R156	JA2.26	-	-
PL0	H11	PL0	RS485-DE	R157	R180	U9.3	-	-
			JA1-IO7	R180	R157	JA1.22	-	-

6.20 RSPI Configuration

Table 6-31 below details the function of the option links associated with RSPI Configuration.

Table 6-31: RSPI Configuration Option Links

Signal name	MCU		MCU Peripheral Selection			Destination Selection		
	Pin	Port	Signal	Fit	DNF	Interface /Function	Fit	DNF
RSPI-CS	P7	P57	RSPI-CS	-	-	U13.1	-	-
P56	N7	P56	RSPI-CLK	R61, R384	R383	U13.6	-	-
			DSMDAT1	R61, R383	R384	J9.10	-	-
RSPI-MISO	R8	P55	RSPI-MISO	-	-	U13.2	-	-
RSPI-MOSI	R7	P54	RSPI-MOSI	-	-	U13.5	-	-

6.21 Serial & USB to Serial Configuration

Table 6-32 below details the function of the option links associated with Serial & USB to Serial Configuration.

Table 6-32: Serial & USB to Serial Configuration Option Links

Signal name	MCU		MCU Peripheral Selection			Destination Selection		
	Pin	Port	Signal	Fit	DNF	Interface /Function	Fit	DNF
P03	D3	P03	SERIAL-CTS	R275	R218	U12.2	-	-
			JA1-DAC0	R218	R275	JA1.13	-	-
P01	D5	P01	SERIAL-RXD	R253	R189	U12.3	-	R126, R129
			JA1-IO5	R189	R253	JA1.20	-	-
P00	E3	P00	SERIAL-TXD	R233	R323	U11.3	-	R312, R137
			PMOD2-IO1	R323	R233	PMOD2.8	-	-
P17	P2	P17	SDHI-D3	R462	R116	SDHI1.1	-	-
			JA6-TXDb	R116	R462	JA6.8	-	-
P25	M3	P25	SDHI-CD	R400	R198, R188, R124	SDHI1.10	-	-
			JA2-M1VN	R198	R400, R188, R124	JA2.16	-	-
			JA2-TIMOUT1	R188	R400, R198, R124	JA2.20	-	-
			JA6-RXDb	R124	R400, R198, R188	JA6.7	-	-
P31	J4	P31	ET-INTn	R94	R215	U15.21	-	-
			JA2-CTSaRTSa	R215	R94	U16.21	-	-
P43	E4	P43	SERIAL-RTS	R414	R413	U11.2	-	-
			JA1-ADC3	R413	R414	JA1.12	-	-
P86	N3	P86	RS485-RXD	R102	R105, R192, R182	U18.3	-	-
			JA6-RXDc	R105	R102, R192, R182	JA6.12	-	-
			JA2-M1WN	R192	R102, R105, R182	JA2.18	-	-
			JA2-TIMIN1	R182	R102, R105, R192	JA2.22	-	-
P83	M9	P83	DSMCLK1	R57, R387	R388	J9.9	-	-
			JA6-SCKc	R388, R57	R387	JA6.11	-	-
PC7	N9	PC7	RS485-TXD	J12 (1-2pin short)	R166, R156	U9.4	-	-
			EMU-UB	J12	R166, R156	E1.10	-	-
			DSW-UB	(2-3pin short)		SW4.2	-	-
			JA2-M1TRDCLK	R166	J12 (open), R156	JA2.26	-	-
PF2	J2	PF2	JA6-TXDc	R156	J12 (open), R166	JA6.9	-	-
			EMU-TDI_RXD	R300	R126, R234	E1.11	-	-
PF2	J2	PF2	SERIAL-RXD	R126	R300, R234	U12.3	-	R129, R253
			JA2-RXDc	R234	R300, R126	JA2.8	-	-
			JA2-RXDd	R234	R300, R126	JA2.8	-	-
PF1	L3	PF1	EMU-TCK	R397, R398	R396	E1.1	-	-
			JA2-SCKa	R396, R398	R397	JA2.10	-	-
PF0	K5	PF0	EMU-TDO_TXD	R318	R312, R235	E1.5	-	-
			SERIAL-TXD	R312	R318, R235	U11.3	-	R137, R233
			JA2-TXDd	R235	R318, R312	JA2.6	-	-

6.22 SDHI Configuration

Table 6-33 below details the function of the option links associated with SDHI Configuration.

Table 6-33: SDHI Configuration Option Links

Signal name	MCU		MCU Peripheral Selection			Destination Selection		
	Pin	Port	Signal	Fit	DNF	Interface /Function	Fit	DNF
P17	P2	P17	SDHI-D3	R462	R116	SDHI1.1	-	-
			JA6-TXDb	R116	R462	JA6.8	-	-
P25	M3	P25	SDHI-CD	R400	R198, R188, R124	SDHI1.10	-	-
			JA2-M1VN	R198	R400, R188, R124	JA2.16	-	-
			JA2-TIMOUT1	R188	R400, R198, R124	JA2.20	-	-
			JA6-RXDb	R124	R400, R198, R188	JA6.7	-	-
P24	L4	P24	SDHI-WP	R399, R390	R382, R380, R381	SDHI1.12	-	-
			JA2-M1VP	R399, R382	R390, R380, R381	JA2.15	-	-
			JA6-SCKb	R399, R380	R390, R382, R381	JA6.10	-	-
			JA2-TIMOUT0	R399, R381	R390, R382, R380	JA2.19	-	-
P23	M2	P23	SDHI-D1	R463	R139	SDHI1.8	-	-
			JA6-DACK	R139	R463	JA6.2	-	-
P22	N1	P22	SDHI-D0	R455	R208, R145	SDHI1.7	-	-
			JA2-M1UP	R208	R455, R145	JA2.13	-	-
			JA6-DREQ	R145	R455, R208	JA6.1	-	-
SDHI-CLK	R1	P21	SDHI-CLK	R74	-	SDHI1.5	-	-
P20	P3	P20	SDHI-CMD	R464	R165	SDHI1.2	-	-
			JA2-M1ENC	R165	R464	JA2.23	R164	R177
P41	A4	P41	SDHI-POWFLT	R310	R230	U8.5	-	-
			JA1-ADC1	R230	R310	JA1.10	-	-
SDHI-D2	R2	P87	SDHI-D2	-	-	SDHI1.9	-	-
PF5	G6	PF5	SDHI-PE	R314	R261, R191	U8.4	-	-
			JA3-WAIT	R261	R314, R191	JA3.45	R260	R294
			JA1-IO4	R191	R314, R261	JA1.19	-	-

6.23 USB Configuration

Table 6-34 below details the function of the option links associated with the USB Configuration.

Table 6-34: USB Configuration Option Links

Signal name	MCU		MCU Peripheral Selection			Destination Selection		
	Pin	Port	Signal	Fit	DNF	Interface /Function	Fit	DNF
P16	R3	P16	USB0-VBUS	J10(1-2 short), J7(1-2 short) or R26	R38	USB0_2.1	J8(1-2 short), R24	-
			USB0-VBUSEN	J10(2-3 short)	R38	U7.4	-	-
			JA2-M1UD	R38	J10(Open)	JA2.11	-	-
P14	P4	P14	USB0-OVRCURA	R64	R63	U7.5	-	-
			JA2-M1TRCCLK	R63	R64	JA2.25	-	-
P35	H3	P35	JP-UPSEL	-	-	J14.2	-	-
			JA2-NMin	R240	-	JA2.3	-	-
USB0-DP	R6	-	USB0-DP	-	-	USB0_1.3	-	-
						USB0_2.3	-	-
USB0-DN	R5	-	USB0-DN	-	-	USB0_1.2	-	-
						USB0_2.2	-	-

Table 6-35 below details the function of the jumpers associated with the USB Configuration.

Table 6-35: USB Configuration Jumper Option Links

Reference	Jumper Position	Configuration	Related Links.
J7(DNF) *1	Shorted Pin1-2	Self-powered	J8, R26
	Shorted Pin2-3	Bus-powered	J8, J16, R26
	All open	Self-powered by R26	J8
J8	Shorted Pin1-2	USB0 Function mode	J7, R26
	Shorted Pin2-3	USB0 Host mode	-
	All open	DO NOT SET.	-

*1: If J7 is fitted, remove R26.

When using USB in function mode, be sure to set J8 to 1-2 Short. Also, do not plug in both USB0_1 and USB0_2 cables at the same time.

7. Headers

7.1 Application Headers

This RSK+ board is fitted with application headers, which can be used to connect compatible Renesas application devices or as easy access to MCU pins.

Table 7-1 below lists the connections of the application header, JA1.

Table 7-1: Application Header JA1 Connections

Application Header JA1					
Pin	Header Name	MCU Pin	Pin	Header Name	MCU Pin
	Circuit Net Name			Circuit Net Name	
1	5V	-	2	0V	-
	JA1-5V			GROUND	
3	3V3	-	4	0V	-
	JA1-3V3			GROUND	
5	AVCC	B2, C2	6	AVSS	B1, C1, A3
	JA1-AVCC			JA1-AVSS	
7	AVREF	A2	8	ADTRG	E5
	JA1-VREFH			JA1-ADTRG	
9	ADC0	D4	10	ADC1	A4
	JA1-ADC0			JA1-ADC1	
11	ADC2	B3	12	ADC3	E4
	JA1-ADC2			JA1-ADC3	
13	DAC0	D3	14	DAC1	C3
	JA1-DAC0			JA1-DAC1	
15	IO_0	J11	16	IO_1	J9
	JA1-IO0			JA1-IO1	
17	IO_2	K4	18	IO_3	G5
	JA1-IO2			JA1-IO3	
19	IO_4	G6	20	IO_5	D5
	JA1-IO4			JA1-IO5	
21	IO_6	K7	22	IO_7	H11
	JA1-IO6			JA1-IO7	
23	IRQd / IRQAEC / M2_H SIN0	E5 / NC / NC	24	IIC_EX	NC
	JA1-IRQd			NC	
25	IIC_SDA	N5	26	IIC_SCL	R4
	JA1-SDA			JA1-SCL	

Table 7-2 below lists the connections of the application header, JA2.

Table 7-2: Application Header JA2 Connections

Application Header JA2					
Pin	Header Name	MCU Pin	Pin	Header Name	MCU Pin
	Circuit Net Name			Circuit Net Name	
1	RESET	G7	2	EXTAL	J1
	JA2-RESn			JA2-EXTAL	
3	NMI	H3	4	Vss1	-
	JA2-NMIIn			GROUND	
5	WDT_OVF	NC	6	SClaTX	K5
	NC			JA2-TXD _a	
7	IRQ _a / WKUP / M1_H _{SIN0}	H2	8	SClaRX	J2
	JA2-IRQ _a _M1HSIN0			JA2-RXD _a	
9	IRQ _b / M1_H _{SIN1}	J7	10	SClaCK	L3
	JA2-IRQ _b _M1HSIN1			JA2-SCK _a	
11	M1_UD	R3	12	CTS _a RTS _a	J4
	JA2-M1UD			JA2-CTS _a RTS _a	
13	M1_UP	N1	14	M1_UN	L9
	JA2-M1UP			JA2-M1UN	
15	M1_V _P	L4	16	M1_V _N	M3
	JA2-M1VP			JA2-M1VN	
17	M1_W _P	J5	18	M1_W _N	N3
	JA2-M1WP			JA2-M1WN	
19	TimerOut0	L4	20	TimerOut1	M3
	JA2-TIMOUT0			JA2-TIMOUT1	
21	TimerIn0	J5	22	TimerIn1	N3
	JA2-TIMIN0			JA2-TIMIN1	
23	IRQ _c / M1_EncZ / M1_H _{SIN2}	H5 / P3 / H5	24	M1_POE	P11
	JA2-23PIN			JA2-M1POE	
25	M1_TRCCLK	P4	26	M1_TRDCLK	N9
	JA2-M1TRCCLK			JA2-M1TRDCLK	

Table 7-3 below lists the connections of the BUS application header, JA3.

Table 7-3: Application Header JA3 Connections

Application Header JA3 (Bus)					
Pin	Header Name Circuit Net Name	MCU Pin	Pin	Header Name Circuit Net Name	MCU Pin
1	A0	F12	2	A1	G12
	JA3-A0			JA3-A1	
3	A2	G13	4	A3	G14
	JA3-A2			JA3-A3	
5	A4	G15	6	A5	H15
	JA3-A4			JA3-A5	
7	A6	H14	8	A7	J15
	JA3-A6			JA3-A7	
9	A8	J14	10	A9	J12
	JA3-A8			JA3-A9	
11	A10	L14	12	A11	K14
	JA3-A10			JA3-A11	
13	A12	L15	14	A13	K13
	JA3-A12			JA3-A13	
15	A14	M15	16	A15	N15
	JA3-A14			JA3-A15	
17	D0	A6	18	D1	C7
	JA3-D0			JA3-D1	
19	D2	A7	20	D3	A9
	JA3-D2			JA3-D3	
21	D4	B9	22	D5	D9
	JA3-D4			JA3-D5	
23	D6	B10	24	D7	A11
	JA3-D6			JA3-D7	
25	RDn	L8	26	WR / SDWE	K8 / C11
	JA3-RDn			JA3-26PIN	
27	CSa	H10	28	CSb *1	A12
	JA3-CSa			JA3-CSb	
29	D8	D11	30	D9	A14
	JA3-D8			JA3-D9	
31	D10	B13	32	D11	D12
	JA3-D10			JA3-D11	
33	D12	B14	34	D13	C13
	JA3-D12			JA3-D13	
35	D14	E13	36	D15	B15
	JA3-D14			JA3-D15	
37	A16	M14	38	A17	N14
	JA3-A16			JA3-A17	
39	A18	P13	40	A19	R11
	JA3-A18			JA3-A19	
41	A20	P11	42	A21	R10
	JA3-A20			JA3-A21	
43	A22	R9	44	SDCLK *2	A15 / J8
	JA3-A22			JA3-44PIN	
45	CSc / Wait	M1 / G6	46	ALE / SDCKE	K7 / C14
	JA3-45PIN			JA3-46PIN	
47	HWRn / DQMH	M8 / D15	48	LWRn / DQML	K8 / C15
	JA3-47PIN			JA3-48PIN	
49	CAS	B12	50	RAS	A13
	JA3-CAS			JA3-RAS	

*1: The chip select signal assigned on this board can also be used as a SDRAM chip select.

*2: This board can also output BCLK signal to JA3 header.

Table 7-4 below lists the connections of the application header, JA5.

Table 7-4: Application Header JA5 Connections

Application Header JA5					
Pin	Header Name	MCU Pin	Pin	Header Name	MCU Pin
	Circuit Net Name			Circuit Net Name	
1	ADC4	B13	2	ADC5	D12
	JA5-ADC4			JA5-ADC5	
3	ADC6	B14	4	ADC7	C13
	JA5-ADC6			JA5-ADC7	
5	CAN1TX	H5	6	CAN1RX	H4
	JA5-CAN1TX			JA5-CAN1RX	
7	CAN2TX	NC	8	CAN2RX	NC
	NC			NC	
9	IRQe / M2_EncZ / M2HSIN1	NC / NC / NC	10	IRQf / M2_HSIN2	NC / NC
	NC			NC	
11	M2_UD	NC	12	M2_Uin	NC
	NC			NC	
13	M2_Vin	NC	14	M2_Win	NC
	NC			NC	
15	M2_Toggle	NC	16	M2_POE	NC
	NC			NC	
17	M2_TRCCLK	NC	18	M2_TRDCLK	NC
	NC			NC	
19	M2_UP	NC	20	M2_Un	NC
	NC			NC	
21	M2_VP	NC	22	M2_Vn	NC
	NC			NC	
23	M2_WP	NC	24	M2_Wn	NC
	NC			NC	

Table 7-5 below lists the connections of the application header, JA6.

Table 7-5: Application Header JA6 Connections

Application Header JA6					
Pin	Header Name	MCU Pin	Pin	Header Name	MCU Pin
	Circuit Net Name			Circuit Net Name	
1	DREQ	N1	2	DACK	M2
	JA6-DREQ			JA6-DACK	
3	TEND	NC	4	STBYn	NC
	NC			NC	
5	RS232TX	NC	6	RS232RX	NC
	JA6-RS232TX			JA6-RS232RX	
7	SClBbRX	M3	8	SClBbTX	P2
	JA6-RXDb			JA6-TXDb	
9	SClCtTX	N9	10	SClCbCK	L4
	JA6-TXDc			JA6-SCKb	
11	SClCkCK	M9	12	SClCkRX	N3
	JA6-SCKc			JA6-RXDc	
13	M1_Toggle	N14	14	M1_Uin	R4
	JA6-M1TOGGLE			JA6-M1UIN	
15	M1_Vin	P8	16	M1_Win	K7
	JA6-M1VIN			JA6-M1WIN	
17	EXT_USB_VBUS	NC	18	Reserved	NC
	NC			NC	
19	EXT_USB_BATT	NC	20	Reserved	NC
	NC			NC	
21	EXT_USB_CHG	NC	22	Reserved	NC
	NC			NC	
23	Unregulated_VCC	-	24	Vss	-
	Unregulated_VCC			GROUND	

8. Code Development

8.1 Overview

For all code debugging using Renesas software tools, the RSK+ board must be connected to a PC via an E1/E20/E2 Lite debugger. An E1/E2 Lite debugger is supplied with this RSK+ product.

For further information regarding the debugging capabilities of the E1/E20/E2 Lite debuggers, refer to E1/E20 Emulator, E2 Emulator Lite Additional Document for User's Manual (R20UT0399EJ).

8.2 Compiler Restrictions

The compiler supplied with this RSK+ is fully functional for a period of 60 days from first use. After the first 60 days of use have expired, the compiler will default to a maximum of 128k code and data. To use the compiler with programs greater than this size you need to purchase the full tools from your distributor.

The protection software for the compiler will detect changes to the system clock. Changes to the system clock back in time may cause the trial period to expire prematurely.

8.3 Mode Support

The MCU supports Single Chip and Boot Modes (SCI, USB, FINE), which are configured on the RSK+ board. Details of the modifications required can be found in §6.2. All other MCU operating modes are configured within the MCU's registers, which are listed in the RX72M Group User's Manual: Hardware.

Only ever change the MCU operating mode whilst the RSK+ is in reset, or turned off; otherwise the MCU may become damaged as a result.

8.4 Debugging Support

The E1 Emulator or E2 Emulator Lite (as supplied with this RSK+) supports break points, event points (including mid-execution insertion) and basic trace functionality. It is limited to a maximum of 8 on-chip event points, 256 software breaks and 256 branch/cycle trace. For further details, refer E1/E20 Emulator User's Manual (R20UT0398EJ) or E2 Emulator Lite User's Manual (R20UT3240EJ).

8.5 Address Space

For the MCU address space details, refer to the 'Address Space' section of RX72M Group User's Manual: Hardware.

8.6 Note of Flash Access Window Setting Register

This register is used to set the write protection flag and start-up area select flag for setting the flash access window start address, flash access window end address, and access window.

Once 0 is written to this bit, the bit can never be restored to 1.

Therefore, the access window and the BTFLG bit will never be set again. If set the TM function will never be disabled, once enabled. Exercise extra caution when handling the FSPR bit.

For details, refer to Section 7.2.9 in the RX72M Group User's Manual: Hardware.

9. Additional Information

Technical Support

For information about the RX72M Group microcontrollers refer to the RX72M Group Hardware Manual.

For information about the RX assembly language, refer to the RX Family Software Manual.

Technical Contact Details

Please refer to the contact details listed in section 8 of the “Quick Start Guide”

General information on Renesas microcontrollers can be found on the Renesas website at:

<https://www.renesas.com/>

Trademarks

All brand or product names used in this manual are trademarks or registered trademarks of their respective companies or organisations.

Copyright

This document may be, wholly or partially, subject to change without notice. All rights reserved. Duplication of this document, either in whole or part is prohibited without the written permission of Renesas Electronics Europe GmbH.

© 2019 Renesas Electronics Europe GmbH. All rights reserved.

© 2019 Renesas Electronics Corporation. All rights reserved.

REVISION HISTORY	RX72M Group Renesas Starter Kit+ for RX72M User's Manual
-------------------------	---

Rev.	Date	Description	
		Page	Summary
1.00	Jul 31, 2019	—	First Edition issued

RX72M Group
Renesas Starter Kit+ for RX72M User's Manual

Publication Date: Rev.1.00 Jul 31, 2019

Published by: Renesas Electronics Corporation

RX72M Group