



LINEAGE POWER®

QBK033A0B Series Power Modules; DC-DC Converters

36-60 Vdc Input; 12Vdc Output; 33A Output Current

RoHS Compliant



Applications

- Distributed power architectures
- Intermediate bus voltage applications
- Servers and storage applications
- Networking equipment including Power over Ethernet (PoE)

Options

- Negative Remote On/Off logic
- Active load sharing (Parallel Operation)
- Baseplate option (-H)
- Auto restart after fault shutdown
- Case ground pin

Description

The QBK033A0B series of dc-dc converters are a new generation of DC/DC power modules designed to support 12Vdc intermediate bus applications where multiple low voltages are subsequently generated using point of load (POL) converters. The QBK033A0B series operate off an input voltage range from 36 to 60Vdc and provide up to 33A output current at 12V in an industry standard quarter brick. The converter incorporates synchronous rectification technology and innovative packaging techniques to achieve efficiency reaching 94.5% at 12V full load. This leads to lower power dissipations such that for many applications a heat sink is not required.

The output is fully isolated from the input, allowing versatile polarity configurations and grounding connections. Built-in filtering for both input and output minimizes the need for external filtering.

This product is affected by a Permanent Injunction entered by the United States District Court for the Eastern District of Texas, Marshall Division in Civil Action No. 2:07-cv-00497-TJW-CE (copy enclosed). As set forth in that Order, certain acts associated with this product are prohibited. This Product is Not for Sale in, Use in, or Importation into the United States.

Features

- Compliant to RoHS EU Directive 2002/95/EC (-Z versions)
- Compliant to ROHS EU Directive 2002/95/EC with lead solder exemption (non-Z versions)
- High efficiency – 94.5% at 12V full load
- Delivers up to 33A output current
- Low output ripple and noise
- Industry standard Quarter brick:
 - 57.9 mm x 36.8 mm x 10.6 mm
 - (2.28 in x 1.45 in x 0.42 in)
- Constant switching frequency
- Positive Remote On/Off logic
- Output over current/voltage protection
- Over temperature protection
- Wide operating temperature range (-40°C to 85°C)
- ISO** 9001 certified manufacturing facilities
- UL* 60950-1 Recognised, CSA† C22.2 No. 60950-3-01 Certified, and EN 60950-1 (VDE‡ 0805): 2001-12 Licensed
- 2250 Vdc Isolation tested in compliance with IEEE 802.3[§] PoE standards

* UL is a registered trademark of Underwriters Laboratories, Inc.

† CSA is a registered trademark of Canadian Standards Association.

‡ VDE is a trademark of Verband Deutscher Elektrotechniker e.V.

** ISO is a registered trademark of the International Organization of Standards

§ IEEE and 802 are registered trademarks of the Institute of Electrical and Electronics Engineers, Incorporated.

Absolute Maximum Ratings

Stresses in excess of the absolute maximum ratings can cause permanent damage to the device. These are absolute stress ratings only, functional operation of the device is not implied at these or any other conditions in excess of those given in the operations sections of the data sheet. Exposure to absolute maximum ratings for extended periods can adversely affect device reliability.

Parameter	Device	Symbol	Min	Max	Unit
Input Voltage*					
Continuous		V_{IN}	-0.3	60	Vdc
Non- operating continuous		V_{IN}	-0.3	75	Vdc
Operating Ambient Temperature (See Thermal Considerations section)	All	T_A	-40	85	°C
Storage Temperature	All	T_{stg}	-55	125	°C
I/O Isolation Voltage (100% factory Hi-Pot tested)	All	—	—	2250	Vdc

* Input over voltage protection will shutdown the output voltage when the input voltage exceeds threshold level.

Electrical Specifications

Unless otherwise indicated, specifications apply over all operating input voltage, resistive load, and temperature conditions.

Parameter	Device	Symbol	Min	Typ	Max	Unit
Operating Input Voltage		V_{IN}	36	48	60	Vdc
Maximum Input Current ($V_{IN}=0V$ to 60V, $I_O=I_{O,max}$)		$I_{IN,max}$	-	-	13	Adc
Inrush Transient	All	I^2t	-	-	1	A ² s
Input Reflected Ripple Current, peak-to-peak (5Hz to 20MHz, 12μH source impedance; $V_{IN}=48V$, $I_O=I_{O,max}$; see Figure 9)	All		-	24	-	mAp-p
Input Ripple Rejection (120Hz)	All		50		-	dB

CAUTION: This power module is not internally fused. An input line fuse must always be used.

This power module can be used in a wide variety of applications, ranging from simple standalone operation to an integrated part of sophisticated power architecture. To preserve maximum flexibility, internal fusing is not included, however, to achieve maximum safety and system protection, always use an input line fuse. The safety agencies require a fast-acting fuse with a maximum rating of 30 A (see Safety Considerations section). Based on the information provided in this data sheet on inrush energy and maximum dc input current, the same type of fuse with a lower rating can be used. Refer to the fuse manufacturer's data sheet for further information.

Electrical Specifications (continued)

Parameter	Device	Symbol	Min	Typ	Max	Unit
Output Voltage Set-point ($V_{IN}=V_{IN,nom}$, $I_O=15A$, $T_A=25^\circ C$)	All	$V_{O,set}$		12		V _{dc}
Output Voltage (Over all operating input voltage, resistive load, and temperature conditions until end of life)		V_O	11.4	—	12.6	V _{dc}
Output Regulation Line ($V_{IN}=V_{IN,min}$ to $V_{IN,max}$)	All		—	0.2	0.3	%V _O
Load ($I_O=I_{O,min}$ to $I_{O,max}$)	All		—	3	5	%V _O
Temperature ($T_A = -40^\circ C$ to $+85^\circ C$)	All		—	150	250	mV
Output Ripple and Noise on nominal output ($V_{IN}=V_{IN,nom}$ and $I_O=I_{O,min}$ to $I_{O,max}$)						
RMS (5Hz to 20MHz bandwidth)	All		—	70	—	mV _{rms}
Peak-to-Peak (5Hz to 20MHz bandwidth)	All		—	200	—	mV _{pk-pk}
External Capacitance	All	$C_{O,max}$	0	—	10,000	μF
Output Current	All	I_O	0		33	A _{dc}
Output Current Limit Inception	All	$I_{O,lim}$	—	38	—	A _{dc}
Efficiency $V_{IN}=V_{IN,nom}$, $T_A=25^\circ C$ $I_O=I_{O,max}$, $V_O=V_{O,set}$	All	η	—	94.5	—	%
Switching Frequency		f_{sw}	—	300	—	kHz
Dynamic Load Response ($dI_O/dt=1A/10\mu s$; $V_{in}=V_{in,nom}$; $T_A=25^\circ C$; Tested with a 10 μF aluminum and a 1.0 μF tantalum capacitor across the load.)						
Load Change from $I_O= 50\%$ to 75% of $I_{O,max}$: Peak Deviation	All	V_{pk}	—	300	—	mV
Settling Time ($V_O<10\%$ peak deviation)		t_s	—	700	—	μs
Load Change from $I_O= 75\%$ to 50% of $I_{O,max}$: Peak Deviation		V_{pk}	—	300	—	mV
Settling Time ($V_O<10\%$ peak deviation)		t_s	—	700	—	μs

Isolation Specifications

Parameter	Symbol	Min	Typ	Max	Unit
Isolation Capacitance	C_{iso}	—	2000	—	pF
Isolation Resistance	R_{iso}	10	—	—	MΩ

General Specifications

Parameter	Device	Min	Typ	Max	Unit
Calculated MTBF ($I_o=80\%$ of $I_{o,max}$, $T_A=40^\circ\text{C}$, airflow=1m/s(200LFM))	All		1,423,448		Hours
Weight – Open Frame		—	49 (1.73)	—	g (oz.)
Weight – with Baseplate option		—	63.5 (2.24)	—	g (oz.)

Feature Specifications

Unless otherwise indicated, specifications apply over all operating input voltage, resistive load, and temperature conditions. See Feature Descriptions for additional information.

Parameter	Device	Symbol	Min	Typ	Max	Unit
Remote On/Off Signal Interface ($V_{IN}=V_{IN,min}$ to $V_{IN,max}$, Signal referenced to V_{IN} -terminal) Negative Logic: device code suffix "1" Logic Low = module On, Logic High = module Off Positive Logic: No device code suffix required Logic Low = module Off, Logic High = module On Logic Low Specification On/Off Thresholds:						
Remote On/Off Current – Logic Low	All	$I_{on/off}$	5	10	15	μA
Logic Low Voltage	All	$V_{on/off}$	-0.3	—	0.8	V
Logic High Voltage – (Typ = Open Collector)	All	$V_{on/off}$	2.0	—	3.5	V
Logic High maximum allowable leakage current ($V_{on/off} = 2.0\text{V}$)	All	$I_{on/off}$	—	—	4.0	μA
Maximum voltage allowed on On/Off pin	All	$V_{on/off}$	—	—	13.5	V
Turn-On Delay and Rise Times ($I_o=I_{o,max}$) T_{delay} = Time until $V_o = 10\%$ of $V_{o,set}$ from either application of V_{in} with Remote On/Off set to On or operation of Remote On/Off from Off to On with V_{in} already applied for at least one second. T_{rise} = Time for V_o to rise from 10% of $V_{o,set}$ to 90% of $V_{o,set}$. (Min @ $V_{IN,MAX}$, Typ @ $V_{IN,NOM}$, Max @ $V_{IN,MIN}$)	All	$T_{delay, Enable with V_{in}}$	—	20	—	ms
	All	$T_{delay, Enable with on/off}$	—	5	—	ms
	All	T_{rise}	29	40	68	ms
Output Overvoltage Protection (Clamp)	All		13	—	15	V
Overtemperature Protection (See Feature Descriptions)	All	T_{ref}	—	125	—	$^\circ\text{C}$
Input Undervoltage Lockout Turn-on Threshold Turn-off Threshold			—	35	36	V
			32	34	—	V

Characteristic Curves

The following figures provide typical characteristics for the QBK033A0B (12V, 33A) at 25°C. The figures are identical for either positive or negative Remote On/Off logic.

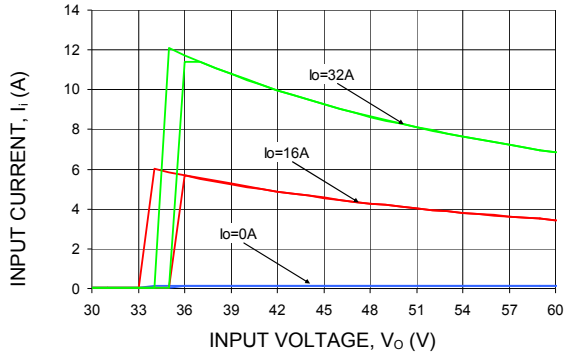

Figure 1. Typical Input Characteristic at Room Temperature.

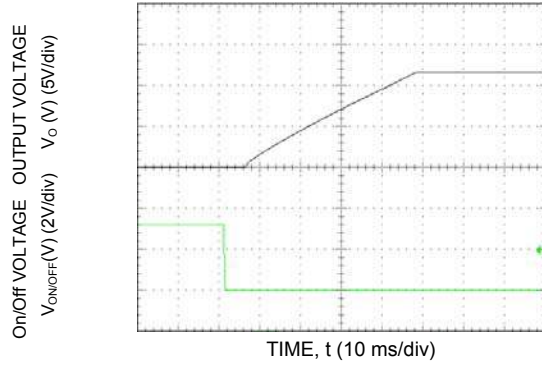

Figure 4. Typical Start-Up Using Remote On/Off, negative logic version shown.

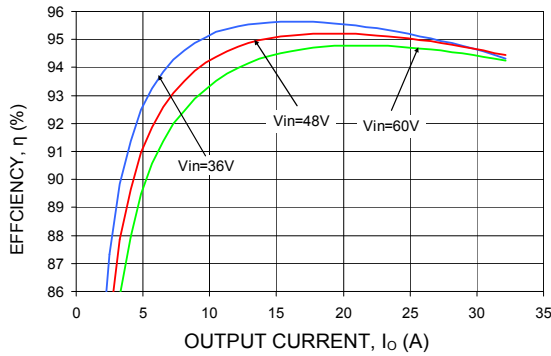

Figure 2. Typical Converter Efficiency Vs. Output current at Room Temperature.

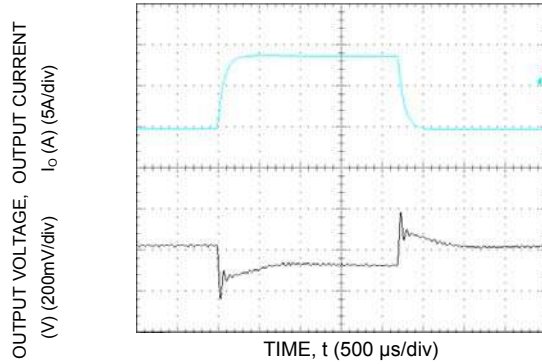

Figure 5. Typical Transient Response to Step change in Load from 25% to 50% to 25% of Full Load at Room Temperature and 48 Vdc Input.

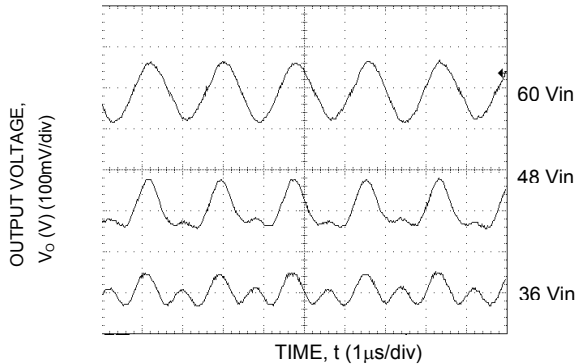

Figure 3. Typical Output Ripple and Noise at Room Temperature and $I_o = I_{o,max}$.

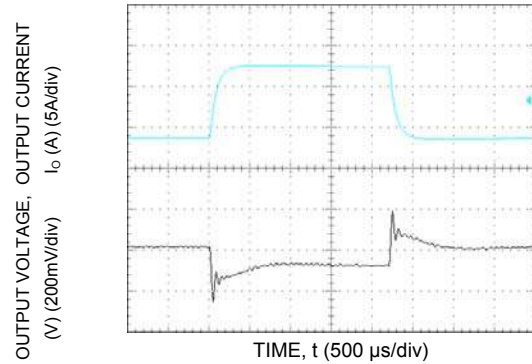

Figure 6. Typical Transient Response to Step Change in Load from 50% to 75% to 50% of Full Load at Room Temperature and 48 Vdc Input.

Characteristic Curves (continued)

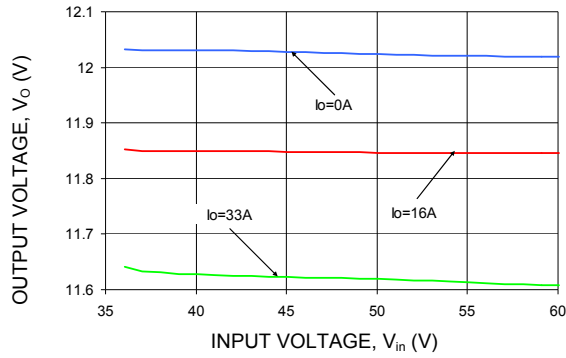

Figure 7. Typical Output voltage regulation vs. Input voltage at Room Temperature.

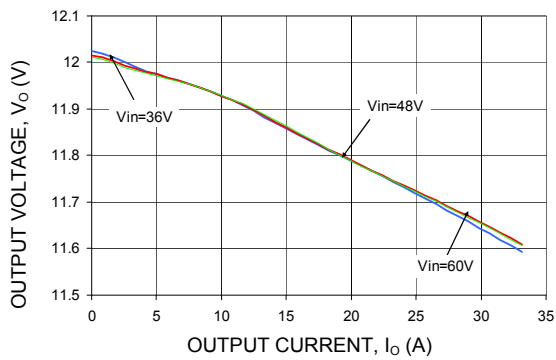
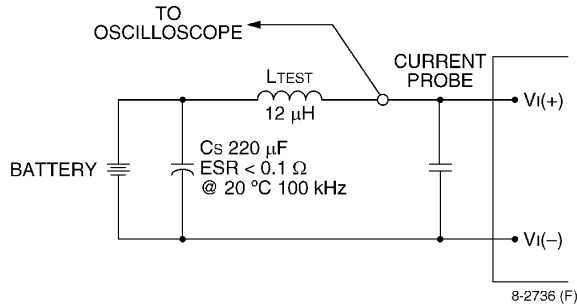

Figure 8. Typical Output voltage regulation Vs. Output current at Room Temperature.

Test Configurations



Note: Measure input reflected-ripple current with a simulated source inductance (LTEST) of 12 μH. Capacitor CS offsets possible battery impedance. Measure current as shown above.

Figure 9. Input Reflected Ripple Current Test Setup.

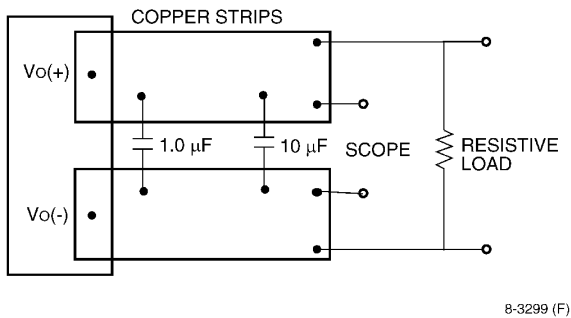

Note: Use a 1.0 μF ceramic capacitor and a 10 μF aluminum or tantalum capacitor. Scope measurement should be made using a BNC socket. Position the load between 51 mm and 76 mm (2 in. and 3 in.) from the module.

Figure 10. Output Ripple and Noise Test Setup.

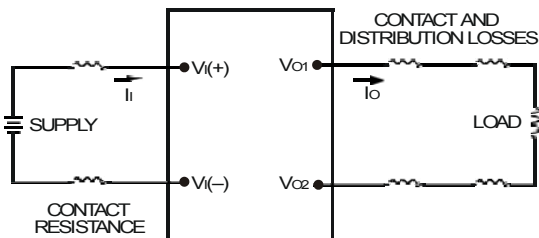

Note: All measurements are taken at the module terminals. When socketing, place Kelvin connections at module terminals to avoid measurement errors due to socket contact resistance.

$$\eta = \left(\frac{[V_{O(+)} - V_{O(-)}] I_{O}}{[V_{I(+)} - V_{I(-)}] I_{I}} \right) \times 100 \%$$

Figure 11. Output Voltage and Efficiency Test Setup.

Design Considerations

Input Source Impedance

The power module should be connected to a low ac-impedance source. A highly inductive source impedance can affect the stability of the power module. For the test configuration in Figure 9, a 100μF electrolytic capacitor (ESR<0.7Ω at 100kHz), mounted close to the power module helps ensure the stability of the unit. Consult the factory for further application guidelines.

Safety Considerations

For safety-agency approval of the system in which the power module is used, the power module must be installed in compliance with the spacing and separation requirements of the end-use safety agency standard, i.e., UL 1950, CSA C22.2 No. 60950-00, and VDE 0805:2001-12 (IEC60950 3rd Ed).

If the input source is non-SELV (ELV or a hazardous voltage greater than 60 Vdc and less than or equal to 75Vdc), for the module's output to be considered as meeting the requirements for safety extra-low voltage (SELV), all of the following must be true:

- The input source is to be provided with reinforced insulation from any other hazardous voltages, including the ac mains.
- One V_{IN} pin and one V_{OUT} pin are to be grounded, or both the input and output pins are to be kept floating.
- The input pins of the module are not operator accessible.
- Another SELV reliability test is conducted on the whole system (combination of supply source and subject module), as required by the safety agencies, to verify that under a single fault, hazardous voltages do not appear at the module's output.

Note: Do not ground either of the input pins of the module without grounding one of the output pins. This may allow a non-SELV voltage to appear between the output pins and ground.

The power module has extra-low voltage (ELV) outputs when all inputs are ELV.

The input to these units is to be provided with a maximum 30 A fast-acting (or time-delay) fuse in the unearthed lead.

Feature Descriptions

Overcurrent Protection

To provide protection in a fault output overload condition, the module is equipped with internal current-limiting circuitry and can endure current limiting for a few milliseconds. If the overcurrent condition persists beyond a few milliseconds, the module will shut down and remain latched off. The overcurrent latch is reset by either cycling the input power or by toggling the on/off pin for one second. If the output overload condition still exists when the module restarts, it will shut down again. This operation will continue indefinitely until the overcurrent condition is corrected.

An auto-restart option is also available. An auto-restart feature continually attempts to restore the operation until fault condition is cleared.

Remote On/Off

Two remote on/off options are available. Positive logic remote on/off turns the module on during a logic-high voltage on the ON/OFF pin, and off during a logic low. Negative logic remote on/off turns the module off during a logic high and on during a logic low. Negative logic, device code suffix "1," is the factory-preferred configuration. The on/off circuit is powered from an internal bias supply. To turn the power module on and off, the user must supply a switch to control the voltage between the on/off terminal and the V_i (-) terminal ($V_{on/off}$). The switch can be an open collector or equivalent (see Figure 12). A logic low is $V_{on/off} = -0.3V$ to $0.8V$. The typical $I_{on/off}$ during a logic low is $10\ \mu A$. The switch should maintain a logic-low voltage while sinking $10\ \mu A$. During a logic high, the maximum $V_{on/off}$ generated by the power module is $3.5V$. The maximum allowable leakage current of the switch at $V_{on/off} = 2.0V$ is $4\ \mu A$. If using an external voltage source, the maximum voltage V on/off on the pin is $13.5V$ with respect to the V_i (-) terminal.

If not using the remote on/off feature, perform one of the following to turn the unit on:

For negative logic, short ON/OFF pin to V_i (-).

For positive logic: leave ON/OFF pin open.

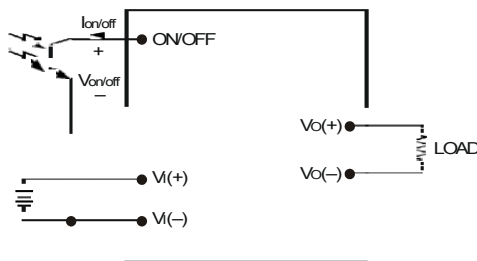

Figure 12. Remote On/Off Implementation.

Output Overvoltage Clamp

The output overvoltage clamp consists of a control circuit, independent of the primary regulation loop, that monitors the voltage on the output terminals and clamps the voltage when it exceeds the overvoltage set point. The control loop of the clamp has a higher voltage set point than the primary loop. This provides a redundant voltage control that reduces the risk of output overvoltage.

Overtemperature Protection

These modules feature an overtemperature protection circuit to safeguard against thermal damage. The circuit shuts down and latches off the module when the maximum device reference temperature is exceeded. The module can be restarted by cycling the dc input power for at least one second or by toggling the remote on/off signal for at least one second.

Input Under/Over voltage Lockout

At input voltages above or below the input under/over voltage lockout limits, module operation is disabled. The module will begin to operate when the input voltage level changes to within the under and overvoltage lockout limits.

Forced Load Sharing (Parallel Operation with -P option)

For additional power requirements, the power module can be configured for parallel operation with forced load sharing. Good layout techniques should be observed for noise immunity when using multiple units in parallel. To implement forced load sharing, the following connections should be made:

- The share pins of all units in parallel must be connected together. The path of these connections should be as direct as possible.
- The on/off pins of all modules should also be tied together so that the modules are turned on and off at the same time.
- These modules do not block reverse current flow upon start-up, and can sink large currents from the energized output bus, which may cause other converters to reach their overcurrent limits, and/or exceed this module's device internal ratings. The use of OR'ing diodes or FETS to block reverse current flow is strongly encouraged to prevent module damage, or abnormal tripping of other parallel converters.

When not using the parallel feature, leave the share pin open.

The auto-restart option (4) is not available for modules with the parallel, -P, option.

Feature Descriptions (continued)

Thermal Considerations

The power modules operate in a variety of thermal environments and sufficient cooling should be provided to help ensure reliable operation.

Thermal considerations include ambient temperature, airflow, module power dissipation, and the need for increased reliability. A reduction in the operating temperature of the module will result in an increase in reliability. The thermal data presented here is based on physical measurements taken in a wind tunnel.

Heat-dissipating components are mounted on the top side of the module. Heat is removed by conduction, convection and radiation to the surrounding environment. Proper cooling can be verified by measuring the thermal reference temperature (T_H). Peak temperature (T_H) occurs at the position indicated in Figure 13. For reliable operation this temperature should not exceed the listed temperature threshold.

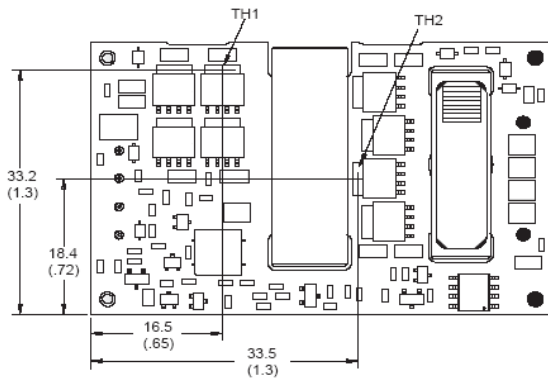

Figure 13. Location of the thermal reference temperature T_H .

The output power of the module should not exceed the rated power for the module as listed in the Ordering Information table.

Although the maximum T_H temperature of the power modules is 110 °C - 115 °C, you can limit this temperature to a lower value for extremely high reliability.

Please refer to the Application Note “Thermal Characterization Process For Open-Frame Board-Mounted Power Modules” for a detailed discussion of thermal aspects including maximum device temperatures.

Heat Transfer via Convection

Increased airflow over the module enhances the heat transfer via convection. The thermal derating figures (14-16) show the maximum output current that can be

delivered by each module in the respective orientation without exceeding the maximum T_H temperature versus local ambient temperature (T_A) for air flows of 1 m/s (200 ft./min), 2 m/s (400 ft./min) and 3 m/s (600 ft./min).

The use of Figures 14 - 15 are shown in the following example:

Example

What is the minimum airflow necessary for a QBK033A0B operating at $V_I = 48$ V, an output current of 16A, and a maximum ambient temperature of 70 °C in transverse orientation.

Solution:

Given: $V_I = 48$ V, $I_o = 17$ A, $T_A = 70$ °C

Determine required airflow (V) (Use Figure 14):

$V = 1.0$ m/sec. (200 ft./min.) or greater.

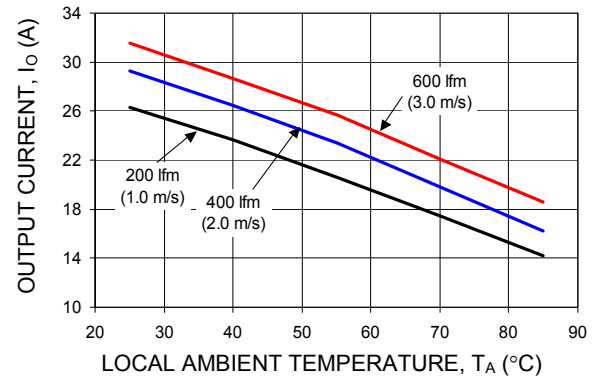

Figure 14. Output Current Derating for the QBK033A0B in the Transverse Orientation; Airflow Direction from $V_{in}(+)$ to $V_{in}(-)$; $V_{in} = 48$ V.

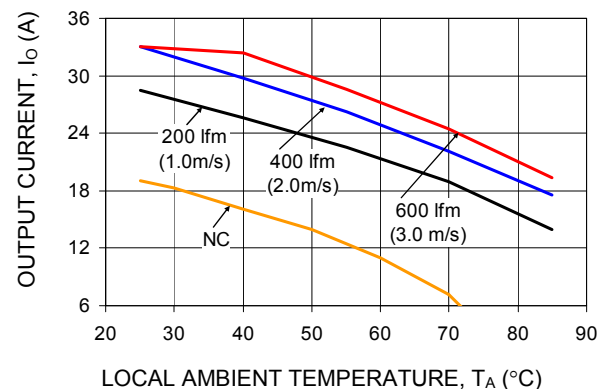

Figure 15. Output Current Derating for the QBK033A0B ($V_o = 12$ V) in the Transverse Orientation with baseplate; Airflow Direction from $V_{in}(+)$ to $V_{in}(-)$; $V_{in} = 48$ V.

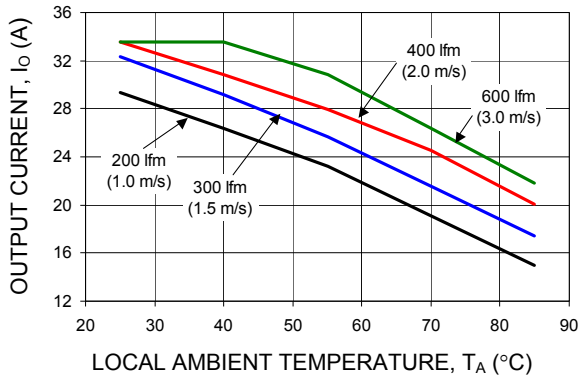

Figure 16. Output Current Derating for the QBK033A0B ($V_o = 12V$) in the Transverse Orientation with baseplate and 0.25-inch high heatsink; Airflow Direction from $V_{in}(+)$ to $V_{in}(-)$; $V_{in} = 48V$.

Layout Considerations

The QBK033 power module series are low profile in order to be used in fine pitch system card architectures. As such, component clearance between the bottom of the power module and the mounting board is limited. Avoid placing copper areas on the outer layer directly underneath the power module. Also avoid placing via interconnects underneath the power module.

For additional layout guide-lines, refer to FLTR100V10 data sheet.

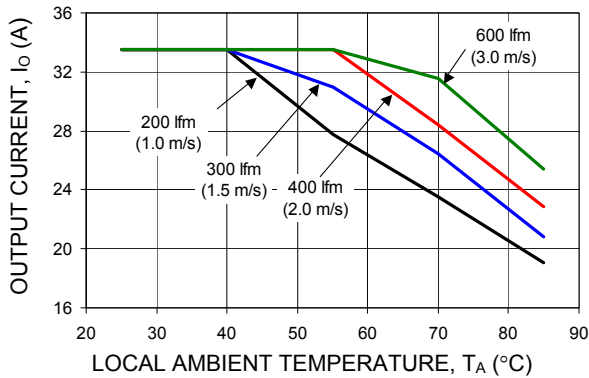

Figure 17. Output Current Derating for the QBK033A0B ($V_o = 12V$) in the Transverse Orientation with baseplate and 0.5-inch high heatsink; Airflow Direction from $V_{in}(+)$ to $V_{in}(-)$; $V_{in} = 48V$.

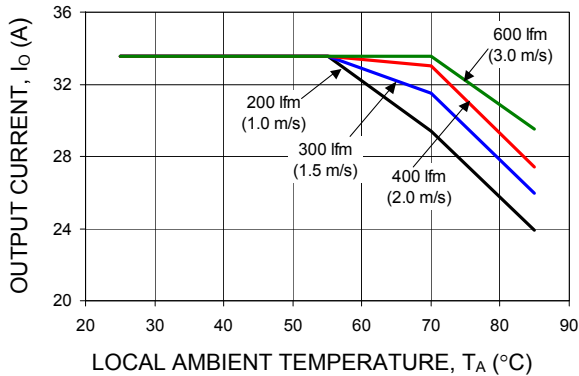

Figure 18. Output Current Derating for the QBK033A0B ($V_o = 12V$) in the Transverse Orientation with baseplate and 1.0-inch high heatsink; Airflow Direction from $V_{in}(+)$ to $V_{in}(-)$; $V_{in} = 48V$.

Mechanical Outline for QBK033A0B Through-hole Module

Dimensions are in millimeters and [inches].

Tolerances: x.x mm ± 0.5 mm [x.xx in. ± 0.02 in.] (Unless otherwise indicated)

x.xx mm ± 0.25 mm [x.xxx in ± 0.010 in.]

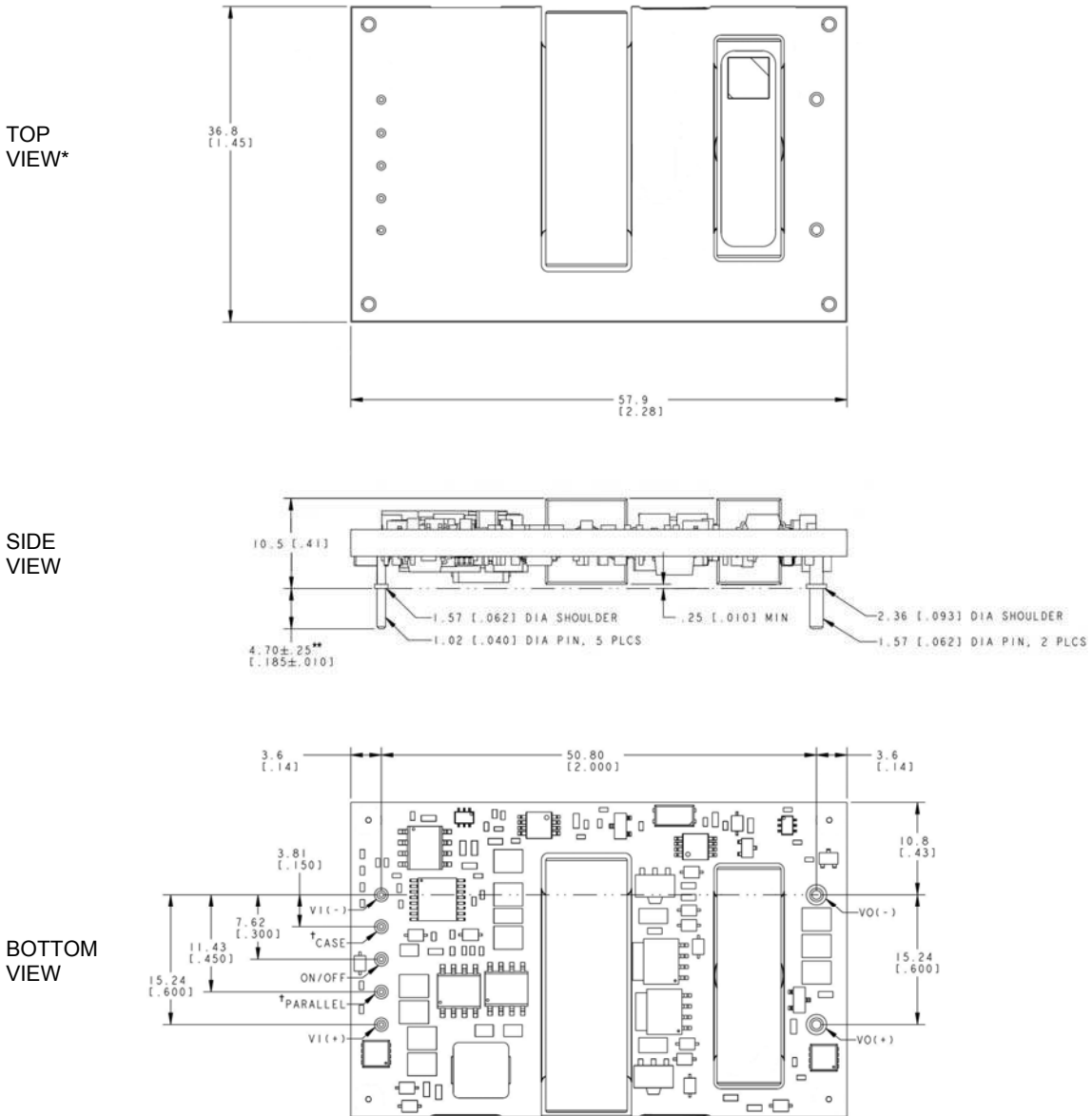

*Top side label includes Lineage Power name, product designation, and data code.

** Standard pin tail length. Optional pin tail lengths shown in Table 2 Device Options.

†Option Feature, pin is not present unless one these options specified.

Mechanical Outline for QBK –H (Baseplate version) Through-hole Module

Dimensions are in millimeters and [inches].

Tolerances: x.x mm ± 0.5 mm [x.xx in. ± 0.02 in.] (Unless otherwise indicated)

x.xx mm ± 0.25 mm [x.xxx in ± 0.010 in.]

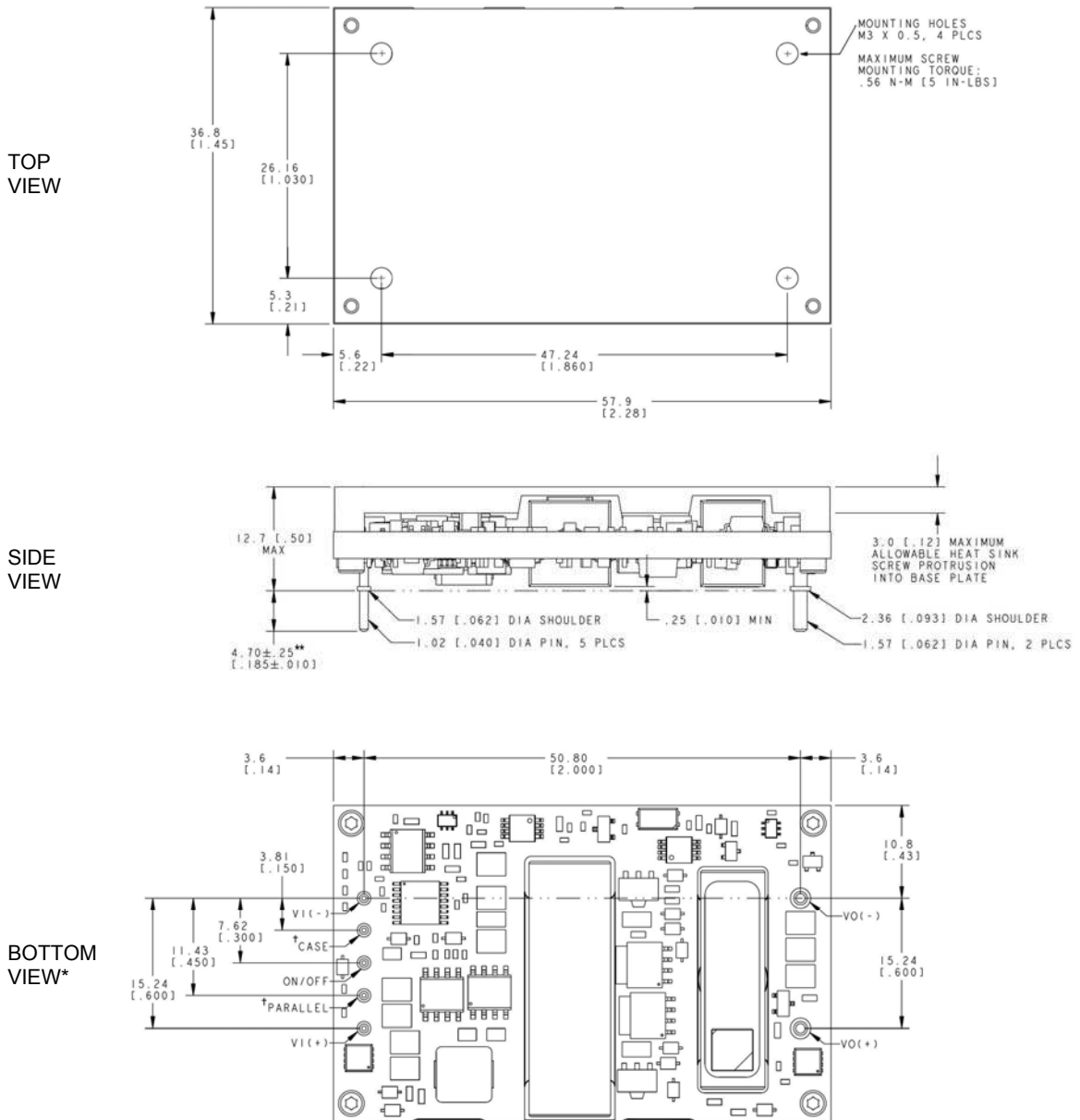

*Bottom side label includes Lineage Power name, product designation, and data code.

** Standard pin tail length. Optional pin tail lengths shown in Table 2 Device Options.

†Option Feature, pin is not present unless one of these options is specified.

Through-Hole Lead-Free Soldering Information

The RoHS-compliant through-hole products use the SAC (Sn/Ag/Cu) Pb-free solder and RoHS-compliant components. They are designed to be processed through single or dual wave soldering machines. The pins have an RoHS-compliant finish that is compatible with both Pb and Pb-free wave soldering processes. A maximum preheat rate of 3°C/s is suggested. The wave preheat process should be such that the temperature of the power module board is kept below 210°C. For Pb solder, the recommended pot temperature is 260°C, while the Pb-free solder pot is 270°C max. Not all RoHS-compliant through-hole products can be processed with paste-through-hole Pb or Pb-free reflow process. If additional information is needed, please consult with your Lineage Power representative for more details.

Post Solder Cleaning and Drying Considerations

Post solder cleaning is usually the final circuit-board assembly process prior to electrical board testing. The result of inadequate cleaning and drying can affect both the reliability of a power module and the testability of the finished circuit-board assembly. For guidance on appropriate soldering, cleaning and drying procedures, refer to Lineage Power *Board Mounted Power Modules: Soldering and Cleaning* Application Note (AP01-056EPS).

Ordering Information

Please contact your Lineage Power Sales Representative for pricing, availability and optional features.

Table 1. Device Codes

Product codes	Input Voltage	Output Voltage	Output Current	Efficiency	Connector Type	Comcodes
QBK033A0B41	48V (36–60Vdc)	12V	33A	95%	Through hole	108994793
QBK033A0B641	48V (36–60Vdc)	12V	33A	95%	Through hole	CC109104361
QBK033A0B41-H	48V (36–60Vdc)	12V	33A	95%	Through hole	108996212
QBK033A0B7641-BH	48V (36–60Vdc)	12V	33A	95%	Through hole	CC109124970
QBK033A0B741-H37	48V (36–60Vdc)	12V	33A	95%	Through hole	108996220
QBK033A0B41-HZ	48V (36–60Vdc)	12V	33A	95%	Through hole	CC109125523
QBK033A0B1-PHZ	48V (36–60Vdc)	12V	33A	95%	Through hole	CC109134268
QBK033A0B741-H37Z	48V (36–60Vdc)	12V	33A	95%	Through hole	CC109120615
QBK033A0B7541-HZ	48V (36–60Vdc)	12V	33A	95%	Through hole	CC109145141

-Z Indicates RoHS compliant modules

Table 2. Device Options

Option	Suffix
Negative remote on/off logic	1
Auto-restart (Note: Not available with –P option)	4
Pin length 6.35 ± 0.25mm (0.250 ± 0.010 in.)	5
Pin length 3.68 ± 0.25mm (0.145 ± 0.010 in.)	6
Case ground pin (offered with baseplate option only)	7
Pin length 2.79 ± 0.25mm (0.110 ± 0.010 in.)	8
Base Plate option	-H
Active load sharing (Parallel Operation)	-P

Note: Legacy device codes may contain a –B option suffix to indicate 100% factory Hi-Pot tested to the isolation voltage specified in the Absolute Maximum Ratings table. The 100% Hi-Pot test is now applied to all device codes, with or without the –B option suffix. Existing comcodes for devices with the –B suffix are still valid; however, no new comcodes for devices containing the –B suffix will be created.



World Wide Headquarters
Lineage Power Corporation
601 Shiloh Road, Plano, TX 75074, USA
+1-888-LINEAGE(546-3243)
(Outside U.S.A.: +1-972-244-WATT(9288))
www.lineagepower.com
e-mail: techsupport1@lineagepower.com

Asia-Pacific Headquarters
Tel: +86.021.54279977*808

Europe, Middle-East and Africa Headquarters
Tel: +49.89.878067-280

India Headquarters
Tel: +91.80.28411633

Lineage Power reserves the right to make changes to the product(s) or information contained herein without notice. No liability is assumed as a result of their use or application. No rights under any patent accompany the sale of any such product(s) or information.

Lineage Power DC-DC products are protected under various patents. Information on these patents is available at www.lineagepower.com/patents.

© 2010 Lineage Power Corporation, (Plano, Texas) All International Rights Reserved.

This product is affected by a Permanent Injunction entered by the United States District Court for the Eastern District of Texas, Marshall Division in Civil Action No. 2:07-cv-00497-TJW-CE (copy enclosed). As set forth in that Order, certain acts associated with this product are prohibited. This Product is Not for Sale in, Use in, or Importation into the United States.

Document No: DS05-018 ver 1.22
PDF Name: QBK033A0B.pdf