

Gen 2

Industrial pH/ORP/Temp Probe

Reads **pH, ORP and Temperature**

Range **pH: 0 – 14**
ORP: -2000mV – 2000mV
Temp: 1 – 99 °C

Accuracy **pH: +/- 0.002**
ORP: +/- 1mV
Temp: +/- (0.15 + (0.002*t))

Temperature range °C **1 – 99 °C**

Max pressure **100 PSI**

Max depth **70m (230 ft)**

Connector **Male SMA**

Cable length **3 meters**

Internal temperature sensor **Yes (PT-1000)**

Life expectancy **~4 Years +**

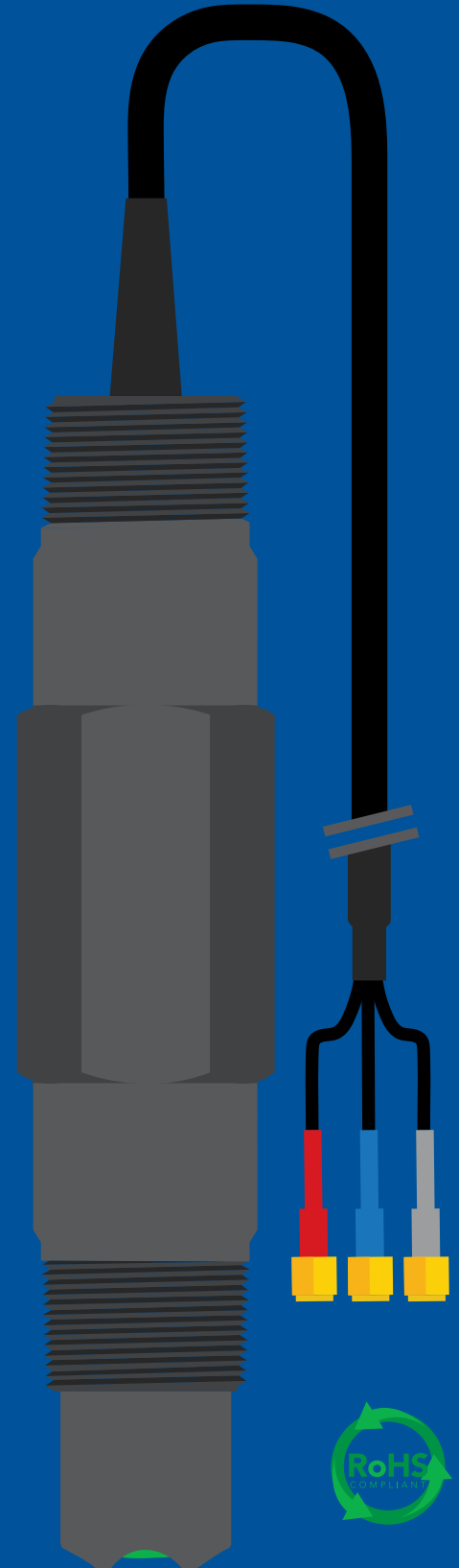

1980's — Today



**Despite appearances
THE KCl CREEP
is really quite harmless.**

The white crystals
you may find on your electrode
are formed by potassium chloride (KCl)
from the electrode filling solution.
Rinse the KCl from the electrode
with distilled water and proceed as usual.



**Dried KCl residue
from pH/ORP
storage solution**

Decades later...

KCl continues to behave the same way.

If you encounter the "KCl CREEP" or, if your probe dried out during shipping; Simply rinse off your probe with water, and carry on.

Your probe is not damaged.

Measurements

Storage Life ~5 Years
Working Life ~4+ Years

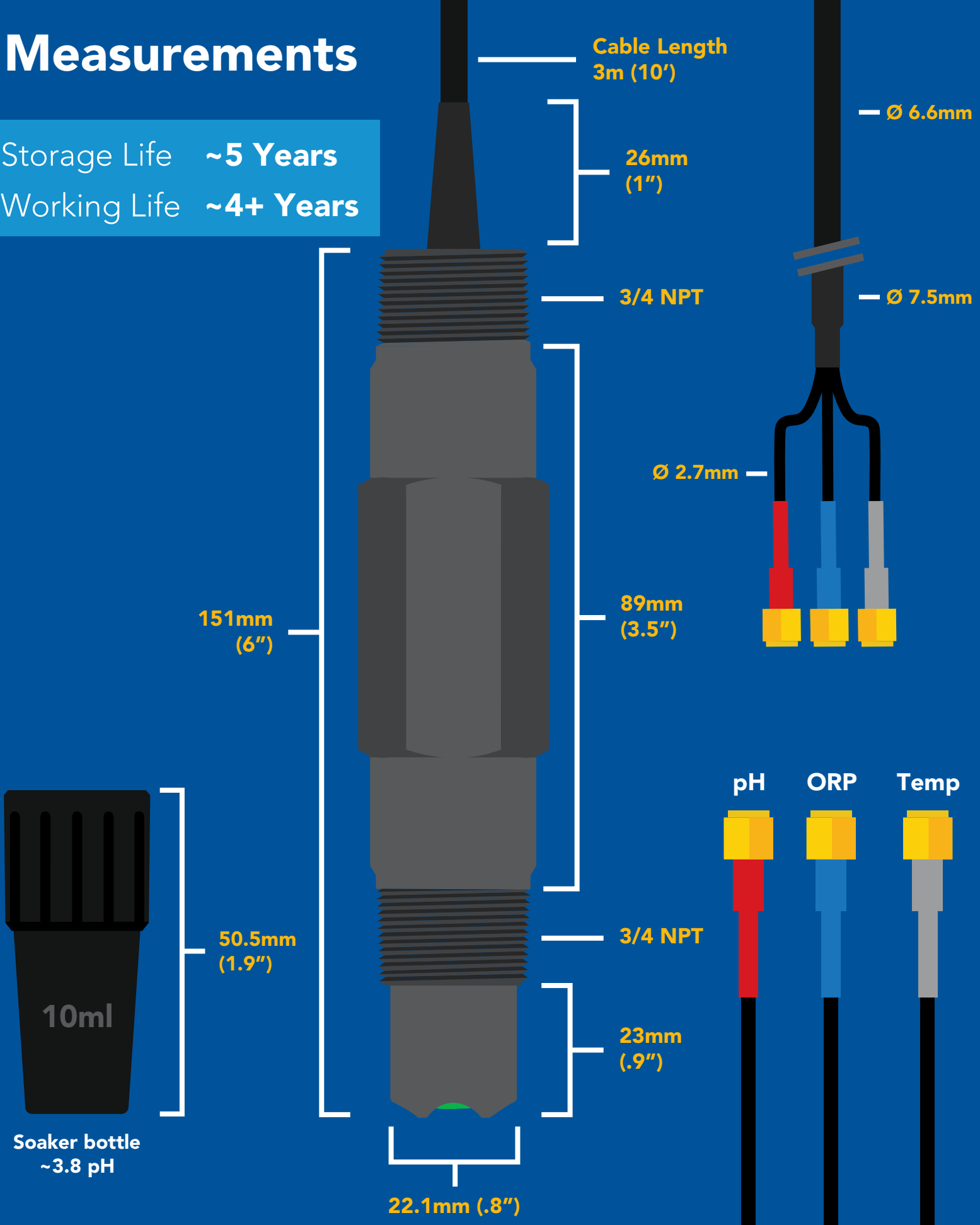

Specifications

Body material	Gray CPVC
Max depth	70m (230 ft)
Cable length	3m (10 feet)
Internal temp. probe	Yes (PT-1000)
Temp. probe type	Class A platinum, RTD
Temp. accuracy	+/- (0.15 + (0.002*t))
SMA connector	Male
Weight	357 grams
Threading	(3/4") NPT
Sterilization	Chemical only
Food safe	Yes



Materials

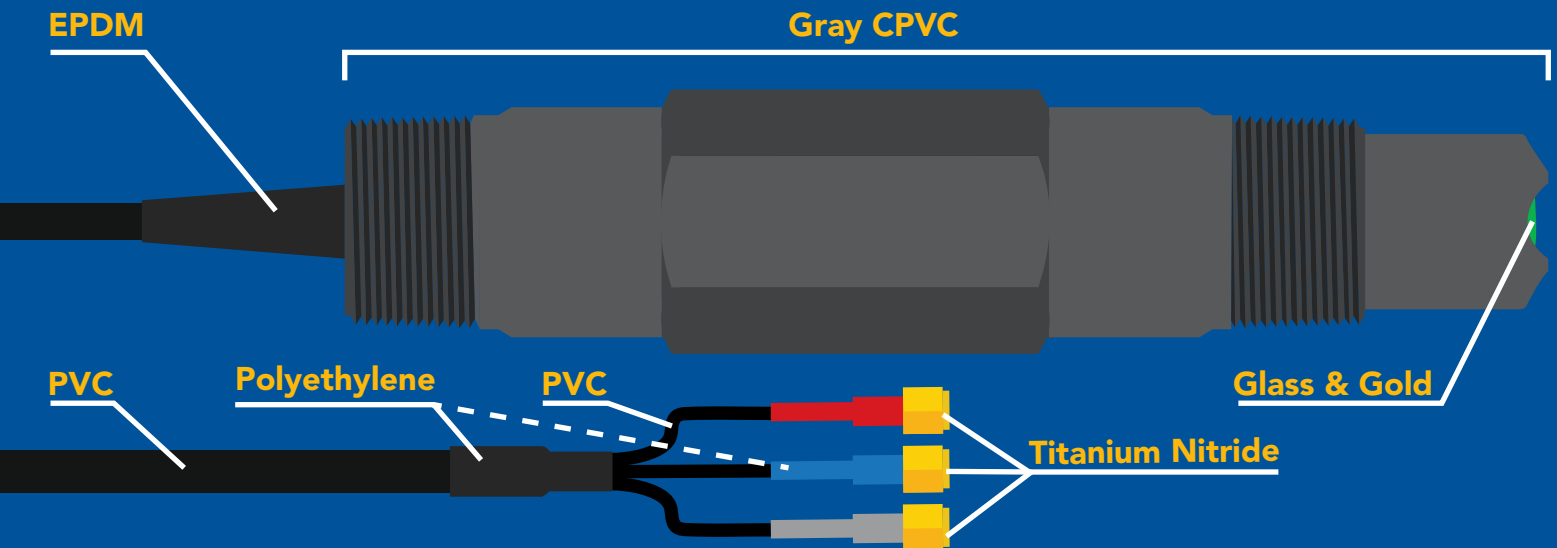

This probe can be **fully submerged** in fresh or salt water, up to the SMA connectors **indefinitely**.

NSF/ANSI 51 Compliant

Food Safe

Atlas Scientific LLC, hereby certifies that,

Industrial pH/ORP/Temp probe

Part # ENV-50-TPO

meets the NSF/ANSI Std. 51,
Whether or not they bear the NSF Mark.

EPDM

Gray CPVC
(body)

PVC

Polyethylene

PVC

Polyethylene

Titanium Nitride

✓ **PVC**
NSF-51 Compliant

✓ **Glass**
NSF-51 Compliant

✓ **EPDM**
NSF-51 Compliant

✓ **Gray CPVC**
NSF-51 Compliant

✓ **Polyethylene**
NSF-51 Compliant

✓ **Titanium Nitride**
NSF-51 Compliant

Glass & Gold

EXR advanced sensing glass

Our newest Industrial pH probes have EXR advanced sensing glass; located at the very tip of the glass bulb. The EXR advanced sensing glass has been specially formulated; allowing for faster reactions and more accurate readings in low ionic solutions.

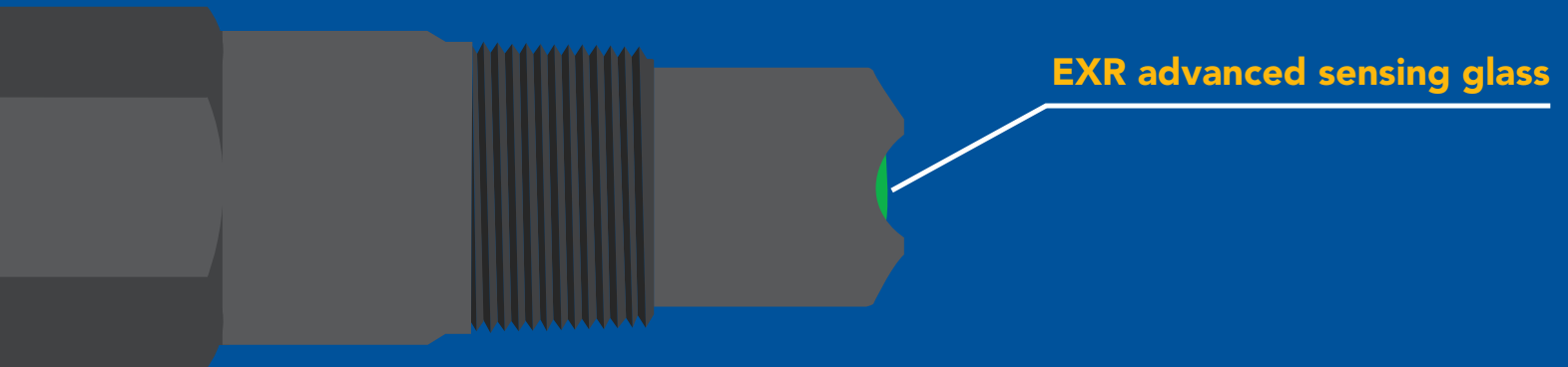

EXR advanced sensing glass

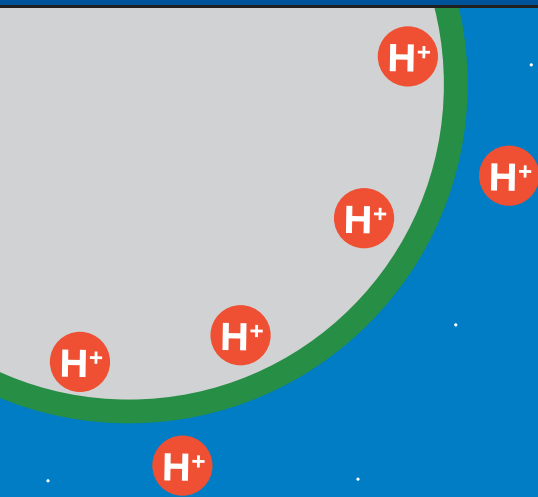

EXR advanced sensing glass
in low ionic solution

✓ pH 10

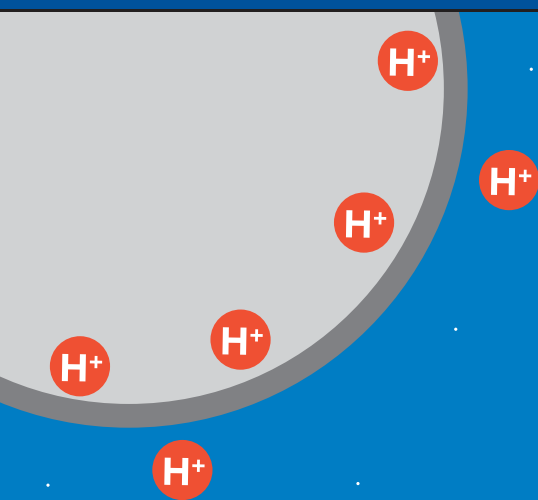

Normal sensing glass
in low ionic solution

X Undetectable

Probe cross section

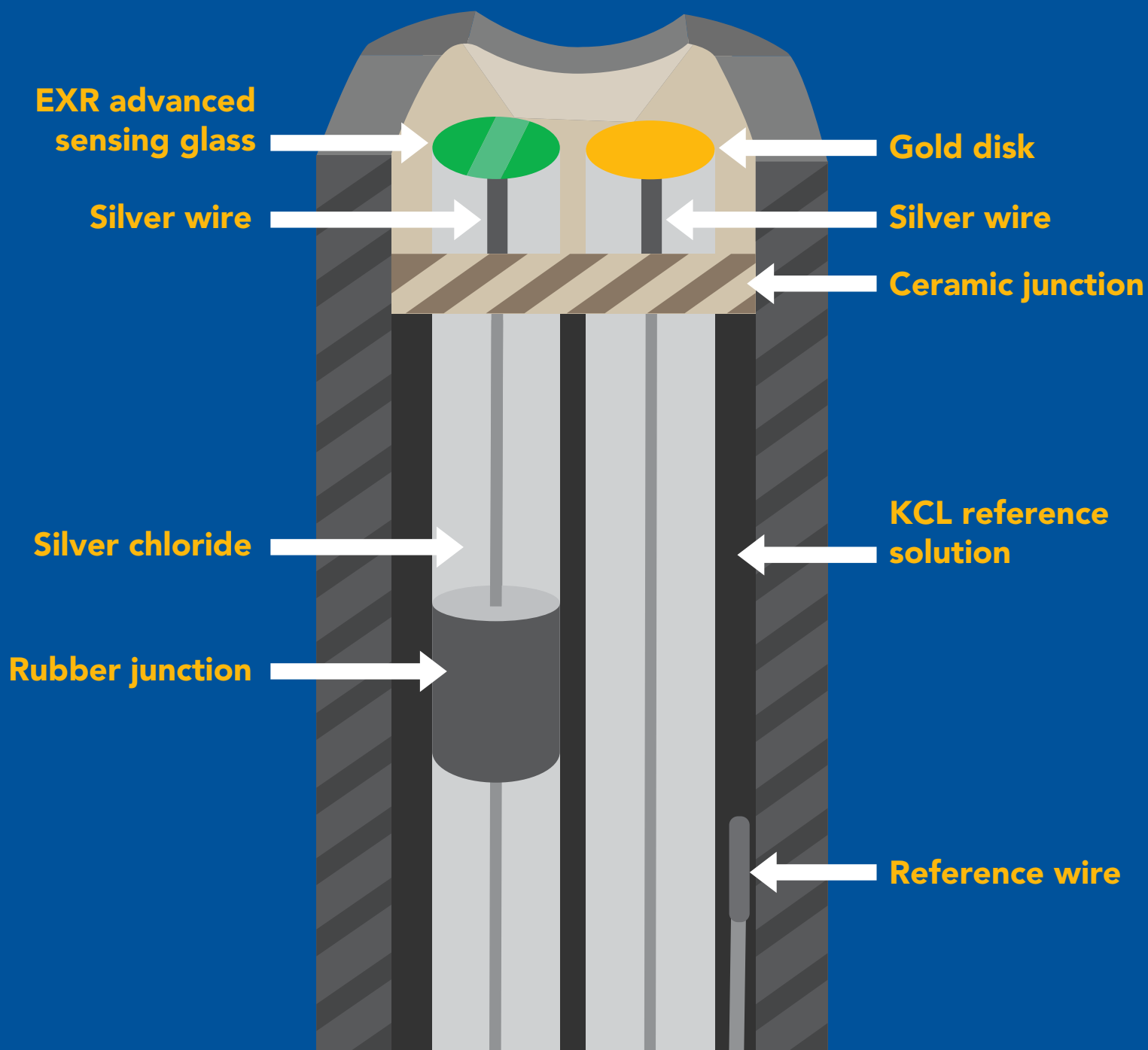

pH Operating principle

A pH (**potential of Hydrogen**) probe measures the hydrogen ion activity in a liquid. At the tip of a pH probe is a glass membrane. This glass membrane permits hydrogen ions from the liquid being measured to diffuse into the outer layer of the glass, while larger ions remain in the solution. The difference in the concentration of hydrogen ions (outside the probe vs. inside the probe) creates a VERY small current. This current is proportional to the concentration of hydrogen ions in the liquid being measured.

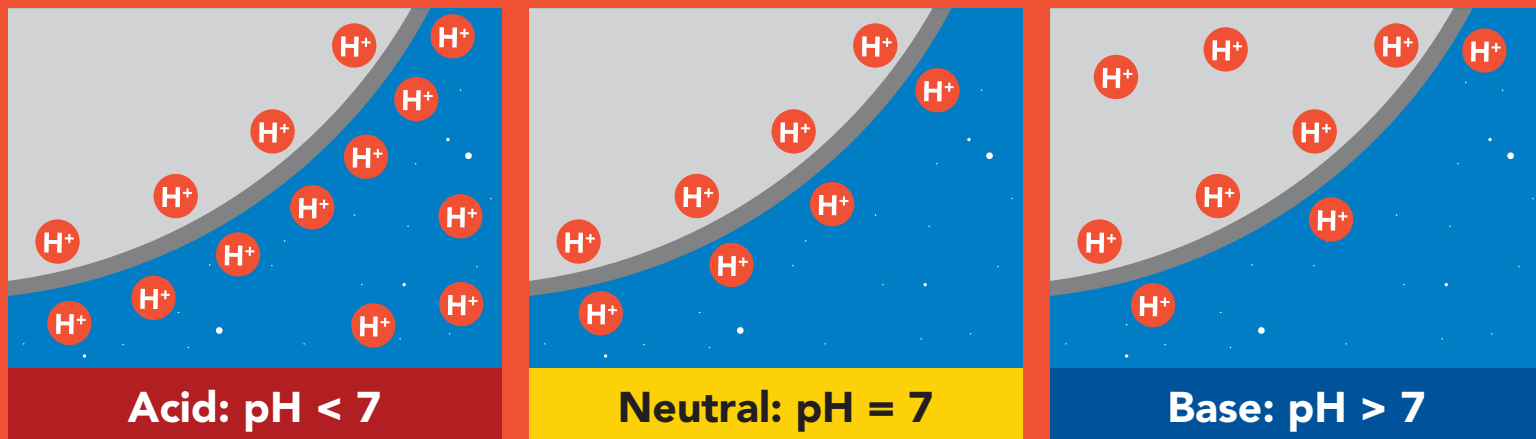

A pH electrode is a passive device that detects a current generated from hydrogen ion activity. This current (*which can be positive or negative*) is very weak and cannot be detected with a multimeter, or an analog to digital converter. This weak electrical signal can easily be disrupted and care should be taken to only use proper connectors and cables.

The current that is generated from the hydrogen ion activity is the reciprocal of that activity and can be predicted using this equation:

$$E = E^0 + \frac{RT}{F} \ln(\alpha_{H^+}) = E^0 - \frac{2.303RT}{F} pH$$

Where **R** is the ideal gas constant.

T is the temperature in Kelvin.

F is the Faraday constant.

Because a pH probe is a passive device it can pick up voltages that are transmitted through the solution being measured. This will result in incorrect readings and will slowly damage the pH probe over time. In this instance, proper isolation is required.

ORP Operating principle

ORP stands for **oxidation/reduction potential**. Oxidation is the loss of electrons and reduction is the gain of electrons. The output of the probe is represented in millivolts and can be positive or negative.

Just like a pH probe measures hydrogen ion activity in a liquid; an ORP probe measures electron activity in a liquid. The ORP readings represents how strongly electrons are transferred to or from substances in a liquid. Keeping in mind that the readings do not indicate the amount of electrons available for transfer.

When reading the ORP of a liquid that has very few electrons available for transfer, ORP readings can appear to be inconsistent.

The water is unreactive and has only trace amounts of electron movement. *These readings are equivalent to the readings you see with an unconnected multimeter.*

-234.6
Reading A

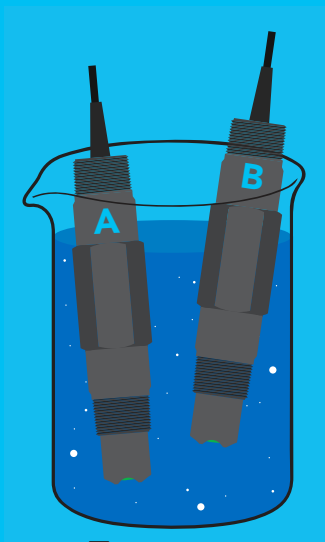

Tap water

24.2
Reading B

606.9
Reading A
(Theoretical value)

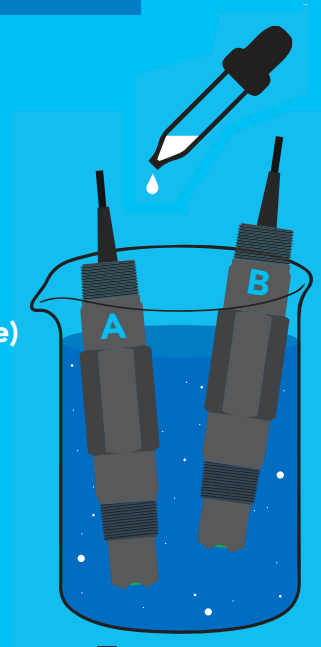

Tap water

**Add just a drop of bleach
(which is an oxidizing agent)**

605.3
Reading B

An ORP probe is a passive device that detects a current generated from the oxidation or reduction chemical substances in water. This current (which can be positive or negative) is very weak and cannot be detected with a multimeter, or an analog to digital converter.

Temperature Operating principle

Unlike any other material, platinum's correlation between resistance and temperature seems to be woven into the fabric of the universe. It is for this reason, that the platinum RTD temperature sensor is the industrial standard for temperature measurement.

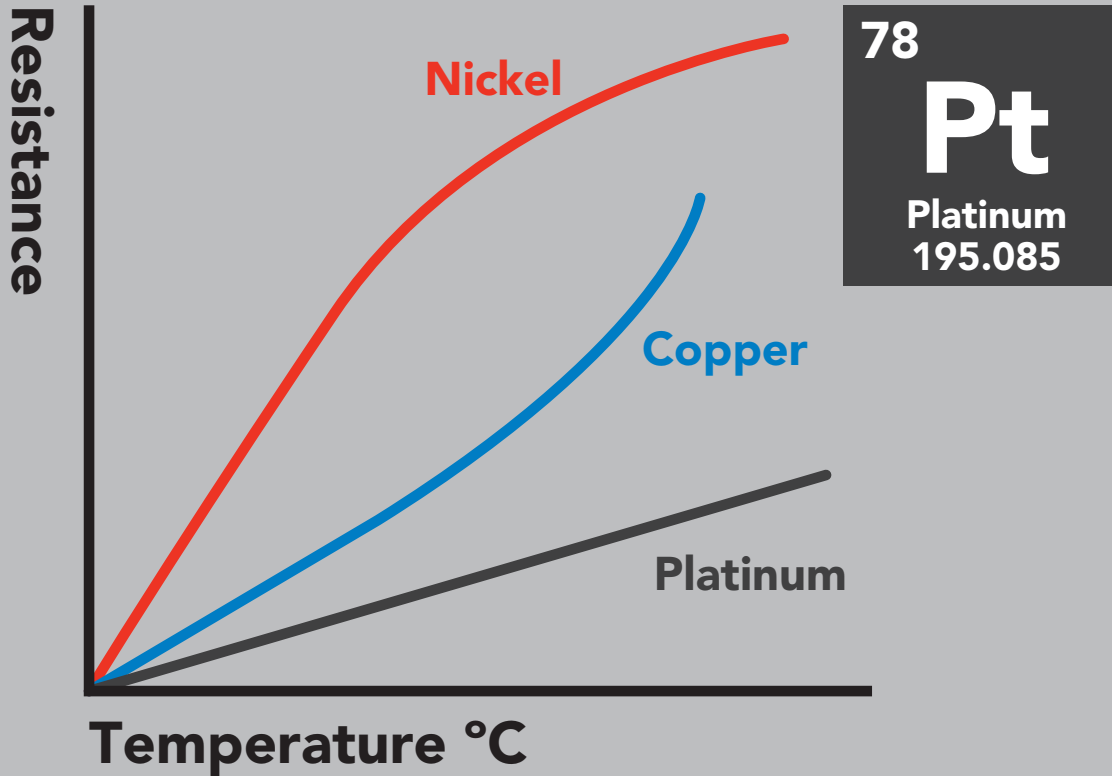

The PT-1000 temperature probe is a resistance type thermometer. Where PT stands for platinum and 1000 is the measured resistance of the probe at 0°C in ohms (1k at 0°C). As the temperature changes the resistance of the platinum changes.

To convert the resistance of the probe to temperature, use the following simplified equation:

$$T = - \frac{\sqrt{(-0.00232(R) + 17.59246)} - 3.908}{0.00116}$$

T = Degrees Celsius

R = Resistance measured from PT-1000 temperature probe

How to connect the Industrial pH/ORP/Temp Probe

The Atlas Scientific™ Industrial pH/ORP/Temp probe can be connected in several different ways. The following show two examples:

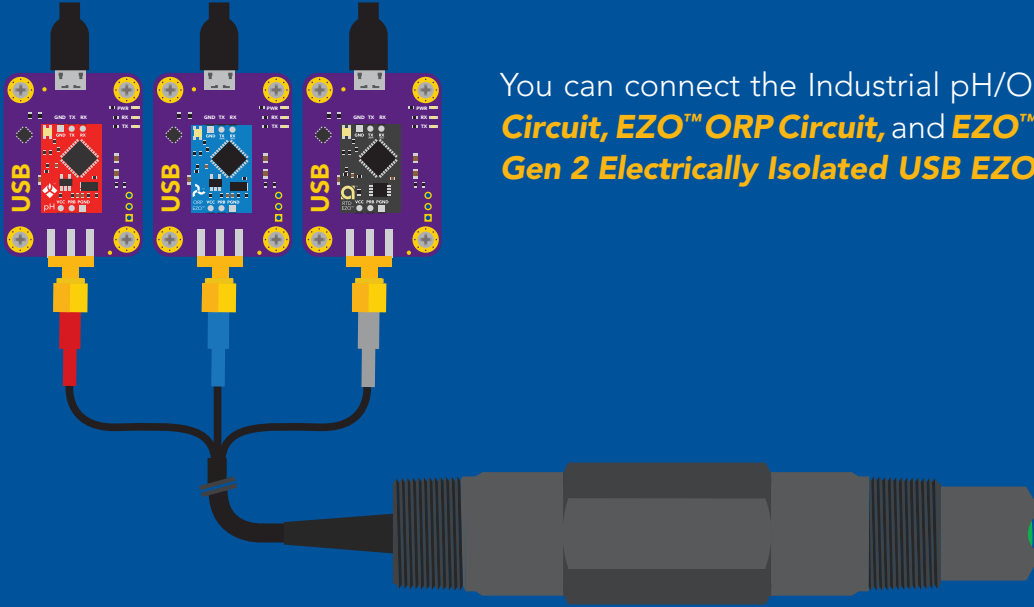

You can connect the Industrial pH/ORP/Temp probe to our **EZO™ pH Circuit**, **EZO™ ORP Circuit**, and **EZO™ RTD Temperature Circuit** via our **Gen 2 Electrically Isolated USB EZO™ Carrier Boards**.

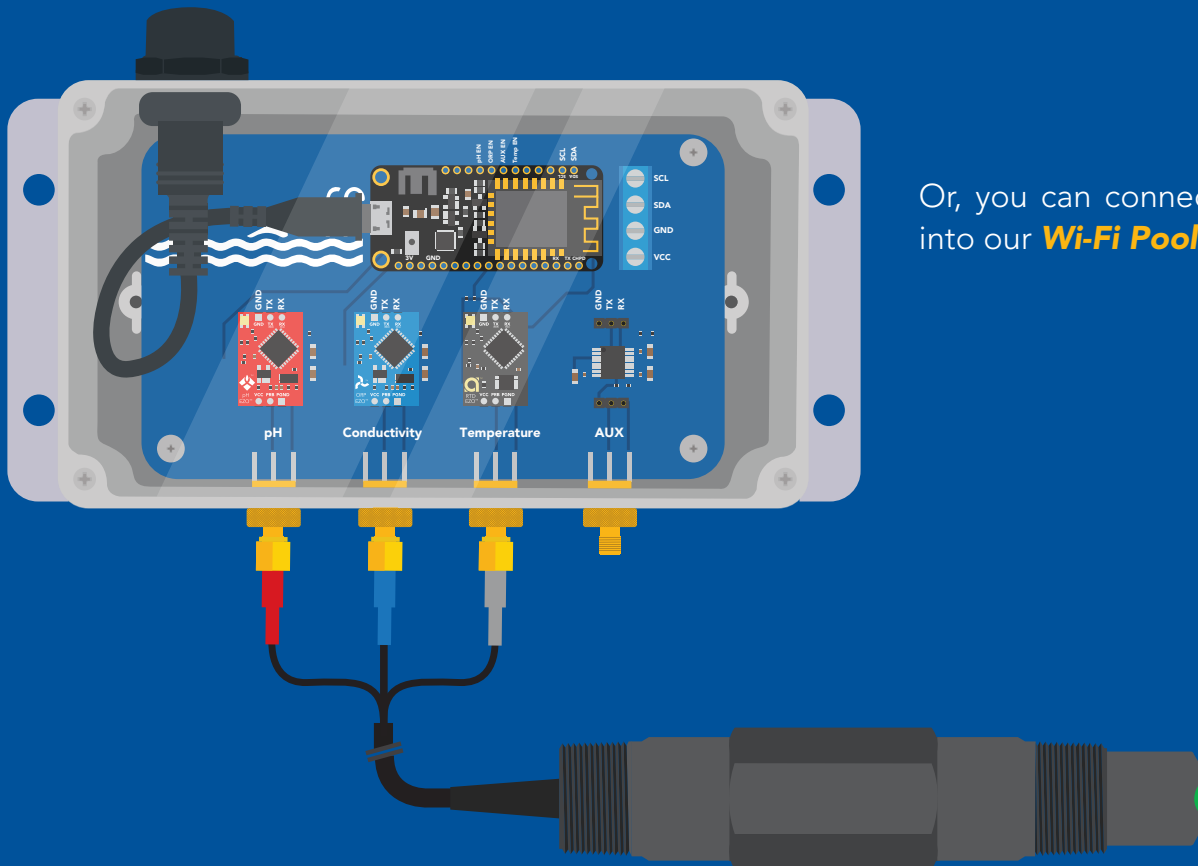

Or, you can connect this probe into our **Wi-Fi Pool Kit**.

Once installed into your machine, the Industrial pH/ORP/Temp probe must stay wet and cannot be allowed to dry out, this is why every probe is shipped with a plastic cap containing pH/ORP probe storage solution. The cap should remain on the probe until it is used.

Remove the probes cap by turning it clockwise, and pulling the probe out.



Long term storage

When you are finished using the Industrial pH/ORP/Temp probe, you can prepare the probe to be used again for a later date. First, make sure the probe cap still has pH probe storage solution within it. If not, just add some from the pH probe storage solution bottle. Tighten the cap back onto the probe by turning it counterclockwise.

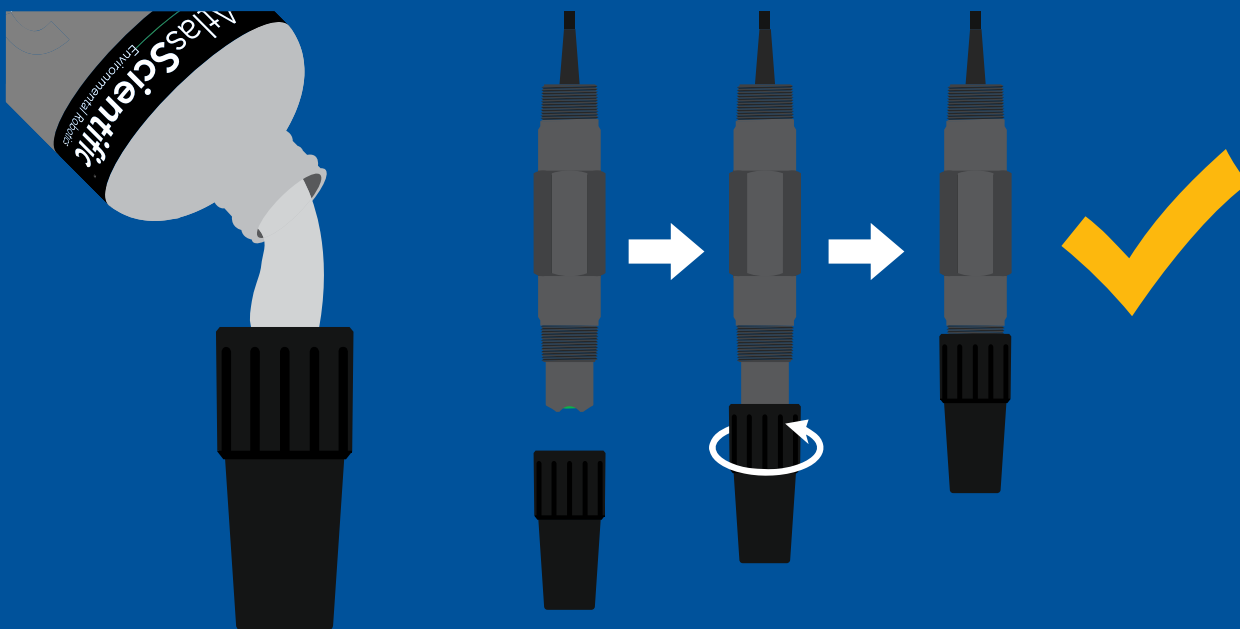

Probe cleaning

Coatings on the pH bulb and gold disk can lead to erroneous readings including shortened span (slope). The type of coating will determine the cleaning technique. Soft coatings can be removed by vigorous stirring or by the use of a squirt bottle. Organic chemical, or hard coatings, should be chemically removed using a light bleach solution. If cleaning does not restore performance, reconditioning may be tried.

Do not use abrasive materials on the Industrial pH/ORP/Temp probe.

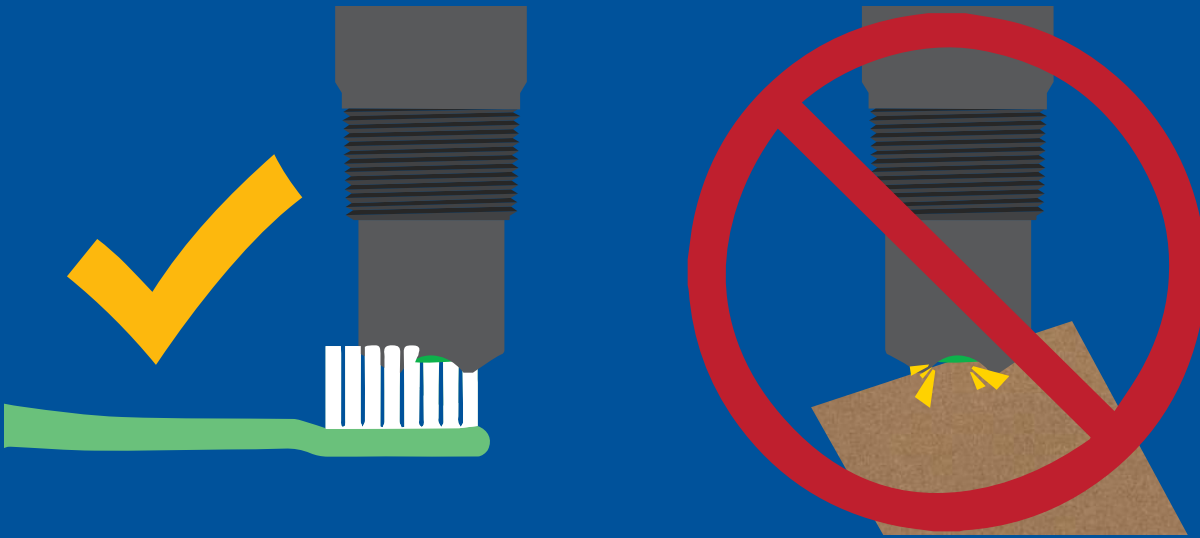

How often do you need to recalibrate the probe?

Because every use case is different, there is no set schedule for recalibration.

If you are using your probe in a fish tank, a hydroponic system or any environment that has generally weak levels of acids and bases you will only need to recalibrate your probe once per year for the first two years. After that every ~six months.