

BEZEL P/N	VERSION	SLEEVE MATERIAL	ADAPTER COLOR
106004-3280	1 (ST-SC)	PHOSPHOR BRONZE	METAL
106004-3281	1 (ST-SC)	ZIRCONIA	
106004-3282	2 (FC-SC)	PHOSPHOR BRONZE	BLACK
106004-3283	2 (FC-SC)	ZIRCONIA	
106004-3284	3 (SC-SC)	PHOSPHOR BRONZE	RED
106004-3285	3 (SC-SC)	ZIRCONIA	
106004-3286	3 (SC-SC)	PHOSPHOR BRONZE	BLACK
106004-3287	3 (SC-SC)	ZIRCONIA	
106004-3288	4 (MTP-MTP)	N/A	METAL
106004-3290	1 (ST-SC)	PHOSPHOR BRONZE	
106004-3291	1 (ST-SC)	ZIRCONIA	BLACK
106004-3292	2 (FC-SC)	PHOSPHOR BRONZE	
106004-3293	2 (FC-SC)	ZIRCONIA	RED
106004-3294	3 (SC-SC)	PHOSPHOR BRONZE	
106004-3295	3 (SC-SC)	ZIRCONIA	BLACK
106004-3296	3 (SC-SC)	PHOSPHOR BRONZE	
106004-3297	3 (SC-SC)	ZIRCONIA	RED
106004-3298	4 (MTP-MTP)	N/A	
106004-3308	3 (SC-SC)	ZIRCONIA	GREEN

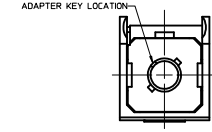

VIEW A  
VERSION 1 (ST-SC)  
DOOR REMOVED  
ROTATED 30° CW

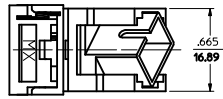
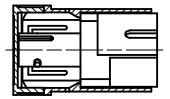

SECTION B-B  
VERSION 1 (ST-SC)  
ROTATED 30° CW

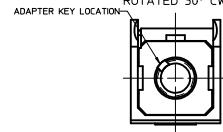

VIEW A  
VERSION 2 (FC-SC)  
DOOR REMOVED  
ROTATED 30° CW

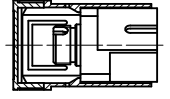

SECTION B-B  
VERSION 2 (FC-SC)  
ROTATED 30° CW

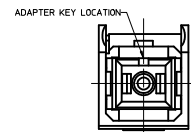

VIEW A  
VERSION 3 (SC-SC)  
DOOR REMOVED  
ROTATED 30° CW

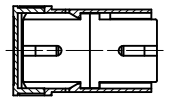

SECTION B-B  
VERSION 3 (SC-SC)  
ROTATED 30° CW

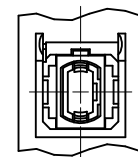

VIEW A  
VERSION 4 (MTP-MTP)  
DOOR REMOVED  
ROTATED 30° CW  
SEE NOTE 2

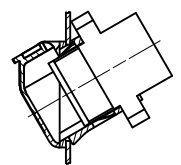

SECTION C-C  
VERSION 4 (MTP-MTP)  
SEE NOTE 2

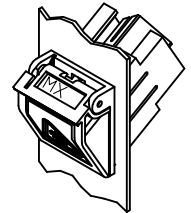
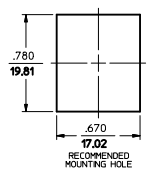
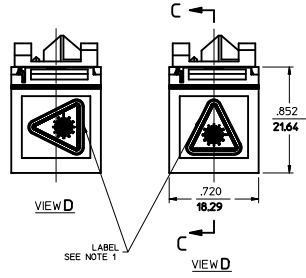
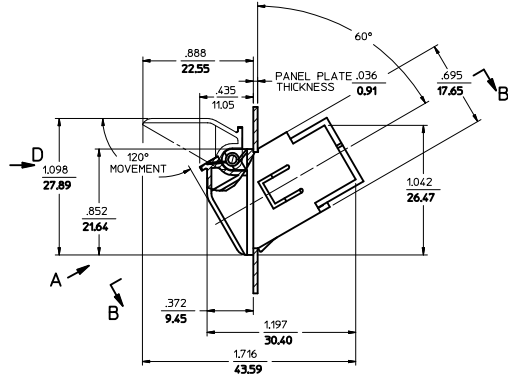

ISOMETRIC VIEW

NOTES:  
1. LABEL P/N 106004-3013 TO BE INSTALLED BY CUSTOMER.  
2. MTP-MTP ADAPTER (VERSION 4) TO BE ASSEMBLED BY CUSTOMER, AFTER BEZEL IS INSTALLED IN PANEL CUTOUT.

<b>ENTER DESCRIPTION</b> IEC NO: MF2010-0335 DRAWN: RFEVZNER CHYD: 2010/02/02 APPR: JGUMIN 2010/02/11	<b>QUALITY SYMBOLS</b> ▽=0 ▽=0	<b>GENERAL TOLERANCES (UNLESS SPECIFIED)</b> <table border="1"> <tr><th></th><th>mm</th><th>INCH</th></tr> <tr><td>4 PLACES</td><td>±.005</td><td>±.0005</td></tr> <tr><td>3 PLACES</td><td>±.005</td><td>±.0005</td></tr> <tr><td>2 PLACES</td><td>±.005</td><td>±.0005</td></tr> <tr><td>1 PLACE</td><td>±.005</td><td>±.0005</td></tr> </table>		mm	INCH	4 PLACES	±.005	±.0005	3 PLACES	±.005	±.0005	2 PLACES	±.005	±.0005	1 PLACE	±.005	±.0005	<b>DIMENSION STYLE</b> IN/MM	<b>SCALE</b> 2:1	<b>DESIGN UNITS</b> INCH	THIRD ANGLE PROJECTION
		mm	INCH																		
	4 PLACES	±.005	±.0005																		
	3 PLACES	±.005	±.0005																		
2 PLACES	±.005	±.0005																			
1 PLACE	±.005	±.0005																			
<b>APPROVED BY</b> JGUMIN 2010/02/02	<b>DATE</b> 2010/02/02	<b>TITLE</b> SIMPLEX BEZEL ADAPTER KITS	<b>MOLEX INCORPORATED</b>																		
<b>DRAFT WHERE APPLICABLE MUST REMAIN WITHIN DIMENSIONS</b>	<b>SEE TABLE</b>	<b>DOCUMENT NO.</b> SD-106004-32XX	<b>SHEET NO.</b> 1 OF 01	<b>THIS DRAWING CONTAINS INFORMATION THAT IS PROPRIETARY TO MOLEX INCORPORATED AND SHOULD NOT BE USED WITHOUT WRITTEN PERMISSION</b>																	
<b>REV</b>	<b>DESCRIPTION</b>	<b>SIZE</b> D	<b>SIZE</b>																		