

DESCRIPTION

The MP24830 is a 90V, white LED driver suitable for inverting step-up/down applications. It supports a wide input range with excellent load and line regulation. Its programmable current limit provides customized applications with wide power range. Current mode operation provides fast transient response and eases loop stabilization. Fault condition protection includes thermal shutdown, cycle-by-cycle peak current limiting, open strings protection and output short circuit protection.

The MP24830 incorporates both DC and PWM dimming onto a single control pin. The separate input reference ground pin allows for direct enable and/or dimming control for a positive to negative power conversion

ELECTRICAL SPECIFICATION

Parameter	Symbol	Value	Units
Input Voltage	V _{IN}	5 To (V _{IN} +V _{OUT})<80	V
Enable Voltage	V _{EN}	5	V
LED Current	I _{LED}	1	A
Switching Frequency	F _S	200	kHz
Output Voltage Protection	V _{OVP}	28	V

FEATURES

- Programmable Maximum Output Current
- Unique Operation (Buck-Boost Mode)
- Wide 5V to 90V Operating Input Range
- Adjustable Switching Frequency
- Analog and PWM Dimming
- 0.2V Reference Voltage
- 5µA Shutdown Mode
- No Minimum LED Required
- Stable with Low ESR Output Ceramic Capacitors
- Cycle-by-Cycle Over Current Protection
- Thermal Shutdown Protection
- Open Strings Protection
- Output Short Circuit Protection
- Available in 14-Pin SOIC14

APPLICATIONS

- General LED Illuminations
- Automotive LED Lighting
- TV Backlighting System
- LCD Backlight Panels
- Handheld Computers

All MPS parts are lead-free and adhere to the RoHS directive. For MPS green status, please visit MPS website under Products, Quality Assurance page.

"MPS" and "The Future of Analog IC Technology" are registered trademarks of Monolithic Power Systems, Inc.

ADAM (Analog Digital Adaptive Modulation) and AAM (Advanced Asynchronous Mode) are trademarks of Monolithic Power Systems, Inc.

EV24830-S-00A EVALUATION BOARD

TBD

(L x W x H) 6.4cm x 6.4cm x 1.3cm

EV24830-S-00A	MP24830
---------------	---------

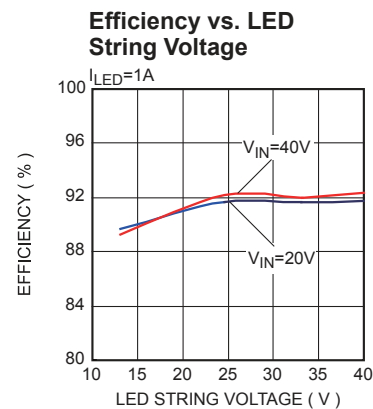

EVALUATION BOARD SCHEMATIC

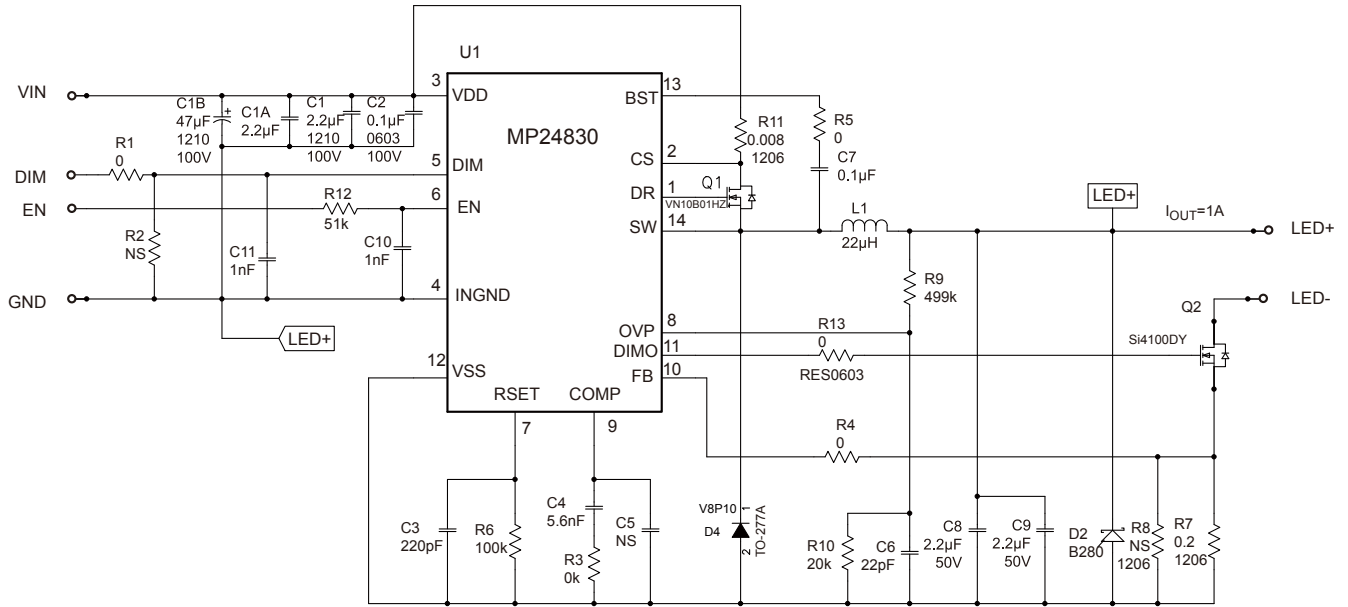

EV24830-S-00A BILL OF MATERIALS

Qty	RefDes	Value	Description	Package	Manufacturer	Manufacturer P/N
3	C1,C1A, C8	2.2μF	Ceramic Cap., 100V, 10%, X7R	1210	muRata	GRM32ER72A225K
1	C1B	47μF	Alu Cap., 100V, 10%,	8 x 12 x 3.5	Panasonica	ECA-2AM470
1	C2	0.1μF	Ceramic Cap., 100V, 10%, X7R	0603	muRata	GRM188R72A104KA35D
1	C3	220pF	Ceramic Cap., 50V, 10%, X7R	0603	muRata	GRM188R71H221KA01D
1	C4	5.6nF	Ceramic Cap., 50V, 10%, X7R	0603	muRata	GRM188R71H562KA01D
	C5, C9	NS				
1	C6	22pF	Ceramic Cap., 50V, 5%, C0G	0603	muRata	GRM1885C1H220JA01D
1	C7	0.1μF	Ceramic Cap., 50V, 10%, X7R	0603	muRata	GRM188R71E104KA01D
2	C10, C11	1nF	Ceramic Cap., 50V, 10%, X7R	0603	muRata	GRM188R71H102KA01D
	D1	NS		TO-220		
1	D2	1A	Schottky Rect., 100V, 1A	SMA	ST	STPS1100A
1	D3	8A	Schottky Rect., 100V, 8A	SMC	Vishay	V8P10
1	L1	22μH	Inductor, Rdc 15mΩ, Isat 11A	SMD	Würth Elektronik	74435572200
5	R1, R3, R4, R5, R13	0	Film Res., 5%	0603	Yageo	RC0603JR-070RL
	R2	NS		0603		
1	R6	100kΩ	Film Res., 1%	0603	Yageo	9C06031A1003FKHFT
1	R7	200mΩ	Film Res.1/2W, 1%	1206	Cyntec	RLT1632-4-R200-FNH
	R8	NS		1206		
1	R9	499kΩ	Film Res., 1%	0603	Yageo	9C06031A4993FKHFT
1	R10	20k	Film Res., 1%	0603	Yageo	9C06031A2002FKHFT
1	R11	8mΩ	Film Res., 1/2W, 1%	1206	Cyntec	RL1632H-R008-FNH
1	R12	51k	Film Res., 5%	0603	Yageo	9C06031A5102FKHFT
1	Q1	N-MOS	100V Mosfet FDD86102	D-Pak	Fairchild	FDD86102
1	Q2	N-MOS	100V Mosfet Si4100DY	SO-8	Vishay	Si4100DY
	Q3	NS		TO-220		
1	U1	MP24830	Power Led Driver	SO14DS	MPS	MP24830HS(R2)
1	EN,DIM,G ND		3 Pin Header, 2.54mm	2.54mm	Sullins	PCC03SAAN
4	LED+,LED- ,VIN,GND		2.3 pillar	W200D100	HZ	China
2	JP1, JP2		Jumper		HZ	China

EVB TEST RESULTS

Performance waveforms are tested on the evaluation board.

$V_{EN}=5V$, $V_{IN}=12V$, $I_{OUT}=1A$, $L=22\mu H$, $T_A=25^\circ C$, Unless otherwise noted.

Efficiency vs. Input Voltage

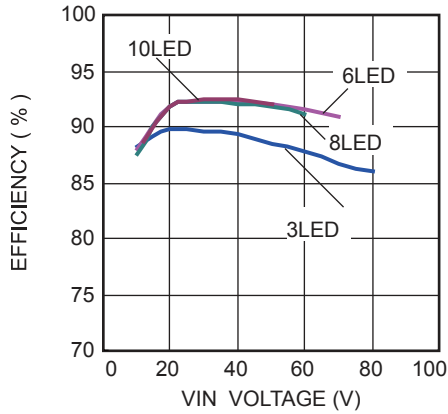

Efficiency vs. LED String Voltage

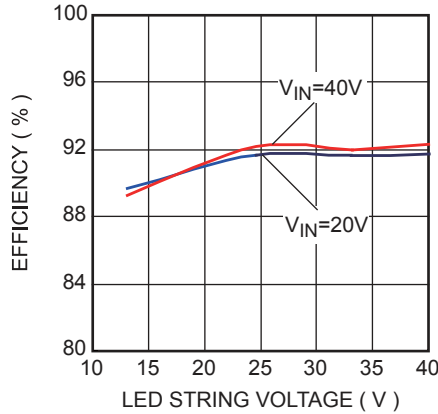

I_{LED} Line Regulation vs. VIN

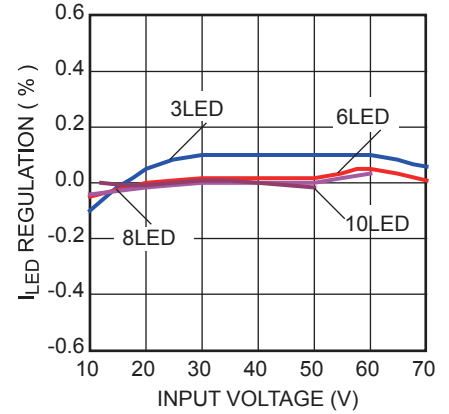

I_{LED} vs. PWM Dimming

$V_{IN}=25V$, 3LED, $F_{DIM}=0.2kHz$

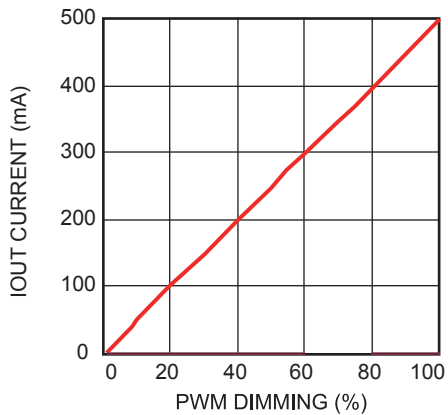

I_{LED} vs. Analog Dimming

$V_{IN}=20V$, 3LED, $I_{OUT}=1A$, $F_{DIM}=0.2kHz$

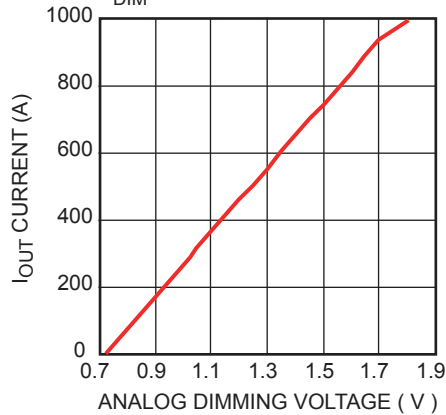

EVB TEST RESULTS (continued)

Performance waveforms are tested on the evaluation board.

$V_{EN}=5V$, $V_{IN}=12V$, $I_{OUT}=1A$, $L=22\mu H$, $T_A=25^\circ C$, Unless otherwise noted.

Steady State

$V_{IN}=8V$, 3LED, $I_{OUT}=1A$

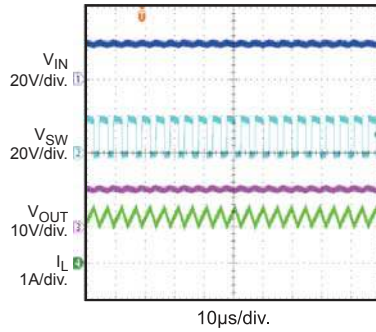

PWM Dimming

$V_{IN}=25V$, 3LED, $F_{DIM}=200Hz/50\%$

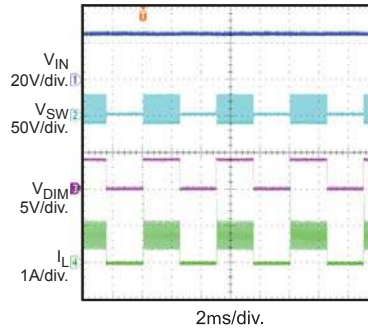

Analog Dimming

$V_{IN}=25V$, 3LED, $V_{DIM}=0.9V$

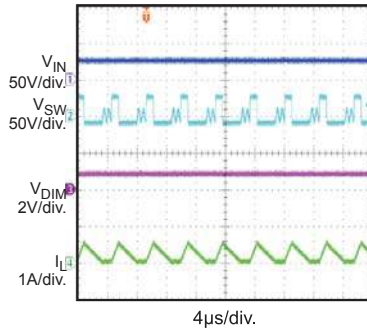

Power Ramp Up

$V_{IN}=8V$, 3LED

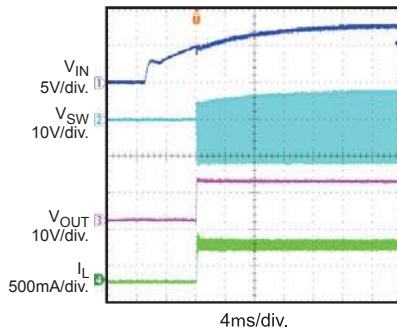

Open LED Protection

$V_{IN}=25V$, 3LED, $I_{LED}=1A$

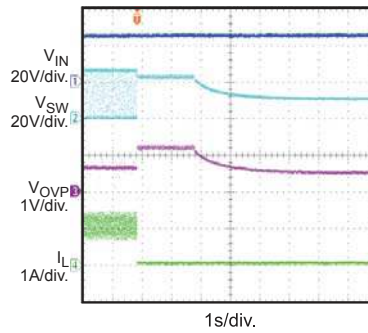

Enable Power Up

$V_{IN}=25V$, 3LED

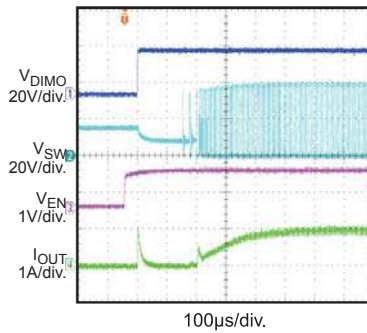

Enable Power Down

$V_{IN}=25V$, 3LED

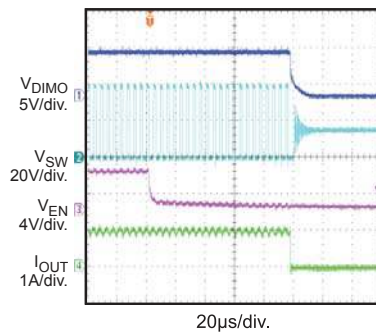

Short LED Protection

$V_{IN}=16V$, 3LED

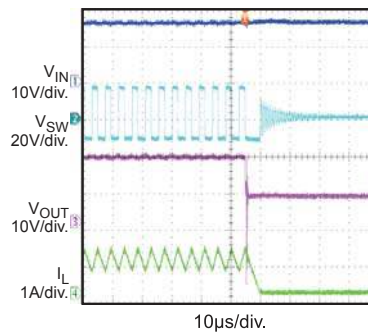

Short LED To VSS

$V_{IN}=25V$, 3LED

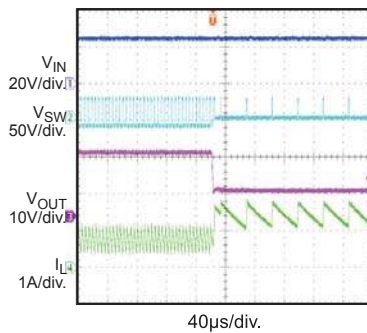

PRINTED CIRCUIT BOARD LAYOUT

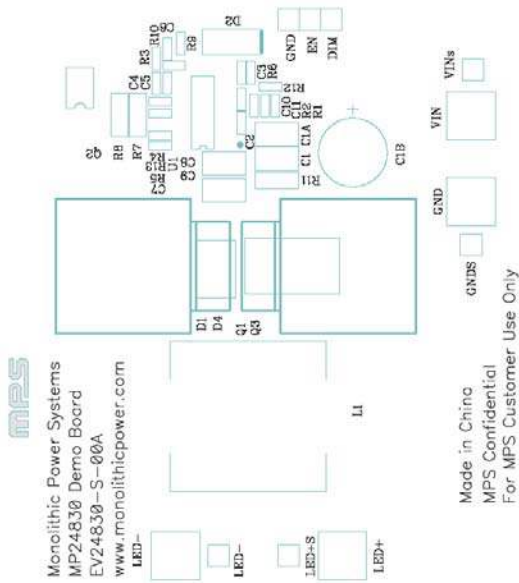

Figure 1—Top Silk Layer

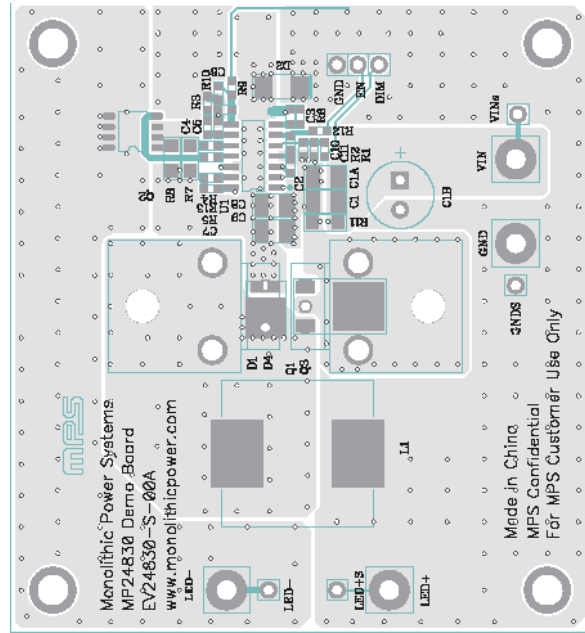

Figure 2—Top Layer

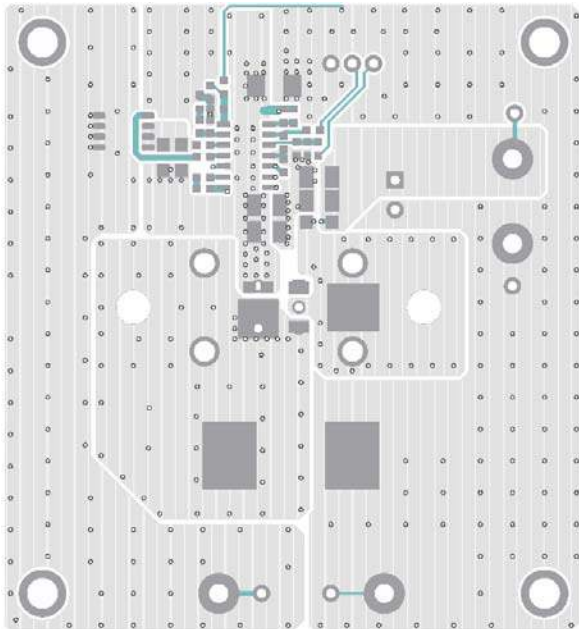

Figure 3—Top Layer

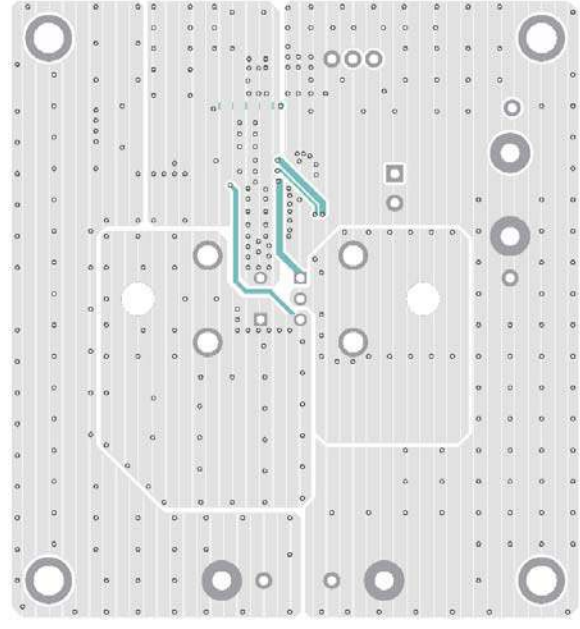

Figure 4—Bottom Layer

QUICK START GUIDE

1. Connect the LED string between “LED+” (anode of LED string) and “LED-“(cathode of LED string). The LED string voltage should be Less than 28V (7 LED string voltage is about 25V), since the output voltage protection is about 28V.
2. Set a VIN power supply voltage (range from 5V to $V_{IN}+V_{OUT} < 80V$) and connect the input between the “VIN” and “INGND” terminals as shown in the EVB board.
3. Set a second power supply 5V as the EN input supply to the EVB.
4. Turn-off all power supplies.
5. Turn-on the input voltage power supply.
6. Turn on the 5V EN power supply. All the LED strings should be lighted.
7. The switching frequency was set by R6, which is about 200kHz.
8. To demo the dimming function on DIM connector: using a function generator set the PWM signal amplitude to 5V and the frequency within 100Hz to 20kHz range for PWM dimming. For analog dimming, adjust the power supply from 0.7V to 2V.

NOTICE: The information in this document is subject to change without notice. Please contact MPS for current specifications. Users should warrant and guarantee that third party Intellectual Property rights are not infringed upon when integrating MPS products into any application. MPS will not assume any legal responsibility for any said applications.