

**NOTES:**

1. Material : Music Wire
2. Finish : Glod Irridite
3. Ends : Closed
4. Total Coils : 10.000
5. Sugg. Max. Deflection : 0.280 (in)
6. Sugg. Max. Load : 2.300 (lbs)
7. All Drawing Dimensions are in Inches [mm]

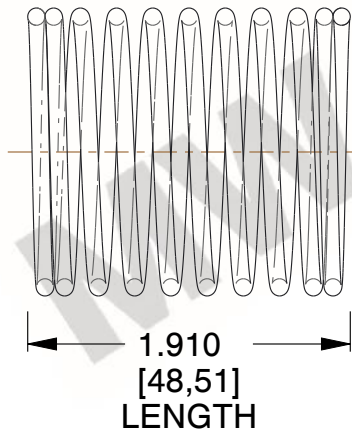

$\varnothing$  0.030  
 [0,76]  
 WIRE DIA



$\varnothing$  0.500  
 [12,70]  
 O.D

$\varnothing$  0.440  
 [11,18]  
 I.D

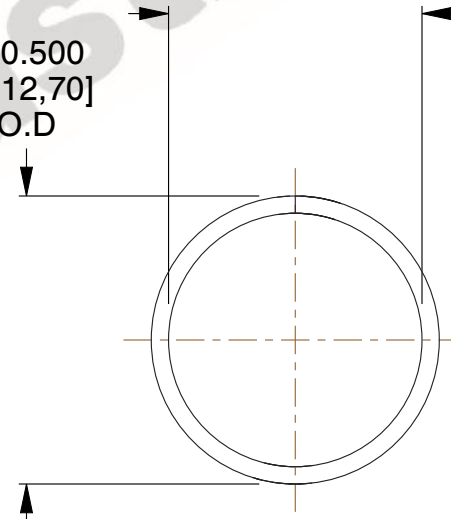

COMPONENT		SPRINGS	
<b>11772</b>  COMPRESSION SPRINGS		UNIT	INCH [mm]
		SHEET	1 of 1