

DO NOT SCALE FROM THIS PRINT

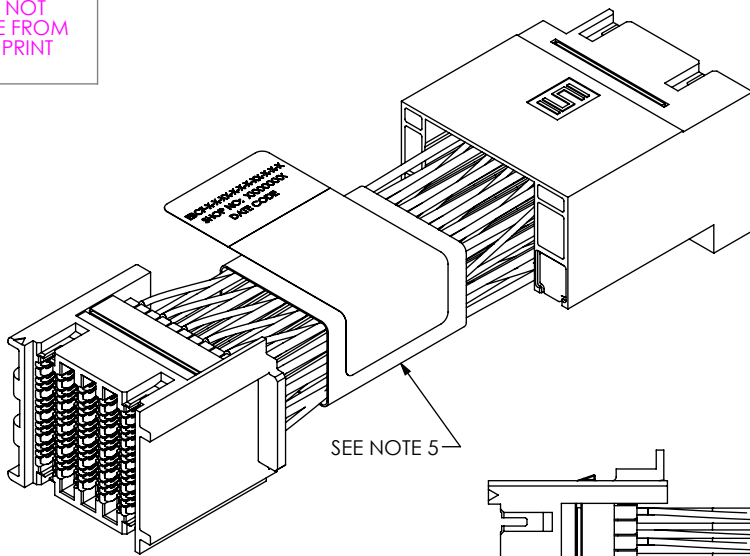

SEE NOTE 5

- CABLE STYLE AND SIGNAL MAP**
 -1: 34AWG TwinAx 100OHM, TX TO RX SIGNAL MAP
 -2: 30AWG TwinAx 100OHM, TX TO RX SIGNAL MAP
 -3: 34AWG TwinAx 100OHM, 1:1 SIGNAL MAP
 -4: 30AWG TwinAx 100OHM, 1:1 SIGNAL MAP
 *5: 34AWG TwinAx 92.5OHM, TX TO RX SIGNAL MAP
 *-6: 34AWG ThinAx 92.5OHM, TX TO RX SIGNAL MAP
 *-7: 34AWG TwinAx 92.5OHM, 1:1 SIGNAL MAP
 *-8: 34AWG ThinAx 92.5OHM, 1:1 SIGNAL MAP

PAIRS PER COLUMN
-4

COLUMNS
 ***-04, -06, -08, -10, ***-12, ***-14, ***-16

END 1
-V: VERTICAL LATCH

END 1 PIN CONFIGURATION
 -1: STANDARD
 *-2: ADVANCED MATE
 *-3: SHORT DETECT
 *-4: ADVANCED MATE AND SHORT DETECT

END 2 KEY
 (-R END OPTION ONLY)
 -A THRU -H: POSITION OF FLAT ON KEY
 BLANK: NO KEY

END 2 GUIDE
 (-R END OPTION ONLY)
 -L: LEFT GUIDE
 -R: RIGHT GUIDE

END 2 PIN CONFIGURATION
 -1: STANDARD
 *-2: ADVANCED MATE
 *-3: SHORT DETECT
 *-4: ADVANCED MATE AND SHORT DETECT

END 2 OPTION
 -V: VERTICAL LATCH
 **R: RIGHT ANGLE

CABLE LENGTH
 -XX (INCHES)
 (06 INCHES MINIMUM, SEE NOTE 3)

(* = NOT TOOLED)
 (** = NOT TOOLED FOR -04 & -06 COLUMNS)
 (***) = SEE NOTE 7)

TABLE 1			
COLUMNS	"A"	"B"	"C"
-04	10.60 [.417]	19.15 [.754]	14.85 [.585]
-06	14.60 [.575]	23.15 [.911]	18.85 [.742]
-08	18.60 [.732]	27.15 [1.069]	22.85 [.900]
-10	22.60 [.890]	31.15 [1.226]	26.85 [1.057]
-12	26.60 [1.047]	35.15 [1.384]	30.85 [1.215]
-14	30.60 [1.205]	39.15 [1.541]	34.85 [1.372]
-16	34.60 [1.362]	43.15 [1.699]	38.85 [1.530]

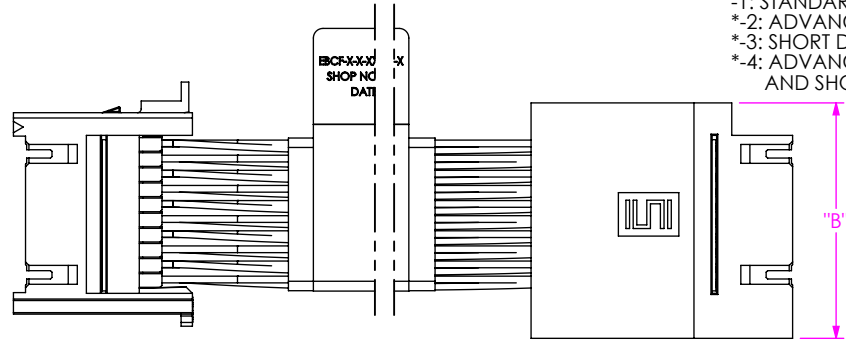

"B"

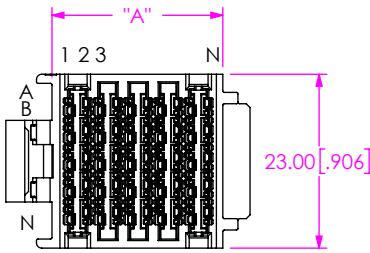

23.00 [.906]

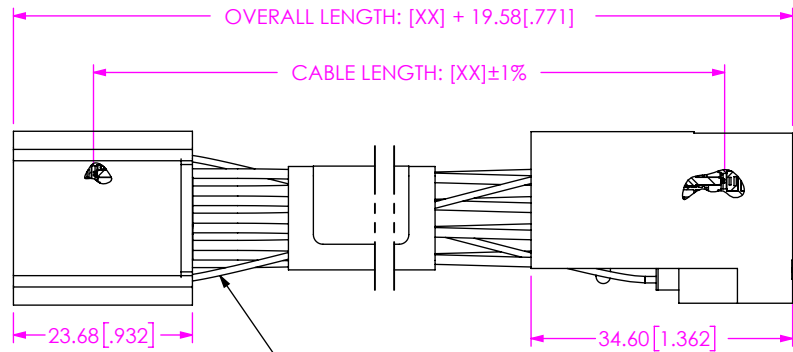

OVERALL LENGTH: [XX] + 19.58 [.771]

CABLE LENGTH: [XX] ± 1%

23.68 [.932]

34.60 [1.362]

SEE NOTE 4

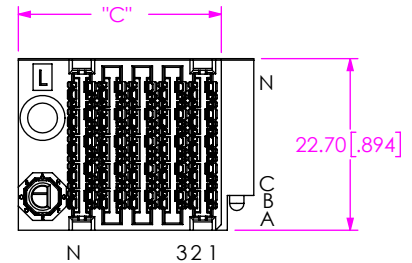

22.70 [.894]

N 32 1

END 1

END 2

FIG 1
EBCF-X-4-10-V-1-XX-R-1-L-G SHOWN

NOTES:

1. ALL ASSEMBLIES TO BE 100% HI-POT TESTED AT 300V.
2. ALL ASSEMBLIES TO BE 100% ELECTRICALLY TESTED FOR SHORTS AND OPENS.
3. CABLE LENGTHS LONGER THAN 40 INCHES ARE NOT SUPPORTED BY S.I. TEST DATA.
4. LSX WIRE TO BE 34 AWG CO-AX STANDARD.
5. EBCF COMES STANDARD WITH SRS CABLE SLEEVING.
6. NOTE DELETED.
7. CONTACT SAMTEC, CONFIGURATION NOT STANDARD.

PROPRIETARY NOTE
 THIS DOCUMENT CONTAINS CONFIDENTIAL AND PROPRIETARY INFORMATION AND ALL DESIGN, MANUFACTURING, REPRODUCTION, USE, PATENT RIGHTS AND SALES RIGHTS ARE EXPRESSLY RESERVED BY SAMTEC, INC. THIS DOCUMENT SHALL NOT BE DISCLOSED, IN WHOLE OR PART, TO ANY UNAUTHORIZED PERSON OR ENTITY NOR REPRODUCED, TRANSFERRED OR INCORPORATED IN ANY OTHER PROJECT IN ANY MANNER WITHOUT THE EXPRESS WRITTEN CONSENT OF SAMTEC, INC.

DO NOT SCALE DRAWING
 SHEET SCALE: 1:1
 MATERIAL:
 INSULATOR: LCP
 SIGNAL & GROUND PINS: COPPER ALLOY
 PLATING: 30µ" SELECTIVE GOLD IN CONTACT AREA

samtec
 520 PARK EAST BLVD, NEW ALBANY, IN 47150
 PHONE: 812-944-6733 FAX: 812-948-5047
 e-Mail: info@SAMTEC.com code 55322

DESCRIPTION:
EXAMAX BACKPLANE CABLE
 DWG. NO.
EBCF-X-4-XX-V-X-XX-X-X-X-X

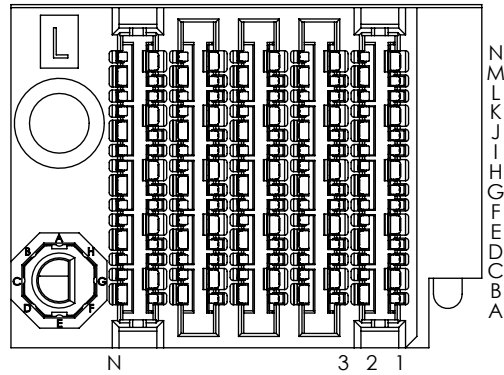
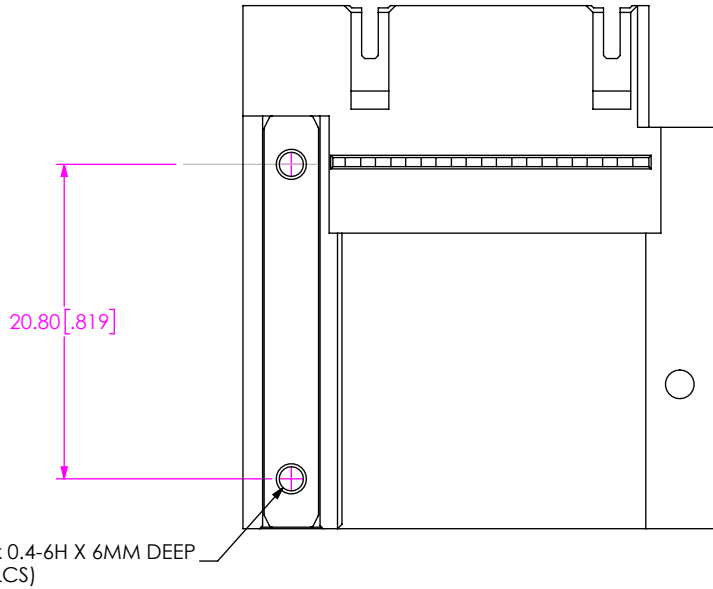

FIG 2
END 2, -R-1-L-G SHOWN



F:\DWG\MISC\MKTG\EBCF-X-4-XX-V-X-XX-X-X-X-MKT.SLDDRW

PROPRIETARY NOTE
 THIS DOCUMENT CONTAINS CONFIDENTIAL AND PROPRIETARY INFORMATION AND ALL DESIGN, MANUFACTURING, REPRODUCTION, USE, PATENT RIGHTS AND SALES RIGHTS ARE EXPRESSLY RESERVED BY SAMTEC, INC. THIS DOCUMENT SHALL NOT BE DISCLOSED, IN WHOLE OR PART, TO ANY UNAUTHORIZED PERSON OR ENTITY NOR REPRODUCED, TRANSFERRED OR INCORPORATED IN ANY OTHER PROJECT IN ANY MANNER WITHOUT THE EXPRESS WRITTEN CONSENT OF SAMTEC, INC.

samtec
 520 PARK EAST BLVD, NEW ALBANY, IN 47150
 PHONE: 812-944-6733 FAX: 812-948-5047
 e-Mail info@SAMTEC.com code 55322

DO NOT SCALE DRAWING

SHEET SCALE: 1:75:1

DESCRIPTION:
 EXAMAX BACKPLANE CABLE

DWG. NO.
EBCF-X-4-XX-V-X-XX-X-X-X-X

BY: CANDY W 06/16/2017 SHEET 2 OF 6

TABLE 2

GUIDANCE	KEYING							
	-A	-B	-C	-D	-E	-F	-G	-H
-R / -L								

END 1 ORIENTATION

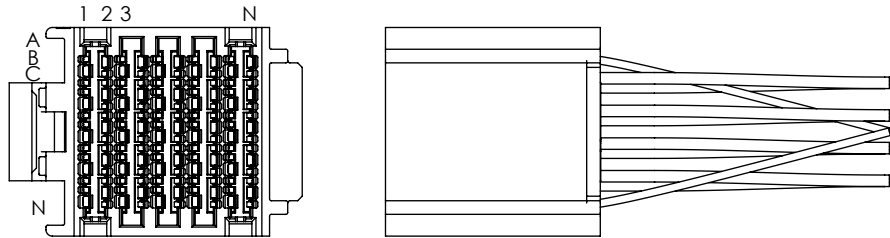

END 2 ORIENTATIONS

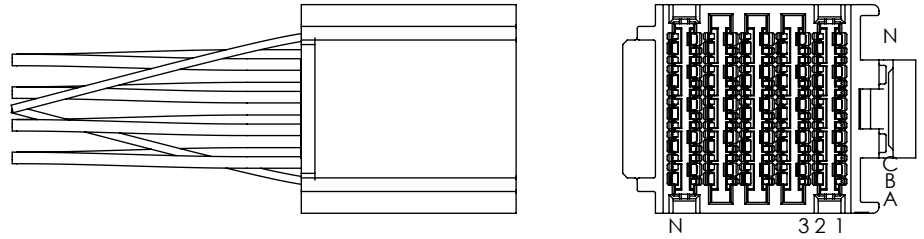

EBCF-X-4-10-V-1-XX-V-1 SHOWN

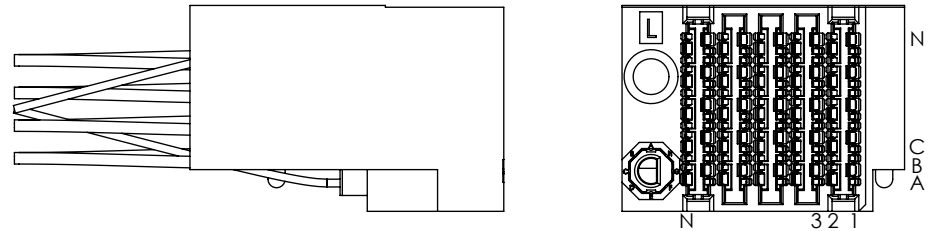

EBCF-X-4-10-V-1-XX-R-1-L-G SHOWN

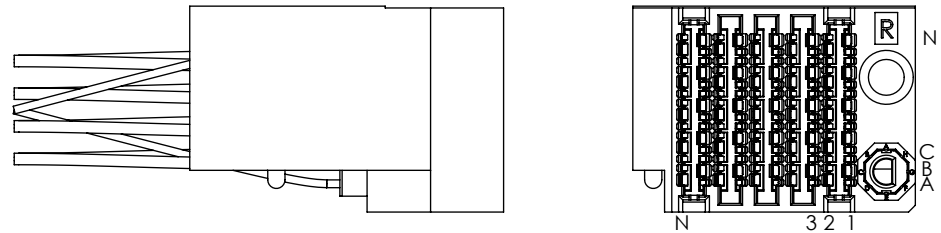

EBCF-X-4-10-V-1-XX-R-1-R-G SHOWN

PROPRIETARY NOTE
 THIS DOCUMENT CONTAINS CONFIDENTIAL AND PROPRIETARY INFORMATION AND ALL DESIGN, MANUFACTURING, REPRODUCTION, USE, PATENT RIGHTS AND SALES RIGHTS ARE EXPRESSLY RESERVED BY SAMTEC, INC. THIS DOCUMENT SHALL NOT BE DISCLOSED, IN WHOLE OR PART, TO ANY UNAUTHORIZED PERSON OR ENTITY NOR REPRODUCED, TRANSFERRED OR INCORPORATED IN ANY OTHER PROJECT IN ANY MANNER WITHOUT THE EXPRESS WRITTEN CONSENT OF SAMTEC, INC.

DO NOT SCALE DRAWING

SHEET SCALE: 1.2:1



520 PARK EAST BLVD, NEW ALBANY, IN 47150
 PHONE: 812-944-6733 FAX: 812-948-5047
 e-Mail info@SAMTEC.com code 55322

DESCRIPTION: EXAMAX BACKPLANE CABLE

DWG. NO. EBCF-X-4-XX-V-X-XX-X-X-X-X

BY: CANDY W 06/16/2017 SHEET 3 OF 6

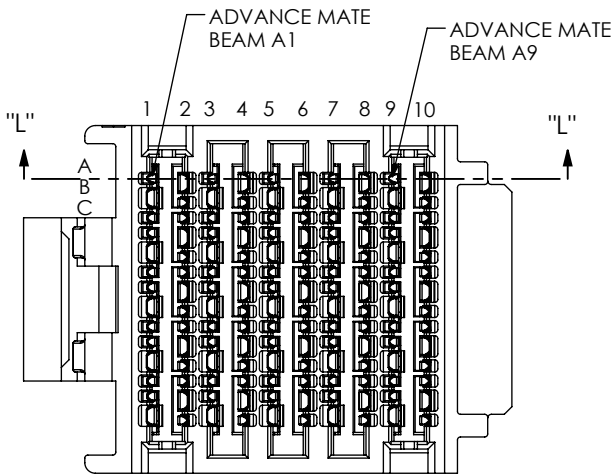
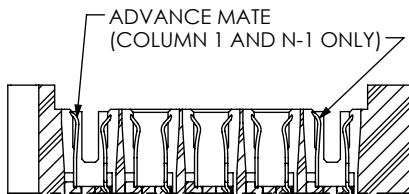

FIG 3
 ADVANCED MATE
 EBCF-X-4-10-V-2 SHOWN
 (DIFFERENT AS SHOWN, OTHERWISE SAME AS FIG 1)
 (NOT TOOLED)



SECTION "L"-"L"
 SCALE 2 : 1

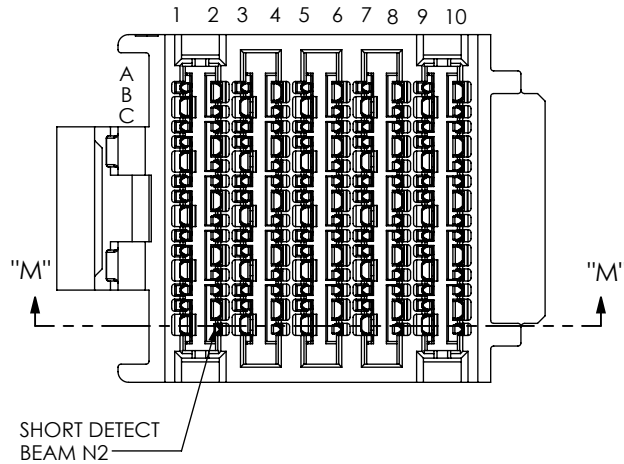
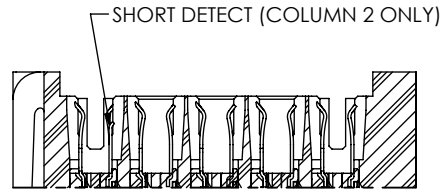

FIG 4
 SHORT DETECT
 EBCF-X-4-10-V-3 SHOWN
 (DIFFERENT AS SHOWN, OTHERWISE SAME AS FIG 1)
 (NOT TOOLED)



SECTION "M"-"M"
 SCALE 2 : 1

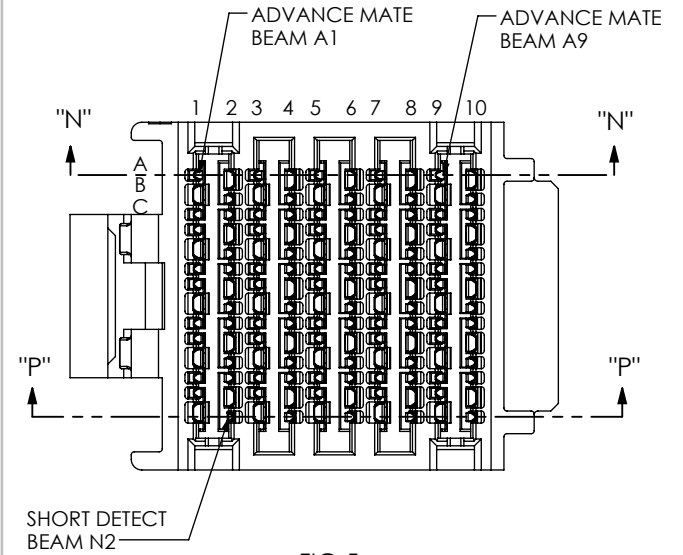
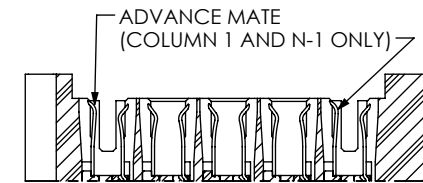
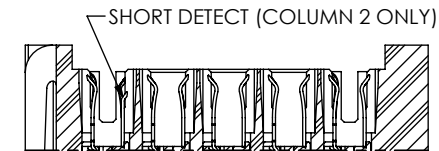

FIG 5
 ADVANCED MATE AND SHORT DETECT
 EBCF-X-4-10-V-2 SHOWN
 (DIFFERENT AS SHOWN, OTHERWISE SAME AS FIG 3 & 4)
 (NOT TOOLED)



SECTION "N"-"N"
 SCALE 2 : 1



SECTION "P"-"P"
 SCALE 2 : 1

PROPRIETARY NOTE
 THIS DOCUMENT CONTAINS CONFIDENTIAL AND PROPRIETARY INFORMATION AND ALL DESIGN, MANUFACTURING, REPRODUCTION, USE, PATENT RIGHTS AND SALES RIGHTS ARE EXPRESSLY RESERVED BY SAMTEC, INC. THIS DOCUMENT SHALL NOT BE DISCLOSED, IN WHOLE OR PART, TO ANY UNAUTHORIZED PERSON OR ENTITY NOR REPRODUCED, TRANSFERRED OR INCORPORATED IN ANY OTHER PROJECT IN ANY MANNER WITHOUT THE EXPRESS WRITTEN CONSENT OF SAMTEC, INC.



520 PARK EAST BLVD, NEW ALBANY, IN 47150
 PHONE: 812-944-6733 FAX: 812-948-5047
 e-Mail info@SAMTEC.com code 55322

DO NOT SCALE DRAWING

SHEET SCALE: 1:1

DESCRIPTION:
 EXAMAX BACKPLANE CABLE

DWG. NO.
EBCF-X-4-XX-V-X-XX-X-X-X-X

BY: CANDY W 06/16/2017 SHEET 4 OF 6

ROW	4 PAIR PIN-OUT															
	1	2	3	4	5	6	7	8	9	10	11	12	13	14	15	16
A	LS1	GND	LS3	GND	LS5	GND	LS7	GND	LS9	GND	LS11	GND	LS13	GND	LS15	GND
B	GND	TX3+	GND	TX7+	GND	TX11+	GND	TX15+	GND	TX19+	GND	TX23+	GND	TX27+	GND	TX31+
C	TX1+	TX3-	TX5+	TX7-	TX9+	TX11-	TX13+	TX15-	TX17+	TX19-	TX21+	TX23-	TX25+	TX27-	TX29+	TX31-
D	TX1-	GND	TX5-	GND	TX9-	GND	TX13-	GND	TX17-	GND	TX21-	GND	TX25-	GND	TX29-	GND
E	GND	TX4+	GND	TX8+	GND	TX12+	GND	TX16+	GND	TX20+	GND	TX24+	GND	TX28+	GND	TX32+
F	TX2+	TX4-	TX6+	TX8-	TX10+	TX12-	TX14+	TX16-	TX18+	TX20-	TX22+	TX24-	TX26+	TX28-	TX30+	TX32-
G	TX2-	GND	TX6-	GND	TX10-	GND	TX14-	GND	TX18-	GND	TX22-	GND	TX26-	GND	TX30-	GND
H	GND	RX4-	GND	RX8-	GND	RX12-	GND	RX16-	GND	RX20-	GND	RX24-	GND	RX28-	GND	RX32-
I	RX2-	RX4+	RX6-	RX8+	RX10-	RX12+	RX14-	RX16+	RX18-	RX20+	RX22-	RX24+	RX26-	RX28+	RX30-	RX32+
J	RX2+	GND	RX6+	GND	RX10+	GND	RX14+	GND	RX18+	GND	RX22+	GND	RX26+	GND	RX30+	GND
K	GND	RX3-	GND	RX7-	GND	RX11-	GND	RX15-	GND	RX19-	GND	RX23-	GND	RX27-	GND	RX31-
L	RX1-	RX3+	RX5-	RX7+	RX9-	RX11+	RX13-	RX15+	RX17-	RX19+	RX21-	RX23+	RX25-	RX27+	RX29-	RX31+
M	RX1+	GND	RX5+	GND	RX9+	GND	RX13+	GND	RX17+	GND	RX21+	GND	RX25+	GND	RX29+	GND
N	GND	LS2	GND	LS4	GND	LS6	GND	LS8	GND	LS10	GND	LS12	GND	LS14	GND	LS16
	1	2	3	4	5	6	7	8	9	10	11	12	13	14	15	16
WAFER	B	A	B	A	B	A	B	A	B	A	B	A	B	A	B	A

4 PAIR SIGNAL MAPPING FOR -1 AND -2 SIGNAL MAP OPTIONS

"B" WAFERS (ODD NUMBER COLUMNS)				"A" WAFERS (EVEN NUMBER COLUMNS)				
END 1		PAIR	END 2		END 1		END 2	
POSITION	SYMBOL		POSITION	SYMBOL	POSITION	SYMBOL	POSITION	SYMBOL
A1	LS1	PAIR	A1	LS1	A2	GND	M2	GND
B1	GND		N1	GND	B2	TX3+	L2	RX3+
C1	TX1+	PAIR	M1	RX1+	C2	TX3-	K2	RX3-
D1	TX1-		L1	RX1-	D2	GND	J2	GND
E1	GND	PAIR	K1	GND	E2	TX4+	I2	RX4+
F1	TX2+		J1	RX2+	F2	TX4-	H2	RX4-
G1	TX2-	PAIR	I1	RX2-	G2	GND	G2	GND
H1	GND		H1	GND	H2	RX4-	F2	TX4-
I1	RX2-	PAIR	G1	TX2-	I2	RX4+	E2	TX4+
J1	RX2+		F1	TX2+	J2	GND	D2	GND
K1	GND	PAIR	E1	GND	K2	RX3-	C2	TX3-
L1	RX1-		D1	TX1-	L2	RX3+	B2	TX3+
M1	RX1+	PAIR	C1	TX1+	M2	GND	A2	GND
N1	GND		B1	GND	N2	LS2	N2	LS2

ALL GROUNDS ARE COMMON AND TIED TO CABLE SHIELD

4 PAIR SIGNAL MAPPING FOR -3 AND -4 SIGNAL MAP OPTIONS

"B" WAFERS (ODD NUMBER COLUMNS)				"A" WAFERS (EVEN NUMBER COLUMNS)				
END 1		PAIR	END 2		END 1		END 2	
POSITION	SYMBOL		POSITION	SYMBOL	POSITION	SYMBOL	POSITION	SYMBOL
A1	LS1	PAIR	A1	LS1	A2	GND	A2	GND
B1	GND		B1	GND	B2	TX3+	B2	TX3+
C1	TX1+	PAIR	C1	TX1+	C2	TX3-	C2	TX3-
D1	TX1-		D1	TX1-	D2	GND	D2	GND
E1	GND	PAIR	E1	GND	E2	TX4+	E2	TX4+
F1	TX2+		F1	TX2+	F2	TX4-	F2	TX4-
G1	TX2-	PAIR	G1	TX2-	G2	GND	G2	GND
H1	GND		H1	GND	H2	RX4-	H2	RX4-
I1	RX2-	PAIR	I1	RX2-	I2	RX4+	I2	RX4+
J1	RX2+		J1	RX2+	J2	GND	J2	GND
K1	GND	PAIR	K1	GND	K2	RX3-	K2	RX3-
L1	RX1-		L1	RX1-	L2	RX3+	L2	RX3+
M1	RX1+	PAIR	M1	RX1+	M2	GND	M2	GND
N1	GND		N1	GND	N2	LS2	N2	LS2

ALL GROUNDS ARE COMMON AND TIED TO CABLE SHIELD

PROPRIETARY NOTE
 THIS DOCUMENT CONTAINS CONFIDENTIAL AND PROPRIETARY INFORMATION AND ALL DESIGN, MANUFACTURING, REPRODUCTION, USE, PATENT RIGHTS AND SALES RIGHTS ARE EXPRESSLY RESERVED BY SAMTEC, INC. THIS DOCUMENT SHALL NOT BE DISCLOSED, IN WHOLE OR PART, TO ANY UNAUTHORIZED PERSON OR ENTITY NOR REPRODUCED, TRANSFERRED OR INCORPORATED IN ANY OTHER PROJECT IN ANY MANNER WITHOUT THE EXPRESS WRITTEN CONSENT OF SAMTEC, INC.



520 PARK EAST BLVD, NEW ALBANY, IN 47150
 PHONE: 812-944-6733 FAX: 812-948-5047
 e-Mail info@SAMTEC.com code 55322

DO NOT SCALE DRAWING

SHEET SCALE: 1:1

DESCRIPTION:
 EXAMAX BACKPLANE CABLE

DWG. NO.
EBCF-X-4-XX-V-X-XX-X-X-X-X

BY: CANDY W 06/16/2017 SHEET 5 OF 6

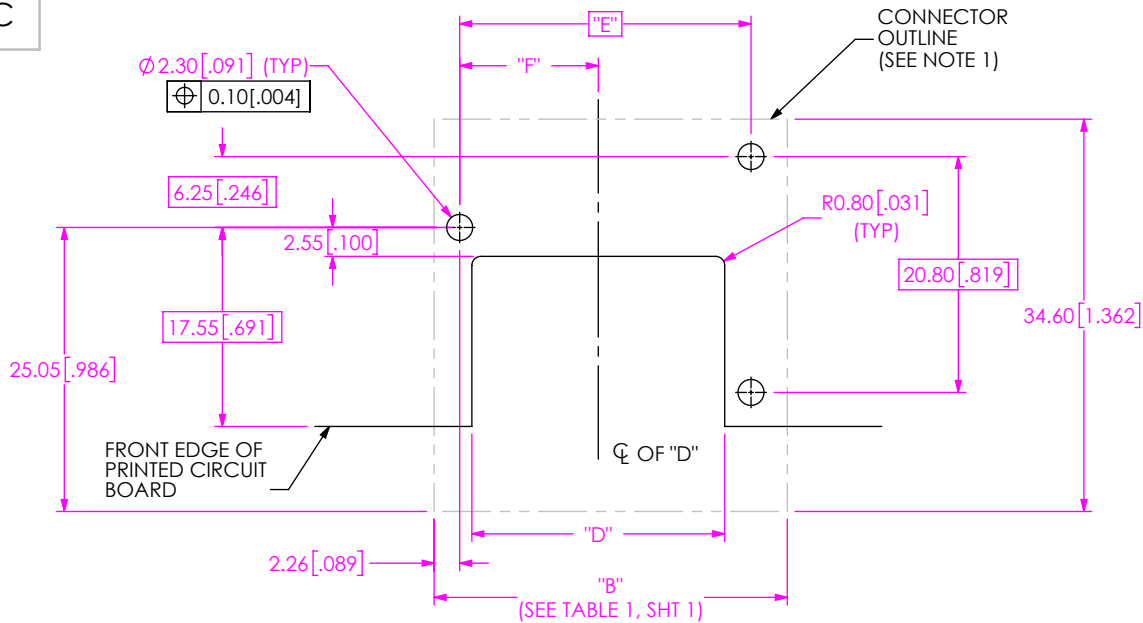

FIG 6
PCB CUTOUT FOR END 2, RIGHT GUIDANCE
EBCF-X-4-10-V-X-XX-R-X-R-X SHOWN

TABLE 3			
COLUMNS	"D"	"E"	"F"
-04	10.30 [.406]	13.70 [.539]	6.23 [.245]
-06	14.30 [.563]	17.70 [.697]	8.23 [.324]
-08	18.30 [.720]	21.70 [.854]	10.23 [.403]
-10	22.30 [.878]	25.70 [1.012]	12.23 [.481]
-12	26.30 [1.035]	29.70 [1.169]	14.23 [.560]
-14	30.30 [1.193]	33.70 [1.327]	16.23 [.639]
-16	34.30 [1.350]	37.70 [1.484]	18.23 [.718]

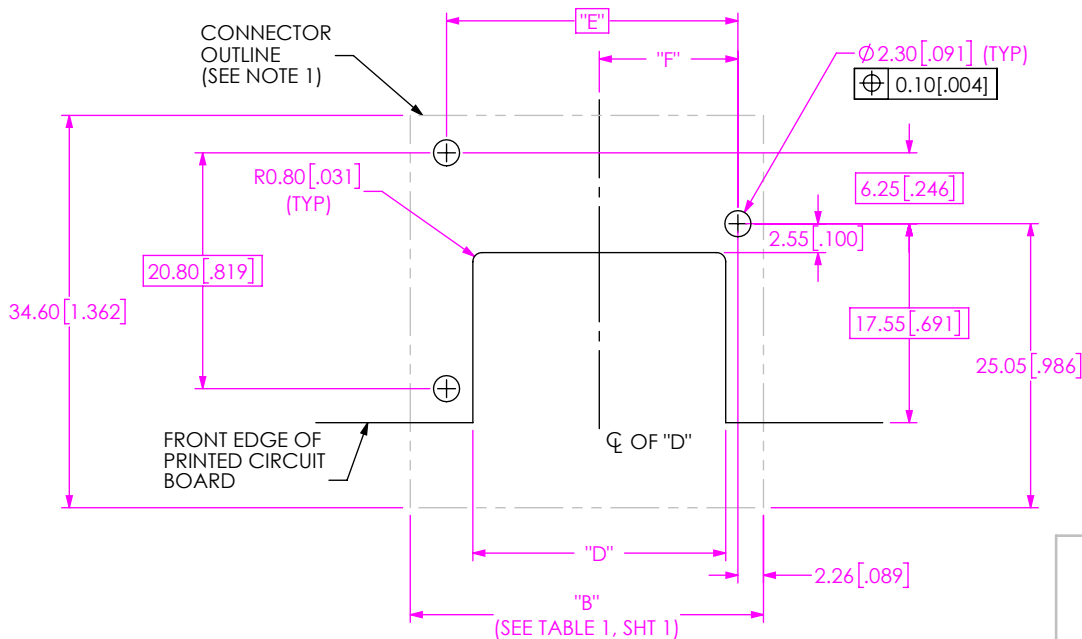



FIG 7
PCB CUTOUT FOR END 2, LEFT GUIDANCE
EBCF-X-4-10-V-X-XX-R-X-L-X SHOWN
(DIFFERENT AS SHOWN, OTHERWISE SAME AS FIG 6)

PCB NOTES:
1. CONNECTOR ENVELOPE DIMENSIONS. OTHER COMPONENTS
PLACED ON PCB SHALL AVOID THIS ZONE.

<p>PROPRIETARY NOTE</p> <p>THIS DOCUMENT CONTAINS CONFIDENTIAL AND PROPRIETARY INFORMATION AND ALL DESIGN, MANUFACTURING, REPRODUCTION, USE, PATENT RIGHTS AND SALES RIGHTS ARE EXPRESSLY RESERVED BY SAMTEC, INC. THIS DOCUMENT SHALL NOT BE DISCLOSED, IN WHOLE OR PART, TO ANY UNAUTHORIZED PERSON OR ENTITY NOR REPRODUCED, TRANSFERRED OR INCORPORATED IN ANY OTHER PROJECT IN ANY MANNER WITHOUT THE EXPRESS WRITTEN CONSENT OF SAMTEC, INC.</p>	 <p>520 PARK EAST BLVD, NEW ALBANY, IN 47150 PHONE: 812-944-6733 FAX: 812-948-5047 e-Mail info@SAMTEC.com code 55322</p>	
	<p>DO NOT SCALE DRAWING SHEET SCALE: 1:1</p>	<p>DESCRIPTION: EXAMAX BACKPLANE CABLE</p> <p>DWG. NO. EBCF-X-4-XX-V-X-XX-X-X-X-X</p> <p>BY: CANDY W 06/16/2017 SHEET 6 OF 6</p>