

ENERGIZER CR2016

Lithium Coin



Industry Standard Dimensions

mm (inches)

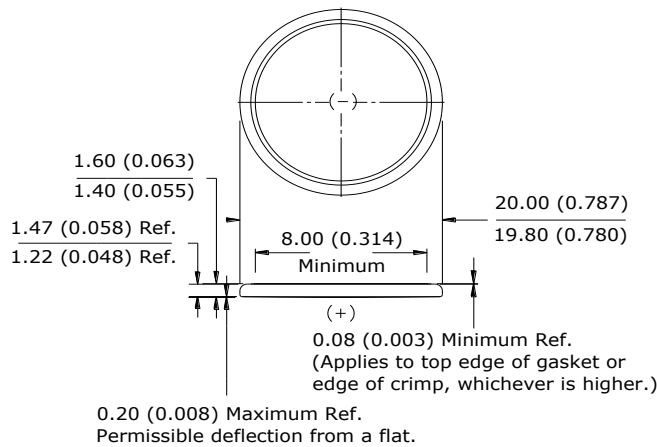

Simulated Application test

Typical Performance at 21°C (70°F)

Schedule:	Typical Drains: at 2.9V (mA)	Load (ohms)	Cutoff 2.0V (hours)
Continuous	0.1	30,000	1040

Typical Discharge Characteristics

Load: 30K ohms - Continuous
Typical Drain @ 2.9V: 0.097 mA

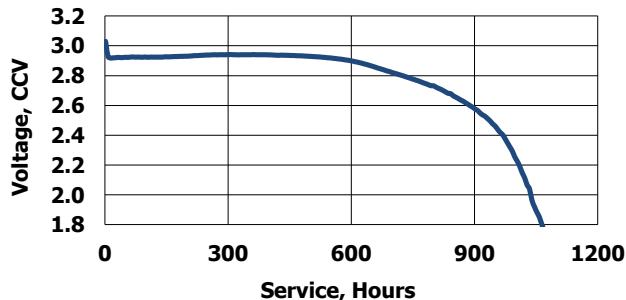

Internal Resistance Characteristics

Pulse Test at 21°C (70°F)

Bkgnd Drain: Continuous
30K ohms
0.1 mA @2.9V

Pulse Drain: 2 seconds X 12 times/day
400 ohms
6.8 mA @2.7V

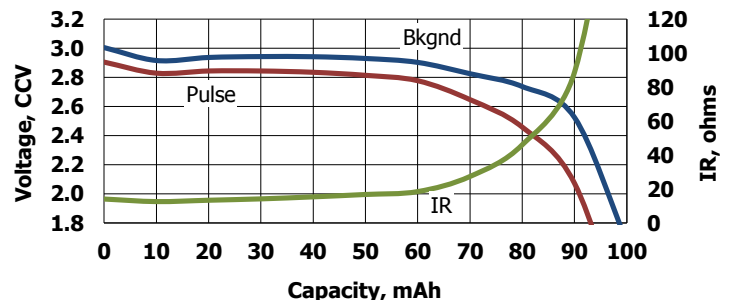

Important Notice

This datasheet contains typical information specific to products manufactured at the time of its publication.
Contents herein do not constitute a warranty and are for reference only.

Specifications

Classification:	"Lithium Coin"
Chemical System:	Lithium / Manganese Dioxide (Li/MnO ₂)
Designation:	ANSI / NEDA-5000LC, IEC-CR2016
Nominal Voltage:	3.0 Volts
Typical Capacity:	100 mAh (to 2.0 volts) (Rated at 30K ohms at 21°C)
Typical Weight:	1.9 grams (0.07 oz.)
Typical Volume:	0.5 cubic centimeters (0.03 cubic inch)
Max Rev Charge:	1 microampere
Energy Density:	122 milliwatt hr/g, 464 milliwatt hr/cc
Typical Li Content:	0.036 grams (0.0013 oz.)
Operating Temp:	-30C to 60C
Self Discharge:	~1% / year

Safety:



(1) KEEP OUT OF REACH OF CHILDREN. Swallowing may lead to serious injury or death in as little as 2 hours due to chemical burns and potential perforation of the esophagus. **Immediately see doctor; have doctor phone (800) 498-8666.**

(2) Battery compartment design. To prevent children from removing batteries, battery compartments should be designed with one of the following methods: a) a tool such as screwdriver or coin is required to open battery compartment or b) the battery compartment door/cover requires the application of a minimum of two independent and simultaneous movements of the securing mechanism to open by hand. Screws should remain captive with the battery door or cover.