

Digitized Automation for a Changing World

# Delta Industrial PC-Based Motion Control Solution Motion Control Card Series



[www.deltaww.com](http://www.deltaww.com)

 **DELTA**  
Smarter. Greener. Together.

## High-Speed Communication Solution for Multi-Axis and Synchronous Motion Control

The Delta Industrial PC-Based Motion Control Solution features a one-wire protocol for unimpeded access, achieving easy wiring, high synchronization, and excellent motion control performance. With Delta's flexible dynamic-link library (DLL), it easily connects Delta's motion control cards to multiple control devices such as servo motors, linear motors, remote digital I/O modules, analog modules, and pulse I/O modules for real-time data exchanges and high-precision technical programming via the PCI/PCIe interface.

The solution is the best integrated motion control platform that effortlessly fulfills the need for multi-axis and synchronous motion control with enhanced stability, flexible extension capabilities and versatile operation for industry upgrades.

### Four Major Features

- ▶ Supports EtherCAT and DMCNET communication motion control cards
- ▶ Connects to a variety of peripheral devices with standard Ethernet structure, such as servo motors, remote digital I/O and analog modules and stepping motors. direct drive DD motors and linear motors.
- ▶ Offers a high-security IC device for each motion control card for confidential programming protection
- ▶ Fieldbus verification and validation software provides easy configuration with relevant parameters of the fieldbus communication segment and hardware system, reducing programming cost and third-party software



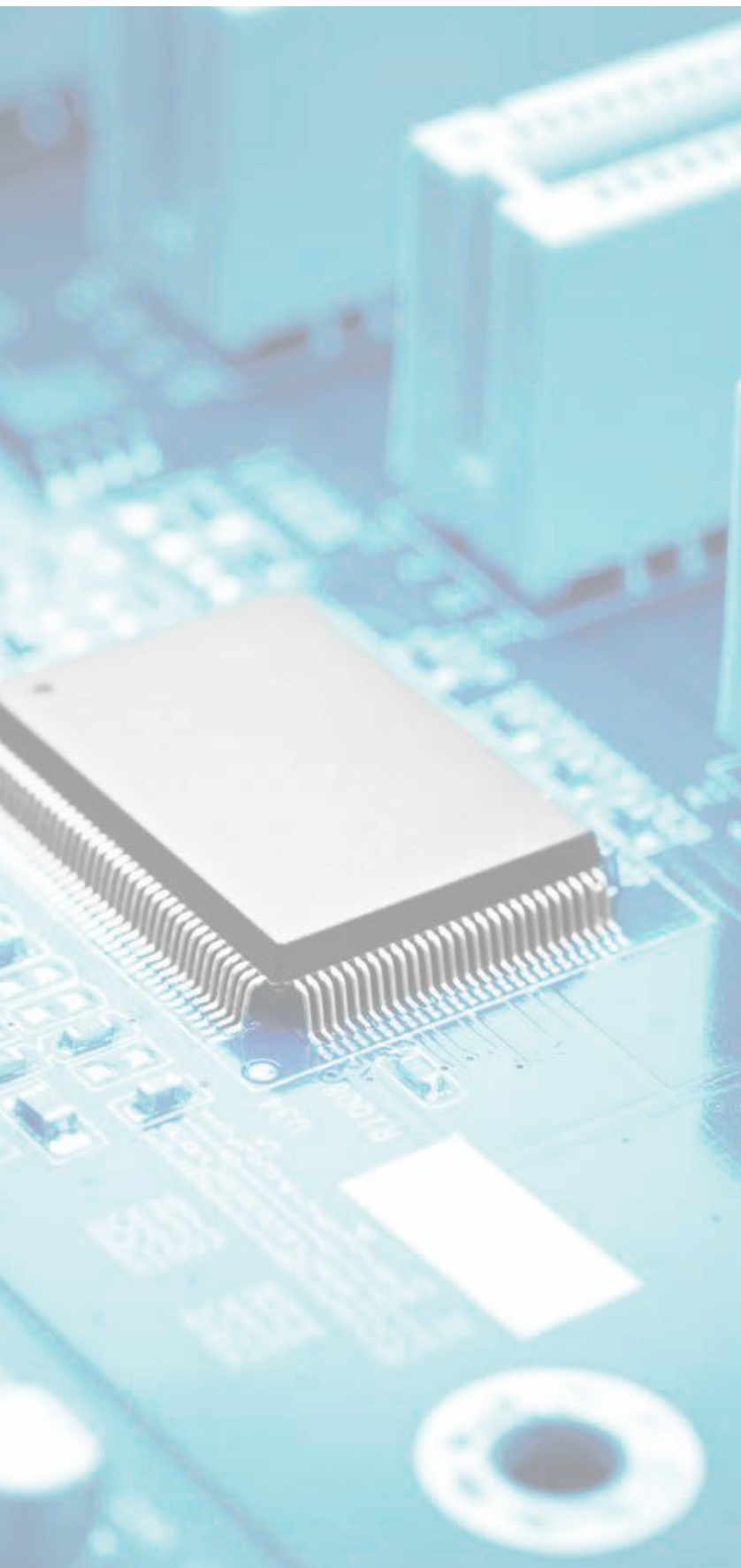

## Table of Contents

---

Introduction to Delta Industrial PC-Based Motion Control Solution	1
EtherCAT System Configuration and Product Features	3
Fieldbus Verification and Validation - EcNavi Software	5
DMCNET System Configuration and Product Features	7
Fieldbus Verification and Validation - EzDMC Software	15
Specifications of EtherCAT Motion Control Cards	17
EtherCAT Remote Modules	23
Specifications of DMCNET Motion Control Cards	31
DMCNET Remote Modules	45
Ordering Information	51

# EtherCAT System Structure

## Motion Controllers

EtherCAT Motion Control Card

Refer to p.17~22 for details.



PCI-E-L221-BxxD0 Series



PCI-L221-P1D0



PCI-L221-FxD0 Series



PCI-L221-BxxD0 Series

## Servo Systems

AC Servo Drive

ASDA-A3-E



ASDA-A2-E



ASDA-B3-E



\*\* Please refer to the catalogues of Delta's servo drives and motors ASDA Series for detailed specifications

### Gateway Type Remote Modules

Gateway Type E-Bus Remote Power Coupler



R1-EC5500D0

Refer to p.23 for details.

### Pulse Remote Module



1-Channel Pulse Remote Module

R1-EC5621D0

Refer to p.24 for details.

### Digital Remote Modules

16 Digital Input Remote Module

R1-EC6002D0  
R1-EC6022D0



16 Digital Input Remote Module

R1-EC7062D0  
R1-EC70A2D0  
R1-EC70E2D0  
R1-EC70F2D0

Remote Module R2-EC0902D0



Refer to p.25~27 for details.

### Analog Remote Modules

4-Channel Analog Input Remote Module

R1-EC8124D0



4-Channel Analog Output Remote Module

R1-EC9144D0

Refer to p.28~29 for details.

### Functional Remote Modules

For Manual Pulse Generator (MPG)

R1-EC5614D0



Refer to p.30 for details.



# High-Speed Motion Control System - EtherCAT Product Features

Ethernet Central Automation Technology (EtherCAT) is an open Ethernet-based fieldbus system that provides high-efficiency and high-performance synchronization quality for automation control. With EtherCAT, Delta's EtherCAT motion control cards achieve rapid and real-time multiple axes of motion control, and are capable of controlling up to 64 slave stations that enable a 32-axis motion control within 1ms cycle time. The cards also provide 35 homing modes, point-to-point position control, 2-axis interpolation, 3-axis interpolation, multi-axis synchronization, continuous motion, gantry control, speed control, torque control and more.

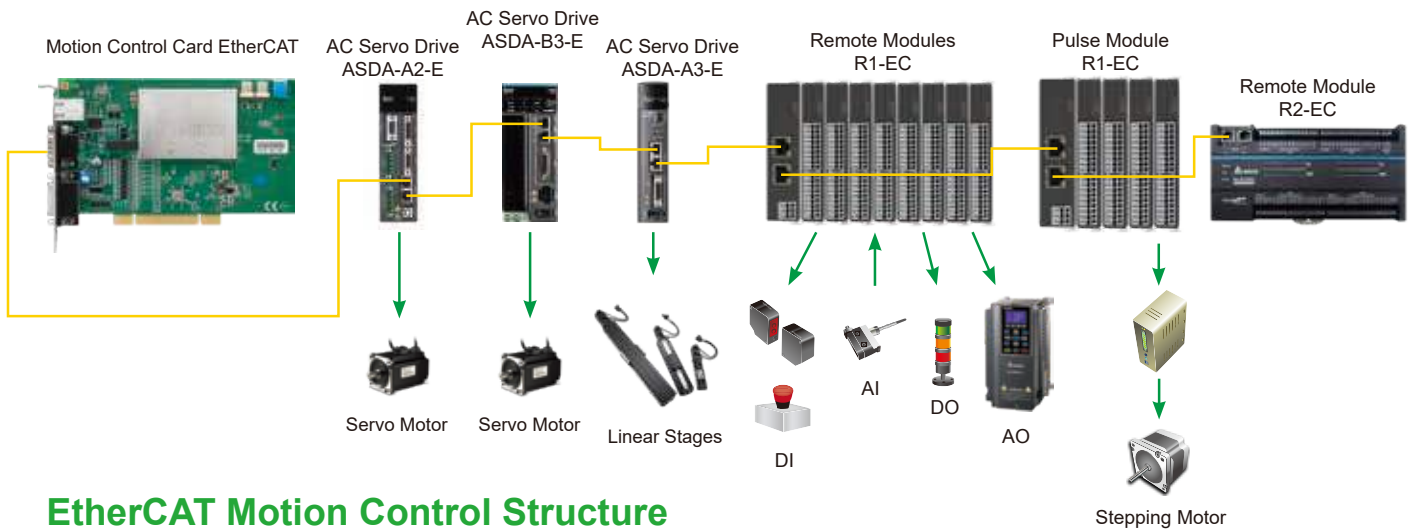

## EtherCAT Motion Control Structure

Delta provides high-speed motion control cards with complete functions for EtherCAT masters. Supporting device descriptions in XML format (EtherCAT Slave Information - ESI), the motion control cards also allow the system to quickly identify ESI files and offer the capability of real-time connection via EtherCAT for high level integration. The cards can adjust the communication cycle time between stations within 1 ms~0.5ms according to customer needs.

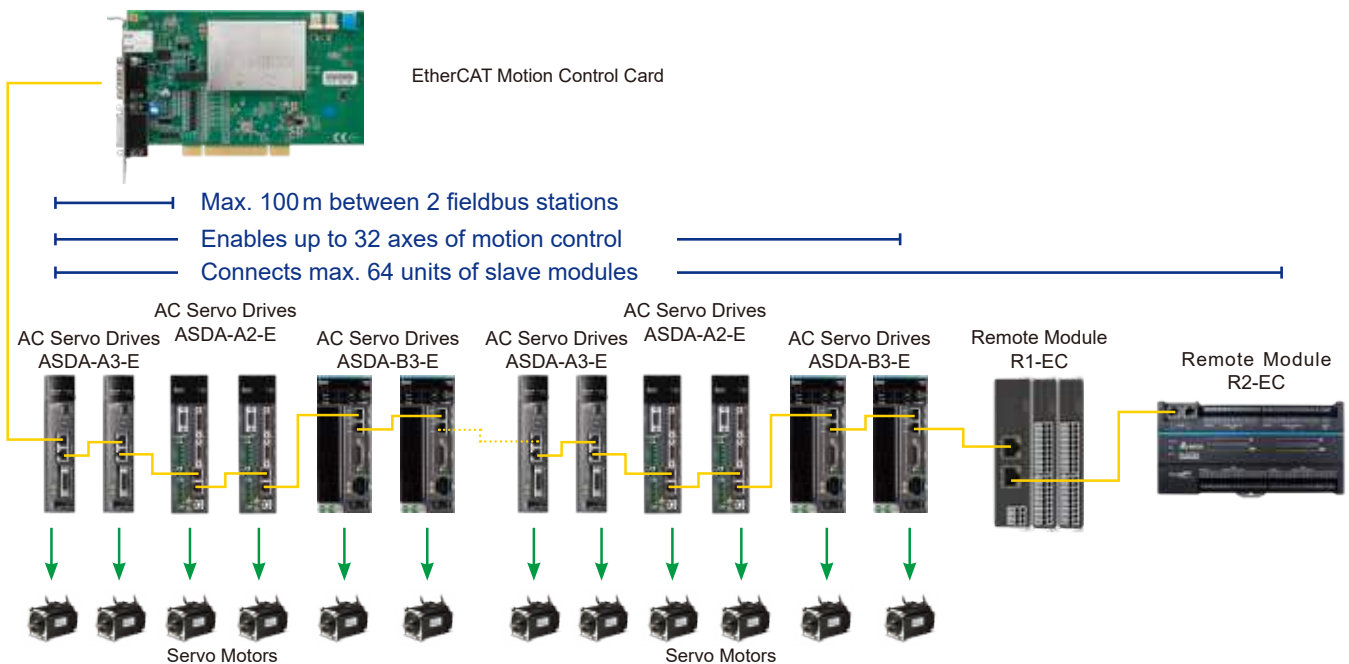

# Fieldbus Verification and Validation - EcNavi Software

EcNavi development software is for configuring an EtherCAT network that includes an EtherCAT master controller and slave devices for data communication, functional identification, programming and debugging. For new users of Delta's EtherCAT motion control, the EcNavi helps them become familiar with the configuration of the system and to complete the function verification and validation in real time.

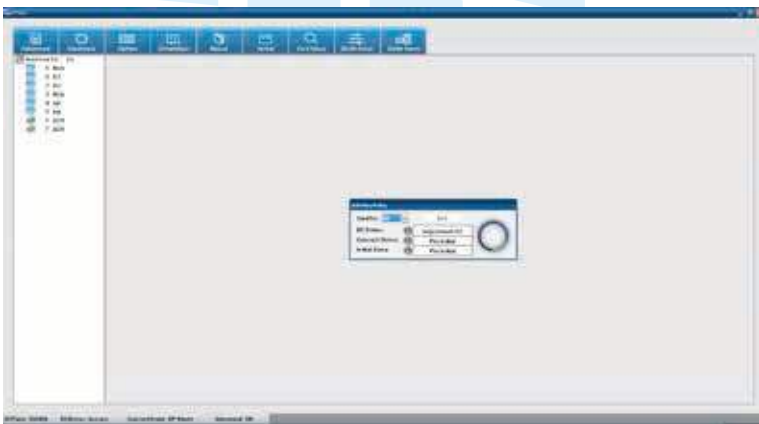

## ► Hardware Structure Search

Provides a search function for all slaves connected by EtherCAT to check hardware configuration and verify whether network communication is established successfully via software

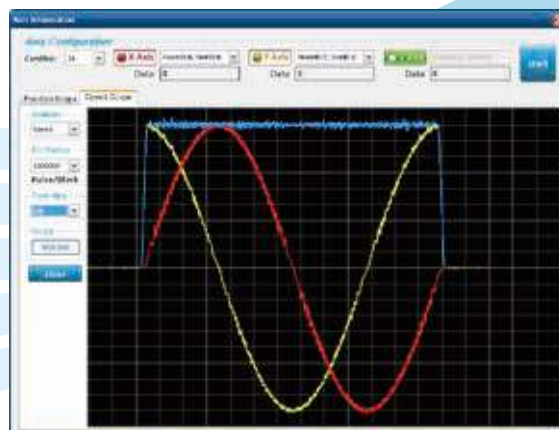

## ► Speed Curve Tracing

Offers real-time tracing for speed curves of current motion commands to achieve better synchronization effects between multiple axes

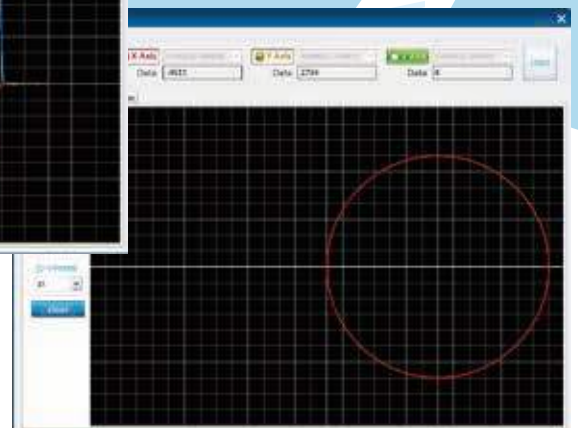





► **Independent Control Unit**





Helps users avoid writing complex programs and immediately verifies all motion commands with the servo drives to meet application requirements



► **Multi-Axis Motion Control Mode**

Offers a variety of sample programs and control modes for EtherCAT devices (e.g. Linear 2, Linear 3, Heli, Circle, Circle 2 and Circle 3) to help users easily edit and complete development programs for multi-axis motion control applications

# DMCNET System Structure

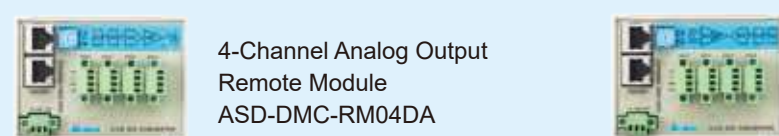
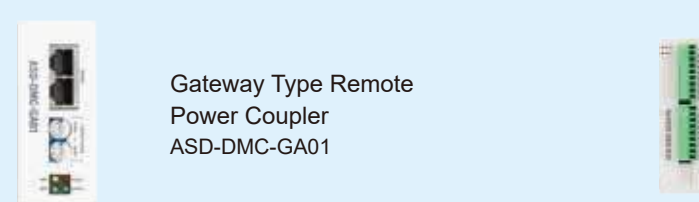
Motion Controllers	<p>Motion Control Cards</p>  <p>PCI-DMC-A02    PCI-DMC-B01    PCI-DMC-B02    PCI-DMC-B03    PCI-DMC-F02</p> <p style="text-align: right;">Refer to p.31~50 for details.</p>
	<p>Servo Systems</p> <p>Servo Motors and Drives</p>  <p>ASDA-A3-F    ASDA-A2-F    ASDA-B3-F    ASDA-B2-F    ASDA-M</p> <p>** Please refer to the catalogues of Delta's servo drives and motors ASDA Series for detailed specifications</p>
Digital Remote Modules	 <p>32 Digital Input Remote Module ASD-DMC-RM32MN    64 Digital Input Remote Module ASD-DMC-RM64MN    Digital I/O Remote Module HMC-RIO3232RT5</p>
	 <p>32 Digital Output Remote Module ASD-DMC-RM32NT    64 Digital Output Remote Module ASD-DMC-RM64NT    32 Digital I/O Remote Module ASD-DMC-RM32PT</p> <p style="text-align: right;">Refer to p.45~47 for details.</p>
<p>Pulse Remote Module</p>	 <p>4-Channel Pulse Remote Module ASD-DMC-RM04PI</p> <p style="text-align: right;">Refer to p.48 for details.</p>
<p>Analog Remote Modules</p>	 <p>4-Channel Analog Output Remote Module ASD-DMC-RM04DA    4-Channel Analog Input Remote Module ASD-DMC-RM04AD</p> <p style="text-align: right;">Refer to p.49 for details.</p>
<p>Gateway Type Remote Modules</p>	 <p>Gateway Type Remote Power Coupler ASD-DMC-GA01    Gateway Type 1-Channel Pulse Remote Module ASD-DMC-GE01PH</p> <p style="text-align: right;">Refer to p.50 for details.</p>



# Delta's High-Speed Motion Control System - DMCNET Product Features

Delta's Motion Control NETwork (DMCNET) is a high speed, real-time communication system, capable of controlling up to 12 axes of servo system units within 1ms simultaneously: with 3-axis helical and linear interpolation in 4 groups, or 2-axis linear and arc interpolation in 6 groups. It supports 64-bit dual precision floating point, allowing high-precision system calculations and flexible operation, and also absolute commands, incremental commands and T-curve / S-curve velocity profiles for different uses. With built-in position, speed and torque control modes, and 35 homing modes, it is able to receive real-time servo information, parameters, or change control modes via communication command, offering fast communication and motion control for various applications.

## DMCNET Motion Control Structure

DMCNET is equipped with the high-speed and reliable one-wire DMCNET communication protocol for diverse motion control applications. Adapted depending on customer's needs, Delta's PCI motion control cards are available in three series: the 12-axis PCI-DMC-A02, 6-axis PCI-DMC-F02 with digital I/O interfaces and the PCI-DMC-B01 with pulse compare & capture functions. All series are able to connect to multiple servo systems, such as the high performance ASDA-A3-F & ASDA-A2-F Series and the standard ASDA-B3-F & ASDA-B2-F Series. It establishes a total motion control solution enabling lower system cost and superior performance to increase end-product value and competitiveness.

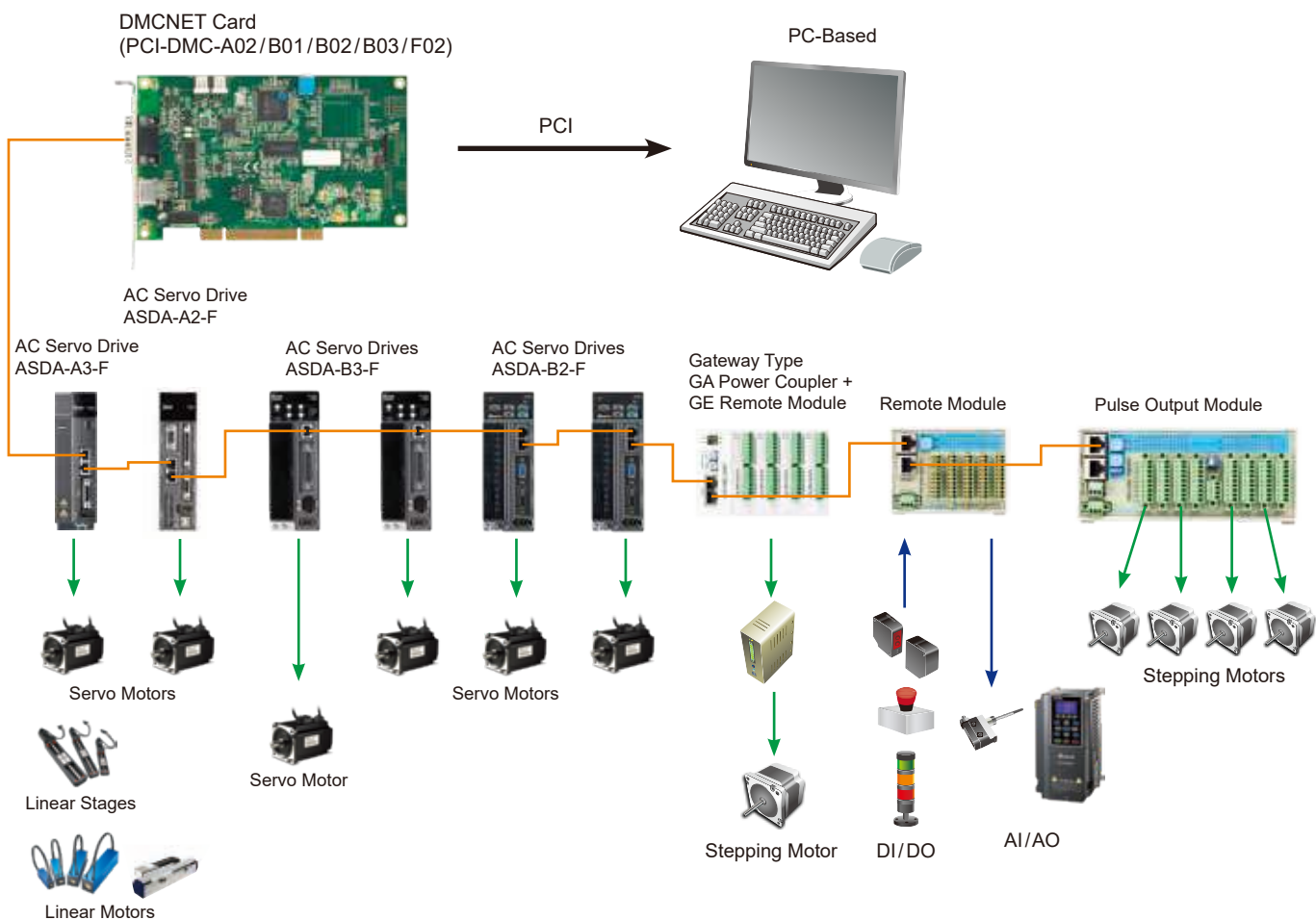

## DMCNET Communication

The DMCNET is a motion control communication network that is able to control up to 12 servo drives or modules in serial connection on the same fieldbus, simplifying wiring as well as saving cost. With its fast and stable communication speed that deals with commands of the servo motors and modules within 1ms simultaneously, DMCNET offers an easy, fast and stable communication system solution that makes motion control easier.

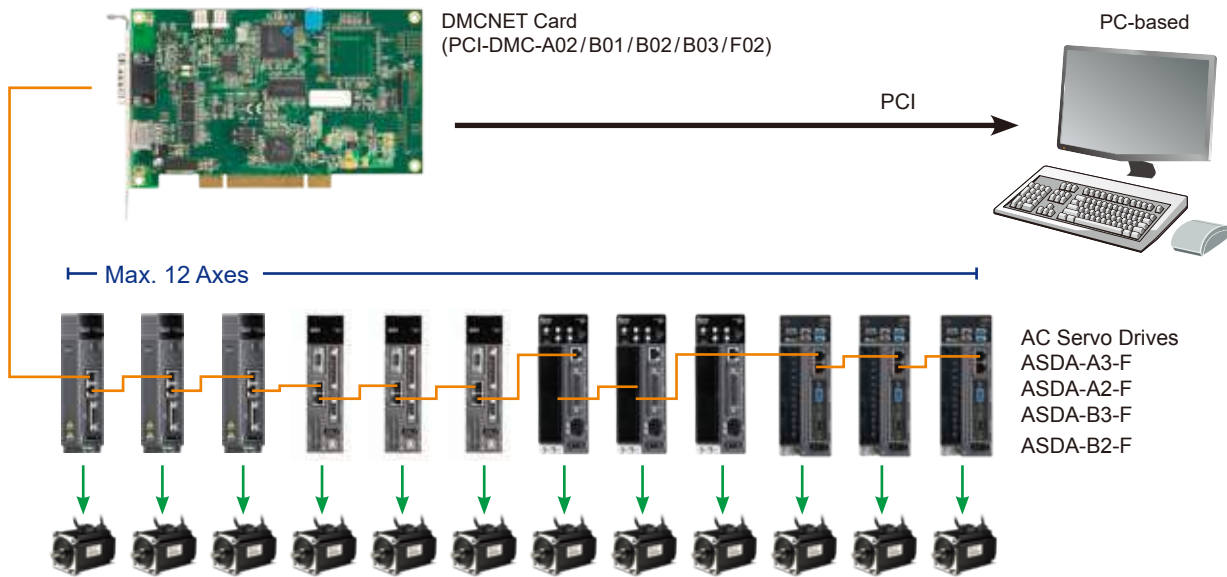

## DMCNET I/O Control Structure

In a pure I/O control structure, DMCNET is capable of controlling up to 12 remote module units, which include a total of 768 digital inputs and outputs, offering customers a more flexible and effective solution.

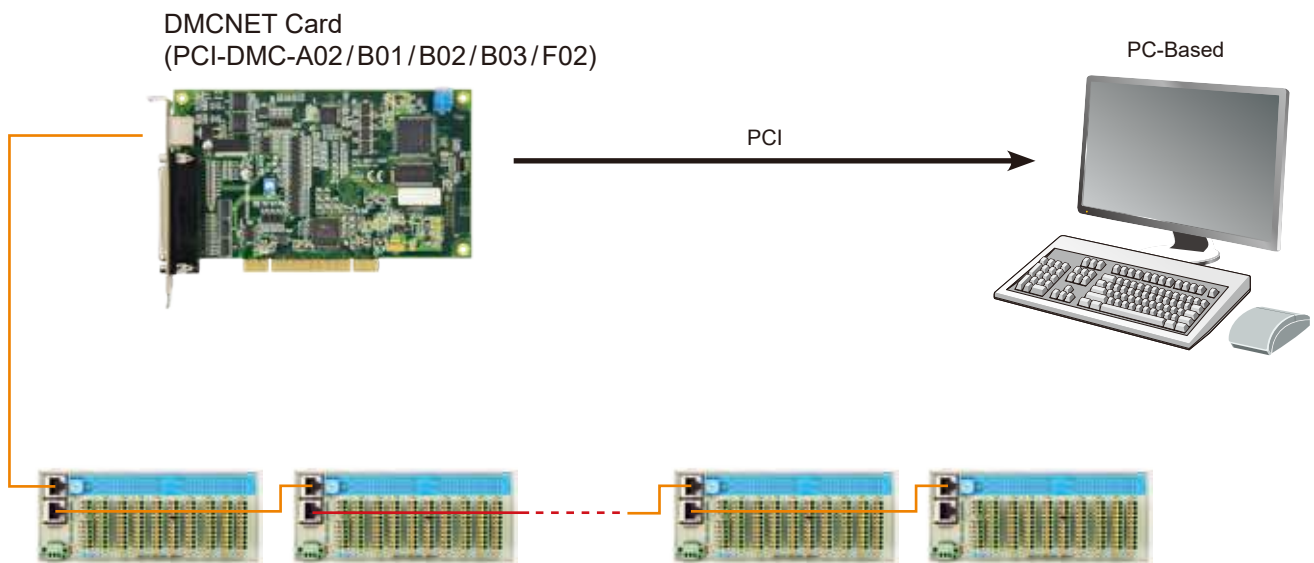



# Motion Control Functions

## Multi-Group Synchronous Control

The DMCNET is capable of controlling 12 servo system units or 4 groups, 3-axis interpolation algorithms synchronously, realizing simultaneous 3-axis linear interpolation, 2-axis arc interpolation, 3-axis helical interpolation and continuous interpolation. It can also transfer the data of 12 servo motor units, or 768 digital inputs and outputs within 1 ms simultaneously.

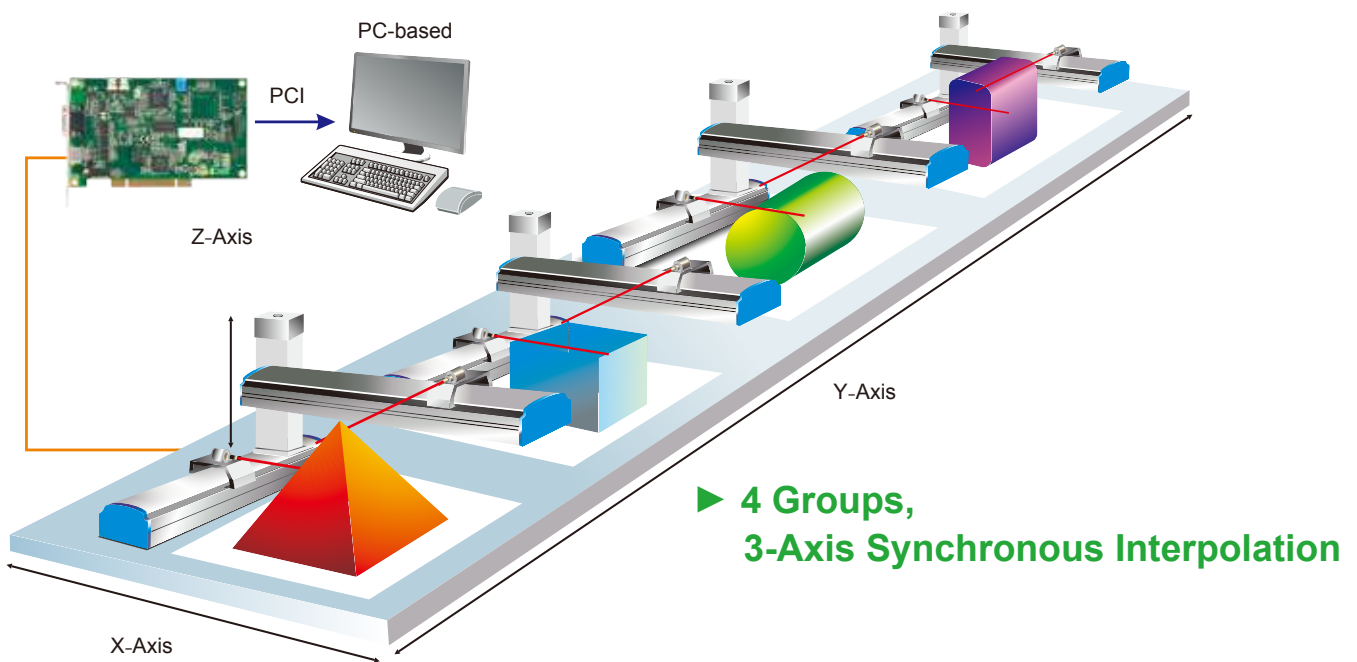

### ► 3-Axis Interpolation

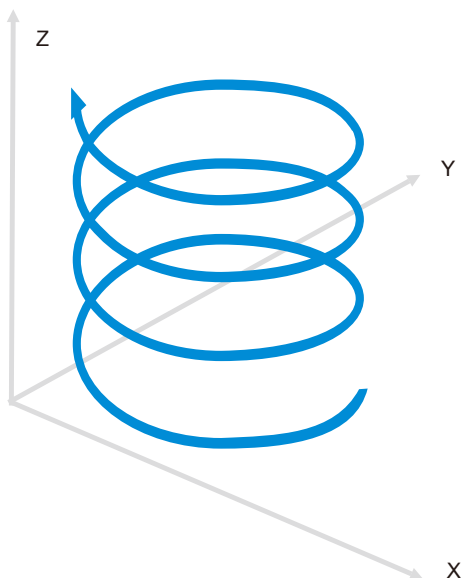

### ► 2-Axis Interpolation

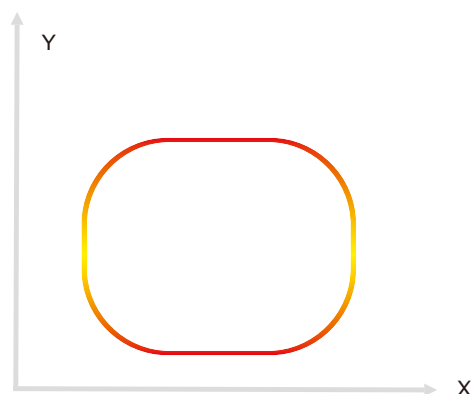

# Standard / Economical Motion Control Card PCI-DMC-A02 / PCI-DMC-F02

## Rapid Configuration and Easy Control with Digital I/O Interfaces

The PCI-DMC-A02 and PCI-DMC-F02 motion control cards are built-in with digital local I/O interfaces that are equipped with up to 32 digital inputs and 24 digital outputs. Without controlling through communication, the motion cards are able to rapidly capture and identify I/O messages, enhancing the controlling efficiency of the system. For users who have fewer I/O needs, this helps save cost with extended axes and rapid response (the PCI-DMC-F02 motion control card controls up to 6 axes). In addition, the motion cards can connect to a manual pulse generator (MPG) and conduct system adjustment directly, achieving real-time configuration and flexible operation.

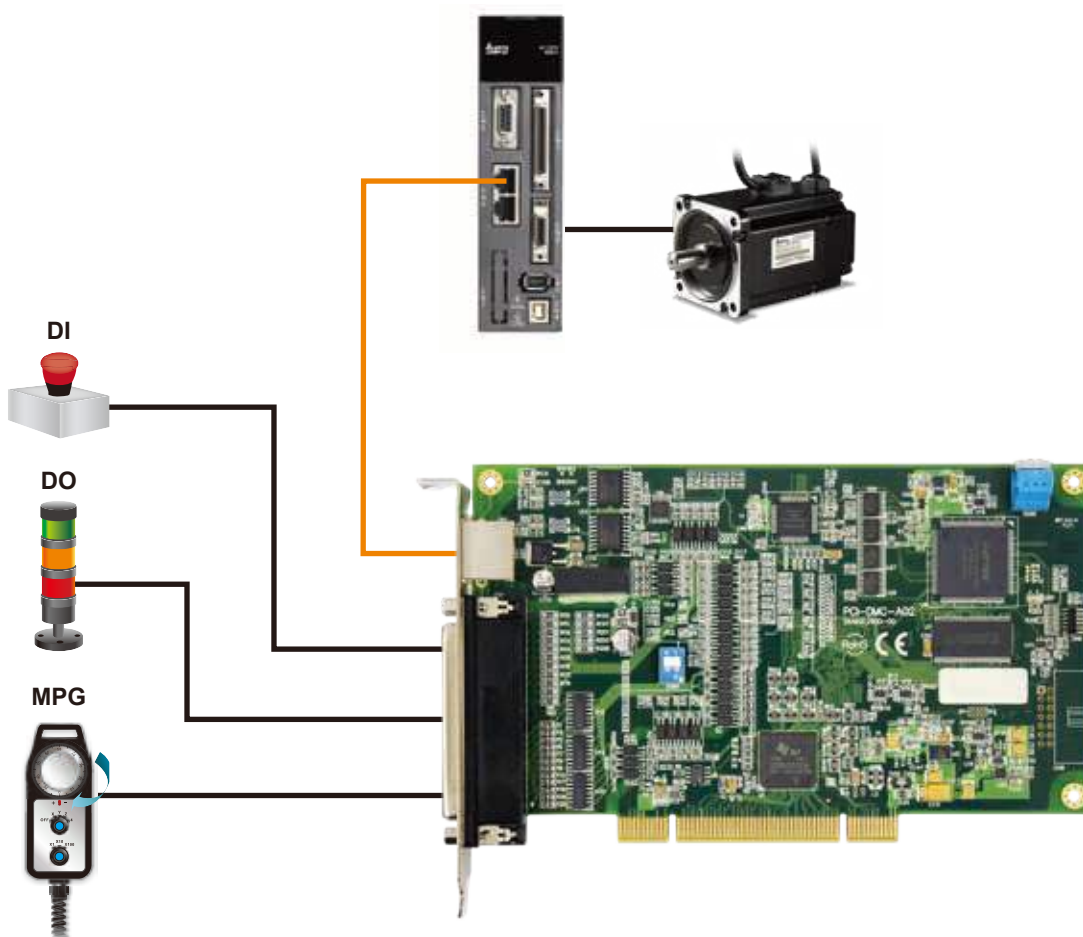

# Advanced Motion Control Card PCI-DMC-B01

## Real-time Capture and Compare Functions

The capture function inputs a retrieve pulse to the control cards via an encoder and performs a pulse compare to remotely trigger the camera shutter and take pictures in equally spaced or unequally spaced pulse positions at a set time interval.

The PCI-DMC-B01 motion card provides 2 groups of real time pulse capture and 2 groups of compare functions.

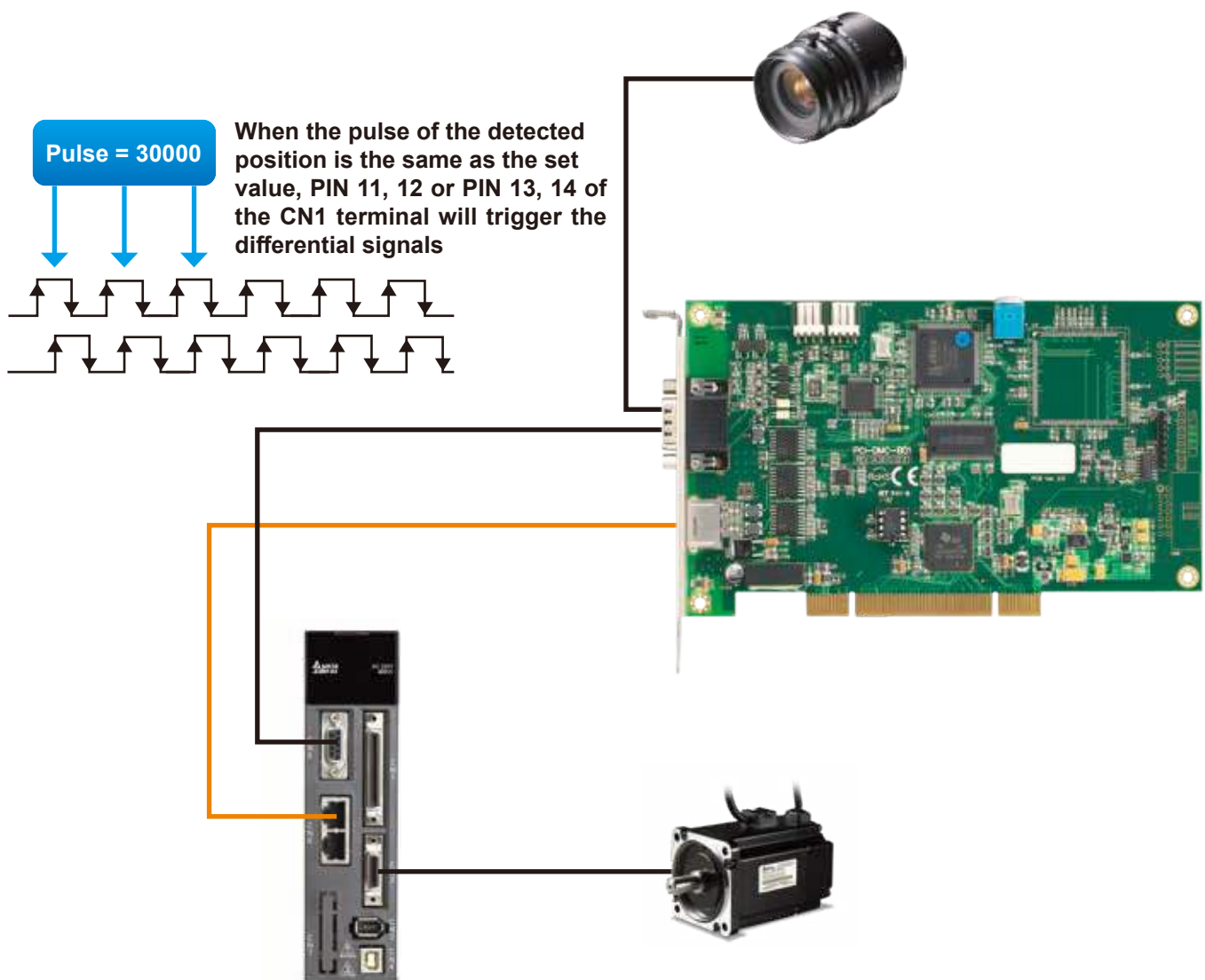



# Advanced Motion Control Card PCI-DMC-B02

## Real-time Capture and 2D Compare Functions

- The X and Y-axis path planning function can set the position and inputs the retrieve pulses of X and Y-axis to the control cards via an encoder. Users set 2D compare condition and speed to remotely trigger the camera shutter and take pictures.
- The PCI-DMC-B02 motion card provides 3 groups of real time pulse capture and 10 groups of compare functions.

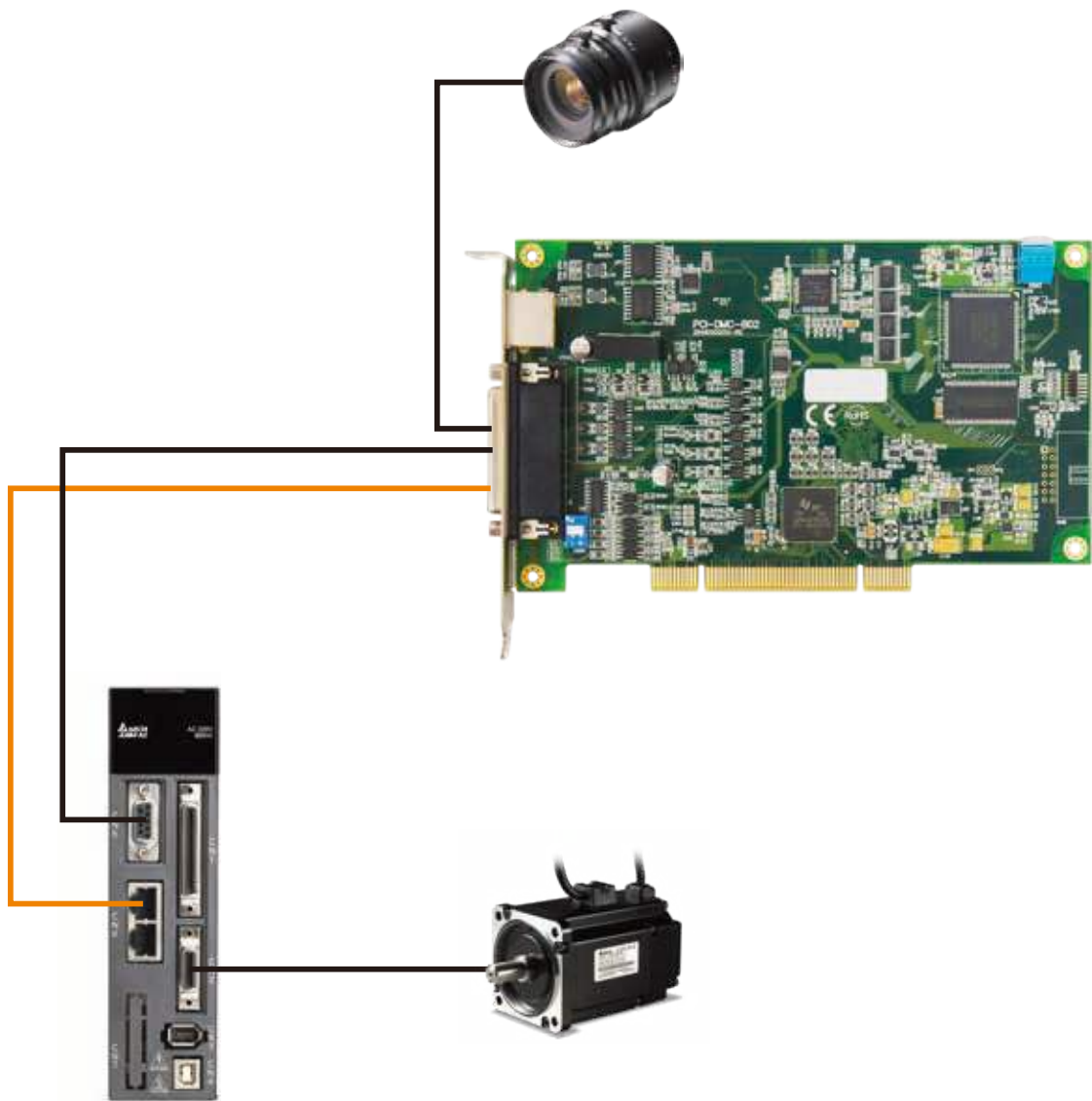

# Advanced Motion Control Card PCI-DMC-B03

## Real-time Capture and Multiple Compare Functions

- The capture function inputs a retrieve pulse to the control cards via an encoder and performs a pulse compare to remotely trigger the camera shutter and take pictures in equally spaced or unequally spaced pulse positions at a set time interval.
- The PCI-DMC-B03 motion card provides 3 groups of real time pulse capture, 4 groups of equally spaced compare pulse triggers, and 6 groups of unequally spaced compare pulse triggers.

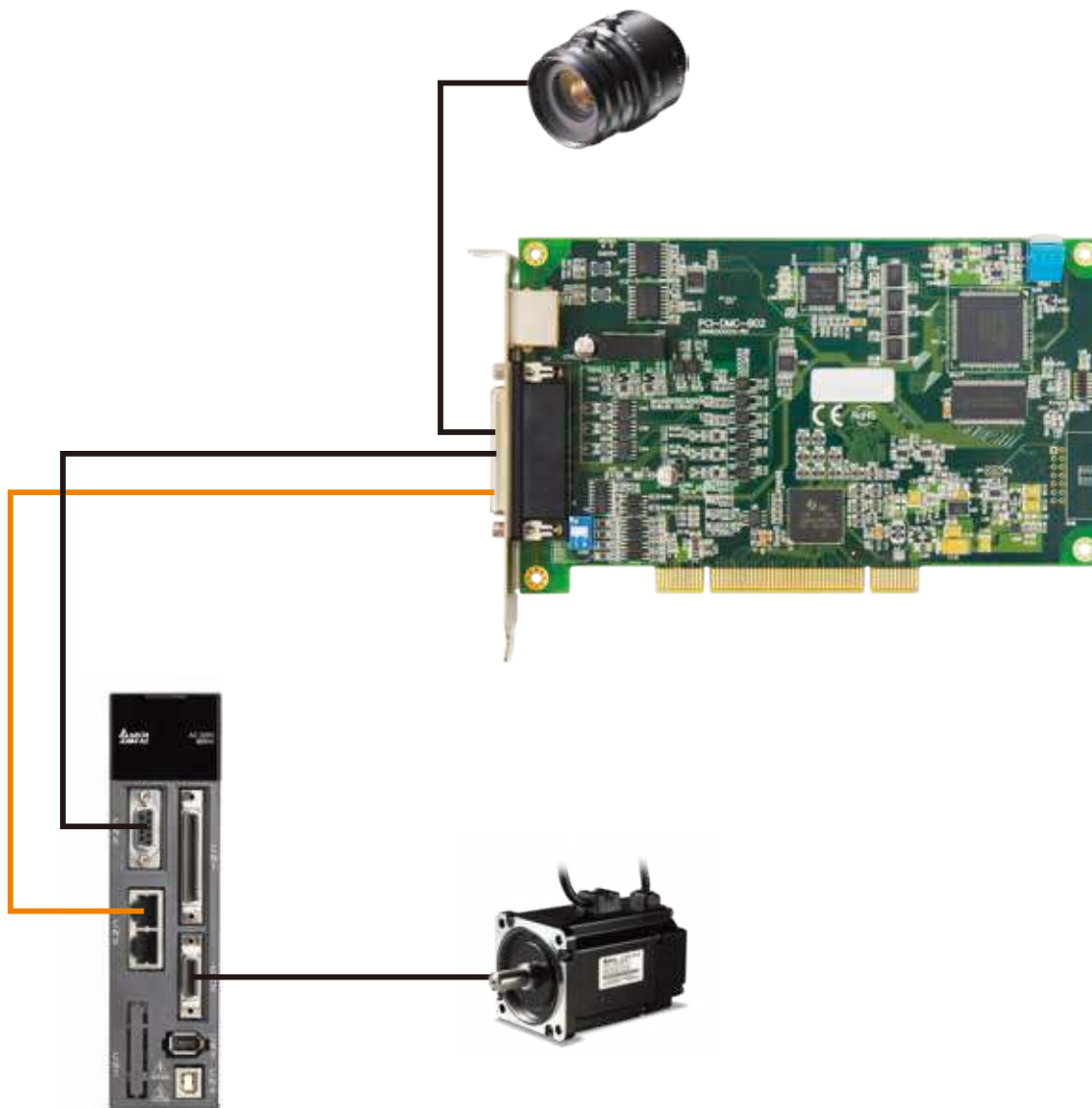

# Fieldbus Verification and Validation - EzDMC Software

EzDMC Software provides simple editing functions for all the relevant parameters of the fieldbus communication and facilitates easy configuration of program development and the hardware system. Even first time users of Delta's DMCNET motion control cards can utilize the motion control card functions.

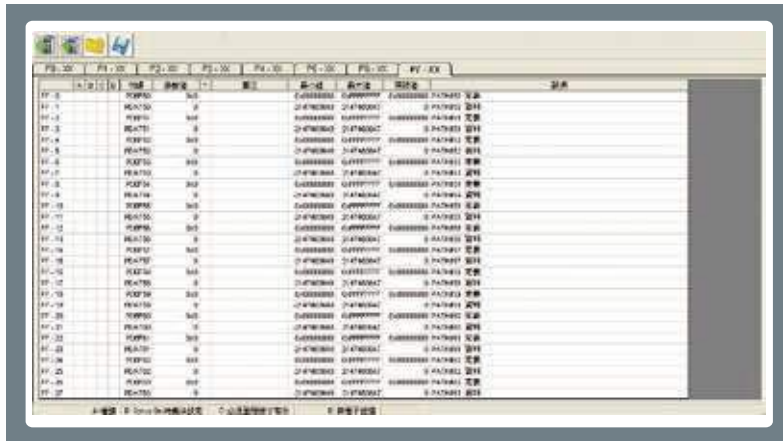

## ► User-Friendly Operator Interface

Helps users create and edit programs with clear images, easy-to-use parameter settings

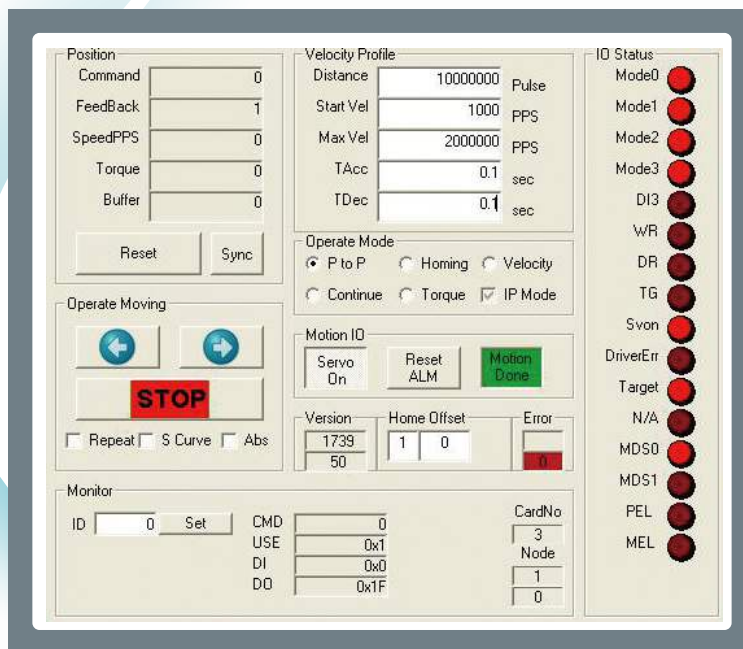

## ► Independent Control Unit

With the independent control unit, users can set up simple motions of the servo drives for flexible operation and management





### ► Multi-Axis Motion Control Modes

Offers a variety of sample programs and control modes (e.g. Linear 2, Linear 3, Heli, Circle, Circle 2 and Circle 3) for linear, arc and helical interpolation to supervise various multi-axis motions and execute programming for multi-axis motion control applications

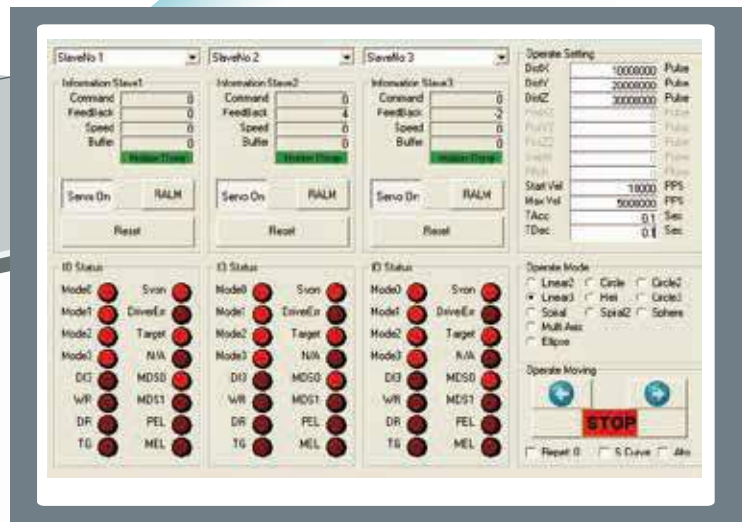
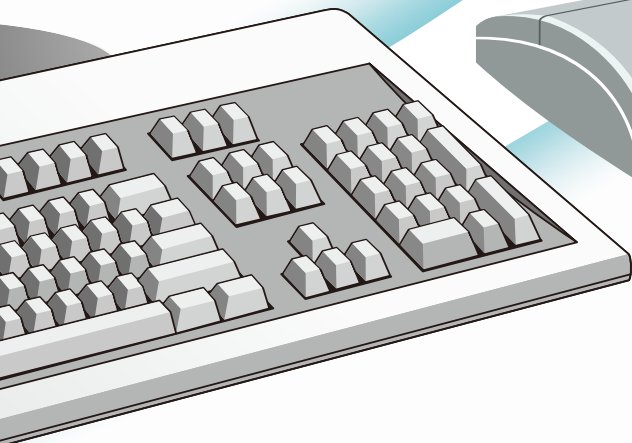

### ► Real-time Response and Feedback

Monitoring and displaying the status of the connected servo drives is completed in a timely and efficient manner

# EtherCAT Motion Control Card

- Standard Type PCIE-L221-Bxx Series

## Specifications

Model Name	PCIE-L221-B1D0/PCIE-L221-BF1D0/PCIE-L221-BF0D0
Ring	1 Ring
Communication Interface	RJ45
Communication Cable	CAT-5e
Communication Speed	100Mbps
Communication Distance	Max. 100 m
Communication Hose and Slave Module	Max. 64
Motion Control Capability	Synchronous Control of up to 32/16/8 axes
Digital Input	13-CH isolated, SINK/SOURCE type, 24 V <sub>DC</sub> (5mA/CH)
Digital Output	13-CH isolated, SINK, 24 V <sub>DC</sub> (100 mA/CH)
Encoder Output	2-CH isolated, EA±/EB±
Compare Output	2-CH isolated · CMP± Interval: 100 K · Table: 40K
Technical Indicators	PCI Spec. 2.2; supports 32-bit, 3.3/5V <sub>DC</sub> operation
Power Consumption	+5V <sub>DC</sub> at 1A typical
Operation Temperature	0°C ~ 50°C
Safety Certification	CE 

## Exterior of the Motion Control Card

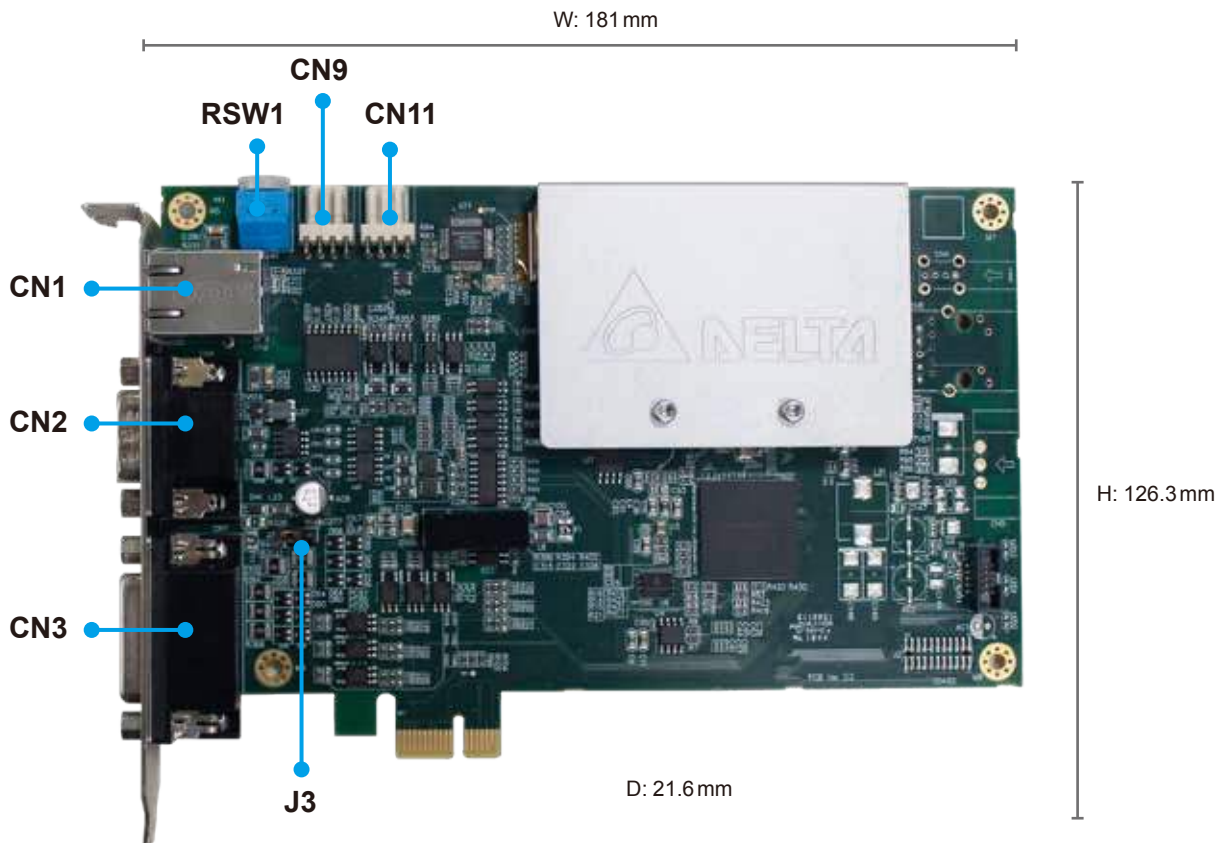

Note: This is a photo of PCIE-L221-B1D0. The PCB color of PCIE-L221-BF1D0 and PCIE-L221-BF0D0 cards is blue.

Title	Function	Title	Function
CN1	EtherCAT Expansion Module Connector	CN11	3.3V Compare Output (Channel 2 MOS)
CN2	Encoder & Compare Connector	RSW1	Card ID Number Setting Dial
CN3	Output/Input Signal Connector	J3	SINK/SOURCE Loop Switch
CN9	3.3V Compare Output (Channel 1 MOS)		

### ● CN1: EtherCAT Expansion Module Connector



PIN	Label	Description
1	TX+	Transmitted Data +
2	TX-	Transmitted Data -
3	RX+	Received Data +
6	RX-	Received Data -
LED (right)	GREEN	Link/Activity

### ● CN2: Encoder & Compare Connector

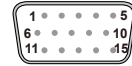

PIN	Label	Description	PIN	Label	Description
1	QA_1-	1st QA Signal (-)	9	QB_2+	2nd QB Signal (+)
2	QB_1-	1st QB Signal (-)	10	I/O IN	I/O Differential Signal
3	QA_2-	2nd QA Signal (-)	11	CMP_1+(RS-422)	1st RS422 Differential Signal (+) 5V
4	QB_2-	2nd QB Signal (-)	12	CMP_1- (RS-422)	1st RS422 Differential Signal (-) GND
5	External GND	GND Signal	13	CMP_2+(RS-422)	2nd RS422 Differential Signal (+) 5V
6	QA_1+	1st QA Signal (+)	14	CMP_2- (RS-422)	2nd RS422 Differential Signal (-) GND
7	QB_1+	1st QB Signal (+)	15	I/O OUT	I/O Output Signal
8	QA_2+	2nd QA Signal (+)			

### ● CN3: Digital Input/Output Connector

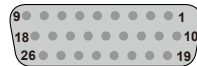

PIN	Label	Description	PIN	Label	Description
1	I/O IN 0	I/O Input Signal	14	I/O OUT 4	I/O Output Signal
2	I/O IN 1	I/O Input Signal	15	I/O OUT 5	I/O Output Signal
3	I/O IN 2	I/O Input Signal	16	I/O OUT 6	I/O Output Signal
4	I/O IN 3	I/O Input Signal	17	I/O OUT 7	I/O Output Signal
5	I/O IN 4	I/O Input Signal	18	External GND	GND Signal
6	I/O IN 5	I/O Input Signal	19	I/O IN 8	I/O Input Signal
7	I/O IN 6	I/O Input Signal	20	I/O IN 9	I/O Input Signal
8	I/O IN 7	I/O Input Signal	21	I/O IN 10	I/O Input Signal
9	External GND	GND Signal	22	I/O IN 11	I/O Input Signal
10	I/O OUT 0	I/O Output Signal	23	I/O OUT 8	I/O Output Signal
11	I/O OUT 1	I/O Output Signal	24	I/O OUT 9	I/O Output Signal
12	I/O OUT 2	I/O Output Signal	25	I/O OUT 10	I/O Output Signal
13	I/O OUT 3	I/O Output Signal	26	I/O OUT 11	I/O Output Signal

### ● CN9 : 3.3V Compare Output 1

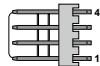

PIN	Label	Description
1	CMP_OUT1(QEP1)	CMOS 3.3V Position Compare Signal Output
2	GND	GND Signal
3	CMP_+(LVDS)	LVDS Differential Signal (+)
4	CMP_1- (LVDS)	LVDS Differential Signal (-)

### ● CN11 : 3.3V Compare Output 2

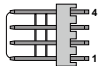

PIN	Label	Description
1	CMP_OUT2(QEP2)	CMOS 3.3V Position Compare Signal Output
2	GND	GND Signal
3	CMP_2+(LVDS)	LVDS Differential Signal (+)
4	CMP_2- (LVDS)	LVDS Differential Signal (-)

### ● J3 : SINK / SOURCE Loop Switch

Label	Description
1	I24V (Internal 24V Voltage Connector)
2	ICOM (Common Input Signal Connector)
3	24V Grounding Signal

### ● RSW1: Dial for Setting the Card ID Number



The number is set based on the value of the dial (between 0~15)

NPN mode: PIN1 & PIN2 short circuit (Default)  
PNP mode: PIN2 & PIN3 short circuit



# EtherCAT Motion Control Card

- Standard Type PCI-L221-P1D0/PCI-L221-F1D0/PCI-L221-F0D0

## Specifications

Model Name	PCI-L221-P1D0/PCI-L221-F1D0/PCI-L221-F0D0
Ring	1 Ring
Communication	RJ45
Communication Cable	CAT-5e
Communication Speed	100 Mbps
Communication Distance	Max. 100 m
Communication Host and Slave Module	Max. 64
Motion Control Capability	Synchronous Control of up to 32/16/8 axes
Digital Input	8-CH isolated, SINK/SOURCE type, 24 V <sub>DC</sub> (5 mA/CH)
Digital Output	4-CH isolated, SINK type, 24 V <sub>DC</sub> (100 mA/CH)
Technical Indicators	PCI Spec. 2.2; supports 32-bit, 3.3/5 V <sub>DC</sub> operation
Power Consumption	+5 V <sub>DC</sub> at 1A typical
Environment	0°C ~ 50°C
Safety Certification	CE 

## Exterior of the Motion Control Card

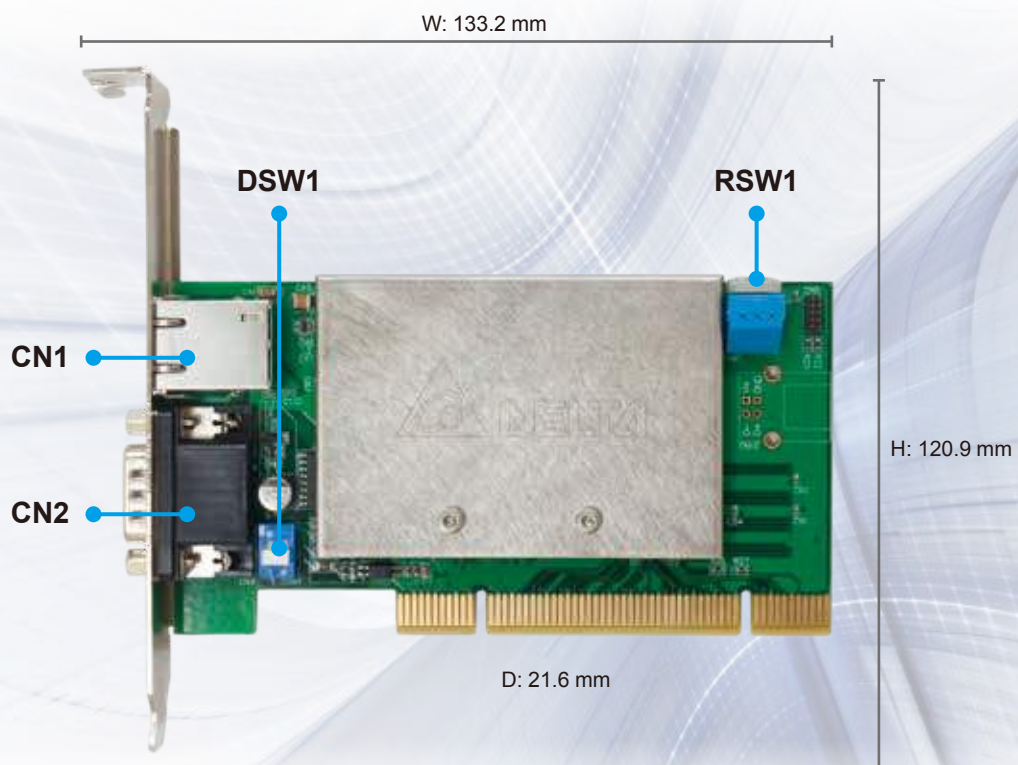

Note: This is a photo of PCI-L221-P1D0. The PCB color of PCI-L221-F1D0 and PCI-L221-F0D0 cards is blue.

- **CN1: EtherCAT Connection Port**

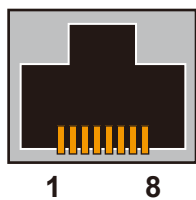

PIN	Label	Description
1	TX+	Transmission Signal (+)
2	TX-	Transmission Signal (-)
3	RX+	Transmission Signal (+)
6	RX-	Transmission Signal (-)

- **CN4: Digital Input/Output Connector**

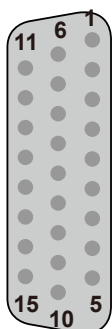

PIN	Label	Description	PIN	Label	Description
1	I/O IN 0	I/O Input Signal	9	I/O IN 6	I/O Input Signal
2	I/O IN 1	I/O Input Signal	10	I/O IN 7	I/O Input Signal
3	I/O IN 2	I/O Input Signal	11	External GND	GND Signal
4	I/O IN 3	I/O Input Signal	12	I/O OUT 0	I/O Output Signal
5	External GND	GND Signal	13	I/O OUT 1	I/O Output Signal
6	E24V	24 V <sub>DC</sub> Power	14	I/O OUT 2	I/O Output Signal
7	I/O IN 4	I/O Input Signal	15	I/O OUT 3	I/O Output Signal
8	IO IN 5	IO Input Signal			

- **DSW1: SINK/SOURCE Loop Switch**

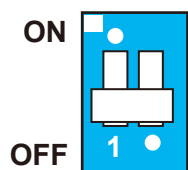

Label	Description
ON	SOURCE (Connects to PNP device)
OFF	SINK (Connects to NPN device)

- **RSW1: Dial for Setting the Card ID Number**

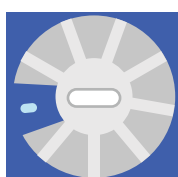

The number is set based on the value of the dial (between 0~15)

# EtherCAT Motion Control Card

- Advanced Type PCI-L221-BxxD0

## Specifications

Model Name	PCI-L221-B1D0/PCI-L221-BF1D0/PCI-L221-BF0D0
Ring	1 Ring
Communication	RJ45
Communication Cable	CAT-5e
Communication Speed	100Mbps
Communication Distance	Max. 100m
Communication Host and Slave Module	Max. 64
Motion Control Capability	Synchronous Control of up to 32/16/8 axes
Digital Input	8-CH isolated, SINK/SOURCE type, 24 V <sub>DC</sub> (5 mA/CH)
Digital Output	4-CH isolated, SINK type, 24 V <sub>DC</sub> (100 mA/CH)
Encoder Input	2-CH isolated, EA±/EB±
Compare Output	2-CH isolated · CMP± Interval: 100K · Table: 40K
Technical Indicators	PCI Spec. 2.2; supports 32-bit, 3.3/5V <sub>DC</sub> operation
Power Consumption	+5V <sub>DC</sub> at 1A typical
Environment	0°C ~ 50°C
Safety Certification	CE 

## Exterior of the Motion Control Card

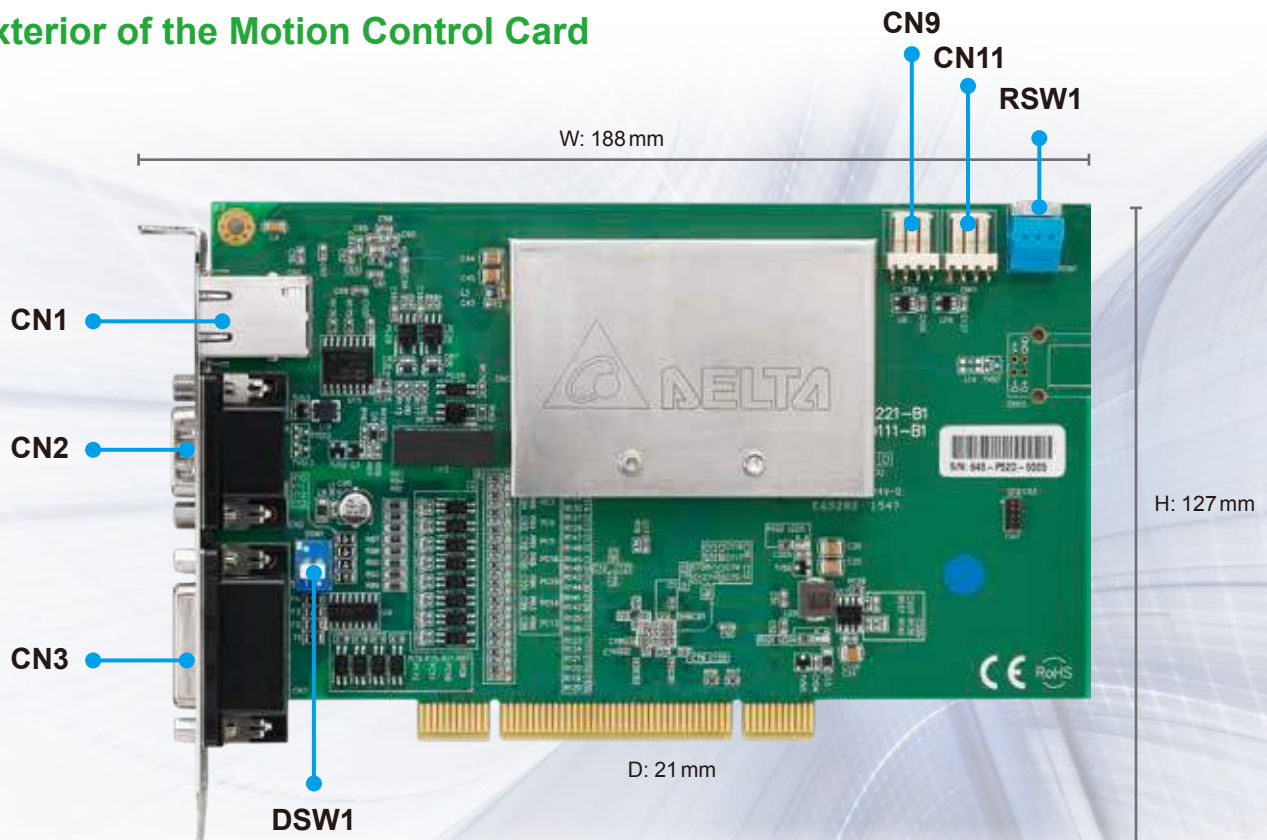

Note: This is a photo of PCI-L221-B1D0. The PCB color of PCI-L221-BF1D0 & PCI-L221-BF0D0 cards is blue.

Title	Function	Title	Function
CN1	EtherCAT Expansion Module Connection Port	CN11	Position Compare Signal Output (Channel 2, 3.3V)
CN2	Encoder & Compare Connector	RSW1	Card ID Number Configuration Switch
CN3	Digital Input/Output Connector	DSW1	Input/Output Signal SINK/SOURCE Device Switch
CN9	Position Compare Signal Output (Channel 1, 3.3V)		

### ● CN1: Expansion Module Connection Port



PIN	Label	Description
1	TX+	Transmitted Data +
2	TX-	Transmitted Data -
3	RX+	Received Data +
6	RX-	Received Data -
LED (right)	GREEN	Link/Activity

### ● CNCN2: Encoder & Compare Connector

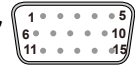

PIN	Label	Description	PIN	Label	Description
1	QA_1-	1st QA Signal (-)	9	QB_2+	2nd QB Signal (+)
2	QB_1-	1st QB Signal (-)	10	GPIO IN	GPIO Input Signal
3	QA_2-	2nd QA Signal (-)	11	CMP_1+(RS-422)	1st RS422 Differential Signal (+) 5V
4	QB_2-	2nd QB Signal (-)	12	CMP_1- (RS-422)	1st RS422 Differential Signa (-) GND
5	External GND	GND Signal	13	CMP_2+(RS-422)	2nd RS422 Differential Signal (+) 5V
6	QA_1+	1st QA Signal (+)	14	CMP_2- (RS-422)	2nd RS422 Differential Signal (-) GND
7	QB_1+	1st QB Signal (+)	15	I/O OUT	I/O Output Signal
8	QA_2+	2nd QA Signal (+)			

### ● CN3: Digital Input/Output Connector



PIN	Label	Description	PIN	Label	Description
1	I/O IN 0	I/O Input Signal	14	I/O OUT 4	I/O Output Signal
2	I/O IN 1	I/O Input Signal	15	I/O OUT 5	I/O Output Signal
3	I/O IN 2	I/O Input Signal	16	I/O OUT 6	I/O Output Signal
4	I/O IN 3	I/O Input Signal	17	I/O OUT 7	I/O Output Signal
5	I/O IN 4	I/O Input Signal	18	External GND	GND Signal
6	I/O IN 5	I/O Input Signal	19	I/O IN 8	I/O Input Signal
7	I/O IN 6	I/O Input Signal	20	I/O IN 9	I/O Input Signal
8	I/O IN 7	I/O Input Signal	21	I/O IN 10	I/O Input Signal
9	External GND	GND Signal	22	I/O IN 11	I/O Input Signal
10	I/O OUT 0	I/O Output Signal	23	I/O OUT 8	I/O Output Signal
11	I/O OUT 1	I/O Output Signal	24	I/O OUT 9	I/O Output Signal
12	I/O OUT 2	I/O Output Signal	25	I/O OUT 10	I/O Output Signal
13	I/O OUT 3	I/O Output Signal	26	I/O OUT 11	I/O Output Signal

### ● CN9: 3.3V Compare Output 1

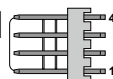

PIN	Label	Description
1	CMP_OUT1(QEP1)	Position Compare Signal Output (3.3V)
2	GND	GND Signal
3	CMP_+(LVDS)	LVDS Differential Signal (+)
4	CMP_1- (LVDS)	LVDS Differential Signal (-)

### ● CN11: 3.3V Compare Output 2

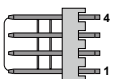

PIN	Label	Description
1	CMP_OUT2(QEP2)	Position Compare Signal Output (3.3V)
2	GND	GND Signal
3	CMP_2+(LVDS)	LVDS Differential Signal (+)
4	CMP_2- (LVDS)	LVDS Differential Signal (-)

### ● DSW1: SINK / SOURCE Loop Switch

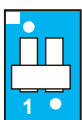

Label	Description
ON	SOURCE (Connects to PNP device)
OFF	SINK (Connects to NPN device)

### ● RSW1: Dial for Setting the Card ID Number



The number is set based on the value of the dial (between 0~15)



# EtherCAT Remote Modules

## Gateway Type E-bus Remote Power Coupler

### R1-EC5500D0

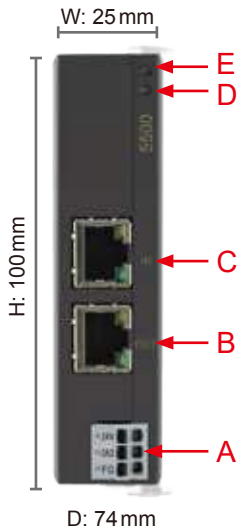

NO.	Description
A.	DC Power Input
B.	EtherCAT Output
C.	EtherCAT Input
D.	Status Indicator
E.	Power Indicator

Technical Data	R1-EC5500D0
Task Within EtherCAT System	Connect EtherCAT Slave module with 100baseTX EtherCAT
Data Transfer Medium	Ethernet/EtherCAT cable (min. CAT 5), shielded
Distance Between Stations	100 M (100BASE-TX) between two slaves
Protocol	EtherCAT
Data Transfer Rates	100 Mbaud
Bus Interface	RJ45 x 2
Input Voltage	24 V <sub>DC</sub>
Input Current	50 mA + (E-bus total E-bus current)/4
Current Supply E-Bus	2A
Electrical Isolation	500Vrms (Power contact/Supply voltage/Ethernet)
Vibration/Shock Resistance	EN 60068-2-6/EN 60068-2-27/29
EMC Immunity	ESD (IEC 61131-2, IEC 61000-4-2): 8KV Air Discharge EFT (IEC 61131-2, IEC 61000-4-4): Power Line: 2KV Communication I/O: 1KV RS (IEC 61131-2, IEC 61000-4-3): 80MHz ~ 1 GHz, 10V/m
Operating Environment	Operating temperature: 0 °C ~ 50 °C Storage temperature: -20 °C ~ 70 °C
Weight	55g
Protection Class	IP20
Safety Certification	CE 
Mounting Type	DIN-rail

# 1-Channel Pulse Output Remote Module

R1-EC5621D0

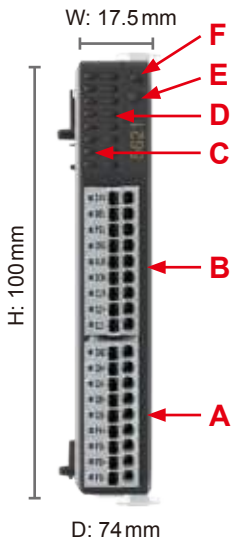

NO.	Description	No.	Description
A.	I/O Signal Port	D.	I/O Signal Indicator
B.	I/O Signal Port	E.	Status Indicator
C.	I/O Signal Indicator	F.	Power Indicator

Input	Description	Input	Description
24V	24V Power	GND	External Ground
MEL	End Limit (-)	QA+	Encoder A Phase (+)
PEL	End Limit (+)	QA-	Encoder A Phase (-)
ORG	Home Signal	QB+	Encoder B Phase (+)
ALM	Servo Alarm	QB-	Encoder B Phase (-)
SON	Servo On	PA+	Pulse Signal (+)
CLR	Reset Servo Alarm	PA-	Pulse Signal (-)
QZ+	Encoder Z Phase (+)	PB+	Dir. Signal (+)
QZ-	Encoder Z Phase (-)	PB-	Dir. Signal (-)

Technical Data	R1-EC5621D0
Number of Outputs	1 channel (PA+, PA-, PB+, PB-)
Number of Inputs	1 channel (QA+, QA-, QB+, QB-, QZ+, QZ-)
Power Supply	Supplied by E-bus
Signal Voltage	RS-422 standards
Max. Output Current	RS-422 standards
Base Frequency	1Hz ~ 4MHz
Numbers of 24V Input	4 (MEL, PEL, ORG, ALM)
Numbers of 24V Output	2 (CLR, SON)
Trigger Voltage (On > Off)	< 8V <sub>DC</sub>
Trigger Voltage (Off > On)	> 16.5V <sub>DC</sub>
Maximum Current of Each Output Port	30mA
Current Consumption E-Bus	150mA
Electrical Isolation	500Vrms (E-bus/field potential)
Bit Width in the Process Image	32 byte in/out (1 x 16 byte data, 1 x 16 byte control/status)
Vibration/Shock Resistance	EN 60068-2-6/EN 60068-2-27/29
EMC Immunity	ESD (IEC 61131-2, IEC 61000-4-2): 8KV Air Discharge EFT (IEC 61131-2, IEC 61000-4-4): Power Line: 2KV Communication I/O: 1KV RS (IEC 61131-2, IEC 61000-4-3): 8MHz ~ 1GHz, 10V/m
Operating Environment	Operating temperature: 0°C ~ 50°C Storage temperature: -20°C ~ 70°C
Weight	Approx. 60g
Protection Class	IP20
Safety Certification	CE 
Mounting Type	DIN-rail

# EtherCAT Remote Modules

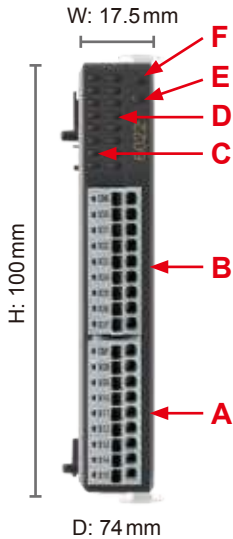

## 16-Channel Input Remote Module

R1-EC6002D0 / R1-EC6022D0



NO	Description	NO.	Description
A.	Port 1 Terminals	D.	Port 1 I/O Signal X08~X15(From the top)
B.	Port 0 Terminals	E.	Status Indicator
C.	Port 0 I/O Signal X00~X07 (From the top)	F.	Power Indicator

Input	Description	Input	Description
CM0	Port 0 COM	CM1	Port1 COM
X00	Input 0	X08	Input 8
X01	Input 1	X09	Input 9
X02	Input 2	X10	Input 10
X03	Input 3	X11	Input 11
X04	Input 4	X12	Input 12
X05	Input 5	X13	Input 13
X06	Input 6	X14	Input 14
X07	Input 7	X15	Input 15

Technical Data	R1-EC6002D0	R1-EC6022D0
Connection Technology	single-ended	
Number of Inputs	16	
Nominal Voltage	24V <sub>DC</sub> ± 10%	
Signal Type	SINK/SOURCE	
Trigger Voltage (On > Off)	< 8V <sub>DC</sub>	
Trigger Voltage (Off > On)	> 16.5V <sub>DC</sub>	
Input Filter	100 μs	2ms
Input Current	3mA at each port	
Current Consumption E-Bus	110mA	
Electrical Isolation	500 V <sub>rms</sub> (E-bus/field potential)	
Bit Width in the Process Image	16 inputs	
Vibration/Shock Resistance	EN 60068-2-6/EN 60068-2-27/29	
EMC Immunity	ESD (IEC 61131-2, IEC 61000-4-2): 8KV Air Discharge EFT (IEC 61131-2, IEC 61000-4-4): Power Line: 2KV Communication I/O: 1KV RS (IEC 61131-2, IEC 61000-4-3): 80MHz ~ 1GHz, 10V/m	
Operating Environment	Operating temperature: 0°C ~ 50°C Storage temperature: -20°C ~ 70°C	
Weight	55g	
Protection Rating	IP20	
Safety Certification	 	
Mounting Type	DIN-rail	

## 16-Channel Output Remote Module

R1-EC7062D0/R1-EC70E2D0/R1-EC70A2D0/R1-EC70F2D0

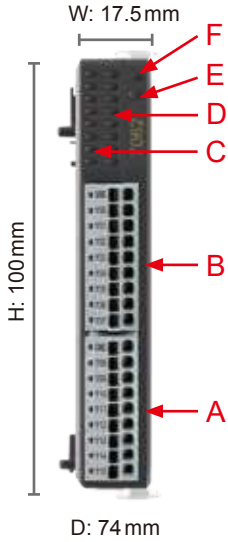



NO.	Description	NO.	Description
A.	Port 1 Terminals	D.	Port 1 I/O Signal Y08~Y15(From the top)
B.	Port 0 Terminals	E.	Status Indicator
C.	Port 0 I/O Signal Y00~Y07(From the top)	F.	Power Indicator

Output	Description	Output	Description
GND*	Port 0 GND	GND	Port 1 GND
24V**	Port 0 24V Input		
Y00	Input 0	Y08	Input 8
Y01	Input 1	Y09	Input 9
Y02	Input 2	Y10	Input 10
Y03	Input 3	Y11	Input 11
Y04	Input 4	Y12	Input 12
Y05	Input 5	Y13	Input 13
Y06	Input 6	Y14	Input 14
Y07	Input 7	Y15	Input 15

\* R1-EC7062D0/R1-EC70E2D0

\*\* R1-EC70A2D0/R1-EC70F2D0

Technical Data	R1-EC7062D0	R1-EC70E2D0	R1-EC70A2D0	R1-EC70F2D0
Connection Technology	MOSFET			
Signal Type	SINK		SOURCE	
Nominal Voltage	24V <sub>DC</sub>			
User-defined Output Disconnection	X	✓	X	✓
Input Current	0.5A (Max.)	0.25A (Max.)		
Current Consumption E-Bus	120mA	200mA		
Response Time/Frequency	1 kHz			
Trigger Time (OFF > ON)	140 μs		160 μs	
Trigger Time (ON > OFF)	150 μs		110 μs	
EMC Immunity	ESD (IEC 61131-2, IEC 61000-4-2): 8 KV Air Discharge EFT (IEC 61131-2, IEC 61000-4-4): Power Line: 2KV Communication I/O: 1KV RS (IEC 61131-2, IEC 61000-4-3): 80 MHz ~ 1GHz, 10V/m			
Operating Environment	Operating temperature: 0°C ~ 50°C Storage temperature : -20°C ~ 70°C			
Weight	Approx. 60g			
Protection Rating	IP20			
Safety Certification	 			
Mounting Type	DIN-rail			



# EtherCAT Remote Modules

## 4-Channel Analog Input Remote Module

R1-EC8124D0

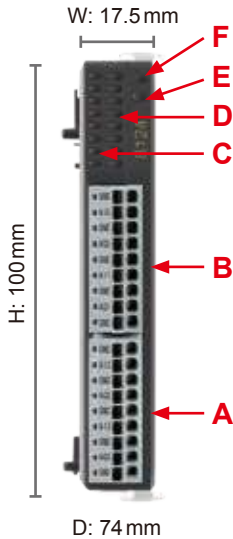

NO.	Description	NO.	Description
A.	CH3/CH4 Signal Port	D.	CH3/CH4 Signal Indicator
B.	CH1/CH2 Signal Port	E.	Status Indicator
C.	CH1/CH2 Signal Indicator	F.	Power Indicator

Input	Description	Input	Description
GND	Analog Ground	GND	Analog Ground
AI0	CH1 Voltage/Current Input	AI2	CH3 Voltage/Current Input
GND	Analog Ground	GND	Analog Ground
AG0	CH1 Current COM*	AG2	CH3 Current COM*
GND	Analog Ground	GND	Analog Ground
AI1	CH2 Voltage/Current Input	AI3	CH4 Voltage/Current Input
GND	Analog Ground	GND	Analog Ground
AG1	CH2 Current COM*	AG3	CH4 Current COM*
GND	Analog Ground	GND	Analog Ground

\* In current mode: please connect current COM to GND ; In voltage mode: please disconnect this COM

Technical data	R1-EC8124D0
Number of Inputs	4 (single-ended)
Power Supply	Supplied by E-bus
Signal Voltage	$\pm 10V / \pm 5V$
Internal Resistance	$> 1M\Omega$
Input Filter Limit Frequency	1 kHz ~ 10 kHz
Resolution	16 bit
Over Sampling Rate	0 ~ 64
Conversion Time	$2\mu s \sim 191\mu s$ (depends on Over Sampling Rate)
Measuring Error	$< \pm 0.2\%$ (relative to full scale value)
Electrical Isolation	1,000Vrms (E-bus/signal voltage)
Current Consumption E-Bus	300 mA
Bit Width in the Process Image	Input: 4 x 16 byte data, 4 x 16 byte control/status
Vibration/Shock Resistance	60068-2-6/EN 60068-2-27/29
EMC Immunity	ESD (IEC 61131-2, IEC 61000-4-2): 8 KV Air Discharge EFT (IEC 61131-2, IEC 61000-4-4): Power Line: 2KV Communication I/O: 1KV RS (IEC 61131-2, IEC 61000-4-3): 8 MHz ~ 1 GHz, 10V/m
Operating Environment	Operating temperature: $0^{\circ}C \sim 50^{\circ}C$ Storage temperature: $-20^{\circ}C \sim 70^{\circ}C$
Weight	Approx. 60g
Protection Rating	IP20
Safety Certification	CE
Mounting Type	DIN-rail

## 4-Channel Analog Output Remote Module

### R1-EC9144D0

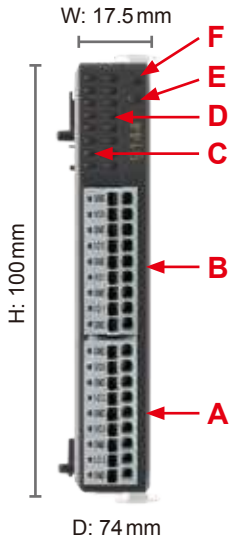

NO.	Description	NO.	Description
A.	CH3/CH4 Signal Port	D.	CH3/CH4 Signal Indicator
B.	CH1/CH2 Signal Port	E.	Status Indicator
C.	CH1/CH2 Signal Indicator	F.	Power Indicator

Output	Description	Output	Description
GND	Analog Ground	GND	Analog Ground
VO0	CH1 Voltage Output	VO2	CH3 Voltage Output
GND	Analog Ground	GND	Analog Ground
IO0	CH1 Current Output	IO2	CH3 Current Output
GND	Analog Ground	GND	Analog Ground
VO1	CH2 Voltage Output	VO3	CH4 Voltage Output
GND	Analog Ground	GND	Analog Ground
IO1	CH2 Current Output	IO3	CH4 Current Output
GND	Analog Ground	GND	Analog Ground

Technical Data	R1-EC9144D0
Number of Inputs	4 (single-ended)
Power Supply	Supplied by E-bus
Signal Voltage Output	$\pm 10V / \pm 5V / 0 \sim 5V / 0 \sim 10V$
Current Output	$0 \sim 20\text{mA} / 4 \sim 24\text{mA} / 0 \sim 24\text{mA}$
Load	$> 1\text{k}\Omega$ (short-circuit-proof)
Resolution	16 bit
Conversion Time	80 $\mu\text{s}$
Measuring Error	$< \pm 0.2\%$ (relative to full scale value) voltage output $< \pm 0.3\%$ (relative to full scale value) current output
Electrical Isolation	1,000 Vrms (E-bus/signal voltage)
Current Consumption E-Bus	550 mA
Bit Width in the Process Image	Output: 4 x 16 byte, (4 x 16-bit analog output)
Vibration/Shock Resistance	EN 60068-2-6/EN 60068-2-27/29
EMC Immunity	ESD (IEC 61131-2, IEC 61000-4-2): 8 KV Air Discharge EFT (IEC 61131-2, IEC 61000-4-4): Power Line: 2 KV Communication I/O: 1 KV RS (IEC 61131-2, EC 61000-4-3): 8 MHz $\sim$ 1 GHz, 10V/m
Operating Environment	Operating temperature: $0^\circ\text{C} \sim 50^\circ\text{C}$ Storage temperature: $-20^\circ\text{C} \sim 70^\circ\text{C}$
Weight	Approx. 60g
Protection Rating	IP20
Safety Certification	CE 
Mounting Type	DIN-rail

# EtherCAT Remote Modules

## Manual Pulse Generator (MPG) Module

R1-EC5614D0

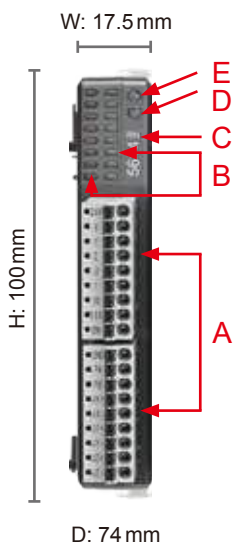

NO.	Description	NO.	Description
A.	IO Signal Port	D.	Status Indicator
B.	I/O Signal Indicator	E.	Power Indicator
C.	Product No.		

Input	Description	Input	Description
GND	External Ground	24V	External Power Input
PA	MPG Pulse Phase A Input	X	X-axis Pulse Chosen Signal
PB	MPG Pulse Phase B Input	Y	Y-axis Pulse Chosen Signal
JX+	JOG X-axis Signal (+)	Z	Z-axis Pulse Chosen Signal
JX-	JOG X-axis Signal (-)	U	U-axis Pulse Chosen Signal
JY+	JOG Y-axis Signal (+)	1	Pulse Magnification (x 1)
JY-	JOG Y-axis Signal (-)	10	Pulse Magnification (x 10)
JZ+	JOG Z-axis Signal (+) / *W-axis	100	Pulse Magnification (x 100)
JZ-	JOG Z-axis Signal (-) / *V-axis	EN	Motion/Setting Execution

\*Supports 6-axis MPG via software: JZ+ needs to connect to W-axis signal; JZ- needs to connect to V-axis signal

Technical Data	R1-EC5614D0
Control Axes	4/6 axes
Power Supply	Supplied by E-bus
Pulse Magnification	x1/x10/x100
JOG Input	3/2 sets
Sampling Rate	40kHz
FIFO Length	30 sets
Communication Time	125µs - 3,276,800µs
Trigger Time (ON > OFF)	< 8V <sub>DC</sub>
Trigger Time (OFF > ON)	> 16.5V <sub>DC</sub>
Current Consumption E-Bus	180mA
Electrical Isolation	500Vrms (E-bus/Signal Power)
Vibration / Shock Resistance	Compliant with EN 60068-2-6/EN 60068-2-27/29
EMC Immunity	ESD (IEC 61131-2, IEC 61000-4-2) EFT (IEC 61131-2, IEC 61000-4-4) RS (IEC 61131-2, EC 61000-4-3)
Operating Environment	Operating temperature: 0°C ~ 50°C Storage temperature: -20°C ~ 70°C
Weight	Approx. 55g
Protection Class	IP20
Safety Certification	CE 
Mounting Type	DIN-rail

# EtherCAT Remote Modules

## Digital Input / Output Module

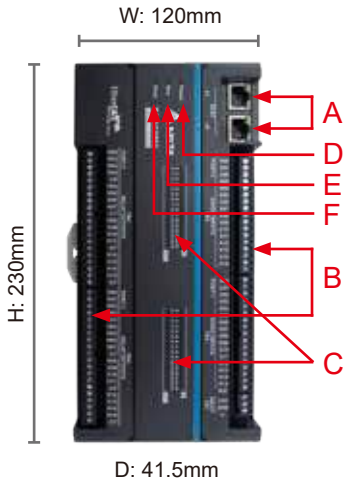

R2-EC0902D0



NO.	Description	NO.	Description
A.	EtherCAT DI/DO Terminals	D.	Power Indicator
B.	GPIO DI/DO Terminals	E.	Communication Indicator
C.	GPIO Status Indicator	F.	Alarm Indicator

DI/DO	Description	DI/DO	Description
X00	Port 0 Input 1	24V	External Power Supply Input
...	...		
X15	Port 0 Input 16	GND	External Power Ground
N.C	Reserved		
X00	Port 1 Input 1	FG	Ground
...	...		
X15	Port 1 Input 16		
S/S*	NPN / PNP Setting		
Y00	Port 2 Input 1		
...	...		
Y15	Port 2 Input 16		
Y00	Port 3 Input 1		
...	...		
Y15	Port 3 Input 16		

\*1: S/S: NPN/PNP Setting, NPN = V<sub>cc</sub>, PNP = GND

Technical Data	R2-EC0902D0	
Nominal Voltage	24 V <sub>DC</sub> -15% ~+20%	
Input Current	< 1 A	
Digital I/O	Digital Input	Digital Output
Insolation	Optical Coupler	Relay
Signal Type	Sink/Source	A (N.O) Dry Contact
I/O Terminals	32-CH	32-CH
Max. Operating Voltage/Current	30 V <sub>DC</sub> @ 8mA/Per CH	30 V <sub>DC</sub> @ 2A/Per CH 250 V <sub>AC</sub> @ 2A/Per CH
Rated Input Voltage/Current	24 V <sub>DC</sub> @ 5mA	-
Frequency	1 kHz	1 Hz
Response Time (Operation) (OFF > ON)	300 μs	10 ms
Response Time (Release) (ON > OFF)	300 μs	5 ms
Relay ON/OFF Times	-	Inductive: 20,000 Times @ 30 V <sub>DC</sub> 2A Resistive: 100,000 Times @ 30 V <sub>DC</sub> , 250 V <sub>AC</sub> 2A
Dimensions	230 x 120 x 41.5 mm (W x H x D)	
Operating Environment	Operating Temperature: 0°C ~ 50°C (32° F ~ 122° F) ; Storage Temperature: -20°C ~ 70°C (-4° F ~ 158° F)	
Mounting Type	DIN-rail	
Vibration / Shock Resistance	Compliant with EN 60068-2-6/EN 60068-2-27/29	
EMC Immunity	ESD (IEC 61131-2, IEC 61000-4-2) EFT (IEC 61131-2, IEC 61000-4-4) RS (IEC 61131-2, IEC 61000-4-3)	
Protection Rating	IP20	
Safety Certification	 	



# DMCNET Motion Control Card

- Standard Type PCI-DMC-A02

## Specifications

Model Name	PCI-DMC-A02
Supporting Module	Delta Servo Drive ASDA-A3-F/ASDA-A2-F/ASDA-B3-F/ASDA-B2-F Series
Homing Mode	35 types (Parameter Setting via DMCNET)
Velocity Profiles	T-curve, S-curve
Interpolation Mode	Linear, Arc, Helical and Continuous
Ring	1 Ring
Supporting Languages	VB, VC, BCB, Delphi, C#, VB.NET, Labview
Communication Cable	Category 5e STP Ethernet Cable (24AWG/4Pairs)
Communication Distance	Max. 30m (12 slave modules)
Communication Interface	Half duplex RS-485 with transformer isolation
PCI Specifications	ver.2.2, supports 32-bit, 3.3V/5V <sub>DC</sub> operation
Power Consumption	+5V DC at 1A typical
Environment	Operating Temperature: 0°C ~ 50°C ; Storage Temperature: -20°C ~ 70°C Humidity: 5~95% (non-condensing)
Maximum Axes	12
Maximum Number of Modules	12
Digital Input	32-CH isolated, SINK/SOURCE type, 24 V <sub>DC</sub> (5 mA /CH)
Digital Output	24-CH isolated, SINK type, 24 V <sub>DC</sub> (100 mA /CH)
Noise Tolerance	Withstand (Peak) voltage: 1,500 V <sub>AC</sub> (Primary-secondary); 1,500 V <sub>AC</sub> (Primary-PE) ESD (IEC 61131-2, IEC 61000-4-2): 8KV Air Discharge EFT (IEC 61131-2, IEC 61000-4-4): Power Line: 2KV, Communication I/O: 1KV RS (IEC 61131-2, IEC 61000-4-3): 26MHz~1GHz, 10V/m

## Exterior of the Motion Control Card

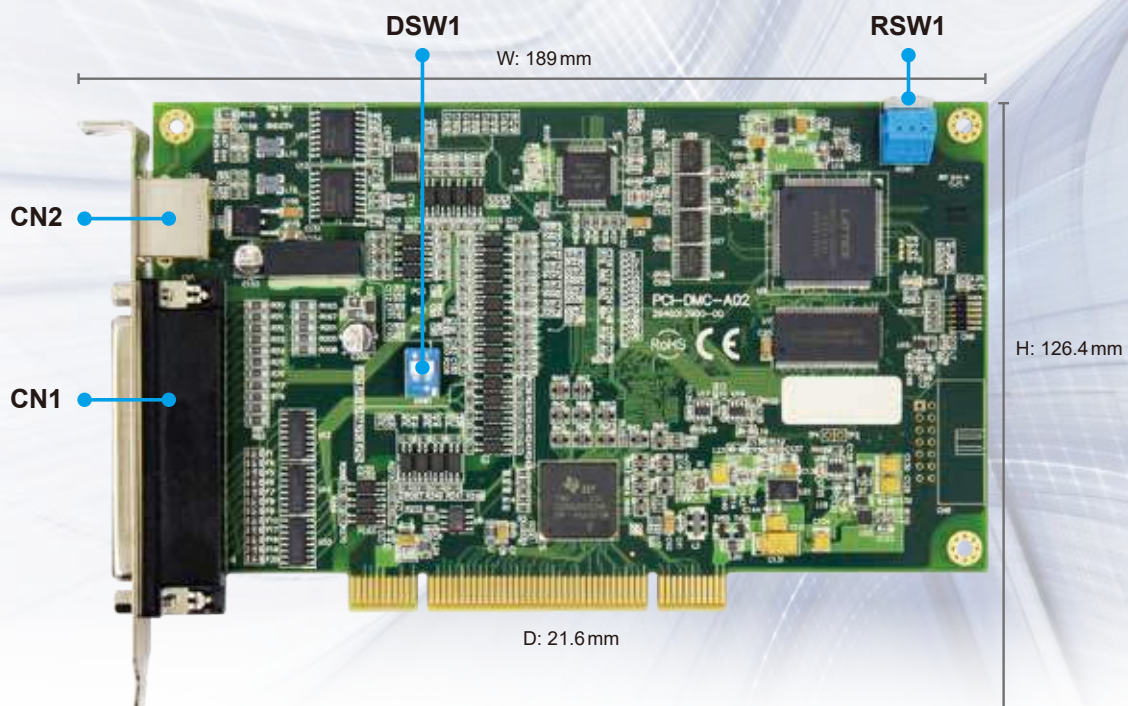

Title	Function
CN1	Digital Input/Output Connector
CN2	DMCNET Expansion Module Connection Port
RSW1	Card ID Number Configuration Switch
DSW1	Input/Output Signal SINK/SOURCE Device Switch

## ● CN1: Digital Input/Output Connector

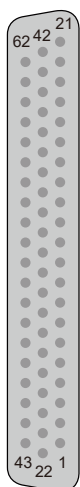

PIN	Description	PIN	Description	PIN	Description
1	I/O Output Signal 7	22	I/O Output Signal 16	43	I/O Output Signal 23
2	I/O Output Signal 6	23	I/O Output Signal 15	44	I/O Output Signal 22
3	I/O Output Signal 5	24	I/O Output Signal 14	45	I/O Output Signal 21
4	I/O Output Signal 4	25	I/O Output Signal 13	46	I/O Output Signal 20
5	I/O Output Signal 3	26	I/O Output Signal 12	47	I/O Output Signal 19
6	IO Output Signal 2	27	I/O Output Signal 11	48	I/O Output Signal 18
7	I/O Output Signal 1	28	I/O Output Signal 10	49	I/O Output Signal 17
8	I/O Output Signal 0	29	I/O Output Signal 9	50	24V <sub>DC</sub> Power
9	GND Signal	30	I/O Output Signal 8	51	EGND Signal
10	GND Signal	31	GND Signal	52	I/O Input Signal 31
11	I/O Input Signal 10	32	GND Signal	53	I/O Input Signal 30
12	I/O Input Signal 9	33	I/O Input Signal 20	54	I/O Input Signal 29
13	I/O Input Signal 8	34	I/O Input Signal 19	55	I/O Input Signal 28
14	I/O Input Signal 7	35	I/O Input Signal 18	56	I/O Input Signal 27
15	I/O Input Signal 6	36	I/O Input Signal 17	57	I/O Input Signal 26
16	I/O Input Signal 5	37	I/O Input Signal 16	58	I/O Input Signal 25
17	I/O Input Signal 4	38	I/O Input Signal 15	59	I/O Input Signal 24
18	I/O Input Signal 3	39	I/O Input Signal 14	60	I/O Input Signal 23
19	I/O Input Signal 2	40	I/O Input Signal 13	61	I/O Input Signal 22
20	I/O Input Signal 1	41	I/O Input Signal 12	62	I/O Input Signal 21
21	I/O Input Signal 0	42	I/O Input Signal 11		

## ● CN2: DMCNET Expansion Module Connection Port

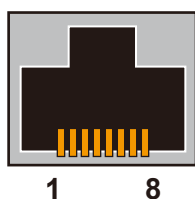

PIN	Label	Description
1	RS485T_1 (+)	1st RS485 Transmission Signal (+)
2	RS485T_1 (-)	1st RS485 Transmission Signal (-)
3	RS485T_2 (+)	2nd RS485 Transmission Signal (+)
6	RS485T_2 (-)	2nd RS485 Transmission Signal (-)
7	EGND	9V Ground Signal
8	EGND	9V Ground Signal

## ● DSW1: SINK/SOURCE Loop Switch

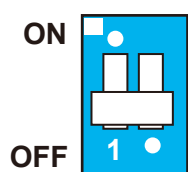

Label	Description
ON	SOURCE (connects to PNP device)
OFF	SINK (connects to NPN device)

## ● RSW1: Dial for Setting the Card ID Number

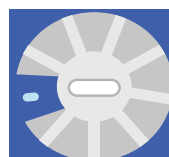

The number is set based on the value of the dial (between 0~15)

# DMCNET Motion Control Card

- Advanced Type PCI-DMC-B01

## Specifications

Model Name	PCI-DMC-B01
Supporting Module	Delta Servo Drive ASDA-A3-F/ASDA-A2-F/ASDA-B3-F/ASDA-B2-F Series
Homing Mode	35 types (Parameter Setting via DMCNET)
Velocity Profiles	T-curve, S-curve
Interpolation Mode	Linear, Arc, Helical and Continuous
Ring	1 Ring
Supporting Languages	VB, VC, BCB, Delphi, C#, VB.NET, Labview
Communication Cable	Category 5e STP Ethernet Cable (24AWG/4 Pairs)
Communication Distance	Max. 30 m (12 slave modules)
Communication Interface	Half duplex RS-485 with transformer isolation
PCI Specifications	ver.2.2, supports 32-bit, 3.3V/5V <sub>DC</sub> operation
Power Consumption	+5V <sub>DC</sub> at 0.5A typical
Environment	Operating Temperature: 0°C~50°C; Storage Temperature: -20°C~70°C Humidity: 5~95% (Non-condensing)
Maximum Axes	12
Maximum Number of Modules	12
Digital Input	1-CH isolated, SINK/SOURCE type, 24 V <sub>DC</sub> (5 mA/CH)
Digital Output	1-CH isolated, SINK type, 24 V <sub>DC</sub> (100 mA/CH)
Encoder Input	2-CH isolated, EA±/EB±
Compare Signal Output	2-CH single-ended high speed compare, CMP, Max: 200K 2-CH differential table compare, CMP±, Max: 3.6K
Noise Tolerance	Withstand (Peak) Voltage: 1,500V <sub>AC</sub> (Primary-secondary); 1,500V <sub>AC</sub> (Primary-PE) ESD (IEC 61131-2, IEC 61000-4-2): 8KV Air Discharge EFT (IEC 61131-2, IEC 61000-4-4): Power Line: 2KV, Communication I/O: 1KV RS (IEC 61131-2, IEC 61000-4-3): 26MHZ~1GHZ, 10V/m

## Exterior of the Motion Control Card

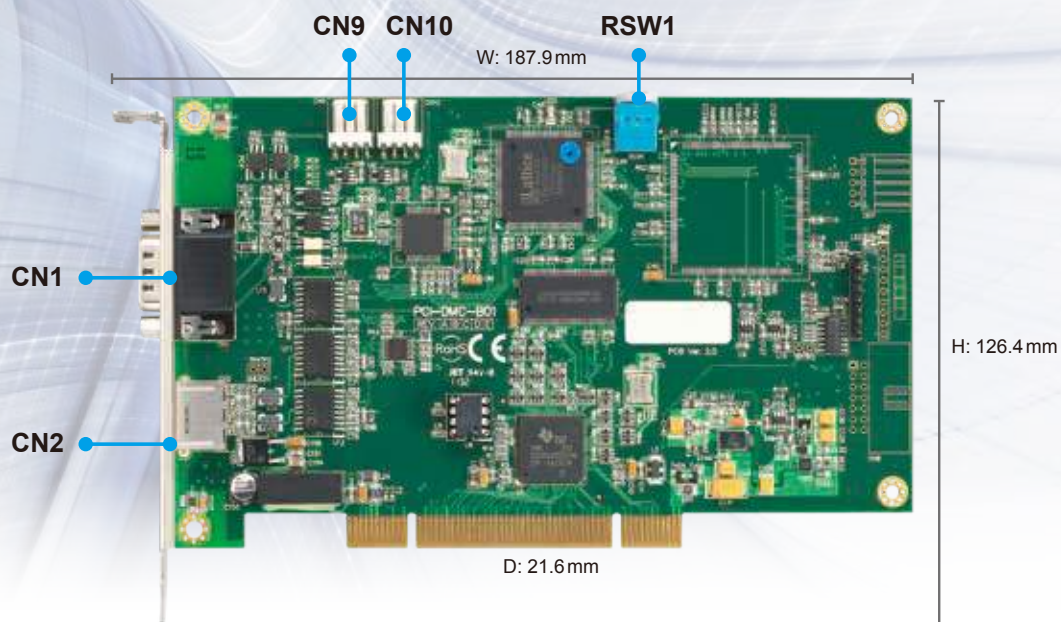

Title	Function
CN1	Connector (digital input/output, encoder & compare)
CN2	DMCNET Expansion Module Connection Port
CN9	Position compare signal output (channel 1, 3.3V)
CN10	Position compare signal output (channel 1, 3.3V)
RSW1	Card ID Number Configuration Switch

## ● CN1: Digital Input/Output

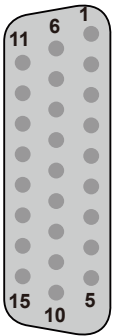

PIN	Label	Description	PIN	Label	Description
1	QA_1-	QA Signal 1 (-)	9	QB_2+	QB Signal 2 (+)
2	QB_1-	QB Signal 1 (-)	10	I/O IN	I/O Input Signal
3	QA_2-	QA Signal 2 (-)	11	CMP_1+(RS-422)	1st RS422 Differential Signal (+)
4	QB_2-	QB Signal 2 (-)	12	CMP_1- (RS-422)	1st RS422 Differential Signal (-)
5	External GND	GND Signal	13	CMP_2+(RS-422)	2nd RS422 Differential Signal (+)
6	QA_1+	QA Signal 1 (+)	14	CMP_2- (RS-422)	2nd RS422 Differential Signal (-)
7	QB_1+	QB Signal 1 (+)	15	I/O OUT	I/O Output signal
8	QA_2+	QA Signal 2 (+)			

## ● CN2: DMCNET Expansion Module Connection Port

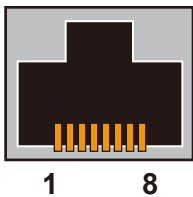

PIN	Label	Description
1	RS485T_1 (+)	1st RS485 transmission signal (+)
2	RS485T_1 (-)	1st RS485 transmission signal (-)
3	RS485T_2 (+)	2nd RS485 transmission signal (+)
6	RS485T_2 (-)	2nd RS485 transmission signal (-)
7	EGND	9V Ground Signal
8	EGND	9V Ground Signal

## ● CN9: 3.3V Compare Output 1 ● CN10: 3.3V Compare Output 2

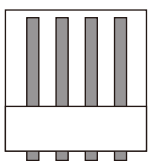

PIN	Label	Description	PIN	Label	Description
1	CMP_OUT1(QEP1)	CMOS 3.3V to level comparison trigger signal output	1	CMP_OUT2(QEP2)	CMOS 3.3V to level comparison trigger signal output
2	GND	GND Signal	2	GND	GND Signal
3	CMP_1+(LVDS)	LVDS Differential Signal (+)	3	CMP_2+(LVDS)	LVDS Differential Signal (+)
6	CMP_1- (LVDS)	LVDS Differential Signal (-)	6	CMP_2- (LVDS)	LVDS Differential Signal (-)

## ● RSW1: Dial for Setting the Card ID Number



The number is set based on the value of the dial (between 0~15)



# DMCNET Motion Control Card

## Advanced Type PCI-DMC-B02 Specifications

Model Name	PCI-DMC-B02
Supporting Module	Delta Servo Drive ASDA-A3-F/ASDA-A2-F/ASDA-B3-F/ASDA-B2-F Series
Homing Module	35 types (Parameter setting via DMCNET)
Velocity Profiles	T-curve, S-curve
Interpolation Mode	Linear, Arc, Helical and Continuous
Ring	1 Ring
Supporting Languages	VB, VC, BCB, Delphi, C#, VB.NET, Labview
Communication Cable	Category 5e STP Ethernet Cable (24AWG/4 Pairs)
Communication Distance	Max. 30m (12 slave modules)
Communication Interface	Half duplex RS-485 with transformer isolation
PCI Specifications	ver. 2.2; supports 32-bit, 3.3V/5V <sub>DC</sub> operation
Power Consumption	+5V <sub>DC</sub> at 1A typical
Environment	Operating Temperature: 0°C~50°C ; Storage Temperature: -20°C~70°C Humidity: 5~95% RH (Non-condensing)
Maximum Axes	12
Maximum Number of Modules	12
Digital Input	8-CH isolated, SINK/SOURCE type, 24V <sub>DC</sub> (5mA/CH)
Digital Output	4-CH isolated, SINK, 24V <sub>DC</sub> (100mA/CH)
Encoder Input	3-CH isolated, EA±/EB±
Compare Signal Output	4-CH single-ended high-speed compare, CMP, Max: 40K 6-CH differential table compare, CMP±, Max: 40K
Noise Tolerance	Withstand (Peak) Voltage: 1,500V <sub>AC</sub> (Primary-secondary); 1,500V <sub>AC</sub> (Primary-PE) ESD (IEC 61131-2, IEC61000-4-2): 8KV Air Discharge EST (IEC 61131-2, IEC61000-4-4): Power Line: 2KV, Communication I/O: 1KV RS (IEC 61131-2, IEC61000-4-3): 26MHz~1GHz, 10V/m

## Exterior of the Motion Control Card

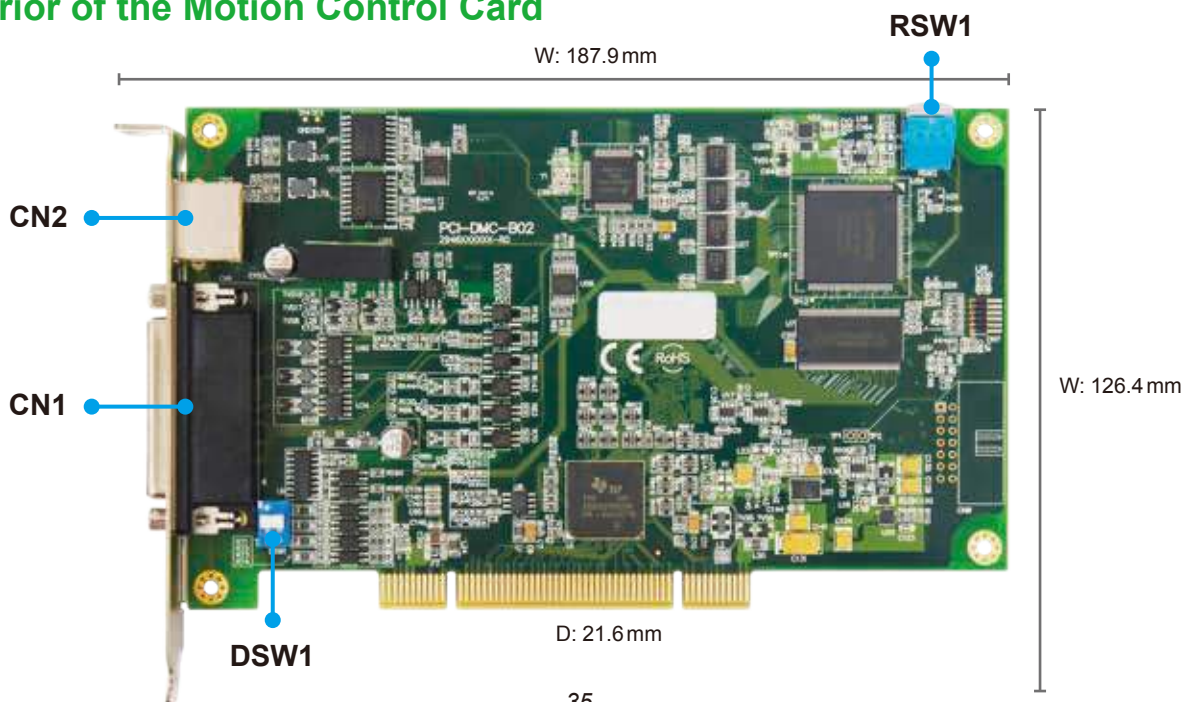

Title	Function
CN1	Connector (digital input/output, encoder & compare)
CN2	DMCNET Expansion Module Connection Port
RSW1	Card ID Number Configuration Switch
DSW1	Input / Output Signal SINK / SOURCE Device Switch

## ● CN1: Digital Input / Output

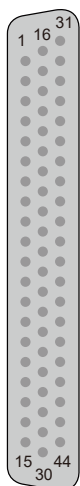

PIN	Description	PIN	Description	PIN	Description
1	QA_1-	16	QA_1+	0	IN_1
2	QB_1-	17	QB_1+	32	IN_2
3	QA_2-	18	QA_2+	33	IN_3
4	QB_2-	19	QB_2+	34	IN_4
5	QA_3-	20	QA_3+	35	IN_5
6	QB_3-	21	QB_3+	36	IN_6
7	CMP_1-	22	CMP_1+	37	IN_7
8	CMP_2-	23	CMP_2+	38	IN_8
9	CMP_3-	24	CMP_3+	39	OUT_1
10	CMP_4-	25	CMP_4+	40	OUT_2
11	CMP_5-	26	CMP_5+	41	OUT_3
12	CMP_6-	27	CMP_6+	42	OUT_4
13	CMP_7	28	CMP_8	43	E24V
14	CMP_9	29	CMP_10	44	E24V
15	EGND	30	EGND		

## ● CN2: DMCNET Expansion Module Connection Port

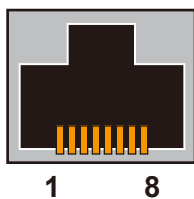

PIN	Label	Description
1	RS485T_1 (+)	1st RS485 Transmission Signal (+)
2	RS485T_1 (-)	1st RS485 Transmission Signal (-)
3	RS485T_2 (+)	2nd RS485 Transmission Signal (+)
6	RS485T_2 (-)	2nd RS485 Transmission Signal (-)
7	EGND	9V Ground Signal
8	EGND	9V Ground Signal

## ● RSW1: Dial for Setting the Card ID Number

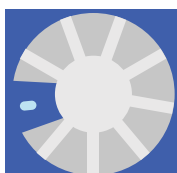

The number is set based on the value of the dial (between 0 ~ 15)

## ● DSW1: SINK / SOURCE Loop Switch

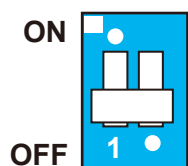

Label	Description
ON	SOURCE (connects to PNP device)
OFF	SINK (connects to NPN device)

# DMCNET Motion Control Card

- Advanced Type PCI-DMC-B03

## Specifications

Model Name	PCI-DMC-B03
Supporting Module	Delta Servo Drive ASDA-A3-F/ASDA-A2-F/ASDA-B3-F/ASDA-B2-F Series
Homing Module	35 types (Parameter setting via DMCNET)
Velocity Profiles	T-curve, S-curve
Interpolation Mode	Linear, Arc, Helical and Continuous
Ring	1 Ring
Supporting Languages	VB, VC, BCB, Delphi, C#, VB.NET, Labview
Communication Cable	Category 5e STP Ethernet Cable (24AWG/4 Pairs)
Communication Distance	Max. 30m (12 slave modules)
Communication Interface	Half duplex RS-485 with transformer isolation
PCI Specifications	ver. 2.2; supports 32-bit, 3.3V/5V <sub>DC</sub> operation
Power Consumption	+5V <sub>DC</sub> at 1A typical
Environment	Operating Temperature: 0°C~50°C ; Storage Temperature: -20°C~70°C Humidity: 5~95% RH (Non-condensing)
Maximum Axes	12
Maximum Number of Modules	12
Digital Input	8-CH isolated, SINK/SOURCE type, 24V <sub>DC</sub> (5mA/CH)
Digital Output	4-CH isolated, SINK, 24V <sub>DC</sub> (100mA/CH)
Encoder Input	3-CH isolated, EA±/EB±
Compare Signal Output	4-CH single-ended high-speed compare, CMP, Max: 100K 6-CH differential table compare, CMP±, Max: 3K
Noise Tolerance	Withstand (Peak) Voltage: 1,500V <sub>AC</sub> (Primary-secondary); 1,500V <sub>AC</sub> (Primary-PE) ESD (IEC 61131-2, IEC61000-4-2): 8KV Air Discharge EST (IEC 61131-2, IEC61000-4-4): Power Line: 2KV, Communication I/O: 1KV RS (IEC 61131-2, IEC61000-4-3): 26MHz~1GHz, 10V/m

## Exterior of the Motion Control Card

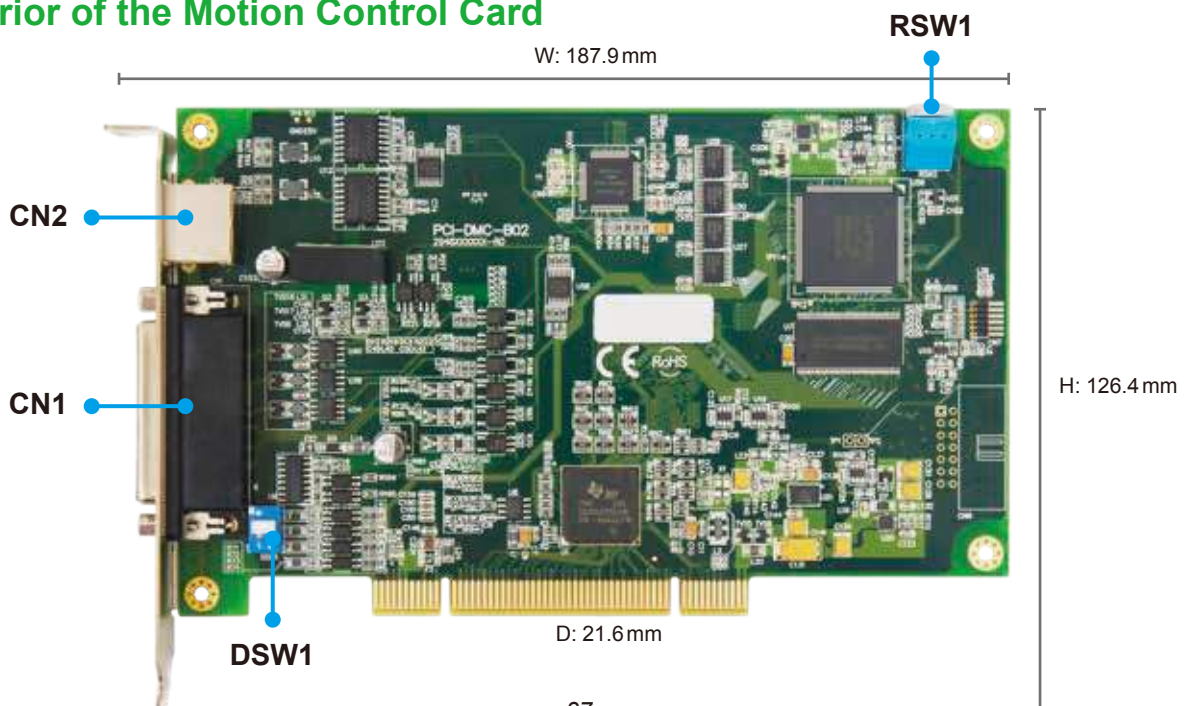

Title	Function
CN1	Connector (digital input/output, encoder & compare)
CN2	DMCNET Expansion Module Connection Port
RSW1	Card ID Number Configuration Switch
DSW1	Input/Output Signal SINK/SOURCE Device Switch

## ● CN1: Digital Input/Output

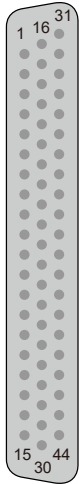

PIN	Description	PIN	Description	PIN	Description
1	QA_1-	16	QA_1+	0	IN_1
2	QB_1-	17	QB_1+	32	IN_2
3	QA_2-	18	QA_2+	33	IN_3
4	QB_2-	19	QB_2+	34	IN_4
5	QA_3-	20	QA_3+	35	IN_5
6	QB_3-	21	QB_3+	36	IN_6
7	CMP_1-	22	CMP_1+	37	IN_7
8	CMP_2-	23	CMP_2+	38	IN_8
9	CMP_3-	24	CMP_3+	39	OUT_1
10	CMP_4-	25	CMP_4+	40	OUT_2
11	CMP_5-	26	CMP_5+	41	OUT_3
12	CMP_6-	27	CMP_6+	42	OUT_4
13	CMP_7	28	CMP_8	43	E24V
14	CMP_9	29	CMP_10	44	E24V
15	EGND	30	EGND		

## ● CN2: DMCNET Expansion Module Connection Port

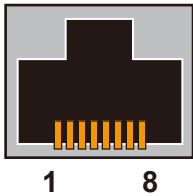

PIN	Label	Description
1	RS485T_1 (+)	1st RS485 Transmission Signal (+)
2	RS485T_1 (-)	1st RS485 Transmission Signal (-)
3	RS485T_2 (+)	2nd RS485 Transmission Signal (+)
6	RS485T_2 (-)	2nd RS485 Transmission Signal (-)
7	EGND	9V Ground Signal
8	EGND	9V Ground Signal

## ● RSW1: Dial for Setting the Card ID Number

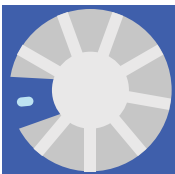

The number is set based on the value of the dial (between 0~15)

## ● DSW1: SINK/SOURCE Loop Switch

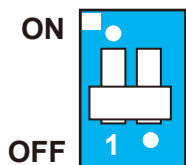

Label	Description
ON	SOURCE (connects to PNP device)
OFF	SINK (connects to NPN device)



# DMCNET Motion Control Card

- Economical Type PCI-DMC-F02

## Specifications

Model Name	PCI-DMC-F02
Supporting Module	Delta Servo Drive ASDA-A3-F/ASDA-A2-F/ASDA-B3-F/ASDA-B2-F Series
Homing Mode	35 types (Parameter Setting via DMCNET)
Velocity Profiles	T-curve, S-curve
Interpolation Mode	Linear, Arc, Helical and Continuous
Ring	1 Ring
Supporting Languages	VB, VC, BCB, Delphi, C#, VB.NET
Communication Cable	Category 5e STP Ethernet cable (24AWG/4Paris)
Communication Distance	Max. 30m (12 slave modules)
Communication Interface	Half duplex RS-485 with transformer isolation
PCI Specifications	ver.2.2, supports 32-bit, 3.3V/5V <sub>DC</sub> operation
Power Consumption	+5V <sub>DC</sub> at 0.5A typical
Environment	Operating Temperature: 0°C~50°C; Storage Temperature: -20°C~70°C Humidity: 5~95% (Non-condensing)
Maximum Axes	6
Maximum Number of Modules	12
Digital Input	32-CH isolated, SINK/SOURCE type, 24V <sub>DC</sub> (5mA/CH)
Digital Output	24-CH isolated, SINK type, 24V <sub>DC</sub> (100mA/CH)
Noise Tolerance Threshold	Withstand (Peak) Voltage: 1,500V <sub>AC</sub> (Primary-secondary); 1,500V <sub>AC</sub> (Primary-PE) ESD (IEC 61131-2, IEC61000-4-2): 8KV Air Discharge EST (IEC 61131-2, IEC61000-4-4): Power Line: 2KV, Communication I/O: 1KV RS (IEC 61131-2, IEC61000-4-3): 26MHz~1GHz, 10V/m

## Exterior of the Motion Control Card

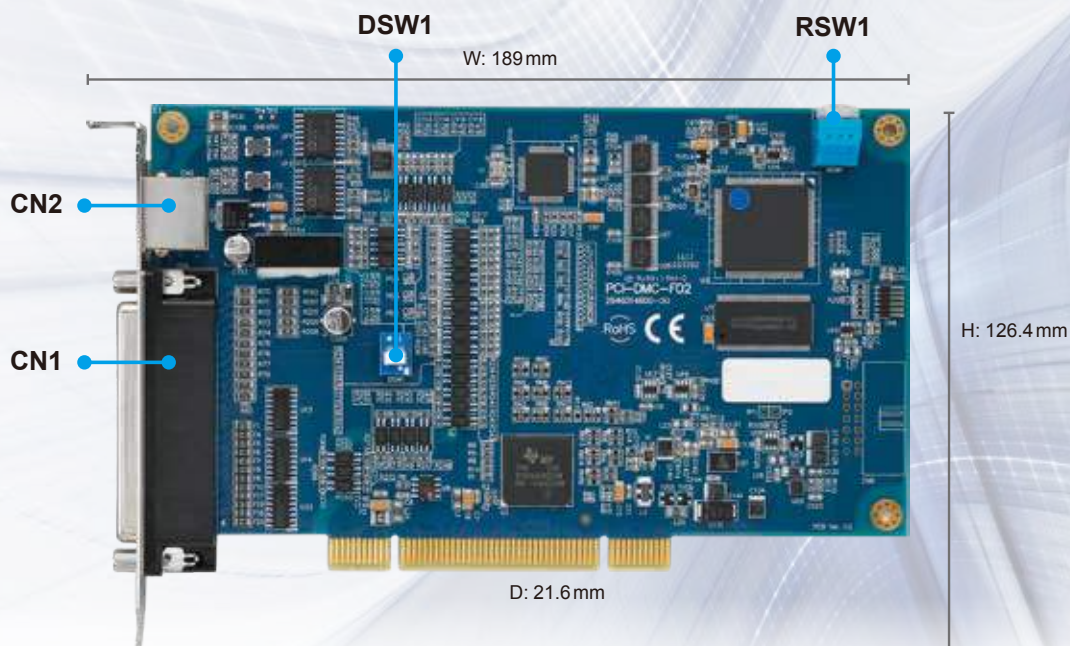



Title	Function
CN1	Digital Input/Output Connector
CN2	DMCNET Expansion Module Connection Port
RSW1	Card ID Number Configuration Switch
DSW1	Input / Output Signal SINK/SOURCE Device Switch

- CN1: Digital Input/Output Connector**

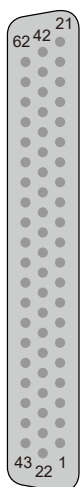

PIN	Description	PIN	Description	PIN	Description
1	I/O Output Signal 7	22	I/O Output Signal 16	43	I/O Output Signal 23
2	I/O Output Signal 6	23	I/O Output Signal 15	44	I/O Output Signal 22
3	I/O Output Signal 5	24	I/O Output Signal 14	45	I/O Output Signal 21
4	I/O Output Signal 4	25	I/O Output Signal 13	46	I/O Output Signal 20
5	I/O Output Signal 3	26	I/O Output Signal 12	47	I/O Output Signal 19
6	I/O Output Signal 2	27	I/O Output Signal 11	48	I/O Output Signal 18
7	I/O Output Signal 1	28	I/O Output Signal 10	49	I/O Output Signal 17
8	I/O Output Signal 0	29	I/O Output Signal 9	50	24 V <sub>DC</sub> Power
9	GND Signal	30	I/O Output Signal 8	51	EGND Signal
10	GND Signal	31	GND Signal	52	I/O Input Signal 31
11	I/O Input Signal 10	32	GND Signal	53	I/O Input Signal 30
12	I/O Input Signal 9	33	I/O Input Signal 20	54	I/O Input Signal 29
13	I/O Input Signal 8	34	I/O Input Signal 19	55	I/O Input Signal 28
14	I/O Input Signal 7	35	I/O Input Signal 18	56	I/O Input Signal 27
15	I/O Input Signal 6	36	I/O Input Signal 17	57	I/O Input Signal 26
16	I/O Input Signal 5	37	I/O Input Signal 16	58	I/O Input Signal 25
17	I/O Input Signal 4	38	I/O Input Signal 15	59	I/O Input Signal 24
18	I/O Input Signal 3	39	I/O Input Signal 14	60	I/O Input Signal 23
19	I/O Input Signal 2	40	I/O Input Signal 13	61	I/O Input Signal 22
20	I/O Input Signal 1	41	I/O Input Signal 12	62	IO Input Signal 21
21	I/O Input Signal 0	42	I/O Input Signal 11		

- CN2: DMCNET Expansion Module Connection Port**

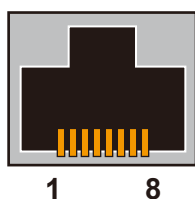

PIN	Label	Description
1	RS485T_1 (+)	1st RS485 Transmission Signal (+)
2	RS485T_1 (-)	1st RS485 Transmission Signal (-)
3	RS485T_2 (+)	2nd RS485 Transmission Signal (+)
6	RS485T_2 (-)	2nd RS485 Transmission Signal (-)
7	EGND	9V Ground Signal
8	EGND	9V Ground Signal

- DSW1: SINK/SOURCE Loop Switch**

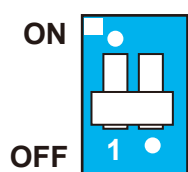

Label	Description
ON	SOURCE (connects to PNP device)
OFF	SINK (connects to NPN device)

- RSW1: Dial for Setting the Card ID Number**

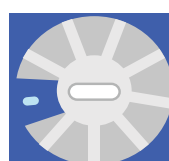

The number is set based on the value of the dial (between 0~15)

# 4-axis Pulse Motion Control Card

- 4-axis Pulse Type PCI-M324-F1D0

## Specifications

Model Name	PCI-M324-F1D0
Pulse Output Type	OUT/DIR, CW/CCW, AB phase
Pulse Output Speed	Max. 3.2Mpps
Range	32-bit ( $\pm 2,147,483,648$ pulses)
Homing Mode	35 types
Velocity Profile	T-curve, S-curve
Interpolation	Linear, circular, helix and continuous
Response Signal Counter	32-bit up/down x 4
Latch Output	LTC x 4
Compare Output	CMP x 2
Incremental Encoder Input	$\pm EA$ x 4, $\pm EB$ x 4
Encoder Index Signal Input	$\pm EZ$ x 4
Signal Input Connector	PEL x 4, MEL x 4, ORG x 4, SLD x 4
Servo Drive Input Connector	ALM x 4, SVON x 4, ALMC x 4, INP x 4, RDY x 4, ERC x 4
General Input Terminals	IN x 4
General Output Terminals	OUT x 4
Emergency Stop Input Terminals	EMG x 1
I/O PIN type	Optically isolated with 2.5KVrms on all pins
PCI Slot	PCI Spec. 2.2; supports 32-bit, 3.3/5V <sub>DC</sub> operation
Power Consumption	+5V <sub>DC</sub> at 0.5A typical
Operation Temperature	0°C~50°C

## Exterior of the Motion Control Card

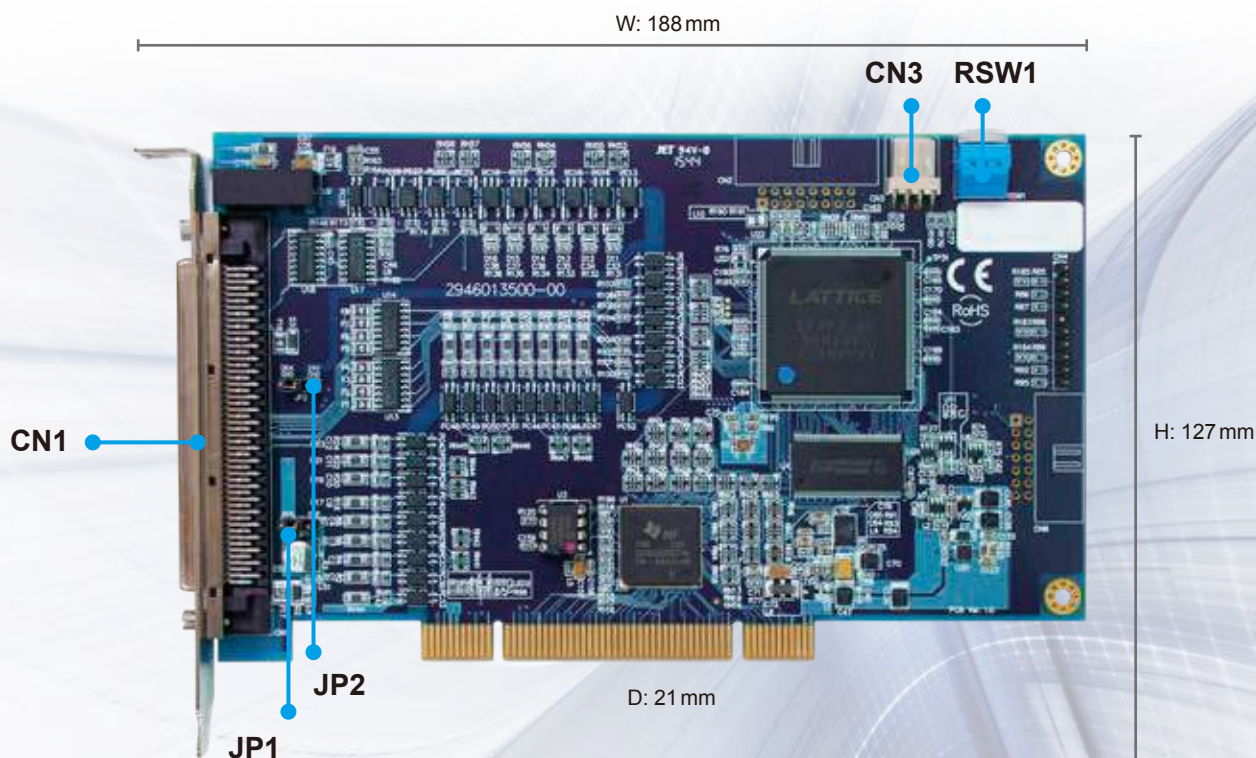

Title	Description
CN1	SCSI 100 pins, 4-axis Motion Control Input/Output Connector
CN3	Position Compare Signal Output
JP1	Jumper for Input Signal (NPN/PNP)
JP2	Jumper for Pulse Output I/O and External +24 V Grounding Signal
RSW1	Card ID Number Configuration Switch

● **CN1: Input / Output Connector**

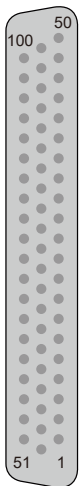

PIN	Description	PIN	Description	PIN	Description	PIN	Description
1	24V	26	ERC_2	51	24V	76	ERC_4
2	EGND	27	ALMC_2	52	EGND	77	ALMC_4
3	EMG	28	DO_2	53	EMG	78	DO_4
4	MEL_1	29	EA+_1	54	MEL_3	79	EA+_3
5	PEL_1	30	EA-_1	55	PEL_3	80	EA-_3
6	ORG_1	31	EB+_1	56	ORG_3	81	EB+_3
7	SLD_1	32	EB-_1	57	SLD_3	82	EB-_3
8	MEL_2	33	EZ+_1	58	MEL_4	83	EZ+_3
9	PEL_2	34	EZ-_1	59	PEL_4	84	EZ-_3
10	ORG_2	35	EA+_2	60	ORG_4	85	EA+_4
11	SLD_2	36	EA-_2	61	SLD_4	86	EA-_4
12	RDY_1	37	EB+_2	62	RDY_3	87	EB+_4
13	INP_1	38	EB-_2	63	INP_3	88	EB-_4
14	ALM_1	39	EZ+_2	64	ALM_3	89	EZ+_4
15	DI_1	40	EZ-_2	65	DI_3	90	EZ-_4
16	RDY_2	41	5V	66	RDY_4	91	5V
17	INP_2	42	DGND	67	INP_4	92	DGNO
18	ALM_2	43	DIR+_1	68	ALM_4	93	DIR+_3
19	DI_2	44	DIR-_1	69	DI_4	94	DIR-_3
20	EGND	45	OUT+_1	70	EGND	95	OUT+_3
21	SVON_1	46	OUT-_1	71	SVON_3	96	OUT-_3
22	ERC_1	47	DIR+_2	72	ERC_3	97	DIR+_4
23	ALMC_1	48	DIR-_2	73	ALM_3	98	DIR-_4
24	DO_1	49	OUT+_2	74	DO_3	99	OUT+_4
25	SVON_2	50	OUT-_2	75	SVON_4	100	OUT-_4

● **CN3: Position Compare Signal Output**

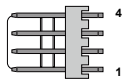

PIN	Label	Description
1	3.3V CMP_OUT	CMOS 3.3V Position Compare Signal Output
2	DGND	CMOS 3.3V Grounding Signal
3	DGND	CMOS 3.3V Grounding Signal
4	1.6(V) Vref	1.6V LVDS Voltage Reference

● **RSW1: Dial for Setting the Card ID Number**



The number is set based on the value of the dial (between 0~15)

● **JP1: Jumper for Input Signal (NPN/PNP)**



PIN	Label	Description
1	I24V	Internal +24V Voltage Connector
2	ICOM	Internal Input Signal Common Connector
3	EGND	24V Grounding Signal

● **JP2: Jumper for Pulse Output I/O and External +24V Grounding Signal**

PIN	Label	Description
1	Not use	Reserved (Not In Use)
2	IGND	DDA Pulse Grounding Signal
3	EGND	24V Grounding Signal

# Standard Data Capture Card

- Standard Type PCI-D122-XND0

## Specifications

Model Name		PCI-D122-XND0
Module Control	Function Mode	32 DI/32 DO
	Additional Mode	MPG Function
	Input	32-CH Isolated
		Sink (NPN type)/Source (PNP type)
	Output	24 V@ 5 mA
		32-CH Isolated
Sink (NPN type)		
	24 V@ 200 mA	
	PCI Card Dimensions (With Bracket)	187.9 x 126.4 x 21.6 mm (W x H x D)
	PCI Specification	Ver2.2; supports 32-bit, 3.3V/5V <sub>DC</sub> Operation
General	Power Consumption	+5V <sub>DC</sub> at 0.5A typical
	Surge Voltage Tolerance	1,500 V <sub>AC</sub> (Primary-secondary); 1,500 V <sub>AC</sub> (Primary-PE)
	ESD	8KV Air Discharge
	EFT	Power Line-2KV
	RS	80 MHz~1 GHz, 10 V/M
	Operation Temperature	0°C~50°C

## Exterior of the Motion Control Card

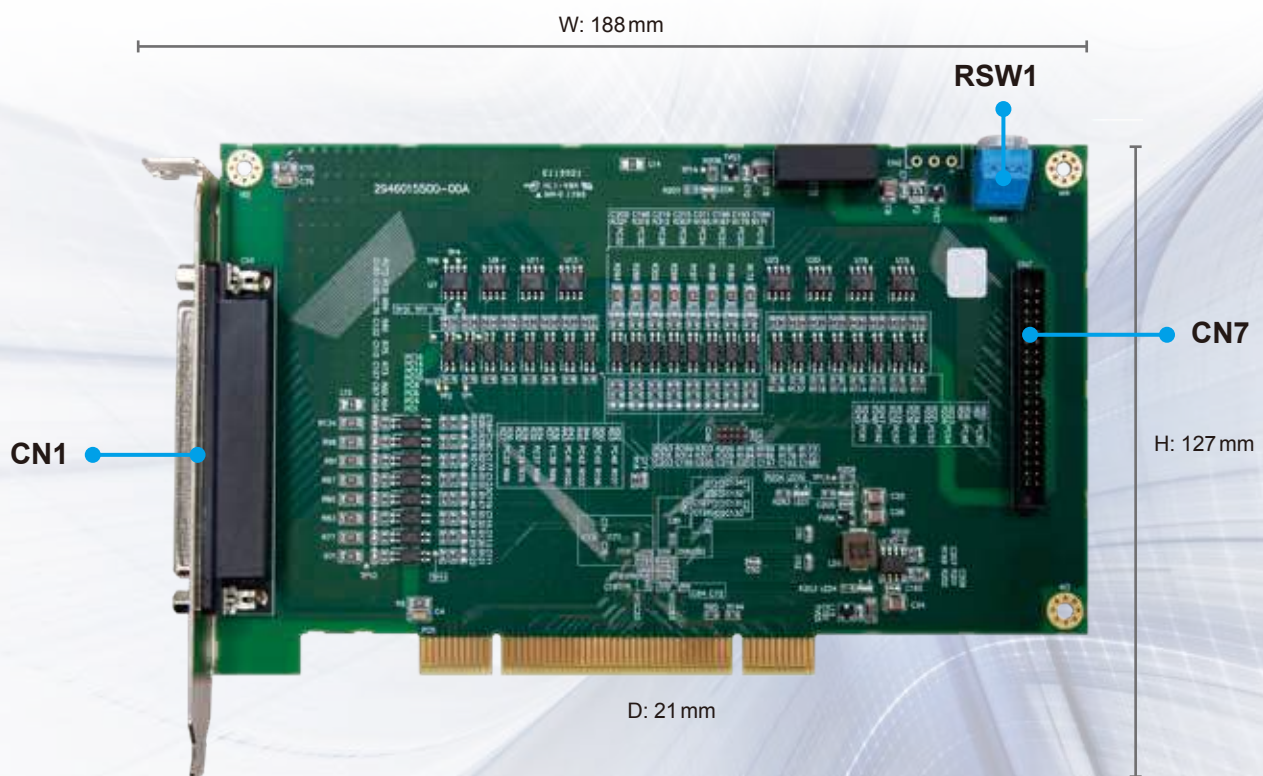



Title	Description
CN1	Input/Output Connector (CH0~CH15)
CN7	Input/Output Connector (CH16~CH31)
RSW1	Card ID Number Configuration Switch

- RSW1: Dial for Setting the Card ID Number**



The number is set based on the value of the dial (between 0~15)

- CN1: Input / Output Connector**



PIN	Label	Description	PIN	Label	Description
1	N.C	Reserved	20	GND	GND Signal
2	IN_00 *	I/O Input Signal	21	OUT_00	I/O Output Signal
3	IN_01 *	I/O Input Signal	22	OUT_01	I/O Output Signal
4	IN_02 *	I/O Input Signal	23	OUT_02	I/O Output Signal
5	IN_03 *	I/O Input Signal	24	OUT_03	I/O Output Signal
6	IN_04 *	I/O Input Signal	25	OUT_04	I/O Output Signal
7	IN_05 *	I/O Input Signal	26	OUT_05	I/O Output Signal
8	IN_06 *	I/O Input Signal	27	OUT_06	I/O Output Signal
9	IN_07 *	I/O Input Signal	28	OUT_07	I/O Output Signal
10	IN_08 *	I/O Input Signal	29	OUT_08	IO Output Signal
11	IN_09 *	I/O Input Signal	30	OUT_09	I/O Output Signal
12	IN_10 *	I/O Input Signal	31	OUT_10	I/O Output Signal
13	IN_11 *	I/O Input Signal	32	OUT_11	I/O Output Signal
14	IN_12 *	I/O Input Signal	33	OUT_12	I/O Output Signal
15	IN_13 *	I/O Input Signal	34	OUT_13	I/O Output Signal
16	IN_14 *	I/O Input Signal	35	OUT_14	I/O Output Signal
17	IN_15 *	I/O Input Signal	36	OUT_15	I/O Output Signal
18	COM_0	Common Input 0	37	N.C	Reserved
19	GND	GND Signal			

- CN7: Input / Output Connector**



PIN	Label	Description	PIN	Label	Description
1	N.C	Reserved	2	GND	GND Signal
3	IN_00 *	I/O Input Signal	4	OUT_00	I/O Output Signal
5	IN_01 *	I/O Input Signal	6	OUT_01	I/O Output Signal
7	IN_02 *	I/O Input Signal	8	OUT_02	I/O Output Signal
9	IN_03 *	I/O Input Signal	10	OUT_03	I/O Output Signal
11	IN_04 *	I/O Input Signal	12	OUT_04	I/O Output Signal
13	IN_05 *	I/O Input Signal	14	OUT_05	I/O Output Signal
15	IN_06 *	I/O Input Signal	16	OUT_06	I/O Output Signal
17	IN_07 *	I/O Input Signal	18	OUT_07	I/O Output Signal
19	IN_08 *	I/O Input Signal	20	OUT_08	I/O Output Signal
21	IN_09 *	I/O Input Signal	22	OUT_09	I/O Output Signal
23	IN_10 *	I/O Input Signal	24	OUT_10	I/O Output Signal
25	IN_11 *	I/O Input Signal	26	OUT_11	I/O Output Signal
27	IN_12 *	I/O Input Signal	28	OUT_12	I/O Output Signal
29	IN_13 *	I/O Input Signal	30	OUT_13	I/O Output Signal
31	IN_14 *	I/O Input Signal	32	OUT_14	I/O Output Signal
33	IN_15 *	I/O Input Signal	34	OUT_15	I/O Output Signal
35	COM_1	Common Input 1	36	N.C	Reserved
37	COM_1	Common Input 1	38	N.C	Reserved
39	N.C	Reserved	40	GND	GND Signal



# DMCNET Remote Modules

## Digital Input Remote Modules

- ASD-DMC-RM32MN (32 DI)
- ASD-DMC-RM64MN (64 DI)
- ASD-DMC-RM32PT (16 DI/16 DO)

## Electrical Specifications

Model Name	RM32MN / RM64MN / RM32PT
Input Circuit Type	Single common port input
Input Signal Type	SINK / SOURCE
Input Signal Voltage	24 V <sub>DC</sub> (5mA)
Response Time	0 to 3 ms, adjustable
Action Level (OFF > ON)	> 16.5 V <sub>DC</sub>
Action Level (ON > OFF)	< 8 V <sub>DC</sub>
Noise Tolerance Threshold	ESD (IEC 61131-2, IEC 61000-4-2): 8 KV Air Discharge EFT (IEC 61131-2, IEC 61000-4-4): Power Line: 2KV, Communication I/O: 1KV RS (IEC 61131-2, IEC 61000-4-3): 80MHz ~ 1GHz, 10V/m
Environment	Operating Temperature: 0°C ~ 50°C Storage Temperature: -20°C ~ 70°C

## Installation & Wiring

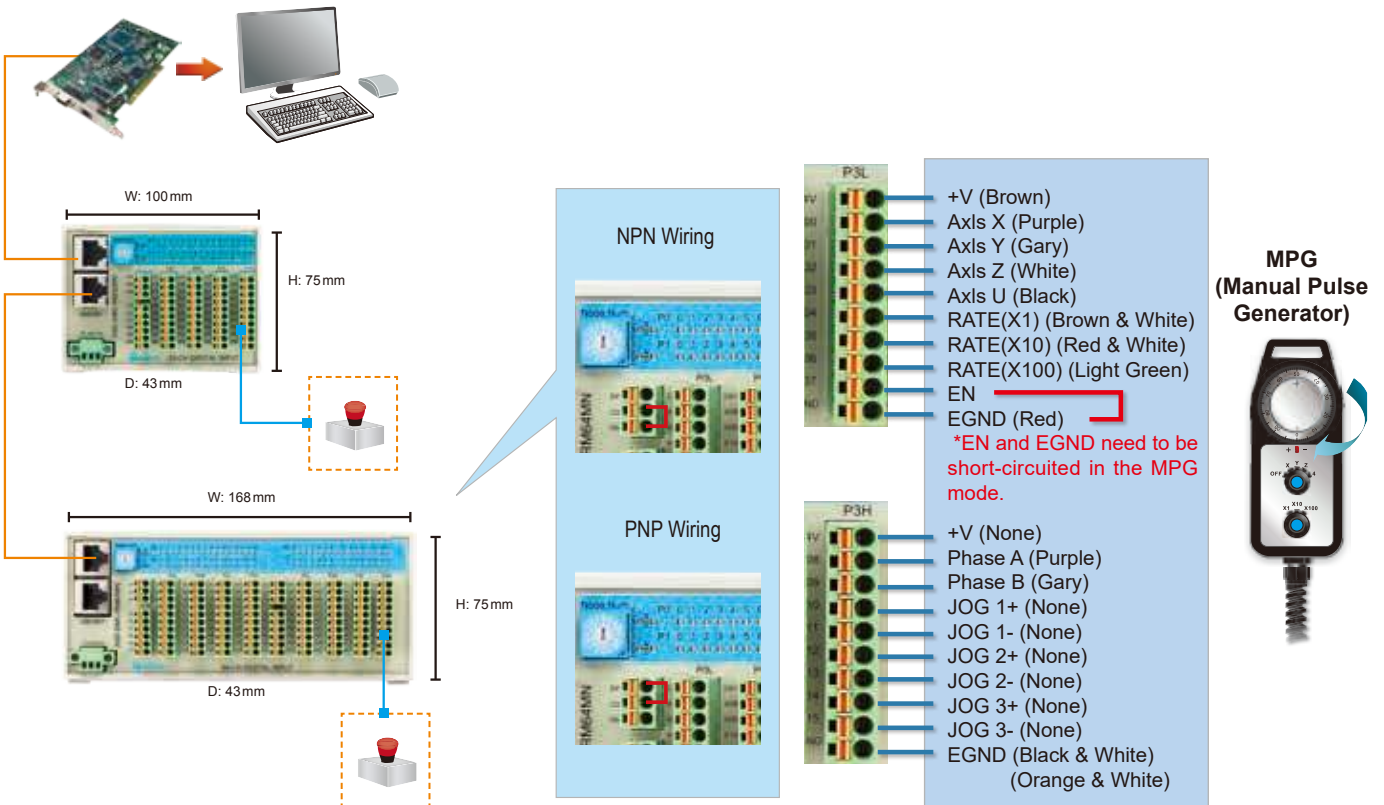

\*MPG can only be used for the terminals of P3H and P3L of ASD-DMC-RM64MN.

## Digital Output Remote Modules

- ASD-DMC-RM32NT (32 DO)
- ASD-DMC-RM64NT (64 DO)
- ASD-DMC-RM32PT (16 DI/16 DO)
  - Non-volatile memories can be managed through a software API
  - Load Output: 0.1A/1 Point

## Electrical Specifications

Model Name	RM32NT/RM64NT
Output Circuit Type	Transistor
Output Signal Type	SINK
Current Specifications	0.1A/1 point
Voltage Specifications	24 V <sub>DC</sub>
Maximum Switching (Operating) Frequency	1 kHz
Action Level (OFF > ON)	20 μs
Action Level (ON > OFF)	30 μs
Noise Tolerance Threshold	ESD (IEC 61131-2, IEC 61000-4-2): 8 KV Air Discharge EFT (IEC 61131-2, IEC 61000-4-4): Power Line: 2KV, Communication I/O: 1KV RS (IEC 61131-2, IEC 61000-4-3): 80 MHz ~ 1 GHz, 10V/m
Environment	Operating Temperature: 0°C ~ 50°C Storage Temperature: -20°C ~ 70°C

## Installation & Wiring

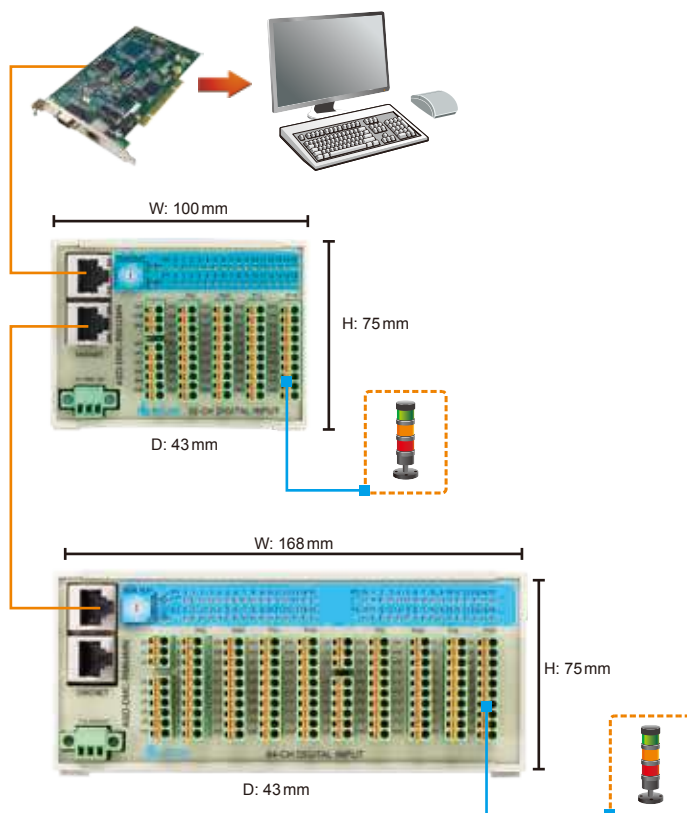

# DMCNET Remote Modules

## ● HMC-RIO3232RT5 (Digital I/O Remote Module)

- 16 points relay type output unit, Max. loading: 2A/ 1 Point with non-volatile memory function
- 16 points transistor type output unit, Max. loading: 0.1A/ 1 Point
- 32 points digital input unit – supports SINK and SOURCE modes

## Electrical Specifications

Item	HMC-RIO3232RT5
Supply Voltage	24 V <sub>DC</sub> (15% ~ 20%)
Power Consumption	1.2W
Noise Immunity	RS: Frequency: 80 MHz ~ 1 GHz, 1.4 GHz ~ 2.0 GHz, Test level 10V/m ESD: Contact discharge ±8KV Air discharge ±8KV EFT: ±2KV (Power port), ±2KV (I/O line), Surge: ±2KV (RIO power port)
Temperature	Operating: 0°C ~ 55°C (Temperature), 10 ~ 90% (Humidity); Storage: -20°C ~ 60°C (Temperature), 10 ~ 90% (Humidity)
Vibration	IEC 61131-2 compliant 5 Hz ~ 8.3 Hz = Continuous: 3.5 mm, 8.3 Hz ~ 150 Hz = Continuous: 1.0 g
Shock	IEC 60068-2-27 compliant 15 g peak for 11 ms duration X, Y, Z directions for 6 times
Weight	Approx. 460g

Item	Input Port	Item	Output Port
Input Signal Type	SINK/SOURCE	Output Circuit Type	Transistor/Relay
Input Signal Voltage	24 V <sub>DC</sub> (5 mA)	Voltage Specifications	24 V <sub>DC</sub> (-10% ~ +15%) / < 250 V <sub>AC</sub> (Relay Only)
Input Impedance	4.7K ohm	Current Specifications	100 mA/1 Point (Transistor), 2A/1 Point (Relay), Resistive Load
Action Level	(OFF → ON) > 16.5 V <sub>DC</sub> (ON → OFF) < 5 V <sub>DC</sub>	Max. Switching (Operating) Frequency	8 kHz (TR) / 1 Hz (RELAY)
		Response Time	TR: (ON → OFF) : 115 μs, (OFF → ON) : 12 μs RELAY: (ON → OFF) : 10 ms, (OFF → ON) : 10 ms

## Installation & Wiring

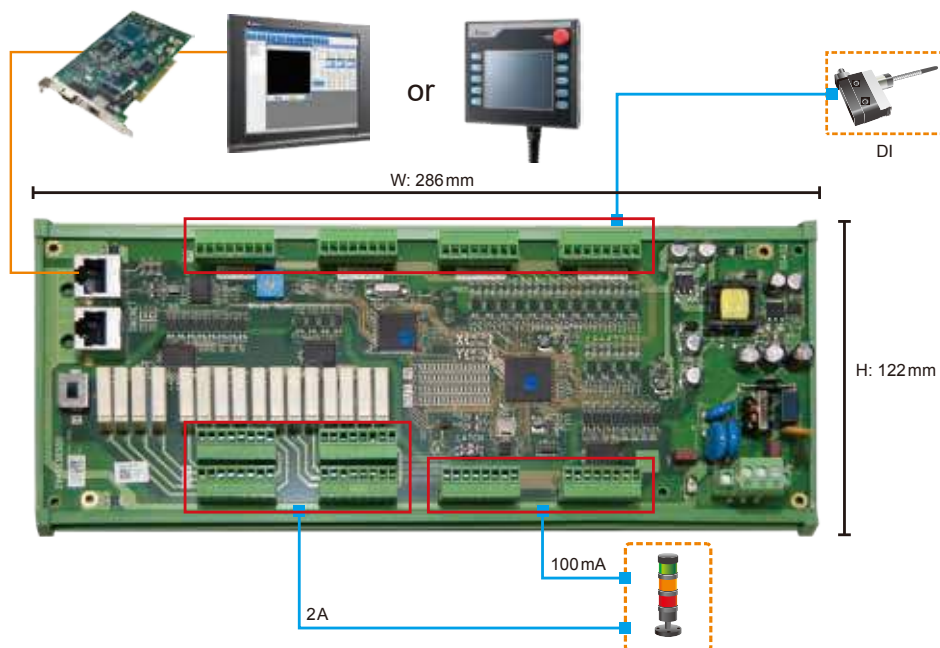

# DMCNET Remote Modules

## ASD-DMC-RM04PI (4-Channel Pulse)

- 4 channels of 200 kHz pulse outputs (Pulse +Direction, CCW pulse +CW pulse, A phase + B phase)
- 4 channels of 200 kHz pulse inputs (CCW pulse +CW pulse, A phase + B phase)
- Digital Inputs x8/Digital Outputs x8
- Built-in Positive/Negative Limit and Home for each channel
- In Mode 1, each RM04PI module occupies one node number only, and interpolation motion is carried out within one module.\*
  - 4 channels occupy 1 node number only
  - 4 channels occupy one PDO and SDO
  - Performs interpolation motion of 4 channels within one RM04PI module only
  - Transfers data in cyclical patterns
  - Motion commands set by parameters
  - Point-to-Point motion mode, motion position calculation is performed within one RM04PI module

Note: For real-time requirements such as data update, this mode would be inappropriate because four channels share one node only.

- In Mode 2, each RM04PI module occupies node numbers 1~4, which correspond to 4 channels. The interpolation motion can be carried out among different modules.

## Electrical Specifications

ASD-DMC-RM04PI	
Item	Input (QA, QB, QZ, DI1, DI2)
Circuit Type	Single
Signal Type	SINK
Power Supply Voltage	5V <sub>DC</sub>
Work Frequency	QA, QB, QZ: 200 kHz (5mA/1 point) DI1, DI2: 1 kHz (5mA/1 point)
Noise Immunity	ESD (IEC 61131-2, IEC 61000-4-2): 8 KV Air Discharge EFT (IEC 61131-2, IEC 61000-4-4): Power Line: 2KV Communication I/O: 1KV RS (IEC 61131-2, IEC 61000-4-3): 80MHz ~ 1 GHz, 10V/m
Operating/Storage Environment	Operating: 0°C ~ 50°C (32°F ~ 122°F) Storage: -20°C ~ 70°C (-4°F ~ 158°F)

ASD-DMC-RM04PI		
Item	Input (MEL, PEL, ORG, SLD)	Output (CW, CCW, DO1, DO2)
Circuit Type	Single	Transistor
Signal Type	SINK / SOURCE	SINK
Power Supply Voltage	24V <sub>DC</sub> (5mA)	5~24V <sub>DC</sub> (30mA / 1 point)
Response Time/Work Frequency	1 ms	CW, CCW: 200 kHz DO1, DO2: 1 kHz
Active Level (OFF > ON)	> 16.5V <sub>DC</sub>	-
Active Level (ON > OFF)	< 8V <sub>DC</sub>	-
Noise Immunity	ESD (IEC 61131-2, IEC 61000-4-2): 8 KV Air Discharge EFT (IEC 61131-2, IEC 61000-4-4): - Power Line: 2KV - Communication I/O: 1KV RS (IEC 61131-2, IEC 61000-4-3): 80MHz ~ 1 GHz, 10V/m	
Operating/Storage Environment	Operating: 0°C ~ 50°C (32°F ~ 122°F) Storage: -20°C ~ 70°C (-4°F ~ 158°F)	

## Installation & Wiring

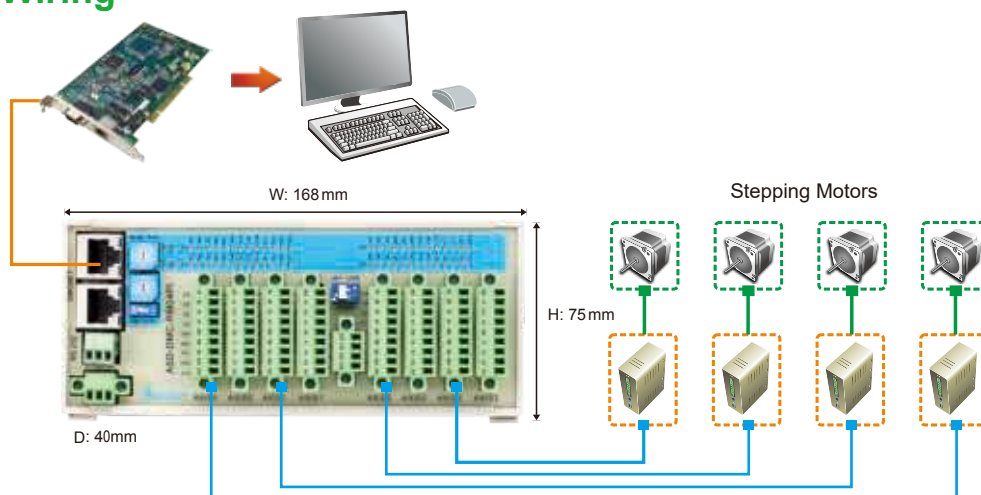

● **ASD-DMC-RM04AD (4-Channel Analog Input)**

**Electrical Specifications**

<b>ASD-DMC-RM04AD</b>	
Channel	4 Channels/module
Voltage Analog Input Range	-10 ~ 10V/-5 ~ 5V / 0 ~ 10V/0 ~ 5V
Current Analog Input Range	0 ~ 24mA
Digital Conversion Range	0 ~ 65,535
Resolution	16bits
Voltage Input Resistance	140kΩ
Current Input Resistance	249Ω
General Precision	Within ±0.5% (25°C, 77°F) at full scale Within ±1% (0 ~ 55°C, 32 ~ 131°F) at full scale
Response Time	Min. 1 ms/Max. 3 ms × the number of channels.
Isolation	Internal circuit and analog output terminals are isolated with an optical coupler
Voltage Absolute Input Range	-15 ~ 15
Current Absolute Input Range	32mA
Digital Data Format	16 significant bits
Sampling Mode	Five modes which the average number is two (2), four (4), eight (8), sixteen (16) and thirty-two (32) are available for selection.

**Installation & Wiring**

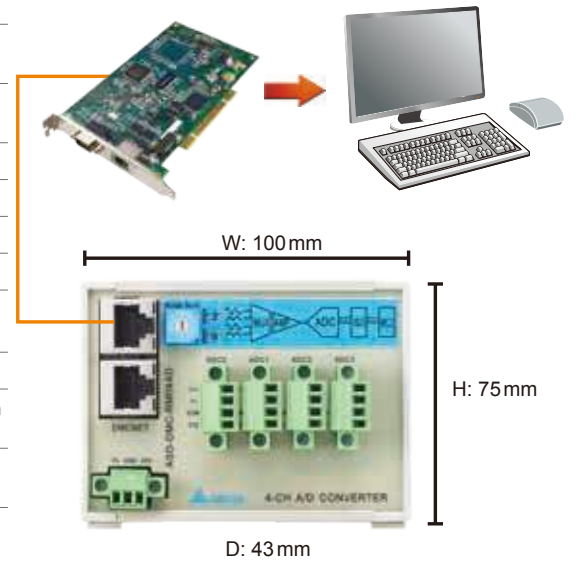

● **ASD-DMC-RM04DA (4-Channel Analog Output)**

**Electrical Specifications**

<b>ASD-DMC-RM04DA</b>	
Channel	4 Channels/module
Voltage Output Range	-10 ~ 10V/-5 ~ 5V/0 ~ 10V/0 ~ 5V
Current Output Range	0 ~ 24mA/0 ~ 20mA/4 ~ 20mA
Excess Limit (Voltage)	10%
Maximum Output Current (Voltage)	20mA
Allowable Load Resistance (Current)	0 ~ 500Ω
Digital Data Range	0 ~ 4,096
Resolution	16bits
DC Output Resistance	0.3Ω
Response Time	1 ms
Digital Data Format	16 bits
Isolation	Internal circuit and analog output terminals are isolated with an optical coupler
Protection	Voltage output is protected by short circuit, but must be aware of long-lasting short circuit damaging the internal circuits

**Installation & Wiring**

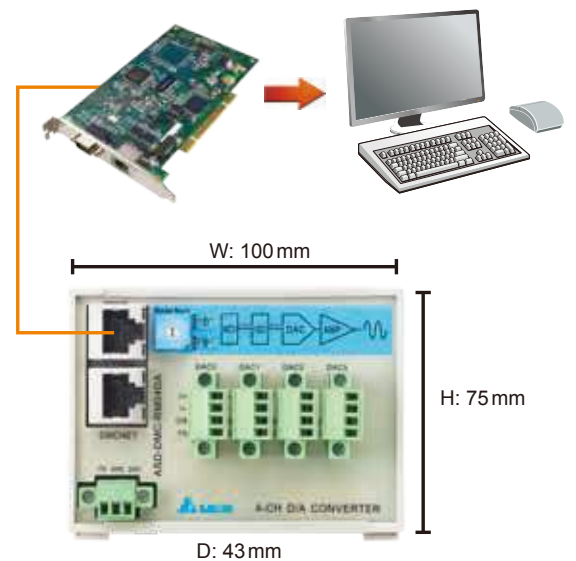



# Gateway Type Remote Power Coupler

## • Master Module - GA Series



- One GA01 can connect up to a maximum of 4 GE remote modules, of which there may be a maximum of four GE01PH modules.
- One GE01PH module occupies one node number.
- The EzDMC provides a software auto calculation function for calculating the numbers of start and end stations of the ASD-DMC-GA01.

## ASD-DMC-GA01 Switching Settings



ADDR1		
PIN	Function	Explanation
1 ~ 12	Start Node Address	Start Station

  

ADDR2		
PIN	Function	Explanation
1 ~ 12	End Node Address	End Station

There is no communication when the value is set to 0 and 13 ~ 15.  
 When ADDR1 is set to 1 and ADDR2 is set to 2, it indicates that the remote modules have occupied two stations.

# Gateway Type Digital I / O Remote Module

## • Slave Module - GE Series

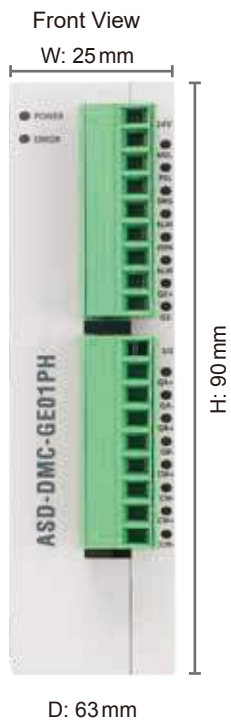

## Gateway Type 1-Channel Pulse Remote Module ASD-DMC-GE01PH

### Electrical Specifications

ASD-DMC-GE01PH		
Item	Input	Output
Circuit Type	Single common port input	Transistor
Signal Type	SINK/SOURCE	SINK
Signal Voltage	24 V <sub>DC</sub> (5 mA)	5 ~ 24 V <sub>DC</sub> (30 mA/1 point)
Response Time	1 ms	
Maximum Input Pulse Frequency	QA+, QB+, QZ+, QA-, QB-, QZ-: 4 MHz (5 mA/1 point)	CW, CCW: 4 MHz (30 mA/1 point) A, B Phase: 4 MHz (30 mA/1 point) SVON, RALM: 1 kHz (30 mA/1 point)
Action Level (OFF → ON)	> 16.5 V <sub>DC</sub>	-
Trigger Level (ON → OFF)	< 8 V <sub>DC</sub>	-
Output Circuit Type	-	RS-422
Output Signal Type	-	Differential

# Ordering Information

## Programmable Automation Controllers - Motion Control Host PAC

Model Name	CPU Type	Storage	Slot Interface	RAM	OS	Motion Protocol	Development Tool
MH2-P10N-N04DL	Celeron J1900 Quad Core 2.0GHz	NA	64 GB SSD	4 GB	Win 10 IoT 64 bit	EtherCAT	API

## Programmable Automation Controllers - Motion Control Panel PC

Model Name	CPU Type	Storage	Slot Interface	RAM	OS	Motion Protocol	Development Tool
MP1-P10D-150ADL	Celeron J1900 Quad Core 2.0GHz	15"	64 GB CFast	4 GB	Win 10 IoT 64 bit	DMCNET	API/IMP
MP1-P10D-150BDL			128 GB CFast				

## Motion Control Cards

PCIE-L221-B1D0	32-axis Standard EtherCAT Motion Control Card + 2 Sets of Pulse Comparison
PCIE-L221-BF1D0	16-axis Standard EtherCAT Motion Control Card + 2 Sets of Pulse Comparison
PCIE-L221-BF0D0	8-axis Standard EtherCAT Motion Control Card + 2 Sets of Pulse Comparison
PCI-L221-P1D0	32-axis Basic EtherCAT Motion Control Card
PCI-L221-F1D0	16-axis Basic EtherCAT Motion Control Card
PCI-L221-F0D0	8-axis Basic EtherCAT Motion Control Card
PCI-L221-B1D0	32-axis Standard EtherCAT Motion Control Card + 2 Sets of Pulse Comparison
PCI-L221-BF1D0	16-axis Standard EtherCAT Motion Control Card + 2 Sets of Pulse Comparison
PCI-L221-BF0D0	8-axis Standard EtherCAT Motion Control Card + 2 Sets of Pulse Comparison
PCI-L221-CF1D0	16-axis Standard EtherCAT Motion Control Card + MPG
PCI-L221-CF0D0	8-axis Standard EtherCAT Motion Control Card + MPG
PCI-DMC-A02	DMCNET Standard Type Motion Control Card with Local I/O (32 DI/24 DO)
PCI-DMC-B01	DMCNET Advanced Type Motion Control Card with 2 Groups of Pulse Compare
PCI-DMC-B02	DMCNET Advanced Motion Control Card + 2D Pulse Compare
PCI-DMC-B03	DMCNET Advanced Motion Control Card + 3 Sets of Pulse Compare & 10 Sets of DO
PCI-DMC-F02	DMCNET Economic Type Motion Control Card + local I/O (32 DI/24 DO)

## Ordering Information

EtherCAT Remote Modules	
R1-EC5500D0	E-BUS Remote Power Coupler
R1-EC5621D0	1-Channel Pulse Output Remote Module
R1-EC5614D0	MPG Extension Module
R1-EC6002D0	Digital Input Remote Module (NPN/PNP); response time < 0.1 ms
R1-EC6022D0	Input Remote Module (NPN/PNP); response time 2ms
R1-EC7062D0	Digital Output Remote Module (NPN)
R1-EC70A2D0	Digital Output Remote Module (PNP)
R1-EC70E2D0	Digital Output Remote Module (NPN)
R1-EC70F2D0	Digital Output Remote Module (PNP)
R1-EC8124D0	4-Channel Analog Input Module
R1-EC9144D0	4-Channel Analog Output Module

EtherCAT Remote Module	
R2-EC0902D0	Digital Input/Output Remote Module with Relay

DMCNET Remote Modules	
ASD-DMC-RM32MN	32 Digital Input Remote Module (NPN/PNP)
ASD-DMC-RM64MN	64 Digital Input Remote Module (NPN/PNP) plus MPG Module
ASD-DMC-RM32NT	32 Digital Output Remote Module
ASD-DMC-RM64NT	64 Digital Output Remote Module
ASD-DMC-RM32PT	32 Digital I/O Remote Module with 16 DI (NPN/PNP) & 16 DO (Transistor Output)
ASD-DMC-RM04PI	4-Channel Pulse Remote Module (4 Channels of 200 kHz Pulse Outputs and Inputs)
ASD-DMC-RM04AD	4-Channel Analog Input Module
ASD-DMC-RM04DA	4-Channel Analog Output Module
HMC-RIO3232RT5	Digital I/O Remote Module with 32 DI (NPN/PNP), 16 DO (Relay Output) & 16 DO (Transistor Output)

DMCNET Gateway Type Remote Modules	
ASD-DMC-GA01	DMCNET Gateway Type Remote Power Coupler
ASD-DMC-GE01PH	DMCNET Gateway Type Pulse Output Remote Module (1-Channel of 4M High-speed Pulse Interface)

# Global Operations

## ASIA (Taiwan)



Taoyuan Technology Center (Green Building)



Taoyuan Plant 1



Tainan Plant (Diamond-rated Green Building)



Wujiang Plant 3



Shanghai Office

## ASIA (China)

## ▲ 8 Factor

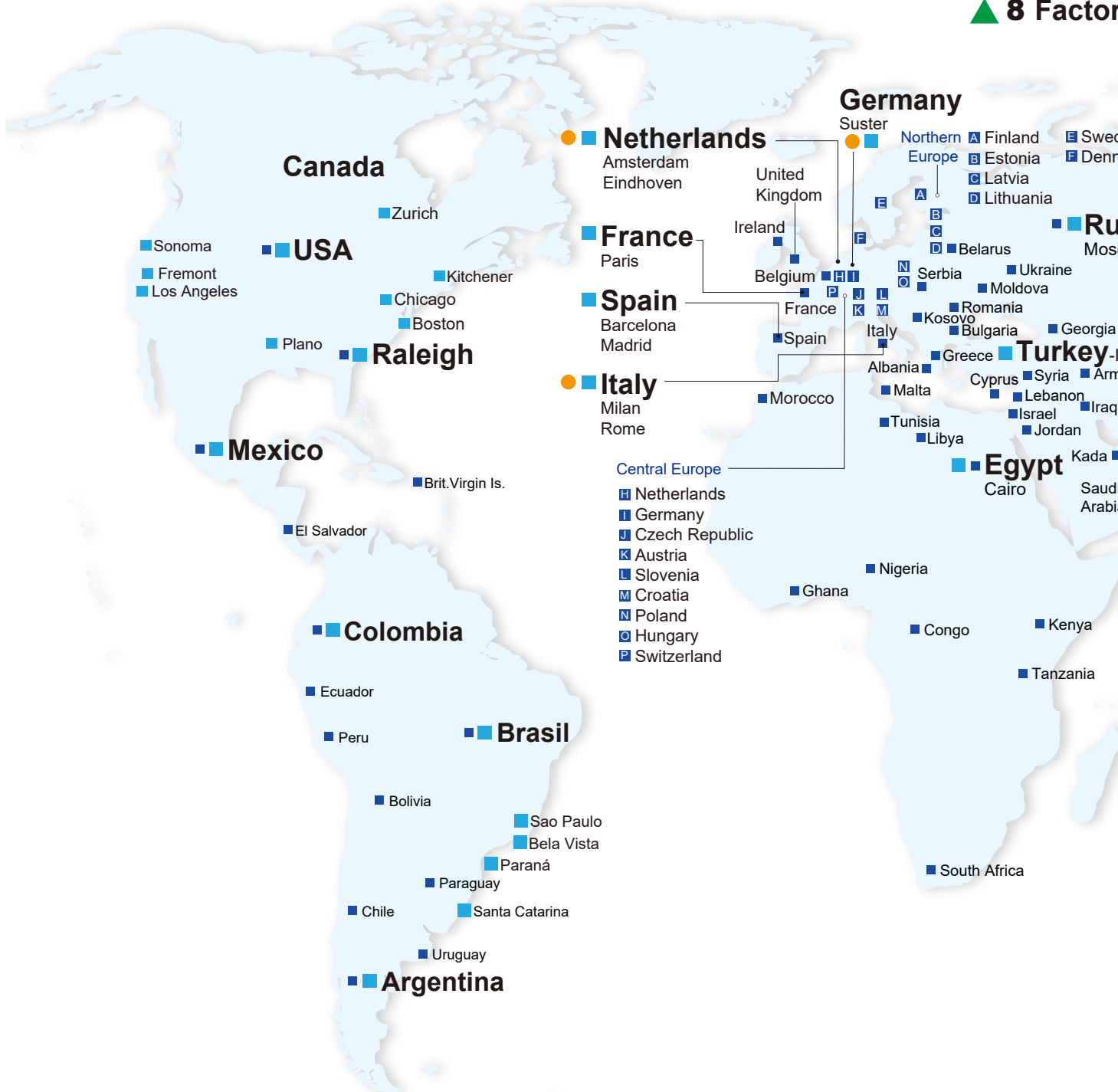

**ASIA (Japan)**



Tokyo Office

**ASIA (India)**



Rudrapur Plant (Green Building)

**EUROPE**



Amsterdam, the Netherlands

**AMERICA**



Research Triangle Park, U.S.A.

**112 Branch Offices**

**13 R&D Centers**

**909 Distributors**

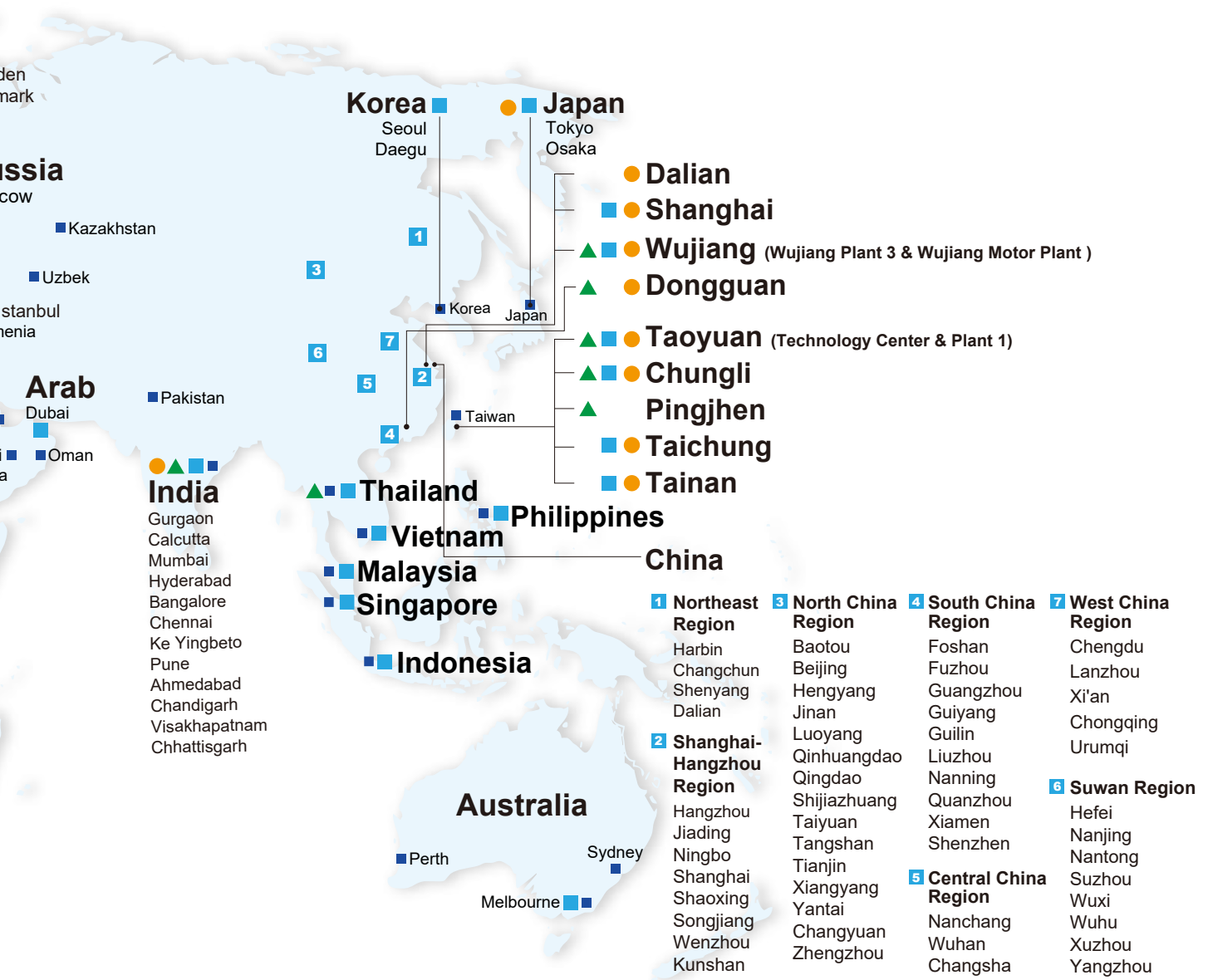





Smarter. Greener. Together.

## Industrial Automation Headquarters

### Taiwan: Delta Electronics, Inc.

Taoyuan Technology Center  
No.18, Xinglong Rd., Taoyuan District,  
Taoyuan City 33068, Taiwan  
TEL: +886-3-362-6301 / FAX: +886-3-371-6301

## Asia

### China: Delta Electronics (Shanghai) Co., Ltd.

No.182 Minyu Rd., Pudong Shanghai, P.R.C.  
Post code : 201209  
TEL: +86-21-6872-3988 / FAX: +86-21-6872-3996  
Customer Service: 400-820-9595

### Japan: Delta Electronics (Japan), Inc.

Industrial Automation Sales Department  
2-1-14 Shibadaimon, Minato-ku  
Tokyo, Japan 105-0012  
TEL: +81-3-5733-1155 / FAX: +81-3-5733-1255

### Korea: Delta Electronics (Korea), Inc.

1511, 219, Gasan Digital 1-Ro., Geumcheon-gu,  
Seoul, 08501 South Korea  
TEL: +82-2-515-5305 / FAX: +82-2-515-5302

### Singapore: Delta Energy Systems (Singapore) Pte Ltd.

4 Kaki Bukit Avenue 1, #05-04, Singapore 417939  
TEL: +65-6747-5155 / FAX: +65-6744-9228

### India: Delta Electronics (India) Pvt. Ltd.

Plot No.43, Sector 35, HSIIDC Gurgaon,  
PIN 122001, Haryana, India  
TEL: +91-124-4874900 / FAX: +91-124-4874945

### Thailand: Delta Electronics (Thailand) PCL.

909 Soi 9, Moo 4, Bangpoo Industrial Estate (E.P.Z),  
Pattana 1 Rd., T.Phraksa, A.Muang,  
Samutprakarn 10280, Thailand  
TEL: +66-2709-2800 / FAX: +66-2709-2827

### Australia: Delta Electronics (Australia) Pty Ltd.

Unit 20-21/45 Normanby Rd., Notting Hill Vic 3168, Australia  
TEL: +61-3-9543-3720

## Americas

### USA: Delta Electronics (Americas) Ltd.

5101 Davis Drive, Research Triangle Park, NC 27709, U.S.A.  
TEL: +1-919-767-3813 / FAX: +1-919-767-3969

### Brazil: Delta Electronics Brazil

Rua Itapeva, 26 - 3º, andar Edifício Itapeva,  
One - Bela Vista 01332-000 - São Paulo - SP - Brazil  
TEL: +55-12-3932-2300 / FAX: +55-12-3932-237

### Mexico: Delta Electronics International Mexico S.A. de C.V.

Gustavo Baz No. 309 Edificio E PB 103  
Colonia La Loma, CP 54060  
Tlalneantla, Estado de México  
TEL: +52-55-3603-9200

## EMEA

### EMEA Headquarters: Delta Electronics (Netherlands) B.V.

Sales: Sales.IA.EMEA@deltaww.com  
Marketing: Marketing.IA.EMEA@deltaww.com  
Technical Support: iatechnicalsupport@deltaww.com  
Customer Support: Customer-Support@deltaww.com  
Service: Service.IA.emea@deltaww.com  
TEL: +31(0)40 800 3900

### BENELUX: Delta Electronics (Netherlands) B.V.

Automotive Campus 260, 5708 JZ Helmond, The Netherlands  
Mail: Sales.IA.Benelux@deltaww.com  
TEL: +31(0)40 800 3900

### DACH: Delta Electronics (Netherlands) B.V.

Coesterweg 45, D-59494 Soest, Germany  
Mail: Sales.IA.DACH@deltaww.com  
TEL: +49(0)2921 987 0

### France: Delta Electronics (France) S.A.

ZI du bois Challand 2, 15 rue des Pyrénées,  
Lisses, 91090 Evry Cedex, France  
Mail: Sales.IA.FR@deltaww.com  
TEL: +33(0)1 69 77 82 60

### Iberia: Delta Electronics Solutions (Spain) S.L.U

Ctra. De Villaverde a Vallecas, 265 1º Dcha Ed.  
Hormigueras – P.I. de Vallecas 28031 Madrid  
TEL: +34(0)91 223 74 20

Carrer Llacuna 166, 08018 Barcelona, Spain

Mail: Sales.IA.Iberia@deltaww.com

### Italy: Delta Electronics (Italy) S.r.l.

Via Meda 2-22060 Novedrate(CO)  
Piazza Grazioli 18 00186 Roma Italy  
Mail: Sales.IA.Italy@deltaww.com  
TEL: +39 039 8900365

### Russia: Delta Energy System LLC

Vereyskaya Plaza II, office 112 Vereyskaya str.  
17 121357 Moscow Russia  
Mail: Sales.IA.RU@deltaww.com  
TEL: +7 495 644 3240

### Turkey: Delta Greentech Elektronik San. Ltd. Sti. (Turkey)

Şerifali Mah. Hendem Cad. Kule Sok. No:16-A  
34775 Ümraniye – İstanbul  
Mail: Sales.IA.Turkey@deltaww.com  
TEL: + 90 216 499 9910

### MEA: Eltek Dubai (Eltek MEA DMCC)

OFFICE 2504, 25th Floor, Saba Tower 1,  
Jumeirah Lakes Towers, Dubai, UAE  
Mail: Sales.IA.MEA@deltaww.com  
TEL: +971(0)4 2690148