

# SSP1D440BDT

Harmony, Solid state relay, 40 A, panel mount, DC switching, thermal pad, input 3.5...32 V DC, output 1...150 V DC



## Main

Range of Product	Harmony Solid State Relays
Product or Component Type	Solid state relay up to 40 A
Provided accessory	Thermal pad
Device short name	SSP1
Mounting Support	Panel
Number of phases	1 phase
Line Rated Current	40 A
Solid state output type	Mosfet output DC switching
Output switching mode	DC switching

## Complementary

[Uc] control circuit voltage	3.5...32 V DC
Minimum switching voltage	3.5 V DC turn-on
Maximum switching voltage	1 V DC turn-off
Response time	0.1 ms (turn-on) 0.1 ms (turn-off)
Input current	10...15 mA
Output voltage	1...150 V DC
Load current	0.001...40 A
Surge current	106 A 10 ms
Co-ordination type	Type 2 - 20 A miniature circuit breaker (MCB) B Type 1 - 40 A miniature circuit breaker (MCB) B
Maximum leakage current	0.3 mA off-state
Maximum voltage drop	<2.1 V on-state
Insulation resistance	1000 MOhm at 500 V DC
Maximum capacitance	50 pF for input/output
Dielectric strength	2.5 kV AC for input/output 2.5 kV AC for input or output to case
[Uimp] rated impulse withstand voltage	2.5 kV output to case
Tightening torque	1.5...1.7 N.m for input 2...2.2 N.m for output
Connections - terminals	Screw terminals 0.2...3.3 mm <sup>2</sup> , AWG 24...AWG 12) with cable end input Screw terminals 0.5...5.26 mm <sup>2</sup> , AWG 20...AWG 10) with cable end output Screw terminals 0.2...3.3 mm <sup>2</sup> , AWG 24...AWG 12) without cable end input Screw terminals 0.5...8.26 mm <sup>2</sup> , AWG 20...AWG 8) without cable end output Forked type tag connectors 9.2 x 4 mm input Ring lugs 9.2 x 4 mm input Forked type tag connectors 11.7 x 4.5 mm output Ring lugs 11.7 x 4.5 mm output
Thermal resistance	0.22 °C/W junction to case
Thermal pad impedance	0.48 °C-in <sup>2</sup> /W at 25 psi
LED indicator	LED, green input
IP degree of protection	IP20
Safety reliability data	B10d = 1731395 MTTFd = 1875.9 years
Net Weight	3.15 oz (89.2 g)
Device presentation	Complete product

## Environment

Ambient air temperature for operation	-40...176 °F (-40...80 °C)
Ambient Air Temperature for Storage	-40...257 °F (-40...125 °C)
Pollution degree	2
Overvoltage category	III
Product Certifications	UL CE CSA EAC
Marking	EAC CSA UL CE
Standards	CSA C22.2 No 14-13 UL 508 EN/IEC 62314 EN/IEC 60950-1







## Ordering and shipping details

Category	22375 - INTERFACE MODULE(ABA,R,S)
Discount Schedule	CP2
GTIN	3606485442020
Nbr. of units in pkg.	1
Package weight(Lbs)	3.67 oz (104 g)
Returnability	Yes
Country of origin	MX

## Packing Units

Unit Type of Package 1	PCE
Package 1 Height	1.50 in (3.8 cm)
Package 1 width	1.89 in (4.8 cm)
Package 1 Length	2.56 in (6.5 cm)
Unit Type of Package 2	S01
Number of Units in Package 2	30
Package 2 Weight	7.82 lb(US) (3.546 kg)
Package 2 Height	5.91 in (15 cm)
Package 2 width	5.91 in (15 cm)
Package 2 Length	15.75 in (40 cm)

## Offer Sustainability

Sustainable offer status	Green Premium product
California proposition 65	WARNING: This product can expose you to chemicals including: Lead and lead compounds, which is known to the State of California to cause cancer and birth defects or other reproductive harm. For more information go to <a href="http://www.P65Warnings.ca.gov">www.P65Warnings.ca.gov</a>
REACH Regulation	 <a href="#">REACH Declaration</a>
REACH free of SVHC	Yes
EU RoHS Directive	Pro-active compliance (Product out of EU RoHS legal scope)  <a href="#">EU RoHS Declaration</a>
Toxic heavy metal free	Yes
Mercury free	Yes
RoHS exemption information	 <a href="#">Yes</a>
China RoHS Regulation	 <a href="#">China RoHS Declaration</a>
Environmental Disclosure	 <a href="#">Product Environmental Profile</a>
Circularity Profile	 <a href="#">End Of Life Information</a>

Dimensions

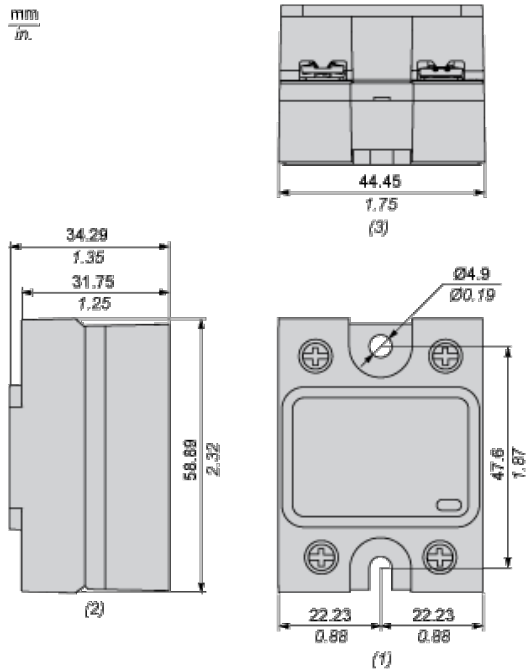

- (1) Front view
- (2) Side view
- (3) Bottom view

Derating Curves

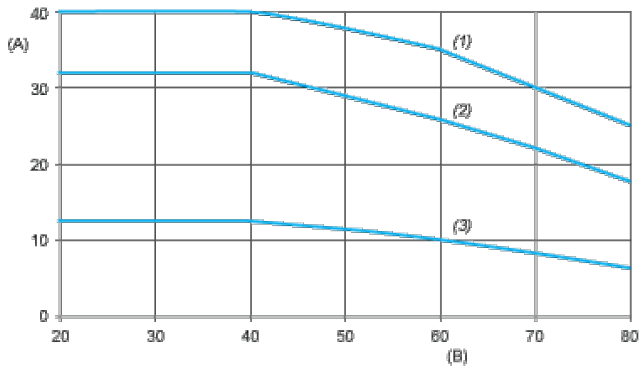

- A : Load Current (Arms)
- B : Ambient Temperature (°C)
- (1) For Heatsink SSRHD10
- (2) For Heatsink SSRHP17
- (3) No Heatsink