

IRGS4056DPbF

INSULATED GATE BIPOLAR TRANSISTOR WITH ULTRAFAST SOFT RECOVERY DIODE

Features

- Low $V_{CE(ON)}$ Trench IGBT Technology
- Low switching losses
- Maximum Junction temperature 175 °C
- 5 μ S short circuit SOA
- Square RBSOA
- 100% of the parts tested for 4X rated current (I_{LM})
- Positive $V_{CE(ON)}$ Temperature co-efficient
- Ultra fast soft Recovery Co-Pak Diode
- Tight parameter distribution
- Lead Free Package

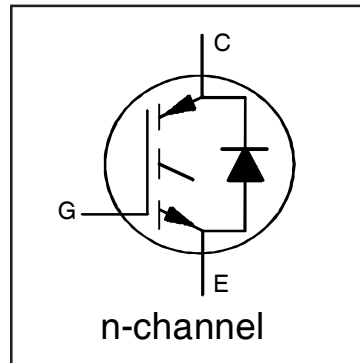

$V_{CES} = 600V$
$I_C = 12A, T_C = 100^\circ C$
$t_{SC} \geq 5\mu s, T_{J(max)} = 175^\circ C$
$V_{CE(on)} \text{ typ.} = 1.55V$

Benefits

- High Efficiency in a wide range of applications
- Suitable for a wide range of switching frequencies due to Low $V_{CE(ON)}$ and Low Switching losses
- Rugged transient Performance for increased reliability
- Excellent Current sharing in parallel operation
- Low EMI

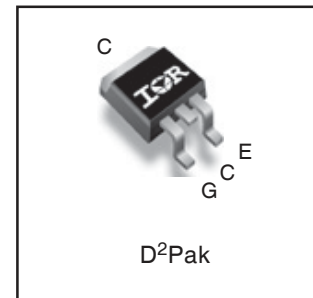

G	C	E
Gate	Collector	Emitter

Absolute Maximum Ratings

	Parameter	Max.	Units
V_{CES}	Collector-to-Emitter Voltage	600	V
$I_C @ T_C = 25^\circ C$	Continuous Collector Current	24	A
$I_C @ T_C = 100^\circ C$	Continuous Collector Current	12	
I_{CM}	Pulse Collector Current	48	
I_{LM}	Clamped Inductive Load Current ①	48	
$I_F @ T_C = 25^\circ C$	Diode Continuous Forward Current	24	
$I_F @ T_C = 100^\circ C$	Diode Continuous Forward Current	12	
I_{FM}	Diode Maximum Forward Current ②	48	
V_{GE}	Continuous Gate-to-Emitter Voltage	± 20	
	Transient Gate-to-Emitter Voltage	± 30	
$P_D @ T_C = 25^\circ C$	Maximum Power Dissipation	140	W
$P_D @ T_C = 100^\circ C$	Maximum Power Dissipation	70	
T_J	Operating Junction and	-55 to +175	°C
T_{STG}	Storage Temperature Range		
	Soldering Temperature, for 10 sec.	300 (0.063 in. (1.6mm) from case)	
	Mounting Torque, 6-32 or M3 Screw	10 lbf-in (1.1 N-m)	

Thermal Resistance

	Parameter	Min.	Typ.	Max.	Units
$R_{\theta JC}$ (IGBT)	Thermal Resistance Junction-to-Case-(each IGBT)	—	—	1.07	°C/W
$R_{\theta JC}$ (Diode)	Thermal Resistance Junction-to-Case-(each Diode)	—	—	3.66	
$R_{\theta CS}$	Thermal Resistance, Case-to-Sink (flat, greased surface)	—	0.50	—	
$R_{\theta JA}$	Thermal Resistance, Junction-to-Ambient (typical socket mount)	—	80	—	

Electrical Characteristics @ $T_J = 25^\circ\text{C}$ (unless otherwise specified)

	Parameter	Min.	Typ.	Max.	Units	Conditions	Ref.Fig
$V_{(BR)CES}$	Collector-to-Emitter Breakdown Voltage	600	—	—	V	$V_{GE} = 0V, I_C = 100\mu A$ ④	CT6
$\Delta V_{(BR)CES}/\Delta T_J$	Temperature Coeff. of Breakdown Voltage	—	0.30	—	V/ $^\circ\text{C}$	$V_{GE} = 0V, I_C = 1mA$ (25 $^\circ\text{C}$ -175 $^\circ\text{C}$)	CT6
$V_{CE(on)}$	Collector-to-Emitter Saturation Voltage	—	1.55	1.85	V	$I_C = 12A, V_{GE} = 15V, T_J = 25^\circ\text{C}$	5,6,7
		—	1.90	—		$I_C = 12A, V_{GE} = 15V, T_J = 150^\circ\text{C}$	9,10,11
		—	1.97	—		$I_C = 12A, V_{GE} = 15V, T_J = 175^\circ\text{C}$	
$V_{GE(th)}$	Gate Threshold Voltage	4.0	—	6.5	V	$V_{CE} = V_{GE}, I_C = 350\mu A$	9, 10,
$\Delta V_{GE(th)}/\Delta T_J$	Threshold Voltage temp. coefficient	—	-18	—	mV/ $^\circ\text{C}$	$V_{CE} = V_{GE}, I_C = 1.0mA$ (25 $^\circ\text{C}$ - 175 $^\circ\text{C}$)	11, 12
g_{fe}	Forward Transconductance	—	7.7	—	S	$V_{CE} = 50V, I_C = 12A, PW = 80\mu s$	
I_{CES}	Collector-to-Emitter Leakage Current	—	2.0	25	μA	$V_{GE} = 0V, V_{CE} = 600V$	
		—	475	—		$V_{GE} = 0V, V_{CE} = 600V, T_J = 175^\circ\text{C}$	
V_{FM}	Diode Forward Voltage Drop	—	2.10	3.10	V	$I_F = 12A$	8
		—	1.61	—		$I_F = 12A, T_J = 175^\circ\text{C}$	
I_{GES}	Gate-to-Emitter Leakage Current	—	—	± 100	nA	$V_{GE} = \pm 20V$	

Switching Characteristics @ $T_J = 25^\circ\text{C}$ (unless otherwise specified)

	Parameter	Min.	Typ.	Max.	Units	Conditions	Ref.Fig
Q_g	Total Gate Charge (turn-on)	—	25	38	nC	$I_C = 12A$	24
Q_{ge}	Gate-to-Emitter Charge (turn-on)	—	7.0	11		$V_{GE} = 15V$	CT1
Q_{gc}	Gate-to-Collector Charge (turn-on)	—	11	16		$V_{CC} = 400V$	
E_{on}	Turn-On Switching Loss	—	75	118	μJ	$I_C = 12A, V_{CC} = 400V, V_{GE} = 15V$	CT4
E_{off}	Turn-Off Switching Loss	—	225	273		$R_G = 22\Omega, L = 200\mu H, L_S = 150nH, T_J = 25^\circ\text{C}$	
E_{total}	Total Switching Loss	—	300	391		Energy losses include tail & diode reverse recovery	
$t_{d(on)}$	Turn-On delay time	—	31	40	ns	$I_C = 12A, V_{CC} = 400V, V_{GE} = 15V$	CT4
t_r	Rise time	—	17	24		$R_G = 22\Omega, L = 200\mu H, L_S = 150nH, T_J = 25^\circ\text{C}$	
$t_{d(off)}$	Turn-Off delay time	—	83	94			
t_f	Fall time	—	24	31			
E_{on}	Turn-On Switching Loss	—	185	—		μJ	$I_C = 12A, V_{CC} = 400V, V_{GE} = 15V$
E_{off}	Turn-Off Switching Loss	—	355	—	$R_G = 22\Omega, L = 100\mu H, L_S = 150nH, T_J = 175^\circ\text{C}$ ④		CT4
E_{total}	Total Switching Loss	—	540	—	Energy losses include tail & diode reverse recovery		WF1, WF2
$t_{d(on)}$	Turn-On delay time	—	30	—	ns	$I_C = 12A, V_{CC} = 400V, V_{GE} = 15V$	14, 16
t_r	Rise time	—	18	—		$R_G = 22\Omega, L = 200\mu H, L_S = 150nH$	CT4
$t_{d(off)}$	Turn-Off delay time	—	102	—		$T_J = 175^\circ\text{C}$	WF1
t_f	Fall time	—	41	—			WF2
C_{ies}	Input Capacitance	—	765	—		pF	$V_{GE} = 0V$
C_{oes}	Output Capacitance	—	52	—	$V_{CC} = 30V$		
C_{res}	Reverse Transfer Capacitance	—	23	—	$f = 1.0MHz$		
RBSOA	Reverse Bias Safe Operating Area	FULL SQUARE				$T_J = 175^\circ\text{C}, I_C = 48A$ $V_{CC} = 480V, V_p = 600V$ $R_G = 22\Omega, V_{GE} = +15V$ to 0V	4 CT2
SCSOA	Short Circuit Safe Operating Area	5	—	—	μs	$V_{CC} = 400V, V_p = 600V$ $R_G = 22\Omega, V_{GE} = +15V$ to 0V	22, CT3 WF4
E_{rec}	Reverse Recovery Energy of the Diode	—	280	—	μJ	$T_J = 175^\circ\text{C}$	17, 18, 19
t_{rr}	Diode Reverse Recovery Time	—	68	—	ns	$V_{CC} = 400V, I_F = 12A$	20, 21
I_{rr}	Peak Reverse Recovery Current	—	19	—	A	$V_{GE} = 15V, R_G = 22\Omega, L = 200\mu H, L_S = 150nH$	WF3

Notes:

- ① $V_{CC} = 80\% (V_{CES}), V_{GE} = 20V, L = 100\mu H, R_G = 22\Omega$.
- ② This is only applied to TO-220AB package.
- ③ Pulse width limited by max. junction temperature.
- ④ Refer to AN-1086 for guidelines for measuring $V_{(BR)CES}$ safely.

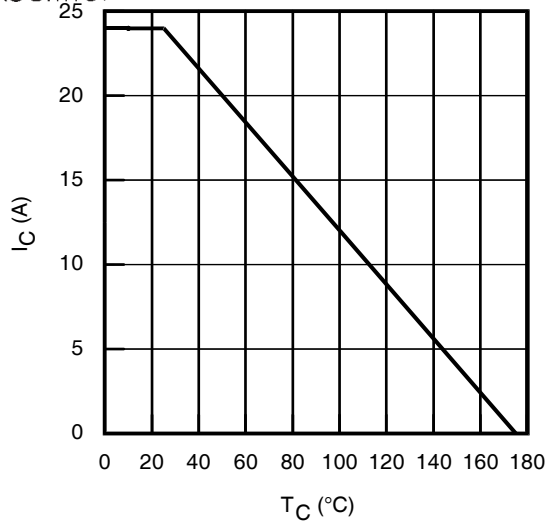

Fig. 1 - Maximum DC Collector Current vs. Case Temperature

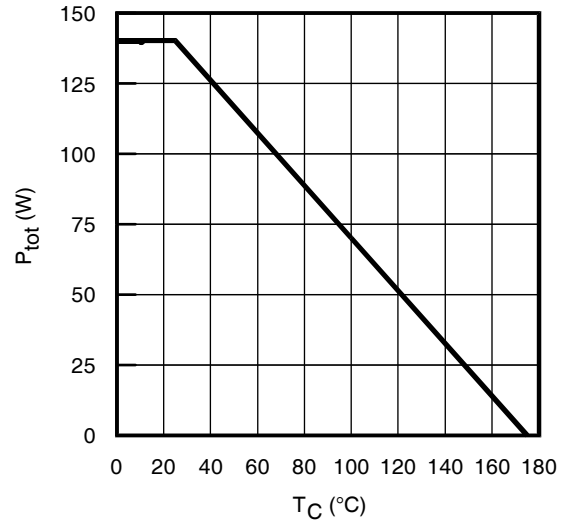

Fig. 2 - Power Dissipation vs. Case Temperature

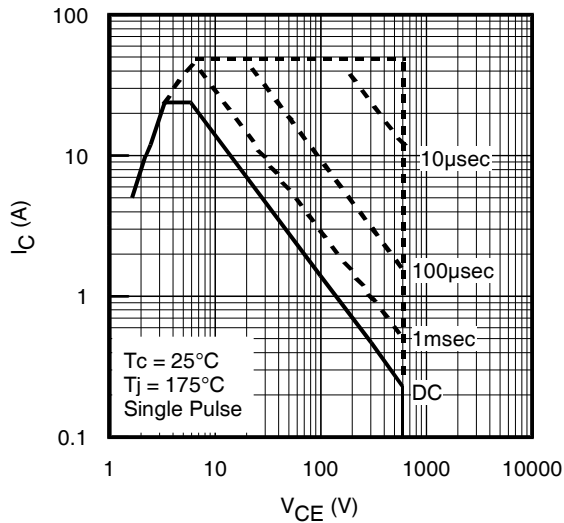

Fig. 3 - Forward SOA
 $T_C = 25^\circ\text{C}$, $T_J \leq 175^\circ\text{C}$; $V_{GE} = 15\text{V}$

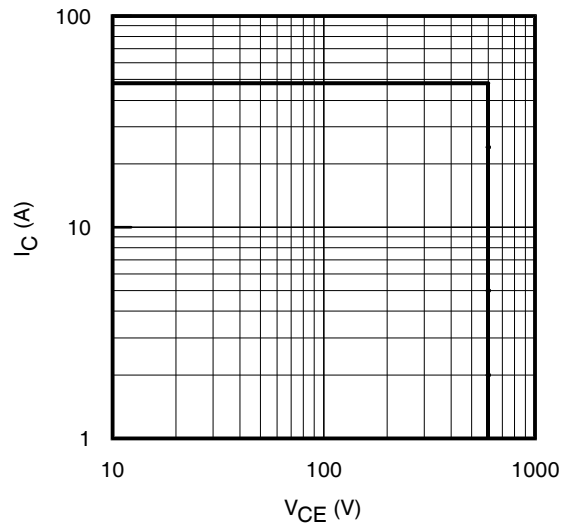

Fig. 4 - Reverse Bias SOA
 $T_J = 175^\circ\text{C}$; $V_{GE} = 15\text{V}$

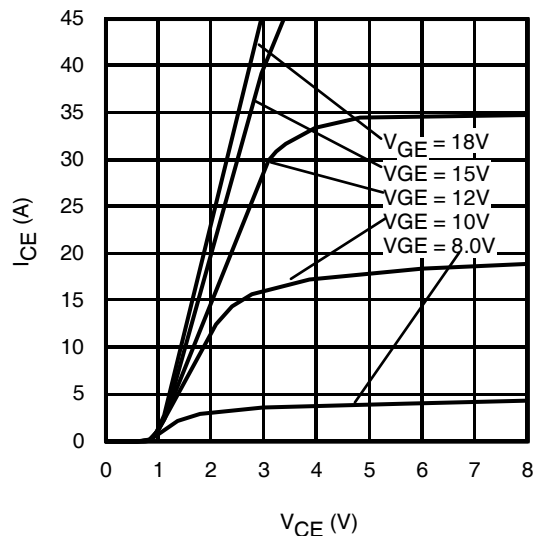

Fig. 5 - Typ. IGBT Output Characteristics
 $T_J = -40^\circ\text{C}$; $t_p = 80\mu\text{s}$

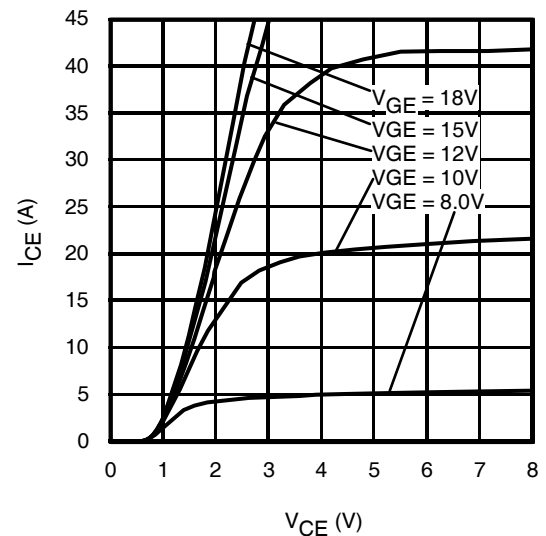

Fig. 6 - Typ. IGBT Output Characteristics
 $T_J = 25^\circ\text{C}$; $t_p = 80\mu\text{s}$

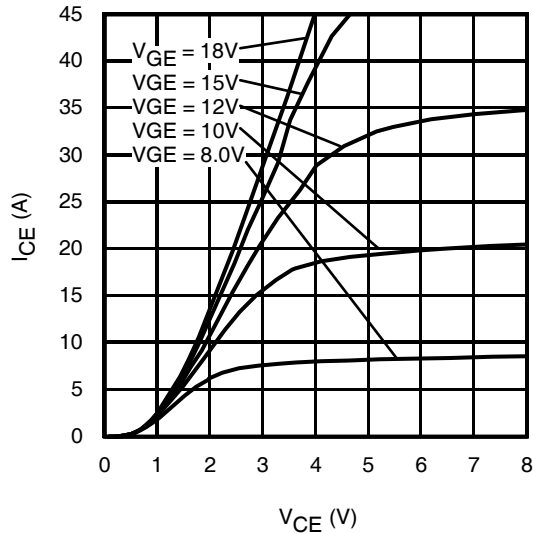

Fig. 7 - Typ. IGBT Output Characteristics
 $T_J = 175^\circ\text{C}$; $t_p = 80\mu\text{s}$

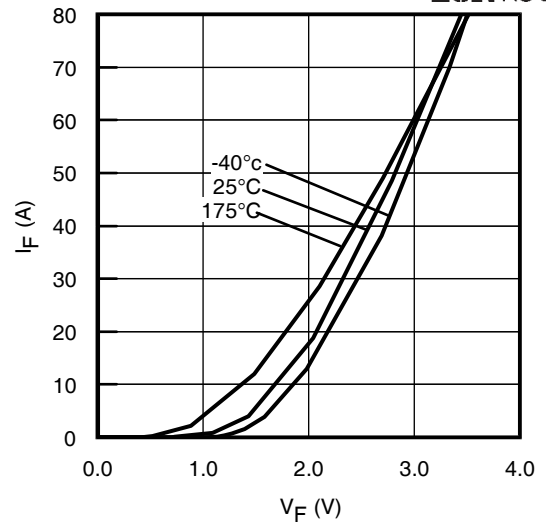

Fig. 8 - Typ. Diode Forward Characteristics
 $t_p = 80\mu\text{s}$

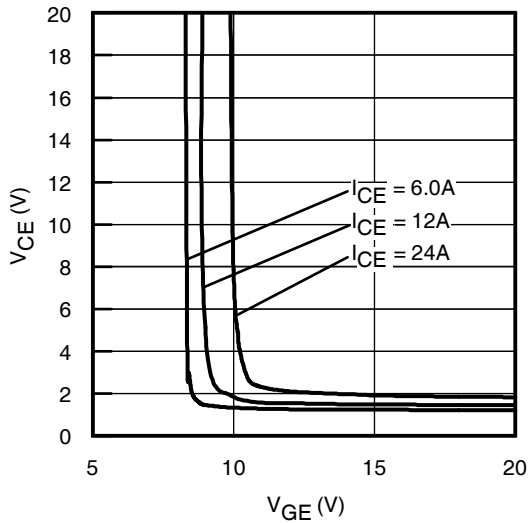

Fig. 9 - Typical V_{CE} vs. V_{GE}
 $T_J = -40^\circ\text{C}$

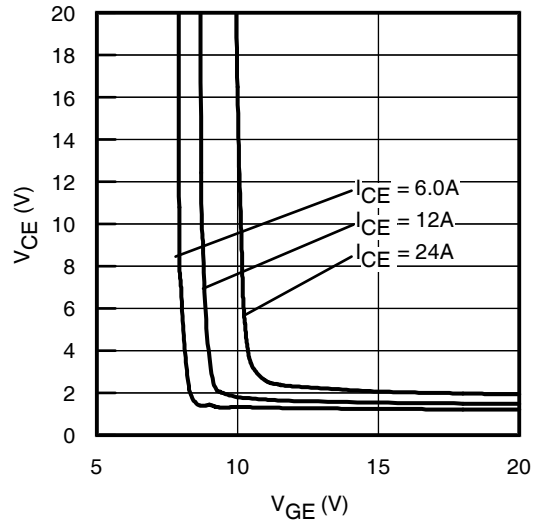

Fig. 10 - Typical V_{CE} vs. V_{GE}
 $T_J = 25^\circ\text{C}$

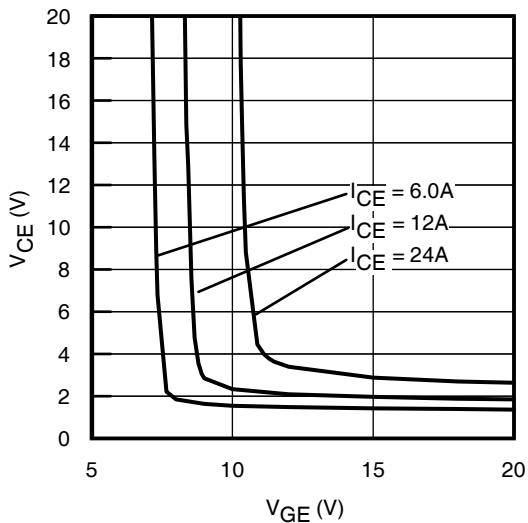

Fig. 11 - Typical V_{CE} vs. V_{GE}
 $T_J = 175^\circ\text{C}$

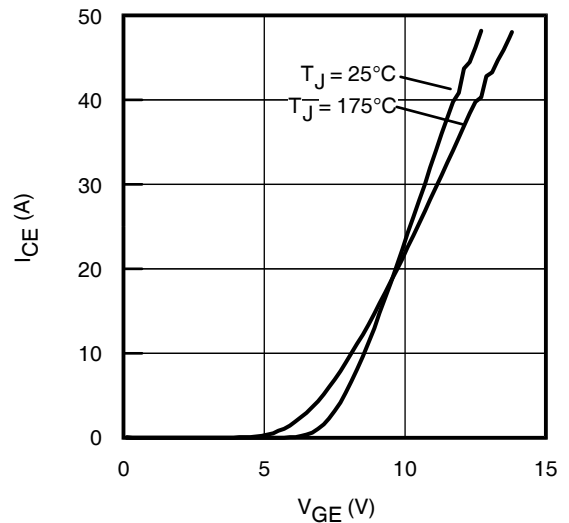

Fig. 12 - Typ. Transfer Characteristics
 $V_{CE} = 50\text{V}$; $t_p = 10\mu\text{s}$

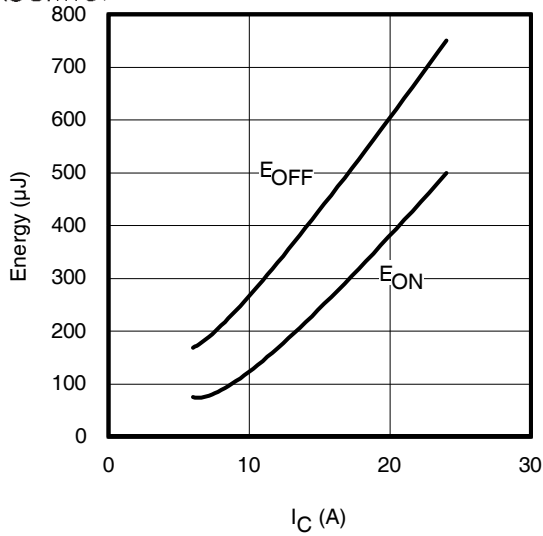

Fig. 13 - Typ. Energy Loss vs. I_C

$T_J = 175^\circ\text{C}$; $L = 200\mu\text{H}$; $V_{CE} = 400\text{V}$, $R_G = 22\Omega$; $V_{GE} = 15\text{V}$

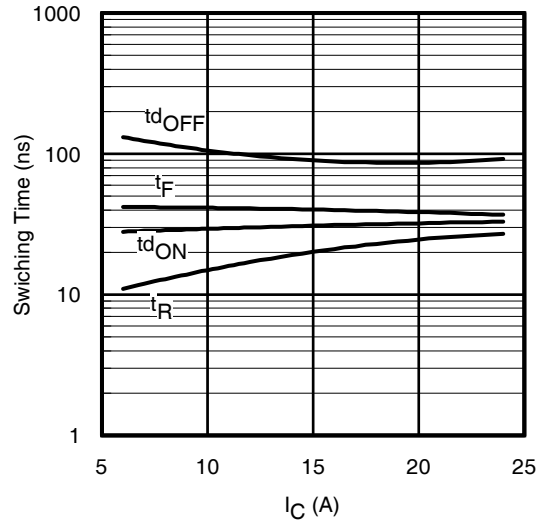

Fig. 14 - Typ. Switching Time vs. I_C

$T_J = 175^\circ\text{C}$; $L = 200\mu\text{H}$; $V_{CE} = 400\text{V}$, $R_G = 22\Omega$; $V_{GE} = 15\text{V}$

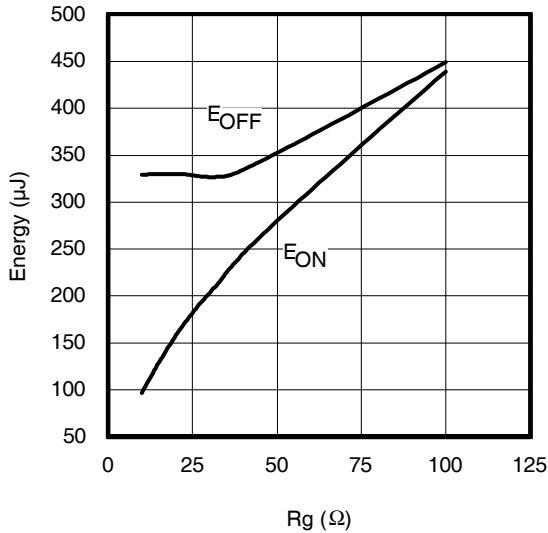

Fig. 15 - Typ. Energy Loss vs. R_G

$T_J = 175^\circ\text{C}$; $L = 200\mu\text{H}$; $V_{CE} = 400\text{V}$, $I_{CE} = 12\text{A}$; $V_{GE} = 15\text{V}$

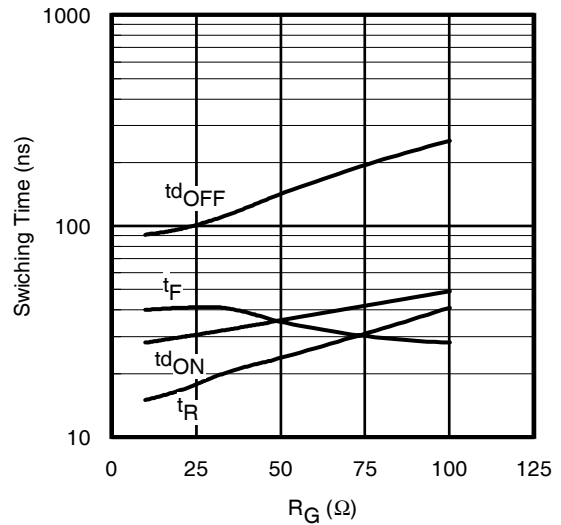

Fig. 16 - Typ. Switching Time vs. R_G

$T_J = 175^\circ\text{C}$; $L = 200\mu\text{H}$; $V_{CE} = 400\text{V}$, $I_{CE} = 12\text{A}$; $V_{GE} = 15\text{V}$

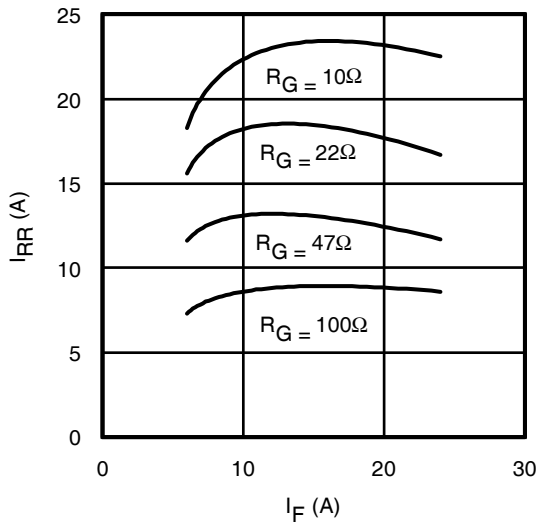

Fig. 17 - Typ. Diode I_{RR} vs. I_F

$T_J = 175^\circ\text{C}$

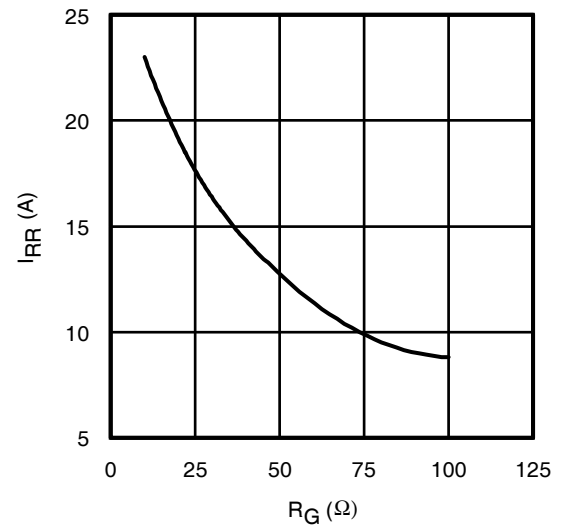

Fig. 18 - Typ. Diode I_{RR} vs. R_G

$T_J = 175^\circ\text{C}$

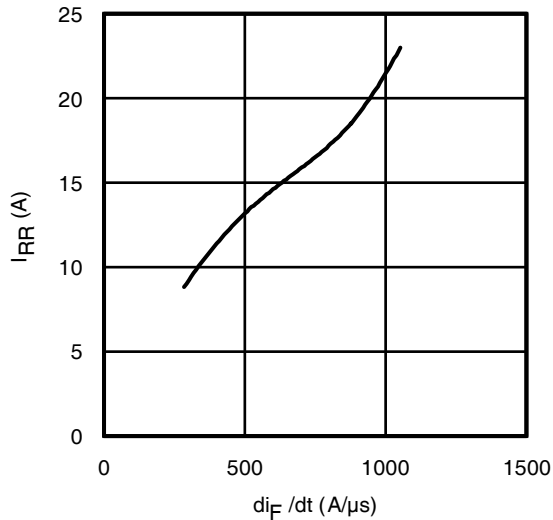

Fig. 19 - Typ. Diode I_{RR} vs. di_F/dt
 $V_{CC} = 400V$; $V_{GE} = 15V$; $I_F = 12A$; $T_J = 175^\circ C$

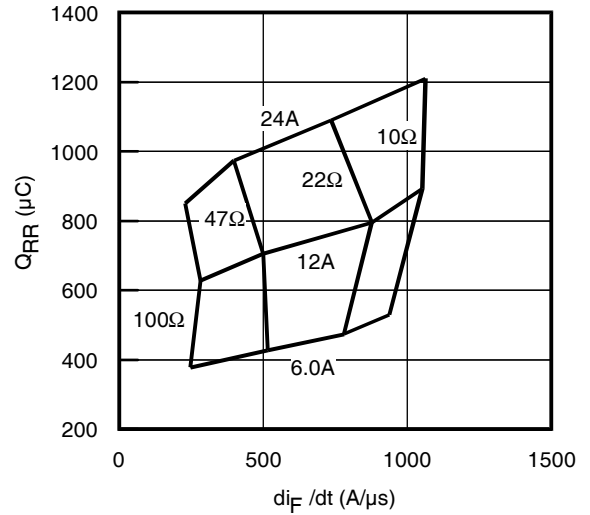

Fig. 20 - Typ. Diode Q_{RR} vs. di_F/dt
 $V_{CC} = 400V$; $V_{GE} = 15V$; $T_J = 175^\circ C$

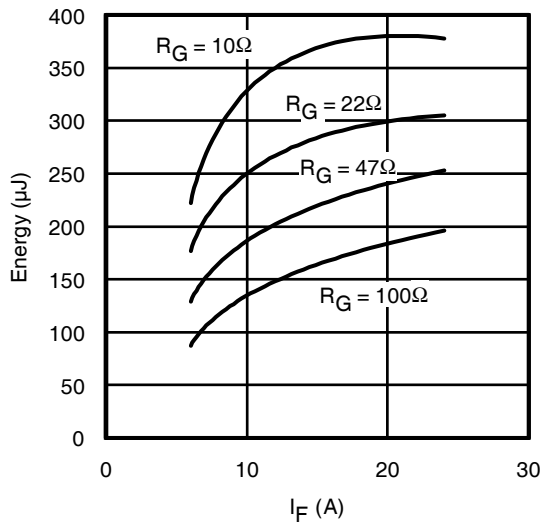

Fig. 21 - Typ. Diode E_{RR} vs. I_F
 $T_J = 175^\circ C$

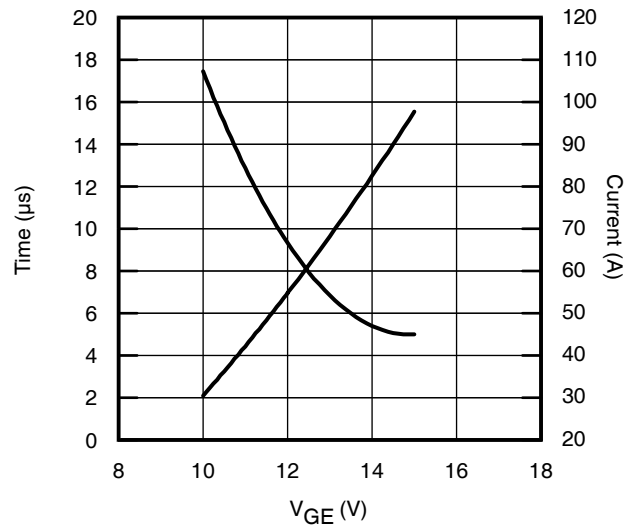

Fig. 22 - V_{GE} vs. Short Circuit Time
 $V_{CC} = 400V$; $T_C = 25^\circ C$

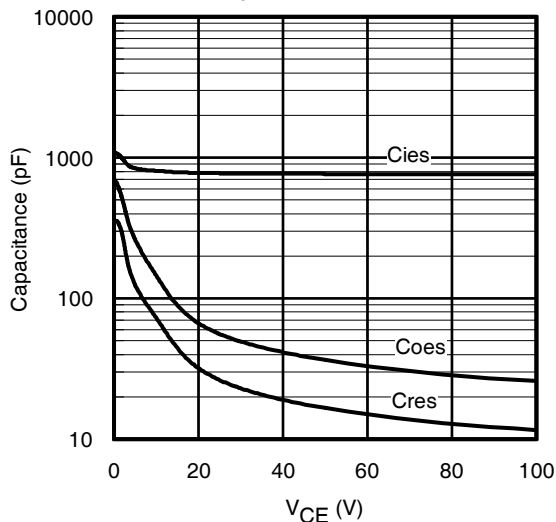

Fig. 23 - Typ. Capacitance vs. V_{CE}
 $V_{GE} = 0V$; $f = 1MHz$

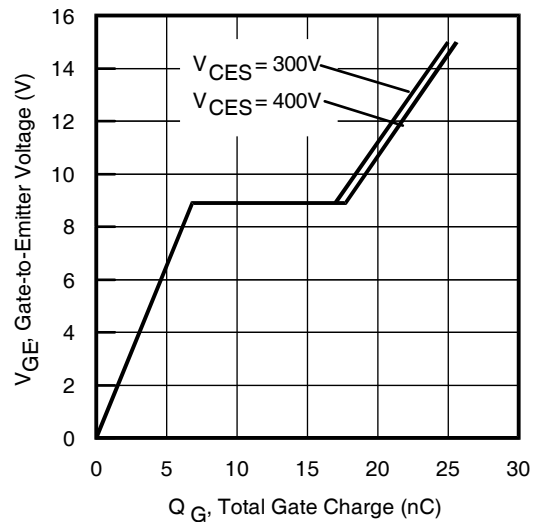

Fig. 24 - Typical Gate Charge vs. V_{GE}
 $I_{CE} = 12A$; $L = 600\mu H$

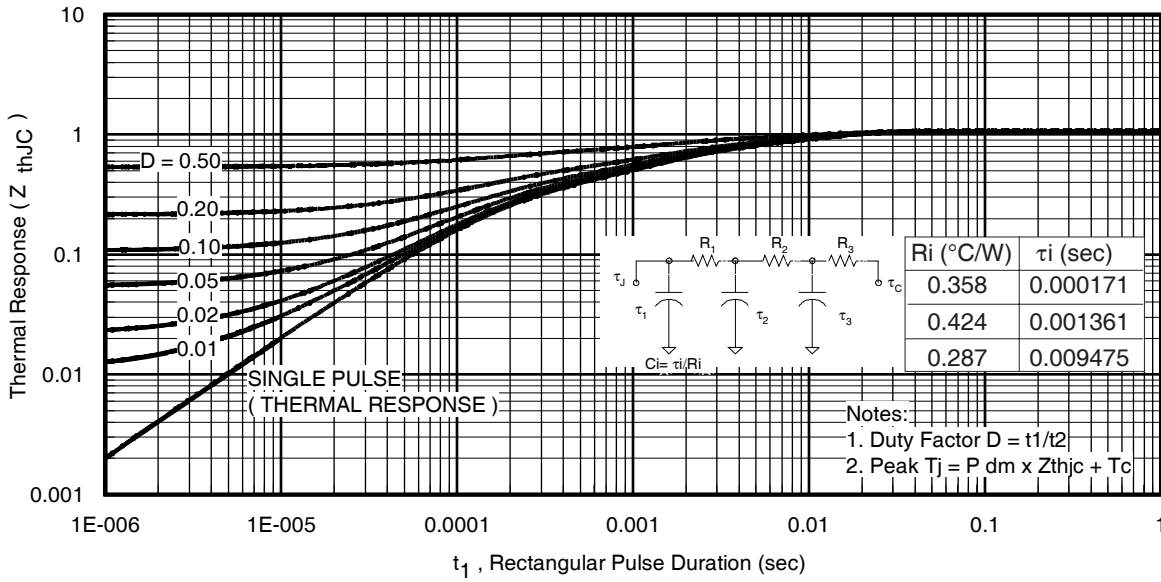

Fig 25. Maximum Transient Thermal Impedance, Junction-to-Case (IGBT)

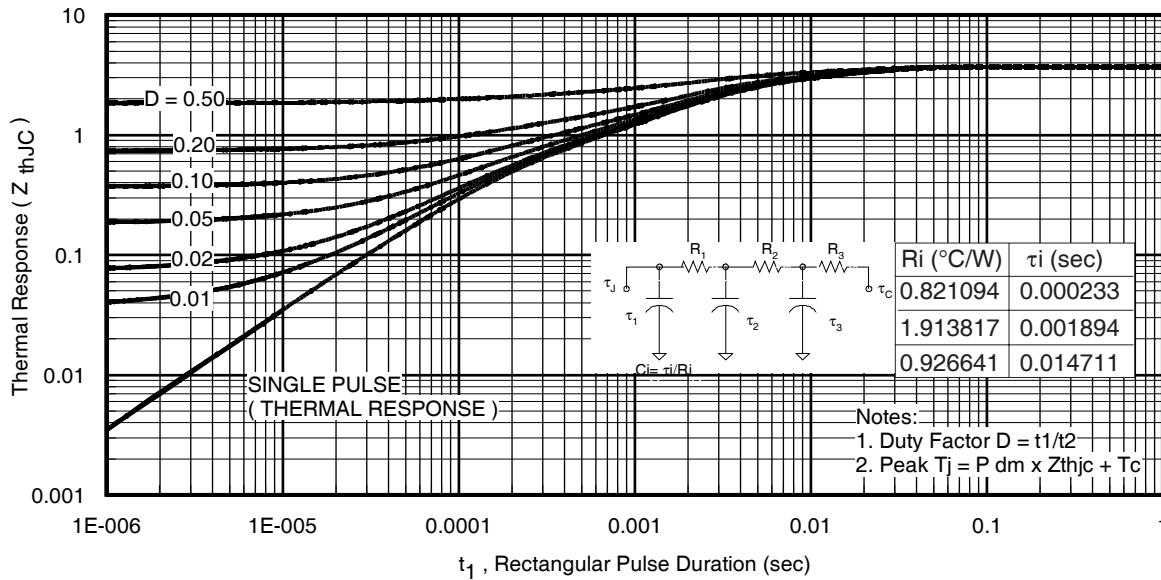

Fig. 26. Maximum Transient Thermal Impedance, Junction-to-Case (DIODE)

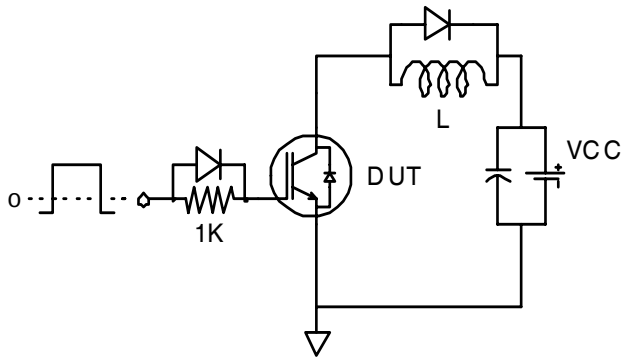

Fig.C.T.1 - Gate Charge Circuit (turn-off)

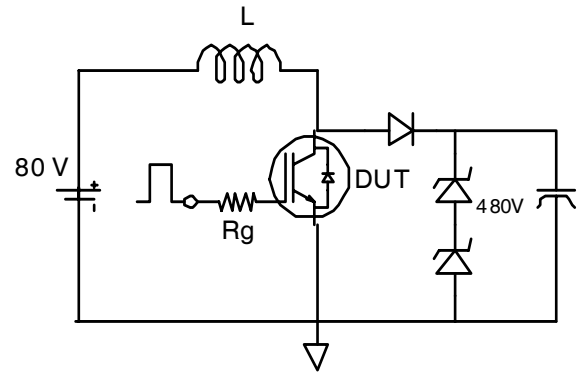

Fig.C.T.2 - RBSOA Circuit

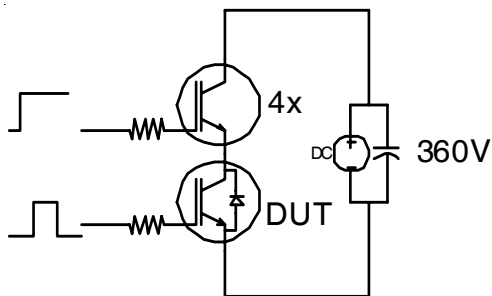

Fig.C.T.3 - S.C. SOA Circuit

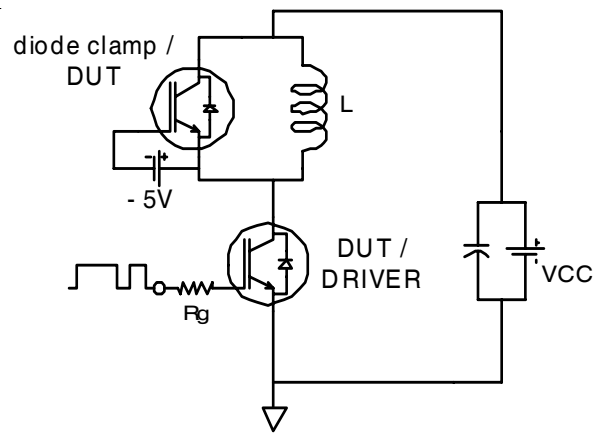

Fig.C.T.4 - Switching Loss Circuit

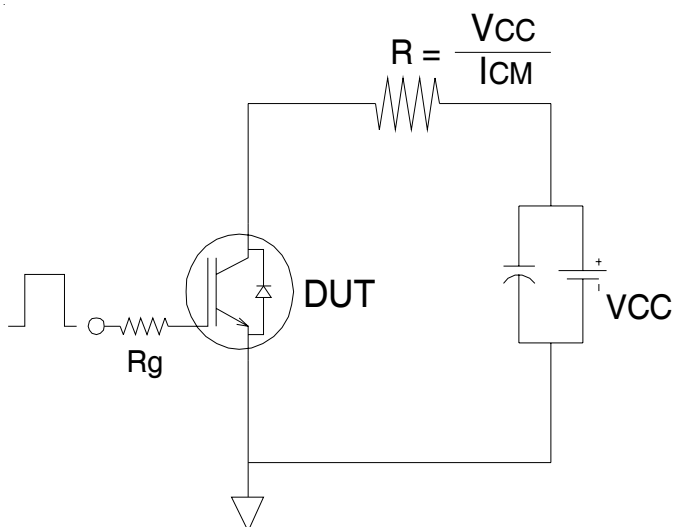

Fig.C.T.5 - Resistive Load Circuit

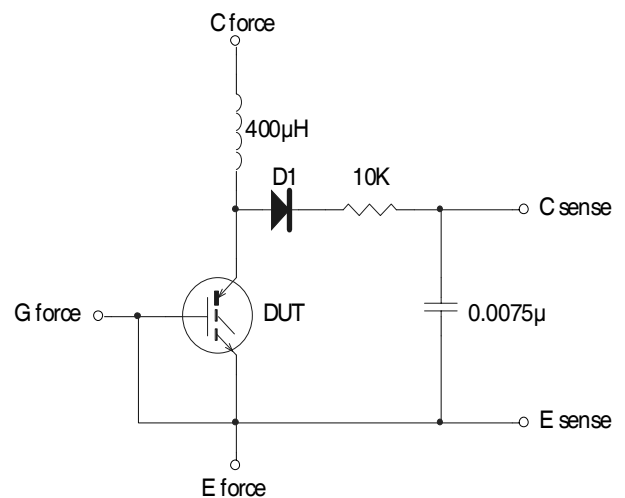

Fig.C.T.6 - BVCES Filter Circuit

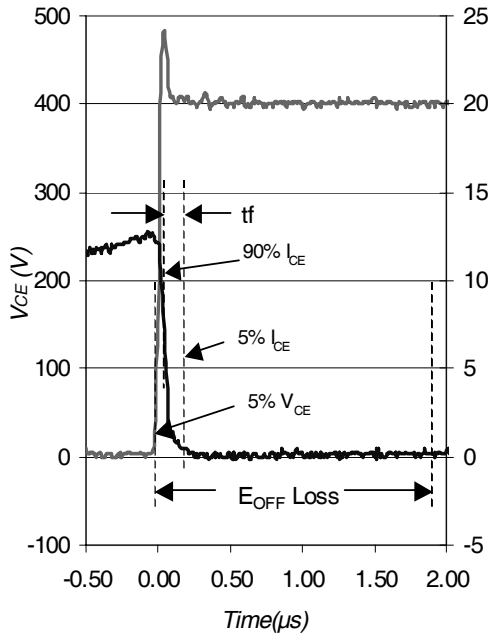

Fig. WF1 - Typ. Turn-off Loss Waveform
@ $T_J = 175^\circ\text{C}$ using Fig. CT.4

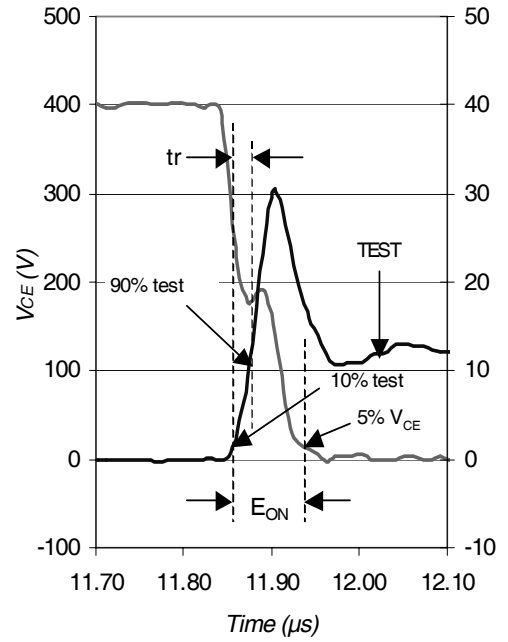

Fig. WF2 - Typ. Turn-on Loss Waveform
@ $T_J = 175^\circ\text{C}$ using Fig. CT.4

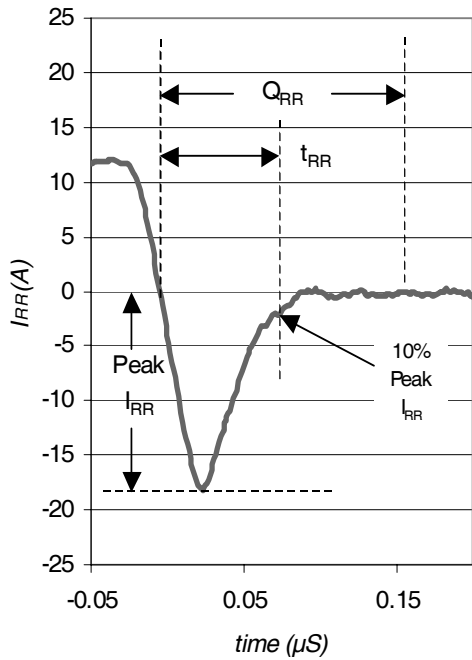

Fig. WF3 - Typ. Diode Recovery Waveform
@ $T_J = 175^\circ\text{C}$ using Fig. CT.4

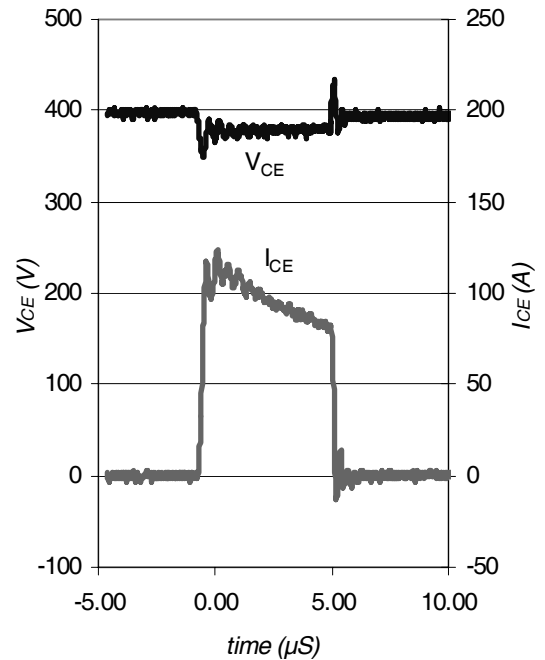
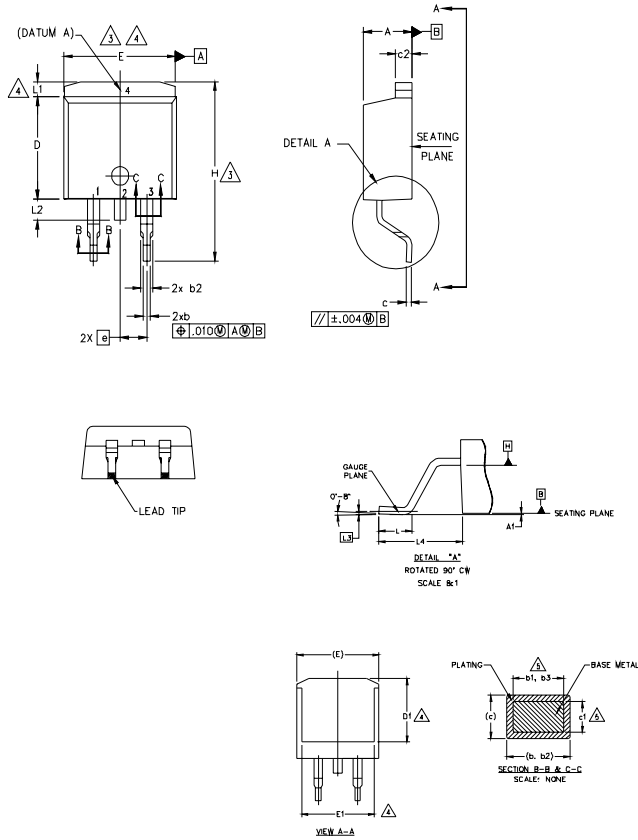

Fig. WF4 - Typ. S.C. Waveform
@ $T_J = 25^\circ\text{C}$ using Fig. CT.3

D²Pak (TO-263AB) Package Outline

Dimensions are shown in millimeters (inches)



NOTES:

1. DIMENSIONING AND TOLERANCING PER ASME Y14.5M-1994
2. DIMENSIONS ARE SHOWN IN MILLIMETERS [INCHES].
3. DIMENSION D & E DO NOT INCLUDE MOLD FLASH. MOLD FLASH SHALL NOT EXCEED 0.127 [.005"] PER SIDE. THESE DIMENSIONS ARE MEASURED AT THE OUTMOST EXTREMES OF THE PLASTIC BODY AT DATUM H.
4. THERMAL PAD CONTOUR OPTIONAL WITHIN DIMENSION E, L1, D1 & E1.
5. DIMENSION b1 AND c1 APPLY TO BASE METAL ONLY.
6. DATUM A & B TO BE DETERMINED AT DATUM PLANE H.
7. CONTROLLING DIMENSION: INCH.
8. OUTLINE CONFORMS TO JEDEC OUTLINE TO-263AB.

SYMBOL	DIMENSIONS				NOTES
	MILLIMETERS		INCHES		
	MIN.	MAX.	MIN.	MAX.	
A	4.06	4.83	.160	.190	
A1	0.00	0.254	.000	.010	
b	0.51	0.99	.020	.039	
b1	0.51	0.89	.020	.035	5
b2	1.14	1.78	.045	.070	
b3	1.14	1.73	.045	.068	5
c	0.38	0.74	.015	.029	
c1	0.38	0.58	.015	.023	5
c2	1.14	1.65	.045	.065	
D	8.38	9.65	.330	.380	3
D1	6.86	-	.270	-	4
E	9.65	10.67	.380	.420	3,4
E1	6.22	-	.245	-	4
e	2.54 BSC		.100 BSC		
H	14.61	15.88	.575	.625	
L	1.78	2.79	.070	.110	
L1	-	1.65	-	.066	4
L2	1.27	1.78	-	.070	
L3	0.25 BSC		.010 BSC		
L4	4.78	5.28	.188	.208	

LEAD ASSIGNMENTS

HEXFET

- 1.- GATE
- 2, 4.- DRAIN
- 3.- SOURCE

IGBTs, CoPACK

- 1.- GATE
- 2, 4.- COLLECTOR
- 3.- EMITTER

DIODES

- 1.- ANODE *
- 2, 4.- CATHODE
- 3.- ANODE

* PART DEPENDENT.

D²Pak (TO-263AB) Part Marking Information

EXAMPLE: THIS IS AN IRF530S WITH
LOT CODE 8024
ASSEMBLED ON WW 02, 2000
IN THE ASSEMBLY LINE "L"

Note: "P" in assembly line position
indicates "Lead - Free"

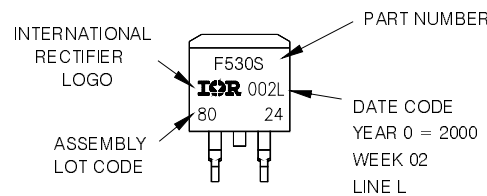

OR

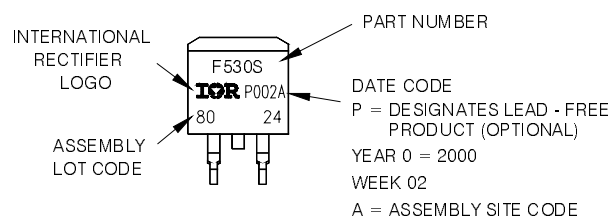

Note: For the most current drawing please refer to IR website at <http://www.irf.com/package/>

D²Pak (TO-263AB) Tape & Reel Information

Dimensions are shown in millimeters (inches)

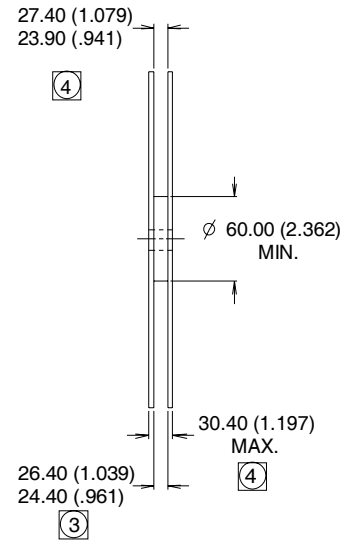
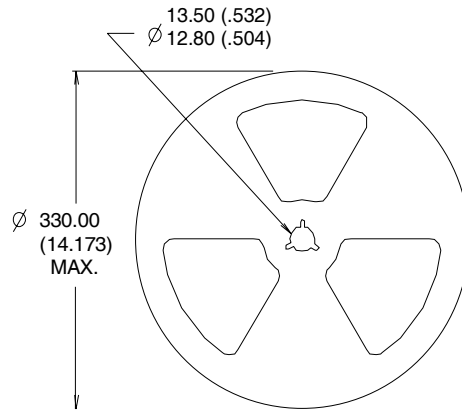
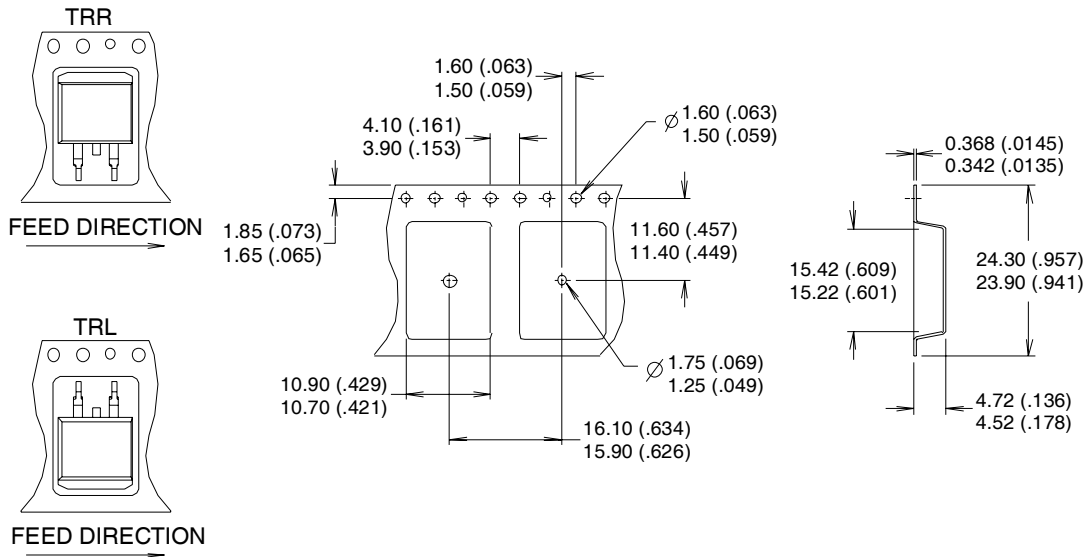

NOTES :

1. COMFORMS TO EIA-418.
2. CONTROLLING DIMENSION: MILLIMETER.
- ③ DIMENSION MEASURED @ HUB.
- ④ INCLUDES FLANGE DISTORTION @ OUTER EDGE.

Note: For the most current drawing please refer to IR website at <http://www.irf.com/package/>

Data and specifications subject to change without notice.
 This product has been designed and qualified for Industrial market.
 Qualification Standards can be found on IR's Web site.