

ACR1504I3

Request Samples



Check Inventory



15.0 x 4.0 x 1.2 mm
RoHS/RoHS II Compliant
MSL Level = N/A

Features

- Multiband Coverage with Matching
 - LPWA/ISM - 433 / 868 / 915 MHz
- Low Profile Antenna
- Ideal Omni-directional patterns
- High Efficiency at 868 & 915 MHz
- Peak Gains
 - 2.11 dBi (915 MHz)
 - 1.75 dBi (868 MHz)

Applications

- IoT – Industrial, Medical, Infrastructure
- M2M/ V2X/ UAV
- LoRA/ SigFox / RFID / ISM
- Medical Devices
- Home Automation
- Smart Meters
- Remote Monitoring

Product Dimension

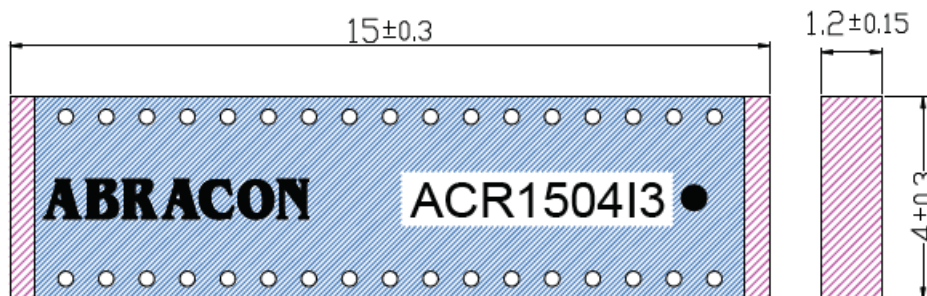

Unit : mm

ACR1504I3

Request Samples



Check Inventory



15.0 x 4.0 x 1.2 mm
RoHS/RoHS II Compliant
MSL Level = N/A

Electrical Specification

Parameter	Specification			Unit
Operating Frequency	433	868	915	MHz
Peak Gain*	-4.4	1.75	2.11	dBi
Impedance	50			Ω
Polarization	Linear			
Radiation Pattern (Azimuth)	Omni-directional			

* All test measurements were conducted with the antenna on a 105x35 mm Evaluation board. Please note that the performance is dependent on the ground plane dimensions.

Mechanical Specification

Parameter	Specification
Antenna Dimension	15 x 4 x 1.2 mm
Standard Evaluation Board Dimension	105 x 35 mm
Mounting Type	SMD

Environmental Specification

Parameter	Specification
Operating Temperature	-40 °C to +85 °C
Storage Temperature	0 °C to +40 °C
Relative Humidity	20~80 %
RoHS Compliance	Yes
Pb-free	Yes

ACR1504I3

Request Samples



Check Inventory



15.0 x 4.0 x 1.2 mm
RoHS/RoHS II Compliant
 MSL Level = N/A

Evaluation Board Dimension

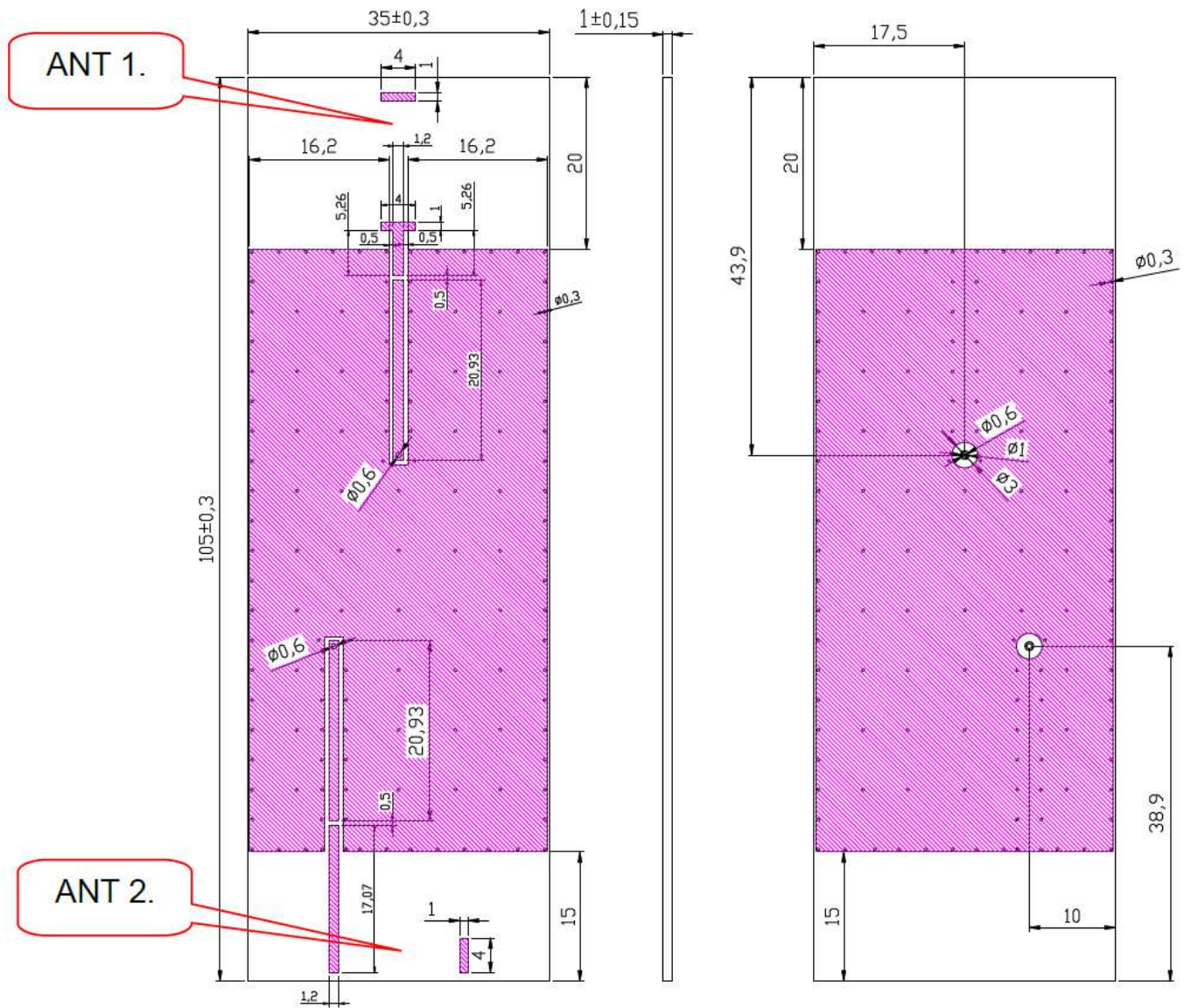

Unit : mm

915/868/433 MHz : LPWA/ISM Multiband Chip Antenna



ACR1504I3

Request Samples



Check Inventory



15.0 x 4.0 x 1.2 mm
RoHS/RoHS II Compliant
 MSL Level = N/A

Chip Layout & Matching Circuit

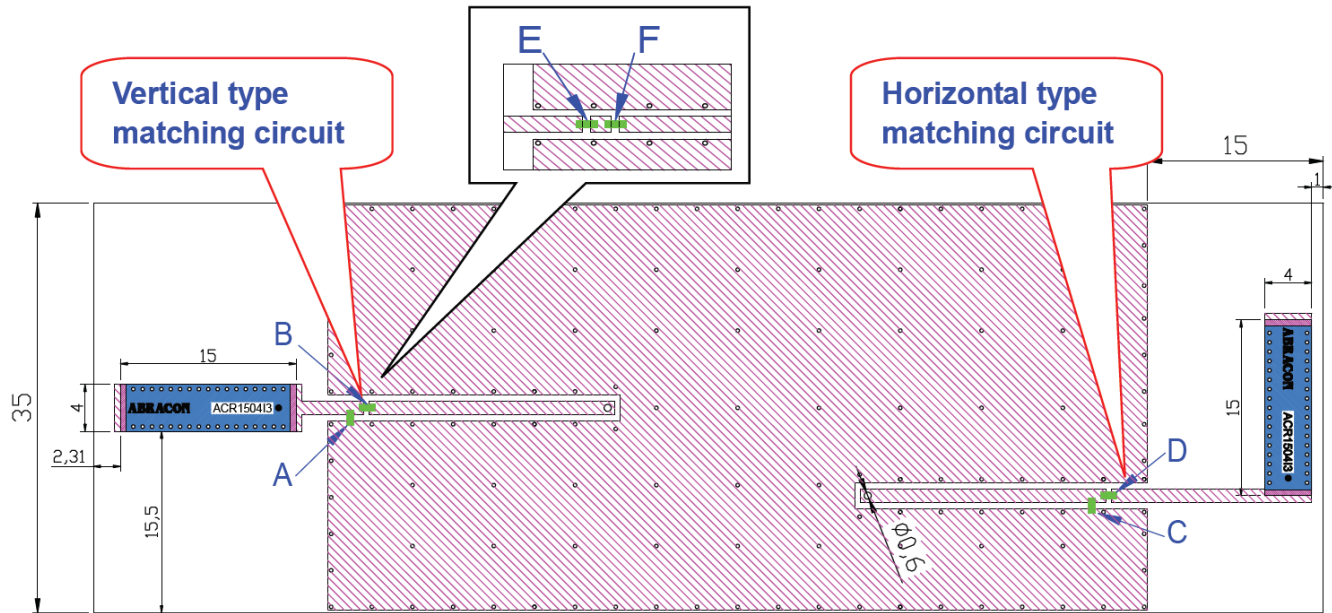

Unit : mm

Frequency	915 MHz		868 MHz		433 MHz	
Vertical Type (Ant 1)	A = 12 nH	B = 33 nH	A = 0.5 pF	B = 5.6 pF	E = 82 nH	F = 15 nH
Horizontal Type (Ant 2)	C = 6.8 nH	D = 4.7 nH	D = 1.5 pF		D = 91 nH	



5101 Hidden Creek Ln Spicewood TX 78669
 Phone: 512-371-6159 | Fax: 512-351-8858
 For terms and conditions of sales, please visit:
www.abracon.com

REVISED: 07-19-21

ABRACON IS
 ISO9001-2015
 CERTIFIED

915/868/433 MHz : LPWA/ISM Multiband Chip Antenna

ABRACON ACR1504I3

ACR1504I3

Request Samples



Check Inventory



15.0 x 4.0 x 1.2 mm
RoHS/RoHS II Compliant
MSL Level = N/A

Test Measurement – Return Loss

Antenna 1 :

915 MHz

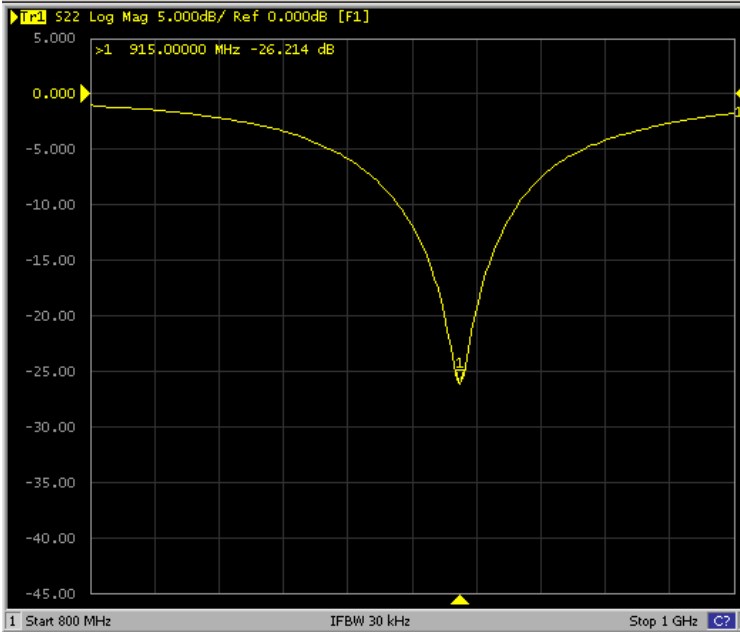

868 MHz

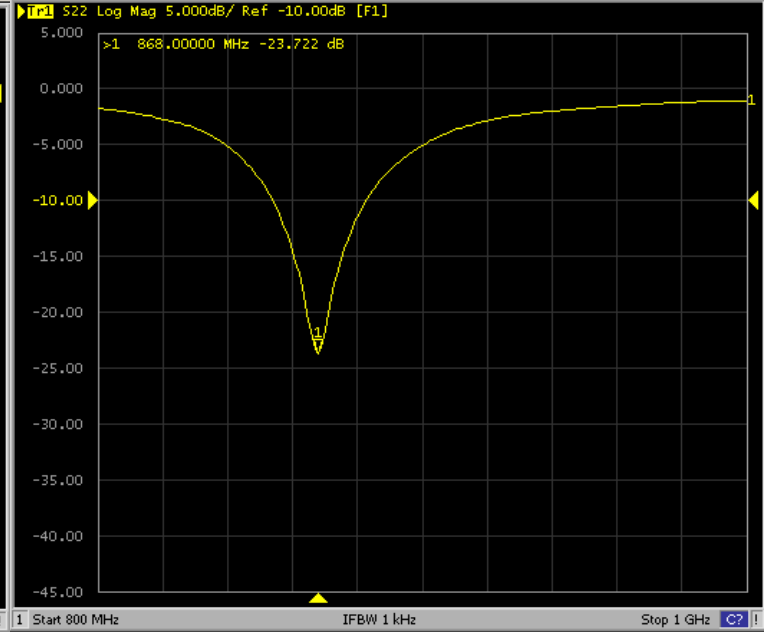

433 MHz

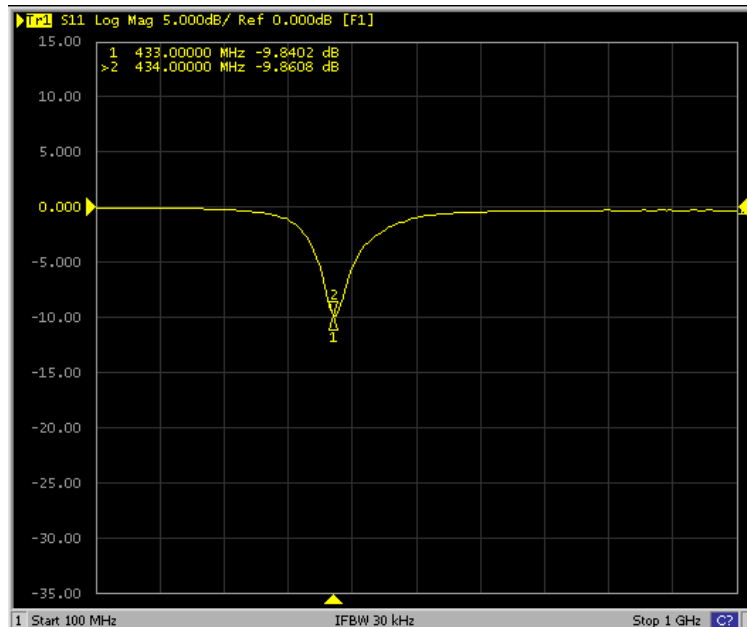

5101 Hidden Creek Ln Spicewood TX 78669
Phone: 512-371-6159 | Fax: 512-351-8858
For terms and conditions of sales, please visit:
www.abracon.com

REVISED: 07-19-21

ABRACON IS
ISO9001-2015
CERTIFIED

915/868/433 MHz : LPWA/ISM Multiband Chip Antenna

ABRACON ACR150413

ACR150413

Request Samples



Check Inventory



15.0 x 4.0 x 1.2 mm
RoHS/RoHS II Compliant
MSL Level = N/A

Antenna 2 :

915 MHz

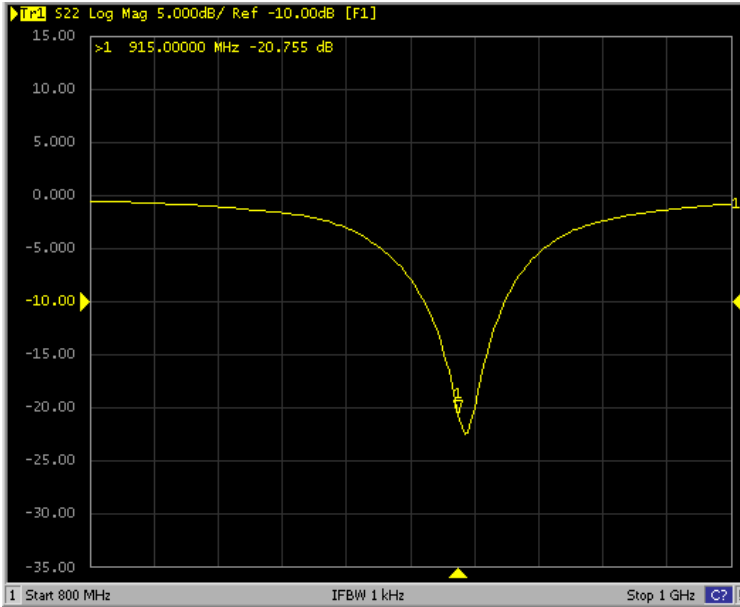

868 MHz

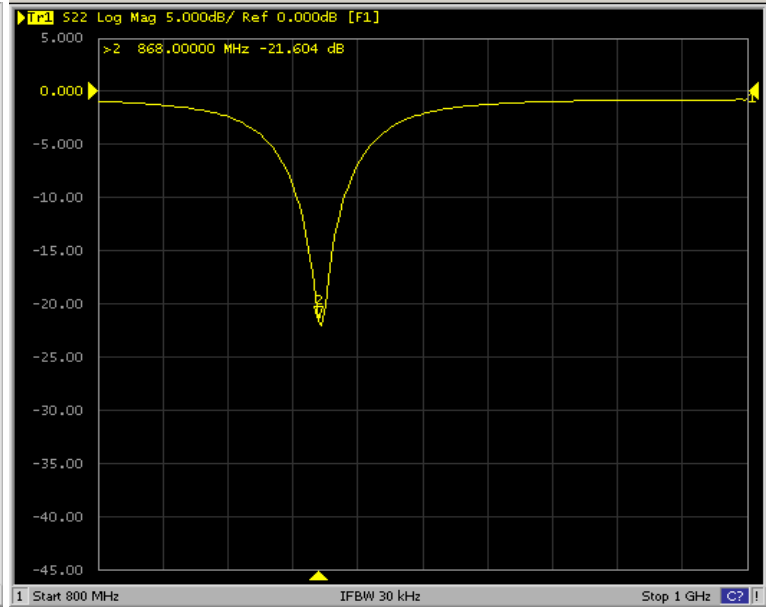

433 MHz

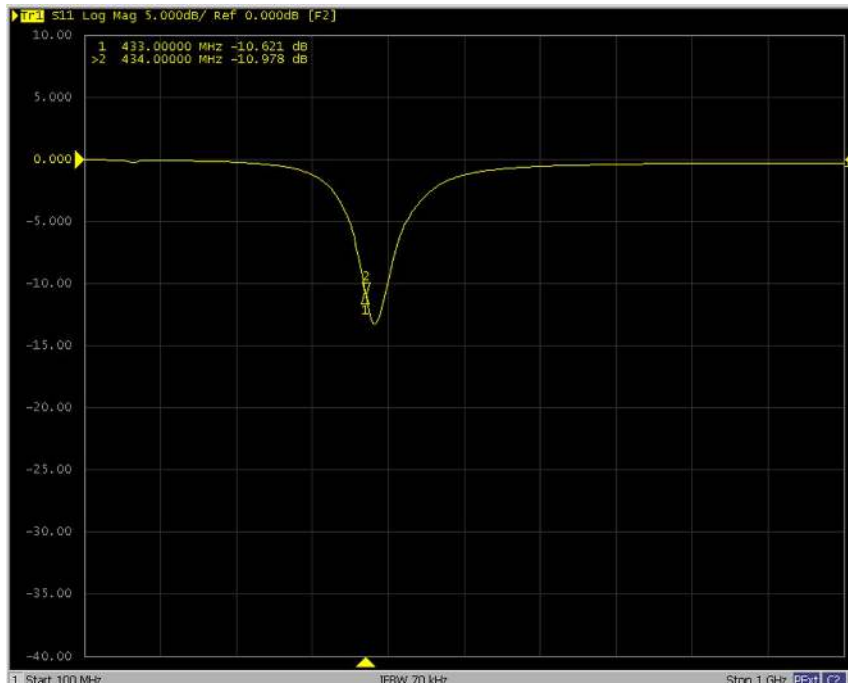

5101 Hidden Creek Ln Spicewood TX 78669
Phone: 512-371-6159 | Fax: 512-351-8858
For terms and conditions of sales, please visit:
www.abracon.com

REVISED: 07-19-21

ABRACON IS
ISO9001-2015
CERTIFIED

ACR1504I3

Request Samples



Check Inventory



15.0 x 4.0 x 1.2 mm
 RoHS/RoHS II Compliant
 MSL Level = N/A

Radiation Characteristics – 3D Pattern

Orientation

Antenna 1

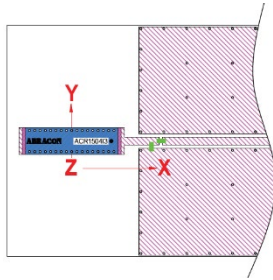

Antenna 2

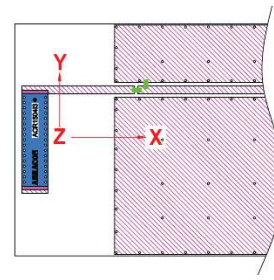

Antenna 1

433 MHz

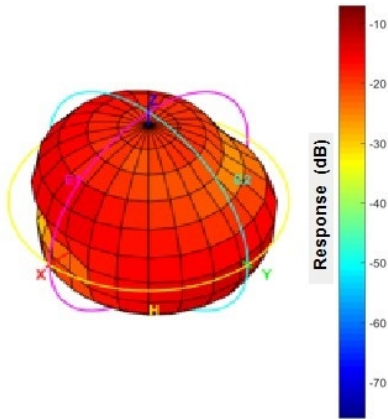

868 MHz

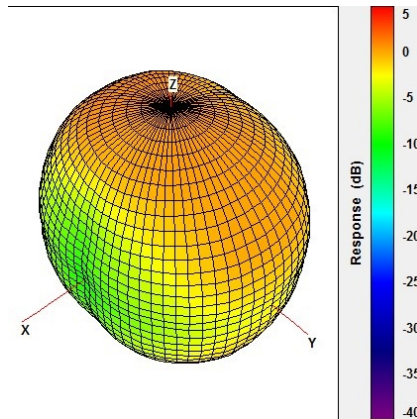

915 MHz

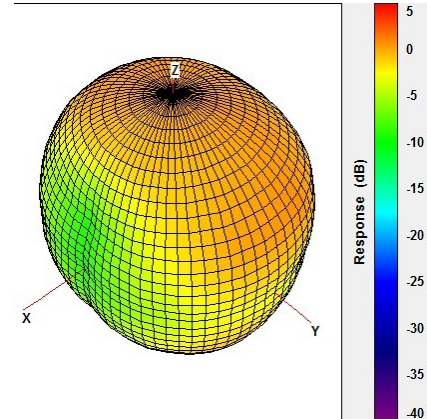

Antenna 2

433 MHz

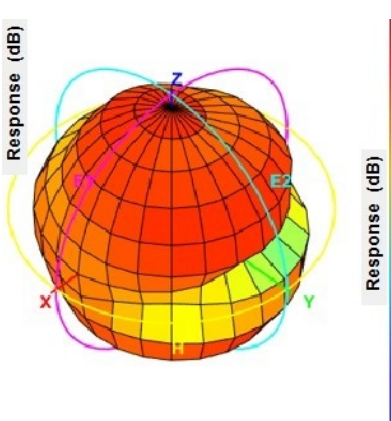

868 MHz

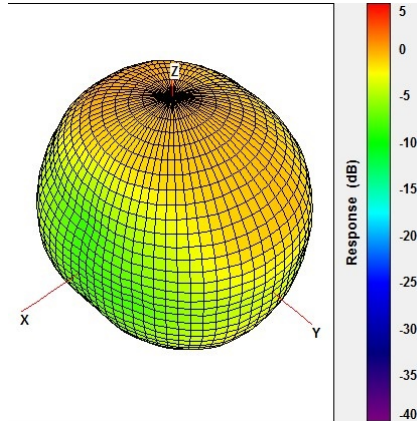

915 MHz

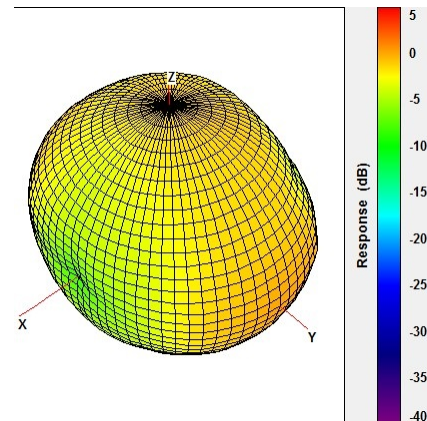

ACR1504I3

Request Samples



Check Inventory



15.0 x 4.0 x 1.2 mm
RoHS/RoHS II Compliant
 MSL Level = N/A

Radiation Characteristics - 2D Pattern

Antenna 1 : 915 MHz

XY - Plane

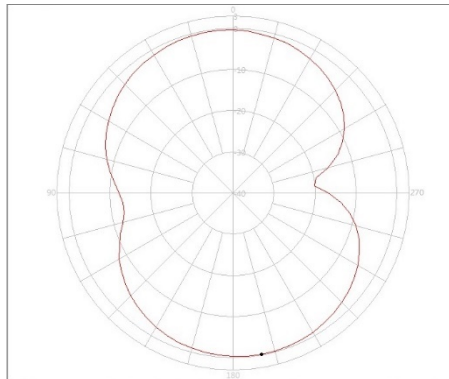

XZ - Plane

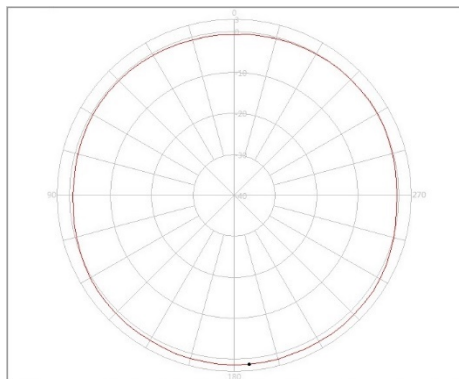

YZ - Plane

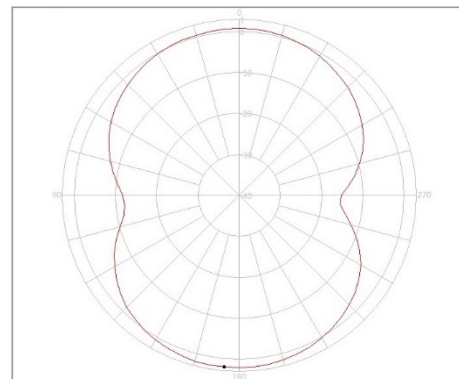

Frequency	Peak Gain (dBi)		
	XZ	YZ	XY
915 MHz	1.41	2.11	-0.20

915/868/433 MHz : LPWA/ISM Multiband Chip Antenna



ACR1504I3

Request Samples



Check Inventory



15.0 x 4.0 x 1.2 mm
RoHS/RoHS II Compliant
 MSL Level = N/A

Antenna 1 : 868 MHz

XY - Plane

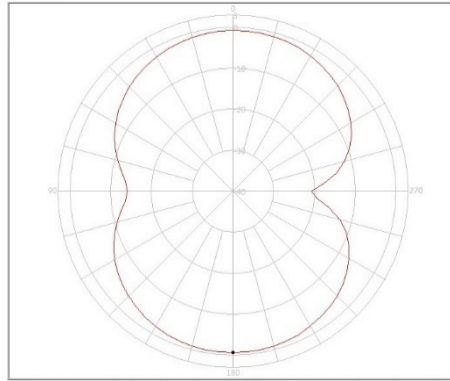

XZ - Plane

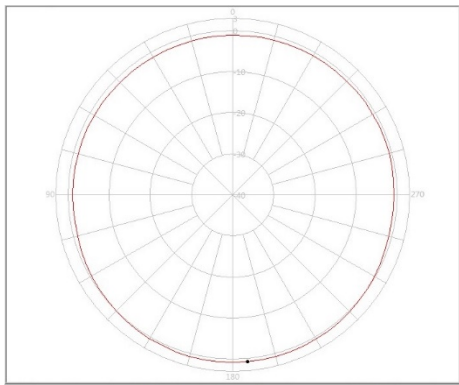

YZ - Plane

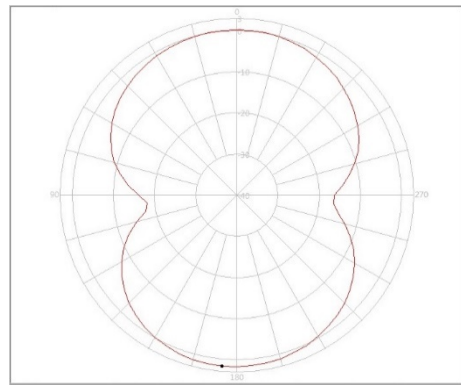

Frequency	Peak Gain (dBi)		
	XZ	YZ	XY
868 MHz	0.86	1.75	-0.57



5101 Hidden Creek Ln Spicewood TX 78669
 Phone: 512-371-6159 | Fax: 512-351-8858
 For terms and conditions of sales, please visit:
www.abracon.com

REVISED: 07-19-21

ABRACON IS
 ISO9001-2015
 CERTIFIED

915/868/433 MHz : LPWA/ISM Multiband Chip Antenna



ACR1504I3

Request Samples



Check Inventory



15.0 x 4.0 x 1.2 mm
RoHS/RoHS II Compliant
MSL Level = N/A

Antenna 1 : 433 MHz

XY - Plane

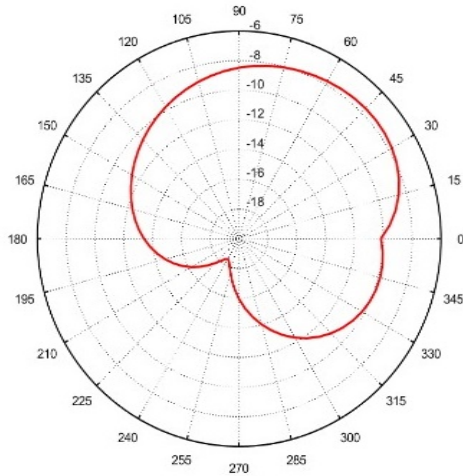

XZ - Plane

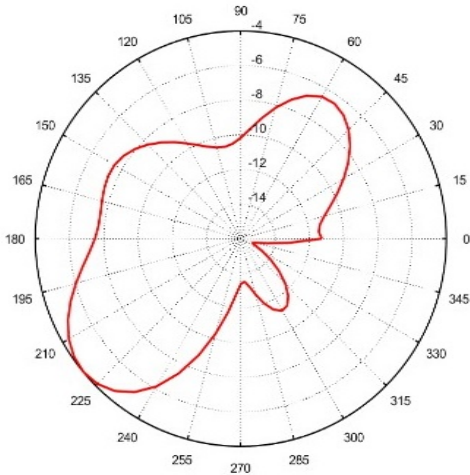

YZ - Plane

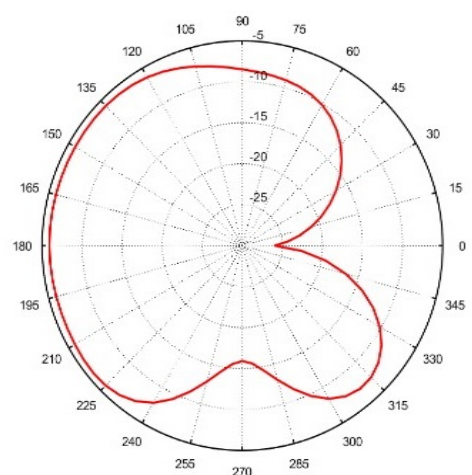

Frequency	Peak Gain (dBi)		
	XZ	YZ	XY
433 MHz	-7.75	-4.4	-5.87



5101 Hidden Creek Ln Spicewood TX 78669
 Phone: 512-371-6159 | Fax: 512-351-8858
 For terms and conditions of sales, please visit:
www.abracon.com

REVISED: 07-19-21

ABRACON IS
 ISO9001-2015
 CERTIFIED

915/868/433 MHz : LPWA/ISM Multiband Chip Antenna



ACR1504I3

Request Samples



Check Inventory



15.0 x 4.0 x 1.2 mm
RoHS/RoHS II Compliant
 MSL Level = N/A

Antenna 2 : 915 MHz

XY - Plane

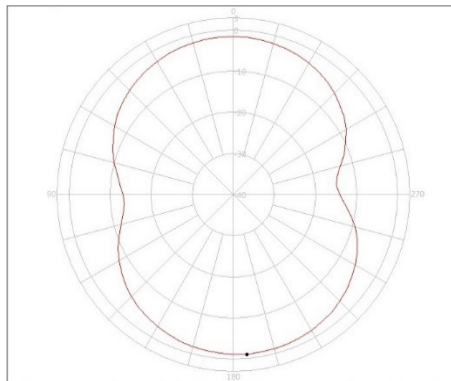

XZ - Plane

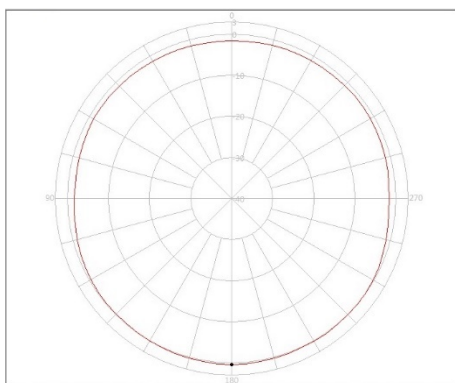

YZ - Plane

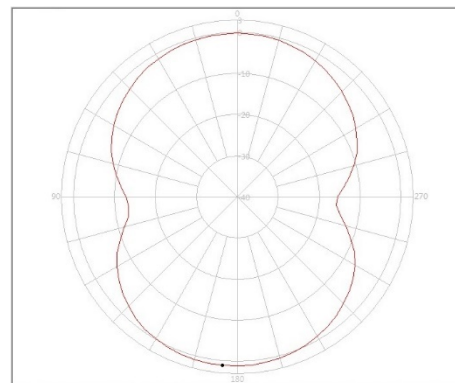

Frequency	Peak Gain (dBi)		
	XZ	YZ	XY
915 MHz	0.40	1.17	-1.04



5101 Hidden Creek Ln Spicewood TX 78669
 Phone: 512-371-6159 | Fax: 512-351-8858
 For terms and conditions of sales, please visit:
www.abracon.com

REVISED: 07-19-21

ABRACON IS
 ISO9001-2015
 CERTIFIED

915/868/433 MHz : LPWA/ISM Multiband Chip Antenna



ACR1504I3

Request Samples



Check Inventory



15.0 x 4.0 x 1.2 mm
RoHS/RoHS II Compliant
 MSL Level = N/A

Antenna 2 : 868 MHz

XY - Plane

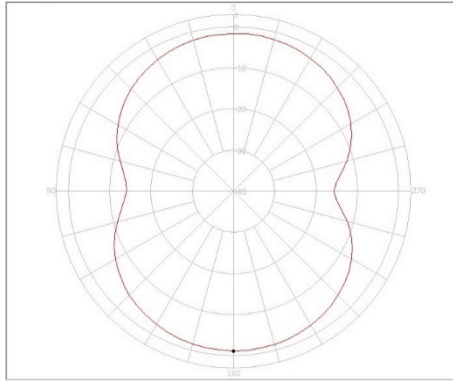

XZ - Plane

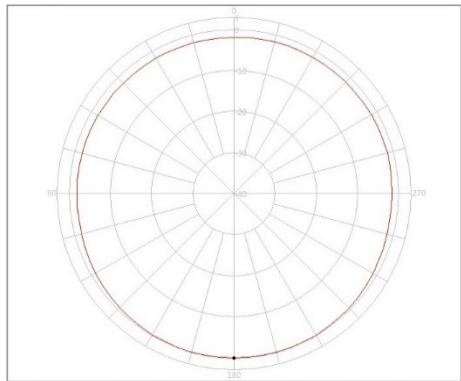

YZ - Plane

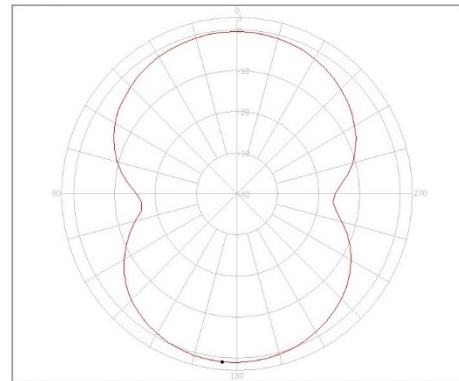

Frequency	Peak Gain (dBi)		
	XZ	YZ	XY
868 MHz	0.18	1.05	-1.17



5101 Hidden Creek Ln Spicewood TX 78669
 Phone: 512-371-6159 | Fax: 512-351-8858
 For terms and conditions of sales, please visit:
www.abracon.com

REVISED: 07-19-21

ABRACON IS
 ISO9001-2015
 CERTIFIED

ACR1504I3

Request Samples



Check Inventory



15.0 x 4.0 x 1.2 mm
RoHS/RoHS II Compliant
 MSL Level = N/A

Antenna 2 : 433 MHz

XY - Plane

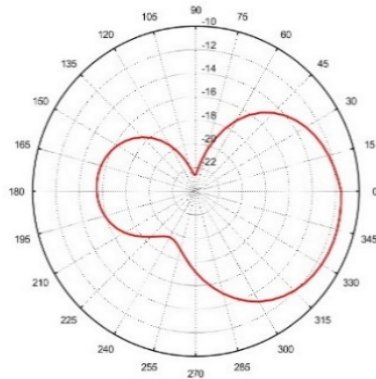

XZ - Plane

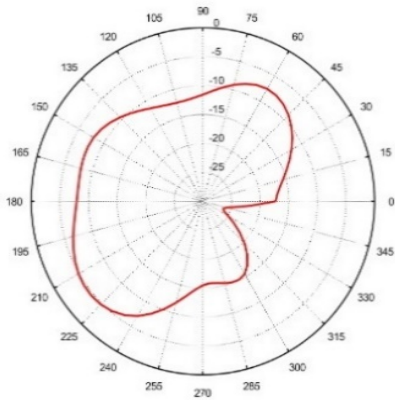

YZ - Plane

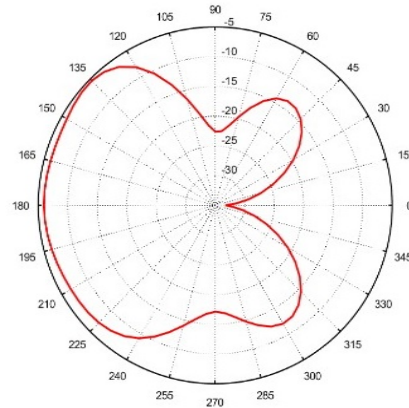

Frequency	Peak Gain (dBi)		
	XZ	YZ	XY
433 MHz	-11.55	-4.9	-5.95

915/868/433 MHz : LPWA/ISM Multiband Chip Antenna

ABRACON ACR150413

ACR150413

Request Samples



Check Inventory



15.0 x 4.0 x 1.2 mm
RoHS/RoHS II Compliant
MSL Level = N/A

Efficiency

Antenna 1 :

915 MHz

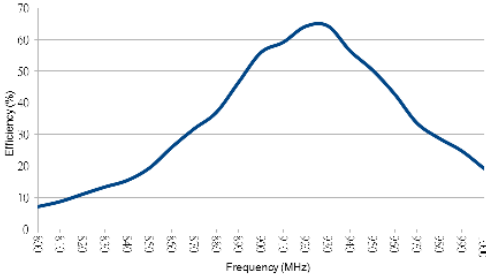

868 MHz

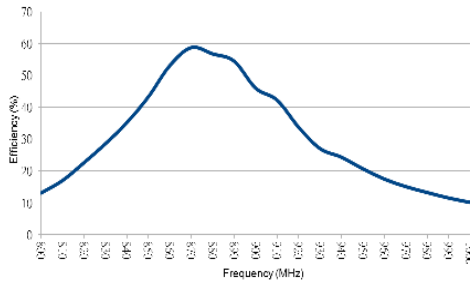

433 MHz

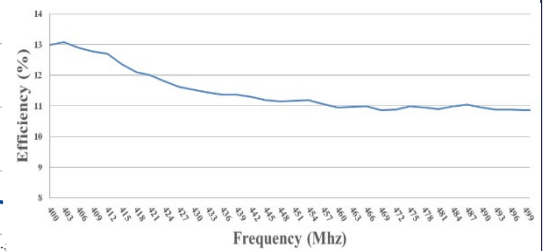

Antenna 2 :

915 MHz

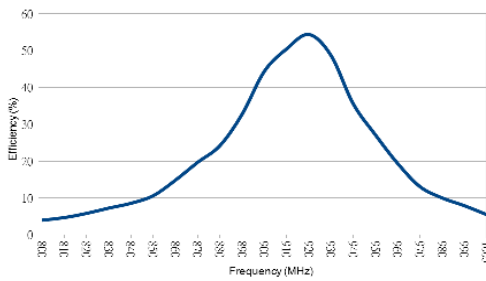

868 MHz

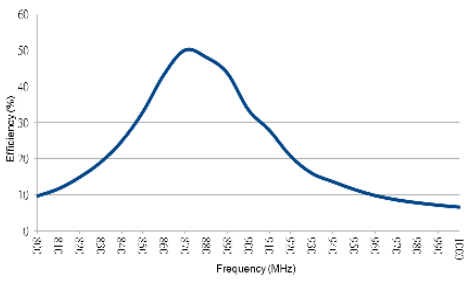

433 MHz

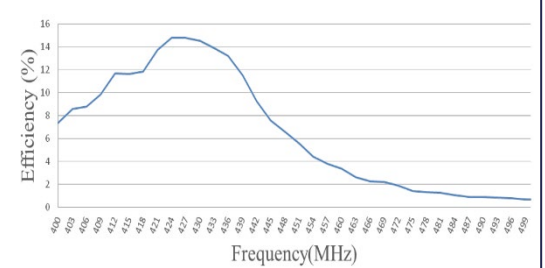

ACR150413

Request Samples



Check Inventory



15.0 x 4.0 x 1.2 mm
RoHS/RoHS II Compliant
MSL Level = N/A

Reliability Test

Test Condition	Test Exposure and Duration
Low Temperature test	Expose the specimen to -40°C for 16 hours and then to normal temperature/ humidity for 24 hours or more. After this test, examine its appearance and functions.
High-temperature test	Expose the specimen to +85°C for 16 hours and then to normal temperature / humidity for 24 hours or more. After this test, examine its appearance and functions.
High-temperature/high-humidity test	Subject the object to the environmental conditions of +85°C and 90-95% relative humidity for 96 hours, then expose it to normal temperature/humidity for 24 hours or more. After this test, examine its appearance and functions.
Thermal shock test	Subject the object to cyclic temperature change (-40°C for 30 minutes, then +85°C for 30 minutes) for 5 cycles, then expose to normal temperature/humidity for 24 hours or more.
Sinusoidal vibration test	Subject the object to vibrations of 5 to 200 to 5Hz swept in 10 minutes, 4.5G at maximum (2 mm amplitude), in X and Y directions for two hours each and in Z direction for four hours. After this test, examine its appearance functions.
Vibration test in packaged condition	Subject the object, which is packaged as illustrated, to vibrations of 15 to 60 to 15Hz swept in 6 minutes, 4G at maximum (2mm amplitude at maximum), applied in X, Y and Z directions for two hours each, i.e. six hours in total. After this test, examine its appearance and functions.
Free fall test in packaged condition	Drop the object, which is packaged as illustrated, to a concrete surface from the height of 90 cm, on one corner, three edges and six faces once each, i.e. 10 times in total. After this test, examine its appearance and functions.
Soldering heat resistance test	Soak the lead pins of the unit in solder bath at 270 ± 5 °C for 10 ± 0.5 seconds and then leave for more than 1 hour at 25 ± 5 °C in less than 65% relative humidity. After this test, examine its appearance and functions.
Adhesion test	The device is subjected to be soldered on test PCB. Then apply 0.5 Kg (5 N) of force for 10 ± 1 second in the direction of parallel to the substrate (the soldering should be done by reflow and be conducted with care so that the soldering is uniform and free of defect by stress such as heat shock).

ACR1504I3

Request Samples



Check Inventory



15.0 x 4.0 x 1.2 mm
RoHS/RoHS II Compliant
 MSL Level = N/A

Reflow Profile

Phase	Profile Features	Pb-Free Assembly (SnAgCu)
PREHEAT	-Temperature Min(T_{smin}) -Temperature Max(T_{smax}) -Time(t_s) from (T_{smin} to T_{smax})	150°C 200°C 60-120 seconds
RAMP-UP	Avg. Ramp-up Rate (T_{smax} to T_p)	3°C/second(max)
REFLOW	-Temperature(T_L) -Total Time above T_L (t_L)	217°C 30-100 seconds
PEAK	-Temperature(T_p) -Time(t_p)	260°C 5 second
RAMP-DOWN	Rate	6°C / second max.
Time from 25°C to Peak Temperature		8 minutes max.
Composition of solder paste		96.5Sn/3Ag/0.5Cu
Solder Paste Model		SHENMAO PF606-P26

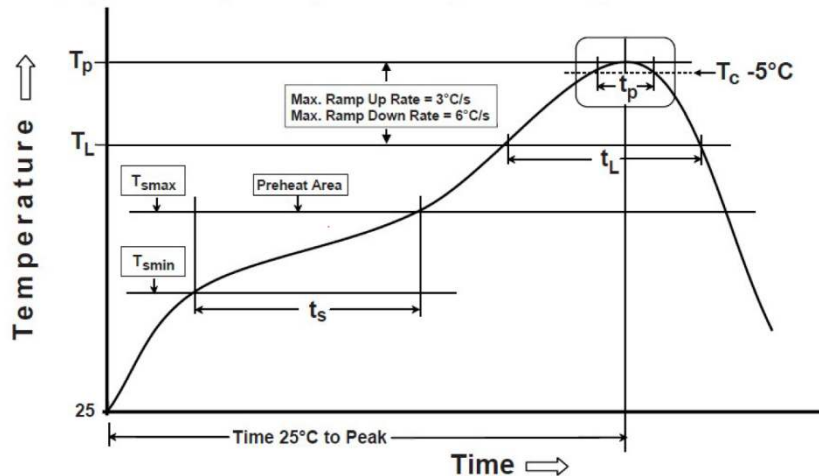

Note : All temperature measurement points are on top/surface of the component. If temperature exceeds the recommended, it will cause surface peeling or damage.

Soldering with Iron :

Soldering iron temperature = 270°C

Apply preheating at 120°C for 2-3 minutes. Finish soldering each terminal within 3 seconds. If soldering iron exceeds a temperature of 270±10°C or a duration of 3 seconds, it will cause surface peeling or damage. (Soldering iron should not leak electricity.)

915/868/433 MHz : LPWA/ISM Multiband Chip Antenna

ABRACON ACR1504I3

ACR1504I3

Request Samples



Check Inventory



15.0 x 4.0 x 1.2 mm
RoHS/RoHS II Compliant
MSL Level = N/A

Caution

1. Ensure to not expose or use the antenna to any corrosive gas including sulfur gas, chlorine gas.
2. Do not solder directly onto the Sn electrode of the chip antenna.

Packaging Information

Blister tape to IEC 286-3, Polymer
Number of pieces in a Tape/Reel : 3000

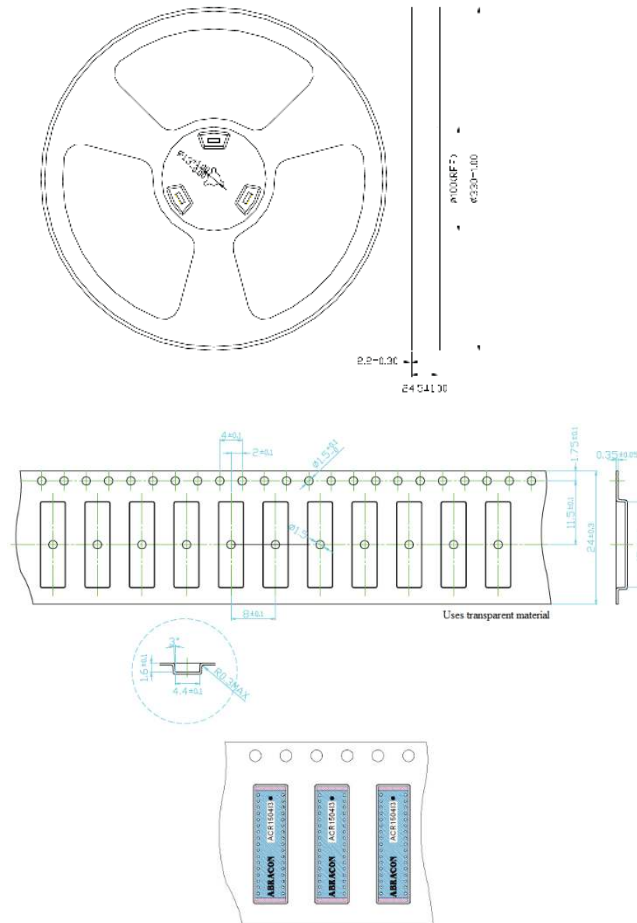

Unit : mm

ATTENTION: Abracon LLC's products are COTS – Commercial-Off-The-Shelf products; suitable for Commercial, Industrial and, where designated, Automotive Applications. Abracon's products are not specifically designed for Military, Aviation, Aerospace, Life-dependent Medical applications or any application requiring high reliability where component failure could result in loss of life and/or property. For applications requiring high reliability and/or presenting an extreme operating environment, written consent and authorization from Abracon LLC is required. Please contact Abracon LLC for more information.



5101 Hidden Creek Ln Spicewood TX 78669
Phone: 512-371-6159 | Fax: 512-351-8858
For terms and conditions of sales, please visit:
www.abracon.com

REVISED: 07-19-21

ABRACON IS
ISO9001-2015
CERTIFIED