

Zener Voltage Regulators

225 mW SOT-23 Surface Mount

MMBZ52xxBLT1G Series, SZMMBZ52xxBLT1G Series

This series of Zener diodes is offered in the convenient, surface mount plastic SOT-23 package. These devices are designed to provide voltage regulation with minimum space requirement. They are well suited for applications such as cellular phones, hand held portables, and high density PC boards.

Features

- 225 mW Rating on FR-4 or FR-5 Board
- Zener Voltage Range – 2.4 V to 91 V
- Package Designed for Optimal Automated Board Assembly
- Small Package Size for High Density Applications
- ESD Rating of Class 3 (> 16 KV) per Human Body Model
- SZ Prefix for Automotive and Other Applications Requiring Unique Site and Control Change Requirements; AEC-Q101 Qualified and PPAP Capable
- These Devices are Pb-Free, Halogen Free/BFR Free and are RoHS Compliant

Mechanical Characteristics

CASE: Void-free, transfer-molded, thermosetting plastic case

FINISH: Corrosion resistant finish, easily solderable

MAXIMUM CASE TEMPERATURE FOR SOLDERING PURPOSES:

260°C for 10 Seconds

POLARITY: Cathode indicated by polarity band

FLAMMABILITY RATING: UL 94 V-0

MAXIMUM RATINGS

Rating	Symbol	Max	Units
Total Power Dissipation on FR-5 Board, (Note 1) @ $T_A = 25^\circ\text{C}$ Derated above 25°C	P_D	225 1.8	mW mW/ $^\circ\text{C}$
Thermal Resistance, Junction-to-Ambient (Note 1)	$R_{\theta JA}$	556	$^\circ\text{C}/\text{W}$
Total Power Dissipation on Alumina Substrate, (Note 2) @ $T_A = 25^\circ\text{C}$ Derated above 25°C	P_D	300 2.4	mW mW/ $^\circ\text{C}$
Thermal Resistance, Junction-to-Ambient (Note 2)	$R_{\theta JA}$	417	$^\circ\text{C}/\text{W}$
Junction and Storage Temperature Range	T_J, T_{stg}	-65 to +150	$^\circ\text{C}$

Stresses exceeding those listed in the Maximum Ratings table may damage the device. If any of these limits are exceeded, device functionality should not be assumed, damage may occur and reliability may be affected.

1. FR-5 = 1.0 X 0.75 X 0.62 in.
2. Alumina = 0.4 X 0.3 X 0.024 in, 99.5% alumina.



ON Semiconductor®

www.onsemi.com

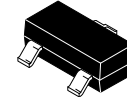

SOT-23
CASE 318
STYLE 8

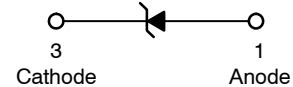

MARKING DIAGRAM

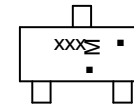

- xxx = Specific Device Code
- M = Date Code
- = Pb-Free Package

(Note: Microdot may be in either location)

ORDERING INFORMATION

Device	Package	Shipping†
MMBZ52xxBLT1G	SOT-23 (Pb-Free)	3,000 / Tape & Reel
SZMMBZ52xxBLT1G	SOT-23 (Pb-Free)	3,000 / Tape & Reel
MMBZ52xxBLT3G	SOT-23 (Pb-Free)	10,000 / Tape & Reel
SZMMBZ52xxBLT3G	SOT-23 (Pb-Free)	10,000 / Tape & Reel

†For information on tape and reel specifications, including part orientation and tape sizes, please refer to our Tape and Reel Packaging Specifications Brochure, BRD8011/D.

DEVICE MARKING INFORMATION

See specific marking information in the device marking column of the Electrical Characteristics table on page 3 of this data sheet.

MMBZ52xxBLT1G Series, SZMMBZ52xxBLT1G Series

ELECTRICAL CHARACTERISTICS

(Pinout: 1-Anode, 2-No Connection, 3-Cathode) ($T_A = 25^\circ\text{C}$ unless otherwise noted, $V_F = 0.95\text{ V Max. @ } I_F = 10\text{ mA}$)

Symbol	Parameter
V_Z	Reverse Zener Voltage @ I_{ZT}
I_{ZT}	Reverse Current
Z_{ZT}	Maximum Zener Impedance @ I_{ZT}
I_{ZK}	Reverse Current
Z_{ZK}	Maximum Zener Impedance @ I_{ZK}
I_R	Reverse Leakage Current @ V_R
V_R	Reverse Voltage
I_F	Forward Current
V_F	Forward Voltage @ I_F

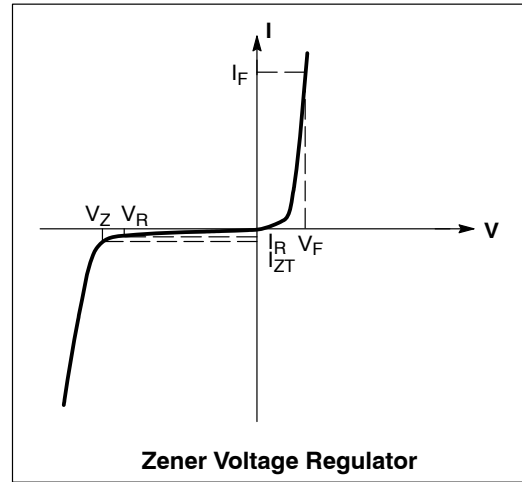

MMBZ52xxBLT1G Series, SZMMBZ52xxBLT1G Series

ELECTRICAL CHARACTERISTICS (Pinout: 1-Anode, 2-NC, 3-Cathode) ($V_F = 0.9\text{ V Max @ }I_F = 10\text{ mA}$ for all types.)

Device*	Device Marking	Zener Voltage (Note 3)			Zener Impedance			Leakage Current		
		V _Z (Volts)			@ I _{ZT}	Z _{ZT} @ I _{ZT}	Z _{ZK} @ I _{ZK}		I _R @ V _R	
		Min	Nom	Max	mA	Ω	Ω	mA	μA	Volts
MMBZ5221BLT1G	18A	2.28	2.4	2.52	20	30	1200	0.25	100	1
MMBZ5222BLT1G	18B	2.37	2.5	2.63	20	30	1250	0.25	100	1
MMBZ5223BLT1G	18C	2.56	2.7	2.84	20	30	1300	0.25	75	1
MMBZ5224BLT1G	18D	2.66	2.8	2.94	20	30	1400	0.25	75	1
MMBZ5225BLT1G	18E	2.85	3	3.15	20	29	1600	0.25	50	1
MMBZ5226BLT1G	8A	3.13	3.3	3.47	20	28	1600	0.25	25	1
MMBZ5227BLT1G	8B	3.42	3.6	3.78	20	24	1700	0.25	15	1
MMBZ5228BLT1G	8C	3.70	3.9	4.10	20	23	1900	0.25	10	1
MMBZ5229BLT1G	8D	4.08	4.3	4.52	20	22	2000	0.25	5	1
MMBZ5230BLT1G	8E	4.46	4.7	4.94	20	19	1900	0.25	5	2
MMBZ5231BLT1G/T3G	8F	4.84	5.1	5.36	20	17	1600	0.25	5	2
MMBZ5232BLT1G/T3G	8G	5.32	5.6	5.88	20	11	1600	0.25	5	3
MMBZ5233BLT1G	8H	5.70	6	6.30	20	7	1600	0.25	5	3.5
MMBZ5234BLT1G/T3G	8J	5.89	6.2	6.51	20	7	1000	0.25	5	4
MMBZ5235BLT1G	8K	6.46	6.8	7.14	20	5	750	0.25	3	5
MMBZ5236BLT1G	8L	7.12	7.5	7.88	20	6	500	0.25	3	6
MMBZ5237BLT1G	8M	7.79	8.2	8.61	20	8	500	0.25	3	6.5
MMBZ5238BLT1G	8N	8.26	8.7	9.14	20	8	600	0.25	3	6.5
MMBZ5239BLT1G	8P	8.64	9.1	9.56	20	10	600	0.25	3	7
MMBZ5240BLT1G	8Q	9.50	10	10.50	20	17	600	0.25	3	8
MMBZ5241BLT1G/T3G	8R	10.4	11	11.55	20	22	600	0.25	2	8.4
MMBZ5242BLT1G/T3G	8S	11.40	12	12.60	20	30	600	0.25	1	9.1
MMBZ5243BLT1G	8T	12.35	13	13.65	9.5	13	600	0.25	0.5	9.9
MMBZ5244BLT1G	8U	13.30	14	14.70	9	15	600	0.25	0.1	10
MMBZ5245BLT1G	8V	14.25	15	15.75	8.5	16	600	0.25	0.1	11
MMBZ5246BLT1G	8W	15.20	16	16.80	7.8	17	600	0.25	0.1	12
MMBZ5247BLT1G/T3G	8X	16.15	17	17.85	7.4	19	600	0.25	0.1	13
MMBZ5248BLT1G/T3G	8Y	17.10	18	18.90	7	21	600	0.25	0.1	14
MMBZ5249BLT1G	8Z	18.05	19	19.95	6.6	23	600	0.25	0.1	14
MMBZ5250BLT1G/T3G	81A	19.00	20	21.00	6.2	25	600	0.25	0.1	15
MMBZ5251BLT1G	81B	20.90	22	23.10	5.6	29	600	0.25	0.1	17
MMBZ5252BLT1G	81C	22.80	24	25.20	5.2	33	600	0.25	0.1	18
MMBZ5253BLT1G	81D	23.75	25	26.25	5	35	600	0.25	0.1	19
MMBZ5254BLT1G	81E	25.65	27	28.35	4.6	41	600	0.25	0.1	21
MMBZ5255BLT1G	81F	26.60	28	29.40	4.5	44	600	0.25	0.1	21
MMBZ5256BLT1G	81G	28.50	30	31.50	4.2	49	600	0.25	0.1	23
MMBZ5257BLT1G/T3G	81H	31.35	33	34.65	3.8	58	700	0.25	0.1	25
MMBZ5258BLT1G	81J	34.20	36	37.80	3.4	70	700	0.25	0.1	27
MMBZ5259BLT1G	81K	37.05	39	40.95	3.2	80	800	0.25	0.1	30
MMBZ5260BLT1G	81L	40.85	43	45.15	3	93	900	0.25	0.1	33
MMBZ5261BLT1G/T3G	81M	44.65	47	49.35	2.7	105	1000	0.25	0.1	36
MMBZ5262BLT1G	81N	48.45	51	53.55	2.5	125	1100	0.25	0.1	39
MMBZ5263BLT1G	81P	53.20	56	58.80	2.2	150	1300	0.25	0.1	43
MMBZ5264BLT1G	81Q	57.00	60	63.00	2.1	170	1400	0.25	0.1	46
MMBZ5265BLT1G	81R	58.90	62	65.10	2	185	1400	0.25	0.1	47
MMBZ5266BLT1G	81S	64.60	68	71.40	1.8	230	1600	0.25	0.1	52
MMBZ5267BLT1G	81T	71.25	75	78.75	1.7	270	1700	0.25	0.1	56
MMBZ5268BLT1G	81U	77.90	82	86.10	1.5	330	2000	0.25	0.1	62
MMBZ5270BLT1G	81W	86.45	91	95.55	1.4	400	2300	0.25	0.1	69

Product parametric performance is indicated in the Electrical Characteristics for the listed test conditions, unless otherwise noted. Product performance may not be indicated by the Electrical Characteristics if operated under different conditions.

3. Zener voltage is measured with a pulse test current I_Z at an ambient temperature of 25°C

NOTE: MMBZ5233BLT1G, MMBZ5246BLT1G, MMBZ5251BLT1G, and MMBZ5252BLT1G Not Available in 10,000/Tape & Reel.

*Include SZ-prefix devices where applicable.

MMBZ52xxBLT1G Series, SZMMBZ52xxBLT1G Series

TYPICAL CHARACTERISTICS

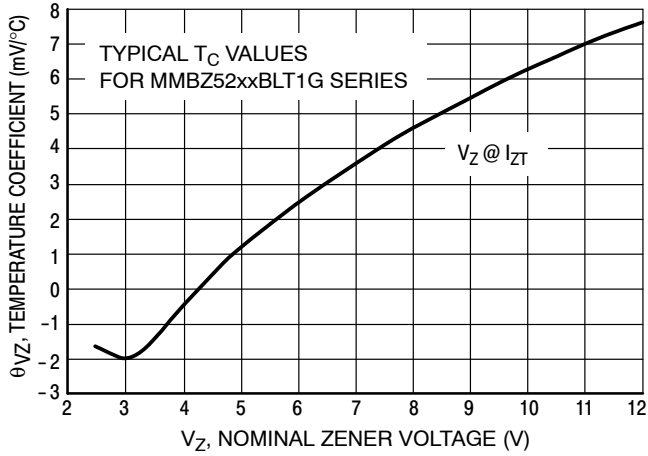

Figure 1. Temperature Coefficients
(Temperature Range -55°C to +150°C)

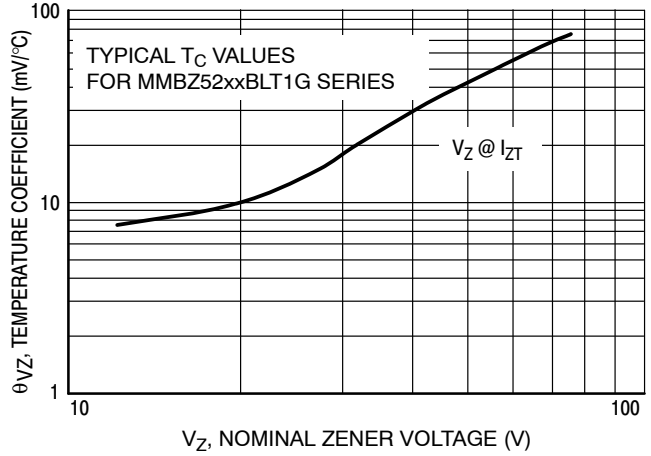

Figure 2. Temperature Coefficients
(Temperature Range -55°C to +150°C)

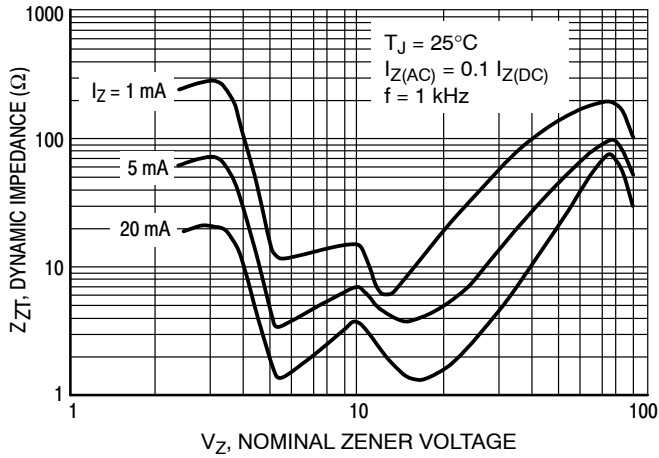

Figure 3. Effect of Zener Voltage on Zener Impedance

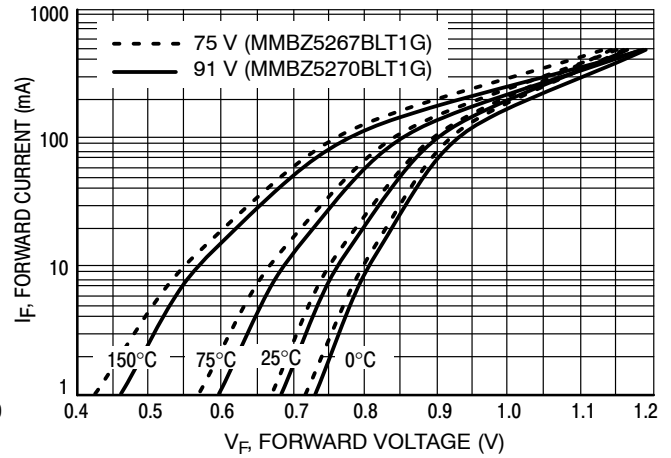

Figure 4. Typical Forward Voltage

MMBZ52xxBLT1G Series, SZMMBZ52xxBLT1G Series

TYPICAL CHARACTERISTICS

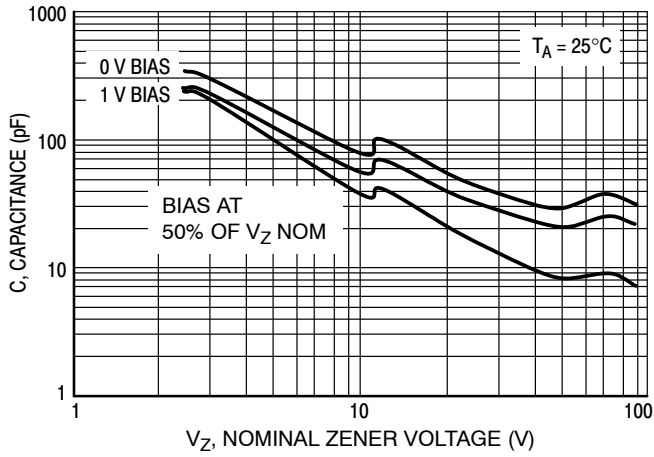

Figure 5. Typical Capacitance

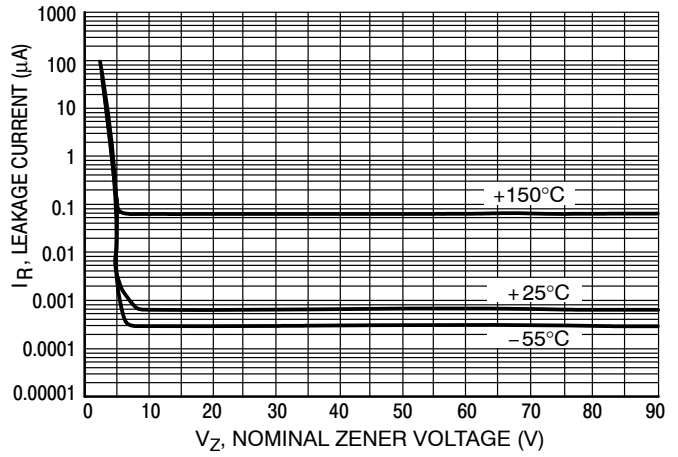

Figure 6. Typical Leakage Current

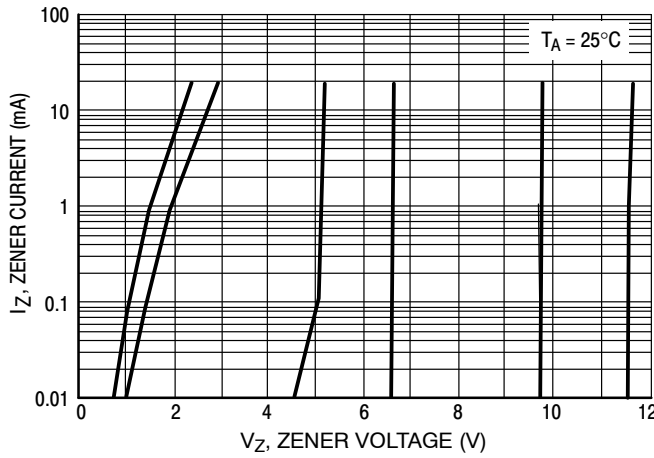

Figure 7. Zener Voltage versus Zener Current (V_Z Up to 12 V)

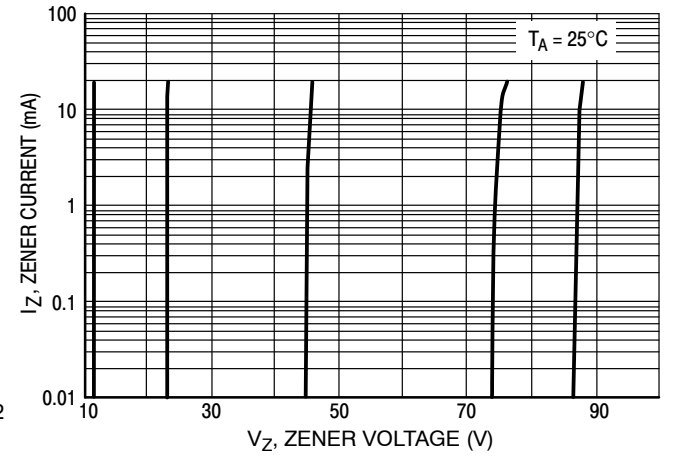
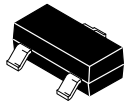

Figure 8. Zener Voltage versus Zener Current (12 V to 91 V)

MECHANICAL CASE OUTLINE PACKAGE DIMENSIONS



SOT-23 (TO-236)
CASE 318
ISSUE AT

DATE 01 MAR 2023

SCALE 4:1

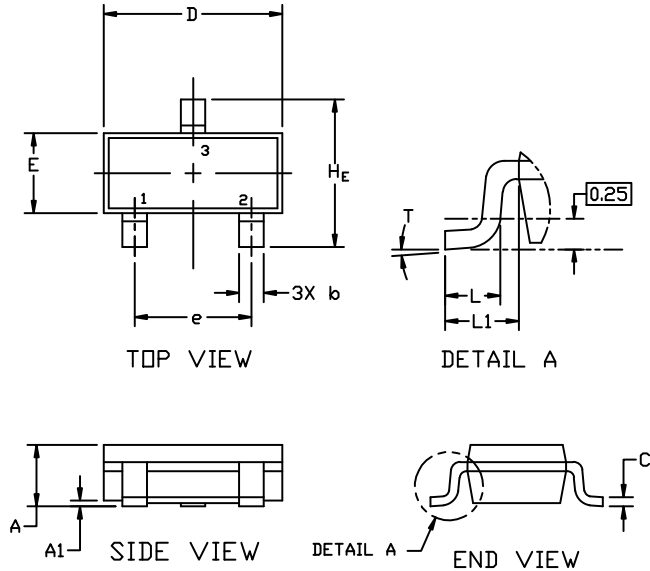

NOTES:

1. DIMENSIONING AND TOLERANCING PER ASME Y14.5M,1994.
2. CONTROLLING DIMENSION: MILLIMETERS
3. MAXIMUM LEAD THICKNESS INCLUDES LEAD FINISH. MINIMUM LEAD THICKNESS IS THE MINIMUM THICKNESS OF THE BASE MATERIAL.
4. DIMENSIONS D AND E DO NOT INCLUDE MOLD FLASH, PROTRUSIONS, OR GATE BURRS.

DIM	MILLIMETERS			INCHES		
	MIN.	NOM.	MAX.	MIN.	NOM.	MAX.
A	0.89	1.00	1.11	0.035	0.039	0.044
A1	0.01	0.06	0.10	0.000	0.002	0.004
b	0.37	0.44	0.50	0.015	0.017	0.020
c	0.08	0.14	0.20	0.003	0.006	0.008
D	2.80	2.90	3.04	0.110	0.114	0.120
E	1.20	1.30	1.40	0.047	0.051	0.055
e	1.78	1.90	2.04	0.070	0.075	0.080
L	0.30	0.43	0.55	0.012	0.017	0.022
L1	0.35	0.54	0.69	0.014	0.021	0.027
H _E	2.10	2.40	2.64	0.083	0.094	0.104
T	0°	---	10°	0°	---	10°

GENERIC MARKING DIAGRAM*



- XXX = Specific Device Code
- M = Date Code
- = Pb-Free Package

*This information is generic. Please refer to device data sheet for actual part marking. Pb-Free indicator, "G" or microdot "▪", may or may not be present. Some products may not follow the Generic Marking.

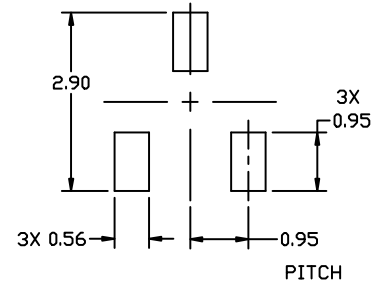

RECOMMENDED MOUNTING FOOTPRINT

* For additional information on our Pb-Free strategy and soldering details, please download the ON Semiconductor Soldering and Mounting Techniques Reference Manual, SOLDERRM/D.

STYLES ON PAGE 2

DOCUMENT NUMBER:	98ASB42226B	Electronic versions are uncontrolled except when accessed directly from the Document Repository. Printed versions are uncontrolled except when stamped "CONTROLLED COPY" in red.
DESCRIPTION:	SOT-23 (TO-236)	PAGE 1 OF 2

onsemi and ONSEMI are trademarks of Semiconductor Components Industries, LLC dba onsemi or its subsidiaries in the United States and/or other countries. onsemi reserves the right to make changes without further notice to any products herein. onsemi makes no warranty, representation or guarantee regarding the suitability of its products for any particular purpose, nor does onsemi assume any liability arising out of the application or use of any product or circuit, and specifically disclaims any and all liability, including without limitation special, consequential or incidental damages. onsemi does not convey any license under its patent rights nor the rights of others.

MECHANICAL CASE OUTLINE
PACKAGE DIMENSIONS



SOT-23 (TO-236)
CASE 318
ISSUE AT

DATE 01 MAR 2023

- | | | | | | |
|---|---|---|---|---|---|
| STYLE 1 THRU 5:
CANCELLED | STYLE 6:
PIN 1. BASE
2. EMITTER
3. COLLECTOR | STYLE 7:
PIN 1. EMITTER
2. BASE
3. COLLECTOR | STYLE 8:
PIN 1. ANODE
2. NO CONNECTION
3. CATHODE | | |
| STYLE 9:
PIN 1. ANODE
2. ANODE
3. CATHODE | STYLE 10:
PIN 1. DRAIN
2. SOURCE
3. GATE | STYLE 11:
PIN 1. ANODE
2. CATHODE
3. CATHODE-ANODE | STYLE 12:
PIN 1. CATHODE
2. CATHODE
3. ANODE | STYLE 13:
PIN 1. SOURCE
2. DRAIN
3. GATE | STYLE 14:
PIN 1. CATHODE
2. GATE
3. ANODE |
| STYLE 15:
PIN 1. GATE
2. CATHODE
3. ANODE | STYLE 16:
PIN 1. ANODE
2. CATHODE
3. CATHODE | STYLE 17:
PIN 1. NO CONNECTION
2. ANODE
3. CATHODE | STYLE 18:
PIN 1. NO CONNECTION
2. CATHODE
3. ANODE | STYLE 19:
PIN 1. CATHODE
2. ANODE
3. CATHODE-ANODE | STYLE 20:
PIN 1. CATHODE
2. ANODE
3. GATE |
| STYLE 21:
PIN 1. GATE
2. SOURCE
3. DRAIN | STYLE 22:
PIN 1. RETURN
2. OUTPUT
3. INPUT | STYLE 23:
PIN 1. ANODE
2. ANODE
3. CATHODE | STYLE 24:
PIN 1. GATE
2. DRAIN
3. SOURCE | STYLE 25:
PIN 1. ANODE
2. CATHODE
3. GATE | STYLE 26:
PIN 1. CATHODE
2. ANODE
3. NO CONNECTION |
| STYLE 27:
PIN 1. CATHODE
2. CATHODE
3. CATHODE | STYLE 28:
PIN 1. ANODE
2. ANODE
3. ANODE | | | | |

DOCUMENT NUMBER:	98ASB42226B	Electronic versions are uncontrolled except when accessed directly from the Document Repository. Printed versions are uncontrolled except when stamped "CONTROLLED COPY" in red.
DESCRIPTION:	SOT-23 (TO-236)	PAGE 2 OF 2

onsemi and **ONSEMI** are trademarks of Semiconductor Components Industries, LLC dba **onsemi** or its subsidiaries in the United States and/or other countries. **onsemi** reserves the right to make changes without further notice to any products herein. **onsemi** makes no warranty, representation or guarantee regarding the suitability of its products for any particular purpose, nor does **onsemi** assume any liability arising out of the application or use of any product or circuit, and specifically disclaims any and all liability, including without limitation special, consequential or incidental damages. **onsemi** does not convey any license under its patent rights nor the rights of others.

onsemi, **Onsemi**, and other names, marks, and brands are registered and/or common law trademarks of Semiconductor Components Industries, LLC dba "**onsemi**" or its affiliates and/or subsidiaries in the United States and/or other countries. **onsemi** owns the rights to a number of patents, trademarks, copyrights, trade secrets, and other intellectual property. A listing of **onsemi**'s product/patent coverage may be accessed at www.onsemi.com/site/pdf/Patent-Marking.pdf. **onsemi** reserves the right to make changes at any time to any products or information herein, without notice. The information herein is provided "as-is" and **onsemi** makes no warranty, representation or guarantee regarding the accuracy of the information, product features, availability, functionality, or suitability of its products for any particular purpose, nor does **onsemi** assume any liability arising out of the application or use of any product or circuit, and specifically disclaims any and all liability, including without limitation special, consequential or incidental damages. Buyer is responsible for its products and applications using **onsemi** products, including compliance with all laws, regulations and safety requirements or standards, regardless of any support or applications information provided by **onsemi**. "Typical" parameters which may be provided in **onsemi** data sheets and/or specifications can and do vary in different applications and actual performance may vary over time. All operating parameters, including "Typicals" must be validated for each customer application by customer's technical experts. **onsemi** does not convey any license under any of its intellectual property rights nor the rights of others. **onsemi** products are not designed, intended, or authorized for use as a critical component in life support systems or any FDA Class 3 medical devices or medical devices with a same or similar classification in a foreign jurisdiction or any devices intended for implantation in the human body. Should Buyer purchase or use **onsemi** products for any such unintended or unauthorized application, Buyer shall indemnify and hold **onsemi** and its officers, employees, subsidiaries, affiliates, and distributors harmless against all claims, costs, damages, and expenses, and reasonable attorney fees arising out of, directly or indirectly, any claim of personal injury or death associated with such unintended or unauthorized use, even if such claim alleges that **onsemi** was negligent regarding the design or manufacture of the part. **onsemi** is an Equal Opportunity/Affirmative Action Employer. This literature is subject to all applicable copyright laws and is not for resale in any manner.

ADDITIONAL INFORMATION

TECHNICAL PUBLICATIONS:

Technical Library: www.onsemi.com/design/resources/technical-documentation
onsemi Website: www.onsemi.com

ONLINE SUPPORT: www.onsemi.com/support

For additional information, please contact your local Sales Representative at www.onsemi.com/support/sales