

## MHS 5/06 W T3 B T

**Weidmüller Interface GmbH & Co. KG**

Klingenbergstraße 26

D-32758 Detmold

Germany

www.weidmueller.com

### Product image



### OMNIMATE® 4.0 - the next evolution step

OMNIMATE® 4.0 follows the trend of One Cable Technology (OCT). The modular concept enables the fast configuration of hybrid interfaces, which transmit data, signals and energy in a single connector. As a result, you can reduce the cabling effort in a wide variety of applications, simplify maintenance and accelerate automation processes. The unique SNAP IN connection is the backbone and speeds up the wiring process.

### The fastest connection yet

- Fast, safe, and tool-free wiring due to unique SNAP IN connection
- Ready for Robot through "wire ready" delivery with open clamping point
- Optical and acoustic feedback indicates proper wiring

### Create your own configuration

- Flexible configuration and ordering via the Weidmüller Configurator (WMC)
- Dispatch within three days – even for individually configured products
- Automatic offer preparation for the configured product

### Simply configuration of modular hybrid connectors

- Flexible combination options for power, signal and data transmission
- Future-proof Single-Pair Ethernet technology

### General ordering data

|              |   |
|--------------|---|
| Version      | PCB plug-in connector, male header, THT/THR solder connection, Pitch in mm (P): 5.00 mm, Number of poles: 6, 270°, Tube |
| Order No.    | <a href="#">8000072509</a>  |
| Type         | MHS 5/06 W T3 B T   |
| GTIN (EAN)   | 4064675330905   |
| Qty.         | 17 pc(s).   |
| Product data | IEC: 400 V / 26.8 A<br>UL: 300 V / 18.5 A   |
| Packaging    | Tube  |

Creation date August 24, 2023 11:04:35 AM CEST

## MHS 5/06 W T3 B T

Weidmüller Interface GmbH &amp; Co. KG

Klingenbergstraße 26

D-32758 Detmold

Germany

www.weidmueller.com

## Technical data

## Dimensions and weights

|                          |            |                 |            |
|--------------------------|------------|-----------------|------------|
| Depth                    | 14 mm      | Depth (inches)  | 0.551 inch |
| Height                   | 14.1 mm    | Height (inches) | 0.555 inch |
| Height of lowest version | 10.9 mm    | Width           | 31.38 mm   |
| Width (inches)           | 1.235 inch | Net weight      | 4.6 g      |

## Temperatures

|                             |        |                             |        |
|-----------------------------|--------|-----------------------------|--------|
| Operating temperature, min. | -50 °C | Operating temperature, max. | 100 °C |
|-----------------------------|--------|-----------------------------|--------|

## System specifications

|  |  |  |                  |
|--|--|--|------------------|
| Product family                               | OMNIMATE 4.0                               | Type of connection                         | Board connection |
| Mounting onto the PCB                        | THT/THR solder connection                  | Pitch in mm (P)                            | 5 mm             |
| Pitch in inches (P)                          | 0.197 inch                                 | Outgoing elbow                             | 270°             |
| Number of poles                              | 6  | Number of solder pins per pole             | 1                |
| Solder pin length (l)                        | 3.2 mm                                     | Solder pin dimensions                      | 1.0 x 1.0 mm     |
| Solder eyelet hole diameter (D)              | 1.4 mm                                     | Solder eyelet hole diameter tolerance (D)+ | 0, 1 mm          |
| Outside diameter of solder pad               | 2.3 mm                                     | Template aperture diameter                 | 2.1 mm           |
| L1 in mm                                     | 25 mm                                      | L1 in inches                               | 0.984 inch       |
| Number of rows                               | 1  | Pin series quantity                        | 1                |
| Touch-safe protection acc. to DIN VDE 57 106 | Touch-safe above the printed circuit board | Touch-safe protection acc. to DIN VDE 0470 | IP 20            |
| Protection degree                            | IP20                                       | Volume resistance                          | ≤5 mΩ            |
| Plugging cycles                              | ≥ 25                                       | Plugging force/pole, max.                  | 8.5 N            |
| Pulling force/pole, max.                     | 8.5 N                                      |  |                  |

## Material data

|                                  |          |                             |        |
|----------------------------------|----------|-----------------------------|--------|
| Insulating material              | PA 9T    | Colour                      | black  |
| Colour chart (similar)           | RAL 9011 | Insulating material group   | I      |
| Comparative Tracking Index (CTI) | ≥ 600    | Moisture Level (MSL)        | 1      |
| UL 94 flammability rating        | V-0      | Contact base material       | CuMg   |
| Contact material                 | CuMg     | Contact surface             | tinned |
| Tinning type                     | matt     | Storage temperature, min.   | -25 °C |
| Storage temperature, max.        | 55 °C    | Operating temperature, min. | -50 °C |
| Operating temperature, max.      | 100 °C   |                             |        |

## Rated data acc. to IEC

|   |                        |   |        |
|---|------------------------|---|--------|
| tested acc. to standard   | IEC 60664-1, IEC 61984 | Rated current, min. number of poles (Tu=20°C)                         | 26.8 A |
| Rated current, max. number of poles (Tu=20°C)                             | 19.7 A                 | Rated current, min. number of poles (Tu=40°C)                         | 23.1 A |
| Rated current, max. number of poles (Tu=40°C)                             | 16.9 A                 | Rated voltage for surge voltage class / pollution degree II/2         | 400 V  |
| Rated voltage for surge voltage class / pollution degree III/2            | 320 V                  | Rated voltage for surge voltage class / pollution degree III/3        | 250 V  |
| Rated impulse voltage for surge voltage class/ pollution degree II/2      | 4 kV                   | Rated impulse voltage for surge voltage class/ pollution degree III/2 | 4 kV   |
| Rated impulse voltage for surge voltage class/ contamination degree III/3 | 4 kV                   | Clearance, min.   | 4 mm   |
| Creepage distance, min.   | 5.4 mm                 |   |        |

## MHS 5/06 W T3 B T

Weidmüller Interface GmbH &amp; Co. KG

Klingenbergstraße 26

D-32758 Detmold

Germany

www.weidmueller.com

## Technical data

## Rated data acc. to UL 1059

Institute (cURus)



Certificate No. (cURus)

E60693

Rated voltage (Use group B / UL 1059) 300 V

Rated voltage (Use group D / UL 1059) 300 V

Rated voltage (Use group F / UL 1059) 420 V

Rated current (Use group B / UL 1059) 18.5 A

Rated current (Use group D / UL 1059) 10 A

Clearance distance, min. 4 mm

Creepage distance, min.

Reference to approval values

Specifications are maximum values, details - see approval certificate.

5.6 mm

## Classifications

|             |             |             |             |
|-------------|-------------|-------------|-------------|
| ETIM 6.0    | EC002637    | ETIM 7.0    | EC002637    |
| ETIM 8.0    | EC002637    | ECLASS 9.0  | 27-44-04-02 |
| ECLASS 9.1  | 27-44-04-02 | ECLASS 10.0 | 27-44-04-02 |
| ECLASS 11.0 | 27-46-02-01 | ECLASS 12.0 | 27-46-02-01 |

## Important note

IPC conformity

Conformity: The products are developed, manufactured and delivered according international recognized standards and norms and comply with the assured properties in the data sheet resp. fulfill decorative properties in accordance with IPC-A-610 "Class 2". Further claims on the products can be evaluated on request.

Notes

- Rated current related to rated cross-section & min. No. of poles.
- P on drawing = pitch
- Rated data refer only to the component itself. Clearance and creepage distances to other components are to be designed in accordance with the relevant application standards.
- Diameter of solder eyelet D = 1.4+0.1mm
- Long term storage of the product with average temperature of 50 °C and average humidity 70%, 36 months

## Approvals

Approvals



UL File Number Search

UL Website

Certificate No. (cURus)

E60693

## Downloads

Approval/Certificate/Document of Conformity

[Declaration of the Manufacturer](#)

Engineering Data

[CAD data – STEP](#)

Catalogues

[Catalogues in PDF-format](#)

**Data sheet**

**MHS 5/06 W T3 B T**

**Weidmüller Interface GmbH & Co. KG**  
 Klingenbergstraße 26  
 D-32758 Detmold  
 Germany

[www.weidmueller.com](http://www.weidmueller.com)

**Drawings**

**Product image**



**Dimensional drawing**

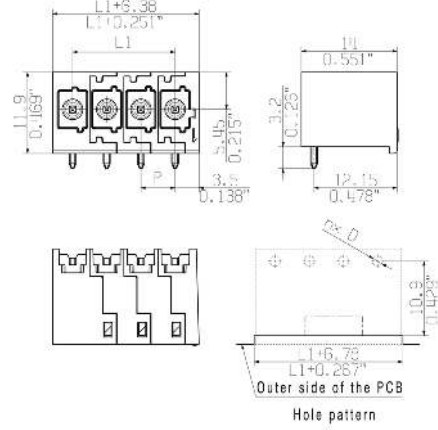

Allgemeinguetlige Kundenzeichnung, aktueller Stand nur auf Anfrage  
 General customer drawing, topical version only if required

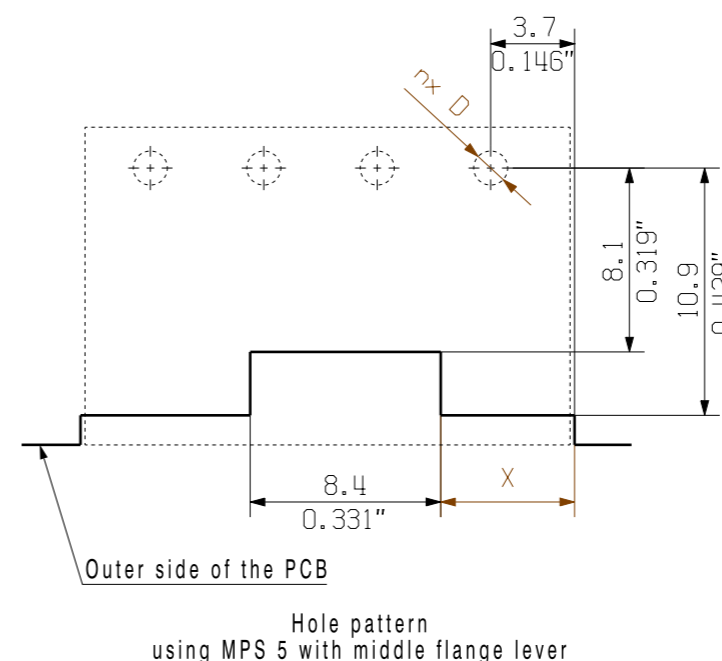
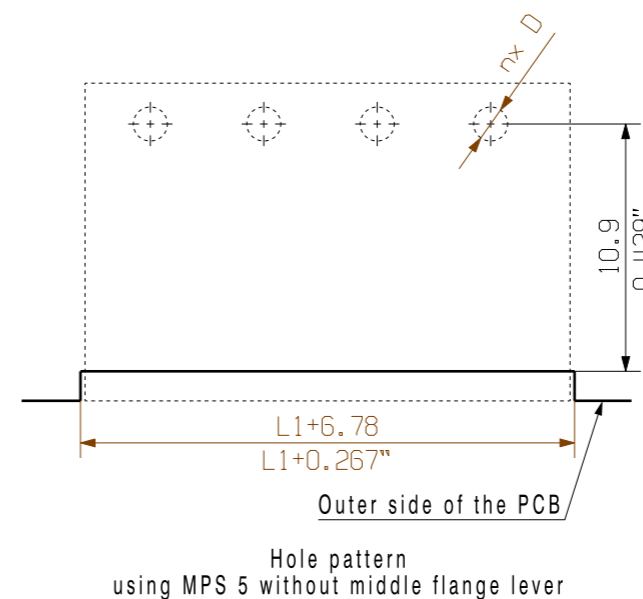
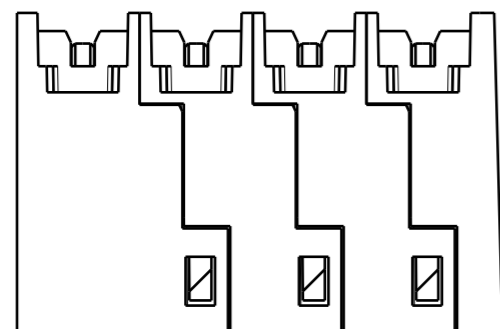
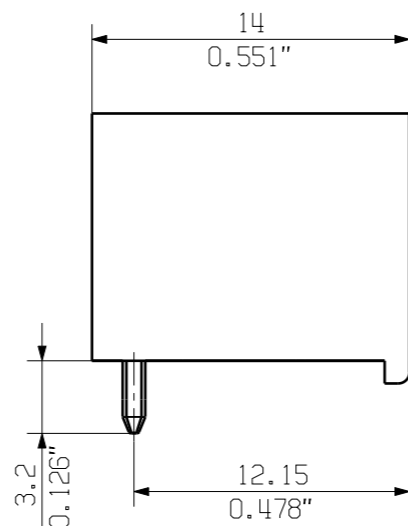
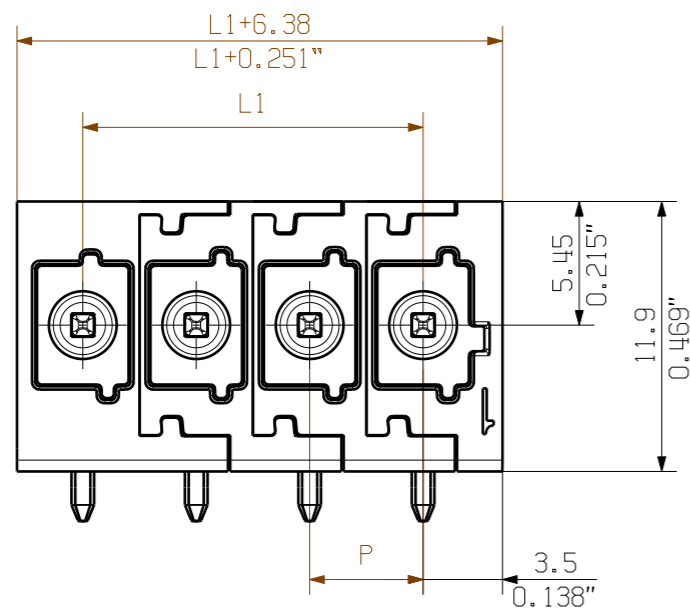

|         |         |           |        |          |
|---------|---------|-----------|--------|----------|
| 12      | 55.00   | 2.165     | 25.40  | 1.000    |
| 11      | 50.00   | 1.969     | 25.40  | 1.000    |
| 10      | 45.00   | 1.772     | 20.40  | 0.803    |
| 9       | 40.00   | 1.575     | 20.40  | 0.803    |
| 8       | 35.00   | 1.378     | 15.40  | 0.606    |
| 7       | 30.00   | 1.181     | 15.40  | 0.606    |
| 6       | 25.00   | 0.984     | 10.40  | 0.409    |
| 5       | 20.00   | 0.787     | 10.40  | 0.409    |
| 4       | 15.00   | 0.591     | 5.40   | 0.213    |
| 3       | 10.00   | 0.394     | 5.40   | 0.213    |
| 2       | 5.00    | 0.197     | 0.40   | 0.016    |
| n Poles | L1 [mm] | L1 [inch] | X [mm] | X [inch] |

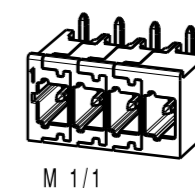

Further Dim. & Info. See data sheet

General tolerance:  
 DIN ISO 2768-mK

For the mounting of PCBs, it should be noted that the rated data relates only to the PCB components alone.  
 The necessary creepage and clearance paths must be observed in connection with the respective applicant in accordance to IEC 664 / VDE 0110.  
 The current-carrying capacity and pitch tolerance is to be determined according to DIN IEC 326 part 3 very fine.

Weidmüller PCB components are tested according to the DIN EN 61984 or to the DIN EN 60947-7-4 standard, and are valid for its field of application.  
 Provided that the components are used to the intended purpose, all requirements with respect to the occurring of electrical, mechanical, thermic and corrosive stress will be satisfied.

|                   |                                |  |  |
|-------------------|--------------------------------|--|--|
|                   | EC00008107<br>P038108          | Prim PLM Part No.:   | Prim ERP Part No.:                                     |
|                   | First Issue Date<br>27.01.2021 | Max. nos.  | 73985  |
|                   |                                | Drawing no. <b>73985</b> Issue no. <b>2</b><br>Sheet 2 of 2 sheets |  |
|                   | Date                           | Name   | <b>MHS 5/... W T3 ...</b><br>STIFTLISTE<br>MALE HEADER |
| Drawn             | 28.06.2021                     | Reger, Marc  |  |
| Responsible       |                                | Stuckmann, Peter   |  |
| Scale: ./.        | Size: A3                       | Approved   | 29.09.2022   |
| Drawings Assembly |                                | Product file:  |  |

## Recommended wave soldering profiles

**Weidmüller Interface GmbH & Co. KG**  
 Klängenbergstraße 16  
 D-32758 Detmold  
 Germany  
 Fon: +49 5231 14-0  
 Fax: +49 5231 14-292083  
 www.weidmueller.com

### Single Wave:



### Double Wave:

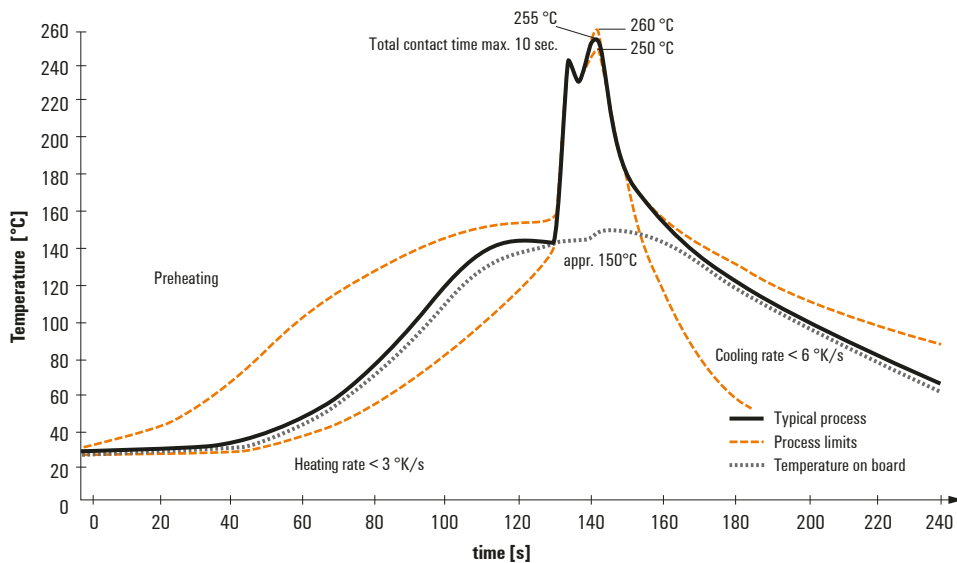

### Wave soldering profiles

Wired connection elements should be processed in accordance with the DIN EN 61760-1 standard. We have included two recommendations for practical wave soldering profiles, with which Weidmüller PCB terminals and connectors are qualified.

When choosing a suitable profile for your application, the following factors also need to be considered:

- PCB thickness
- Proportion of Cu in the layers
- Single/double-sided assembly
- Product range
- Heating and cooling rates

The single and double wave profiles each indicate the recommended operating range, including the maximum soldering temperature of 260°C. In practice, the maximum soldering temperature is quite often well below the above maximum profile.

## Recommended reflow soldering profile

**Weidmüller Interface GmbH & Co. KG**  
 Klingenbergstraße 16  
 D-32758 Detmold  
 Germany  
 Fon: +49 5231 14-0  
 Fax: +49 5231 14-292083  
 www.weidmueller.com

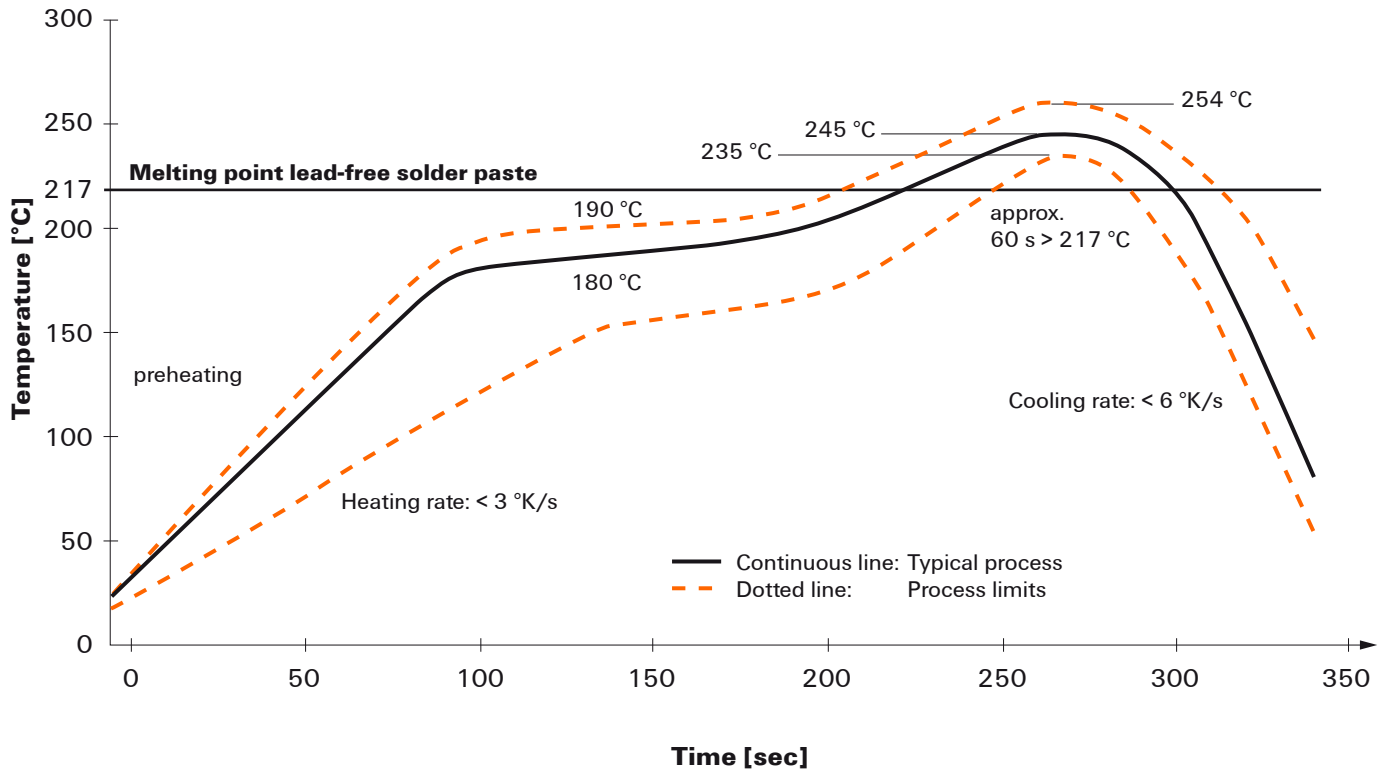

### Reflow soldering profile

The perfect soldering profile for SMT Surface Mount Technology is one the most exiting question in SMT production. But there are more than one correct answer: The diagram of temperature-on-time is related to processing features of solder paste and to maximum load of components.

We have to consider the following parameters:

- Time for pre heating
- Maximum temperature
- Time above melting point
- Time for cooling
- Maximum heating rate
- Maximum cooling rate

We recommend a typical solder profile with associated process limits. With preheating components and board are prepared smoothly for the solder phase. Heating rate is typically  $\leq +3\text{K/s}$ . In parallel the solder paste is ‚activated‘. The time above melting point of  $217^\circ\text{C}$  the paste gets liquid and components and boards begin to connect. The maximum temperature of  $245^\circ\text{C}$  to  $254^\circ\text{C}$  should stay between 10 and 40 seconds. In the cooling phase at  $\geq -6\text{K/s}$  solder is cured. Board and components cool down while avoiding cold cracks.