

SPECIFICATION

CSB63CA2G2C

PACKAGE OUTLINES

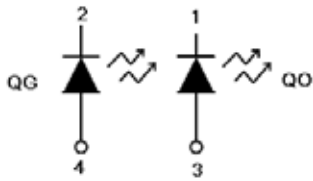
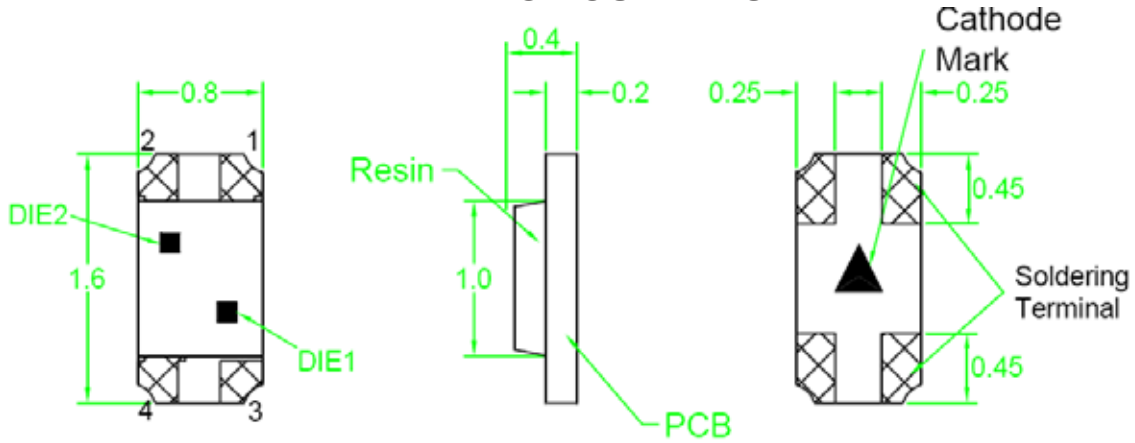

RECOMMEND PAD LAYOUT

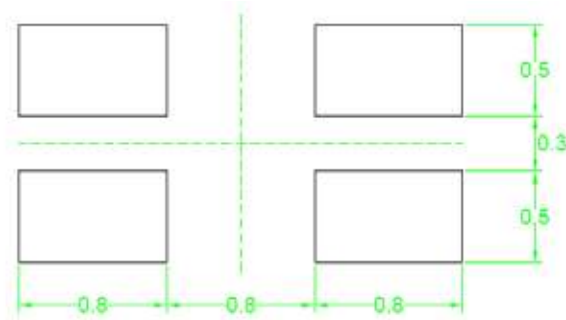

Notes:

1. All dimensions are in millimeters (inches).
2. Tolerance is $\pm 0.25\text{mm}$ (0.01") unless otherwise noted.
3. Specifications are subject to change without notice.

Part Number	Chip Material	Color of Emission	Lens Type	Viewing Angle
CSB63CA2G2C	InGaAlP	Orange	Water Clear	120°
	InGaAlP	Green	Water Clear	120°



ChromeLED Corp. reserves the right to make changes at any time in order to supply the best product possible. The most current version of this document will always be available at: www.chromeled.com

ABSOLUTE MAXIMUM RATINGS
(TA=25°C)

Parameter	Symbol	Max Rating	Unit
Forward Current	I _F	30	mA
Reverse Current @ 5V	I _R	10	μA
Power Dissipation	P _d	78	mW
Operating Temperature Range	T _{OP}	-40~+85	°C
Storage Temperature Range	T _{STG}	-40~+90	°C
Peak Pulsing Current (1/10 duty f = 10KHz)	I _{FP}	60	mA
Soldering Temperature	T _{SOL}	Max 260°C for 5 sec Max	

OPTICAL-ELECTRICAL CHARACTERISTICS
(TA=25°C)

Parameter	Symbol	Test Condition	Color	Value			Unit
				Min	Typ	Max	
Luminous Intensity	I _v	I _F = 20mA	G	30	60	-	mcd
			O	80	220		
Forward Voltage	V _F	I _F = 20mA	G	1.7	2.2	2.6	V
			O	1.7	2.2	2.4	
Viewing Angle at 50% I _v	2θ _{1/2}	I _F = 20mA	-	-	120	-	Deg
Peak Wavelength	λ _P	I _F = 20mA	G	-	575	-	nm
			O		610		
Dominant Wavelength	λ _D	I _F = 20mA	G	-	574	-	nm
			O		605		

*Tolerance of viewing angle: -10 / +5 deg.



ChromeLED Corp. reserves the right to make changes at any time in order to supply the best product possible. The most current version of this document will always be available at: www.chromeled.com

OPTICAL CHARACTERISTIC CURVES - GREEN

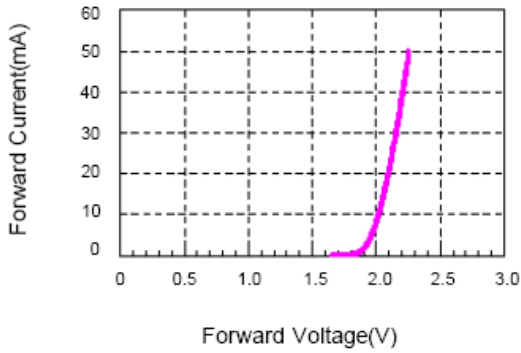

Fig.3 Forward Voltage vs. Temperature

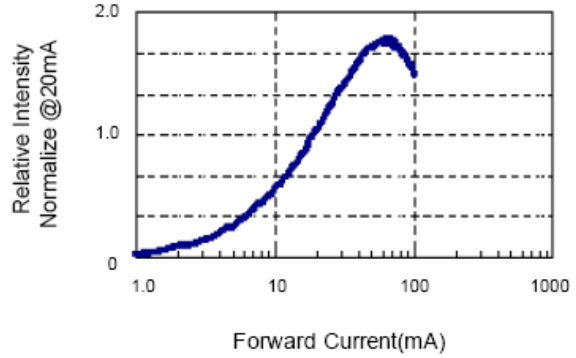

Fig.4 Relative Intensity vs. Temperature

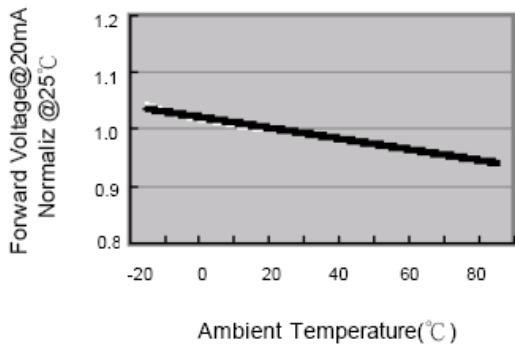

Fig.5 Relative Intensity vs. Wavelength

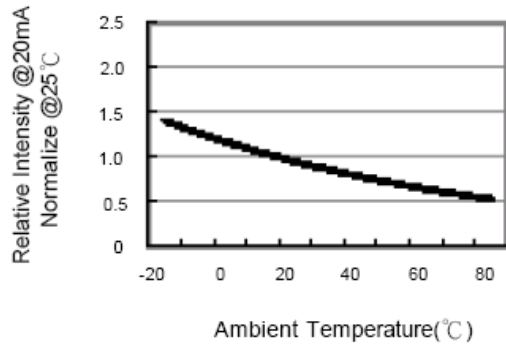
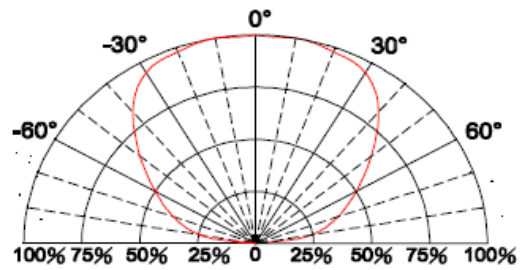
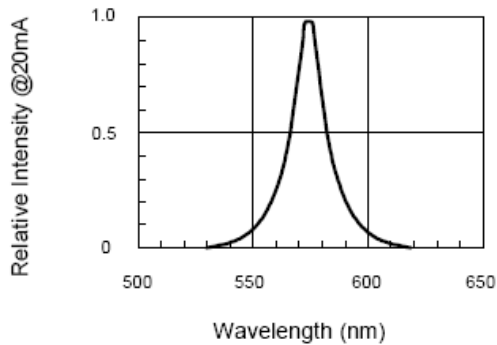

Fig.6 Directive Radiation



ChromeLED Corp. reserves the right to make changes at any time in order to supply the best product possible. The most current version of this document will always be available at: www.chromeled.com

OPTICAL CHARACTERISTIC CURVES - ORANGE

Fig.1 Forward current vs. Forward Voltage

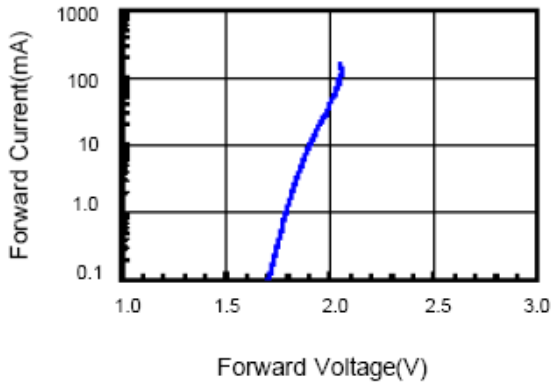

Fig.2 Relative Intensity vs. Forward Current

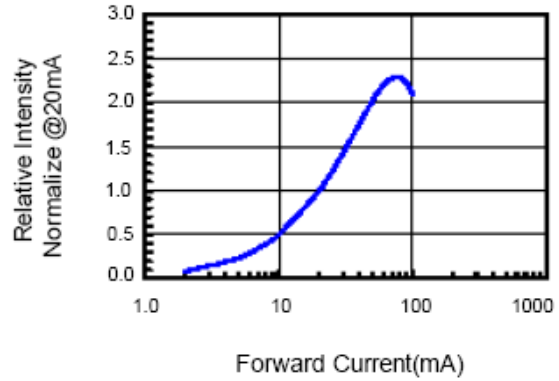

Fig.3 Forward Voltage vs. Temperature

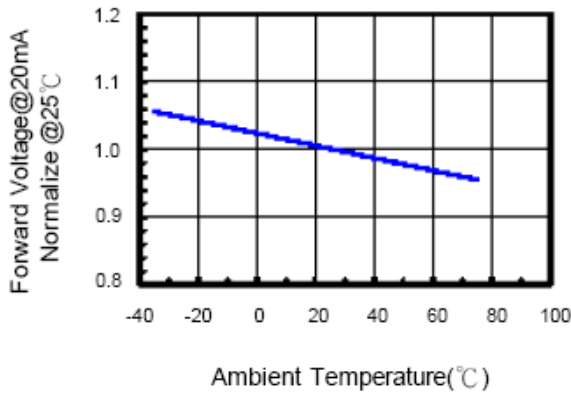

Fig.4 Relative Intensity vs. Temperature

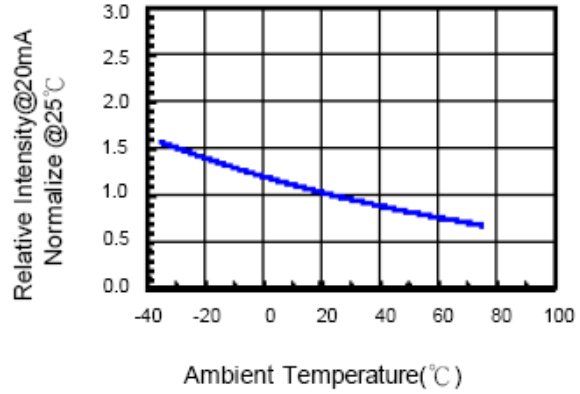

Fig.5 Relative Intensity vs. Wavelength

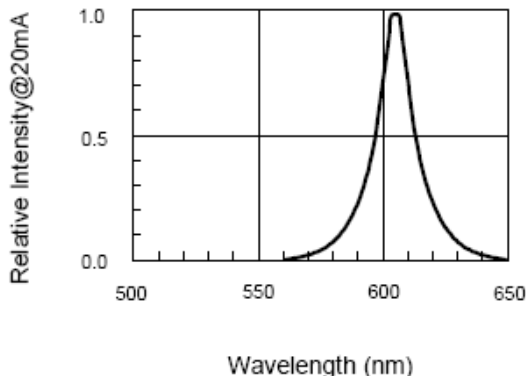
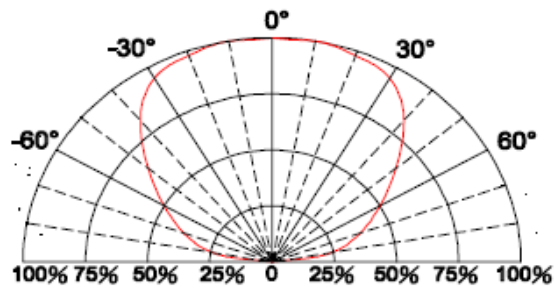
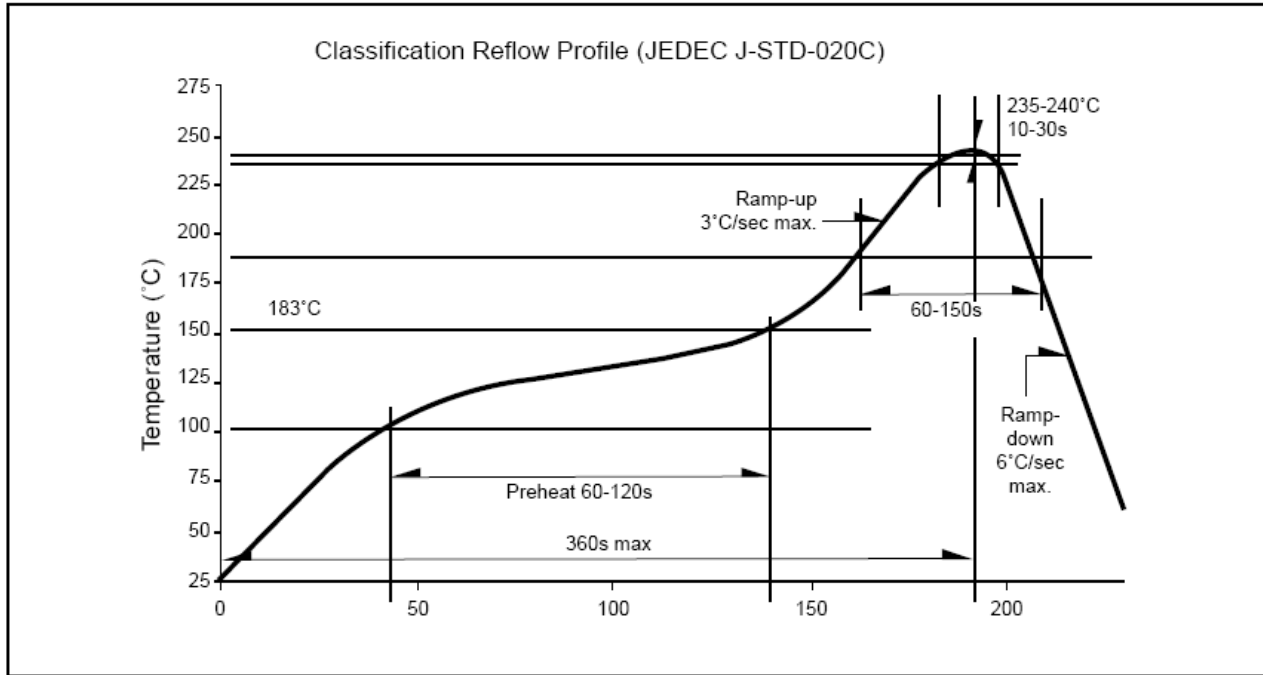
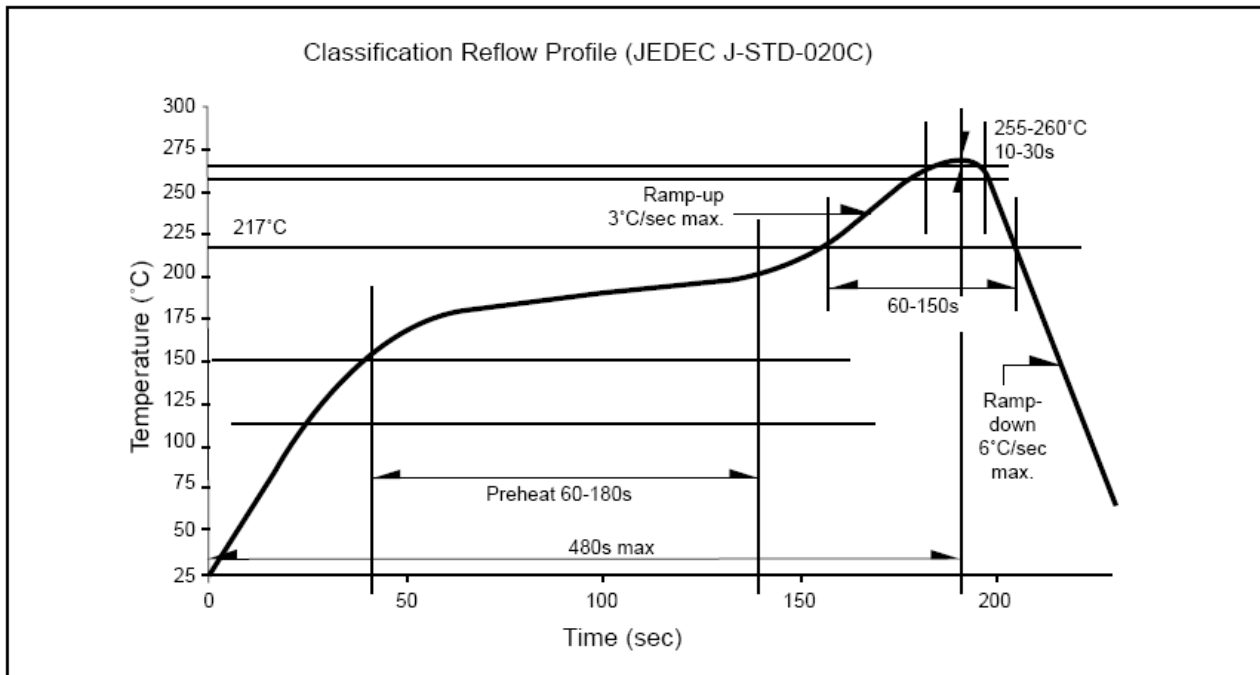

Fig.6 Directive Radiation



ChromeLED Corp. reserves the right to make changes at any time in order to supply the best product possible. The most current version of this document will always be available at: www.chromeled.com

SOLDERING CONDITIONS
RECOMMENDED Sn-PB IR-Reflow Soldering Profile

RECOMMENDED Pb-Free Soldering Profile

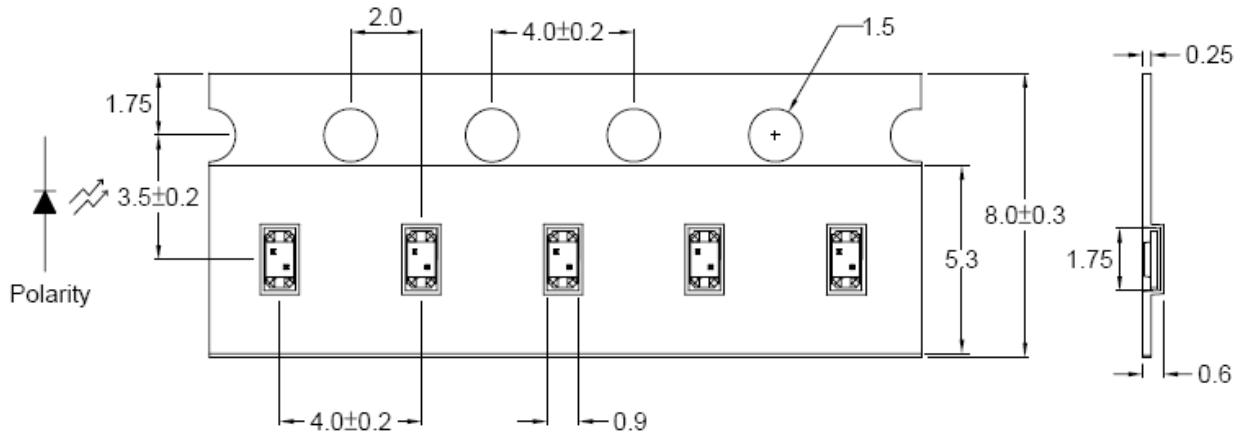
ChromeLED Corp. reserves the right to make changes at any time in order to supply the best product possible. The most current version of this document will always be available at: www.chromeled.com

REEL PACKAGING
CARRIER TAPE DIMENSION

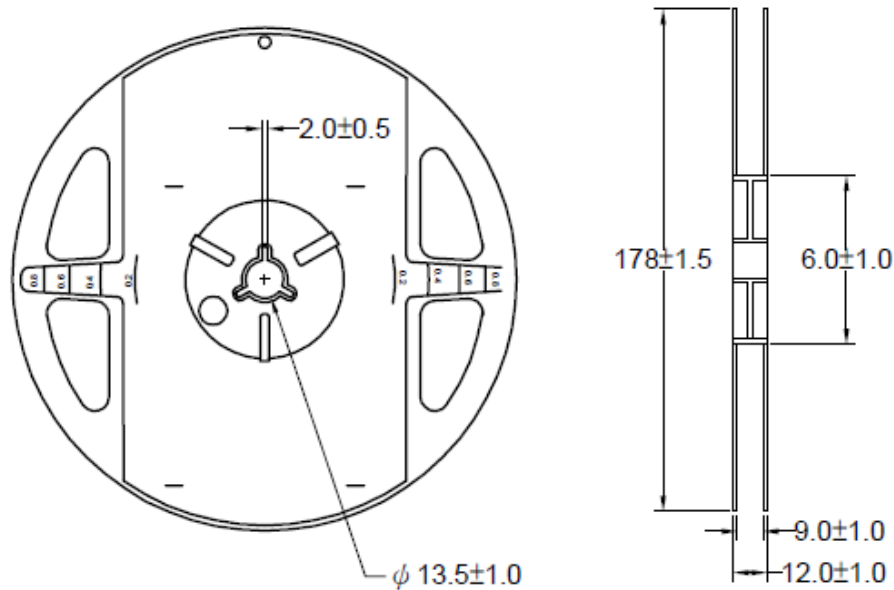
Note: The tolerances unless mentioned are ±0.1mm, Angle ±0.5; Unit=mm

REEL DIMENSIONS

Notes:

1. 4000 pieces per reel.



ChromeLED Corp. reserves the right to make changes at any time in order to supply the best product possible. The most current version of this document will always be available at: www.chromeled.com