



IGT™ TRANSISTORS

Insulated Gate Bipolar Transistor

IGT8D21,E21
**20 AMPERES
400, 500 VOLTS
EQUIV. R_{DS(ON)} = 0.145 Ω**

This IGT™ Transistor (Insulated Gate Bipolar Transistor) is a new type of MOS-gate turn on/off power switching device combining the best advantages of power MOSFETS and bipolar transistors. The result is a device that has the high input impedance of MOSFETS and the low on-state conduction losses similar to bipolar transistors. The device design and gate characteristics of the IGT™ Transistor are also similar to power MOSFETS. An important difference is the equivalent R_{DS(ON)} drain resistance which is modulated to a low value (10 times lower) when the gate is turned on. The much lower on-state voltage drop also varies only moderately between 25°C and 150°C offering extended power handling capability.

The IGT™ Transistor is ideal for many high voltage switching applications operating at low frequencies and where low conduction losses are essential, such as; AC and DC motor controls, power supplies and drivers for solenoids, relays and contactors.

Features:

- Low V_{CE(SAT)} — 2.5V typ @ 20A
- Ultra-fast turn-on — 150 ns typical
- Polysilicon MOS gate — Voltage controlled turn on/off
- High current handling — 20 amps @ 90°C

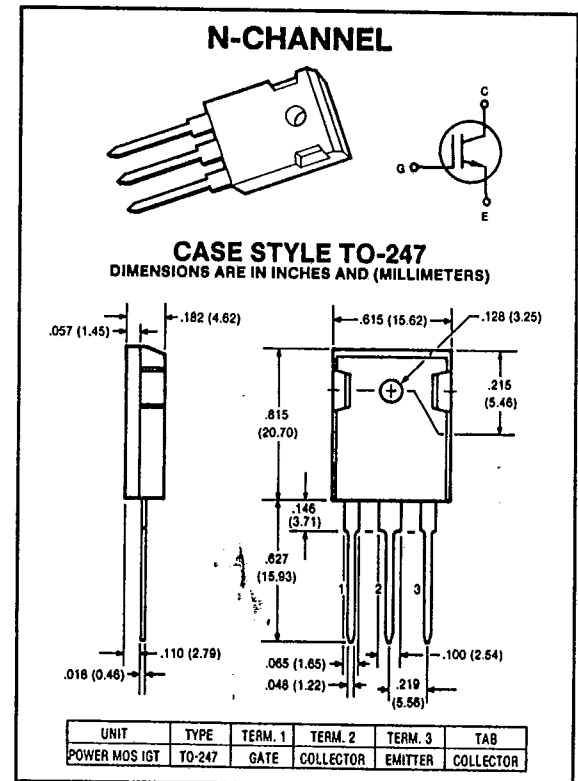

maximum ratings ($T_C = 25^\circ\text{C}$) (unless otherwise specified)

RATING	SYMBOL	IGT8D21	IGT8E21	UNITS
Collector-Emitter Voltage, $V_{GE} = 0V$	V_{CES}	400	500	Volts
Collector-Gate Voltage, $R_{GE} = 1M\Omega$	V_{CGR}	400	500	Volts
Continuous Drain Current @ $T_C = 90^\circ\text{C}$ @ $T_C = 25^\circ\text{C}$	I_C	20 32	20 32	A A
Pulsed Collector Current ⁽¹⁾	I_{CM}	80	80	A
Gate-Emitter Voltage	V_{GE}	± 25	± 25	Volts
Total Power Dissipation @ $T_C = 25^\circ\text{C}$ Derate Above 25°C	P_D	125 1.0	125 1.0	Watts W/°C
Operating and Storage Junction Temperature Range	T_J, T_{STG}	-55 to 150	-55 to 150	°C

thermal characteristics

Thermal Resistance, Junction to Case	$R_{\theta JC}$	1.0	1.0	°C/W
Maximum Lead Temperature for Soldering Purposes: 1/8" from Case for 5 Seconds	T_L	260	260	°C

(1) Repetitive Rating: Pulse width limited by max. junction temperature.

CHARACTERISTIC	SYMBOL	MIN	TYP	MAX	UNIT
----------------	--------	-----	-----	-----	------

off characteristics

Collector-Emitter Breakdown Voltage ($V_{GE} = 0\text{V}, I_C = 250\mu\text{A}$)	IGT8D21 IGT8E21	BV_{CES}	400 500	— —	— —	Volts
Collector Cut-off Current ($V_{CE} = \text{Max Rating}, V_{GE} = 0\text{V}, T_C = 25^\circ\text{C}$) ($V_{CE} = \text{Max Rating}, \times 0.8, V_{GE} = 0\text{V}, T_C = 125^\circ\text{C}$) ⁽²⁾		I_{CES}	— —	— —	250 4.0	μA mA
Gate-Emitter Leakage Current ($V_{GE} = \pm 20\text{V}$)		I_{GES}	—	—	± 500	nA

(2) Applies for 3.3°C per watt maximum thermal resistance, case to ambient.

on characteristics⁽³⁾

Gate Threshold Voltage ($V_{CE} = V_{GE}, I_C = 500\mu\text{A}$)	$T_C = 25^\circ\text{C}$ $T_C = 150^\circ\text{C}$	$V_{GE(TH)}$	2 —	4 2	5 —	Volts
Collector-Emitter Saturation Voltage $I_C = 20\text{A}, T_C = 25^\circ\text{C}, V_{GE} = 15\text{V}$ $I_C = 20\text{A}, T_C = 150^\circ\text{C}, V_{GE} = 15\text{V}$ $I_C = 20\text{A}, T_C = 25^\circ\text{C}, V_{GE} = 10\text{V}$		$V_{CE(SAT)}$	— — —	2.5 2.6 3.0	2.9 — —	Volts

dynamic characteristics

Input Capacitance	$V_{GE} = 0\text{V}$	C_{ies}	—	2300	—	pF
Output Capacitance	$V_{CE} = 25\text{V}$	C_{oes}	—	700	—	pF
Reverse Transfer Capacitance	$f = 1\text{MHz}$	C_{res}	—	10	—	pF

switching characteristics⁽³⁾ (see figures 8 & 9)

Turn-on Delay Time	Resistive Load $T_C = 125^\circ\text{C}$ $I_C = 20\text{A}, V_{CE} = \text{Rated } V_{CES}$ $V_{GE} = 15\text{V}$ $R_{G(on)} = 50\Omega, R_{GE} = 100\Omega$	$t_{d(on)}$	—	100	—	ns
Rise Time		t_r	—	150	—	ns
Turn-off Delay Time		$t_{d(off)}$	—	0.60	—	μs
Fall Time		t_f	—	3.0	—	μs
Turn-off Delay Time	Inductive Load, $T_C = 125^\circ\text{C}$, $L = 550\mu\text{H}, I_C = 20\text{A}$, $V_{CE(CLAMP)} = \text{Rated } V_{CES}$ $V_{GE} = 15\text{V}$	$t_{d(off)}$	—	0.8	1.4	μs
Fall Time		t_f	—	0.8	1.0	μs
Equivalent Fall Time		$t_{f(eq)}$	—	0.6	0.8	μs
Turn-off Switching Losses	$R_{G(on)} = 50\Omega, R_{GE} = 100\Omega$ IGT8D21 IGT8E21	E_f	—	2.6 3.2	3.2 4.0	mJ

(3) Pulse test: Pulse widths $\leq 300\mu\text{sec}$, duty cycle $\leq 2\%$.

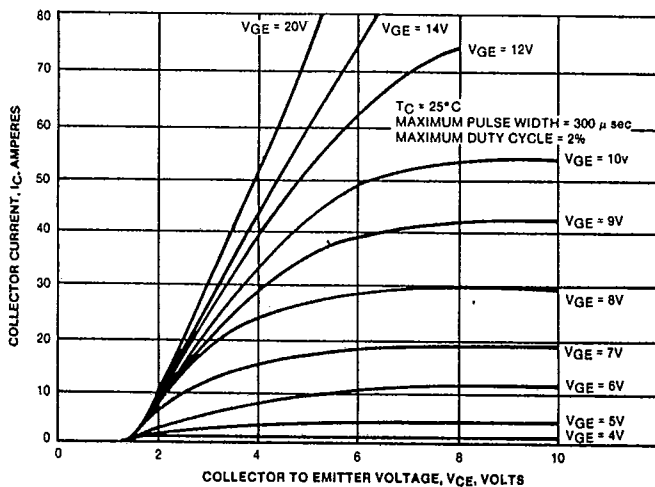

FIGURE 1. TYPICAL OUTPUT CHARACTERISTICS

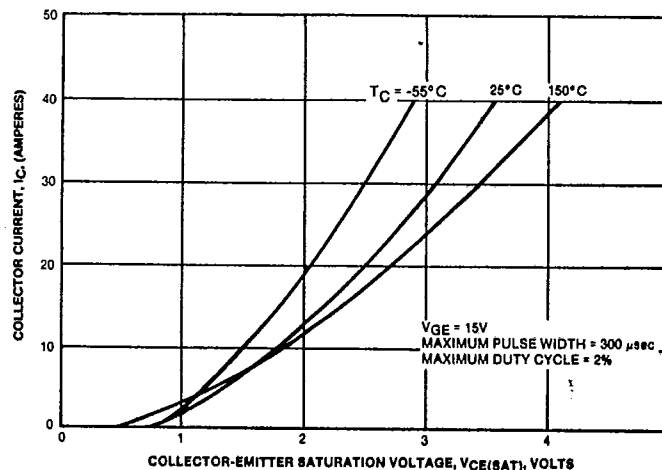

FIGURE 2. TYPICAL COLLECTOR-EMITTER SATURATION VOLTAGE

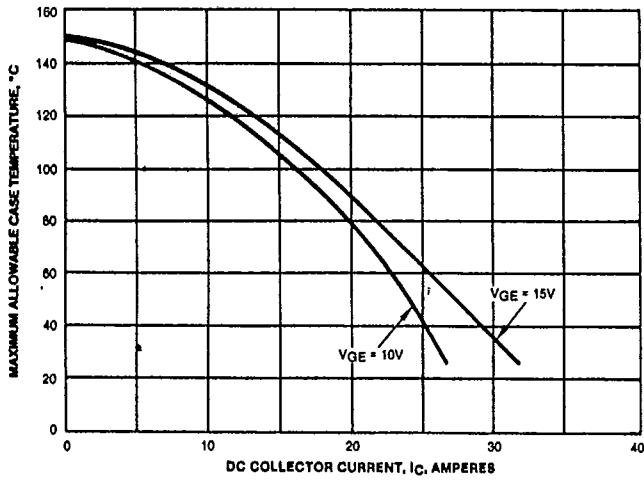

FIGURE 3. MAXIMUM ALLOWABLE CASE TEMPERATURE VS. DC COLLECTOR CURRENT

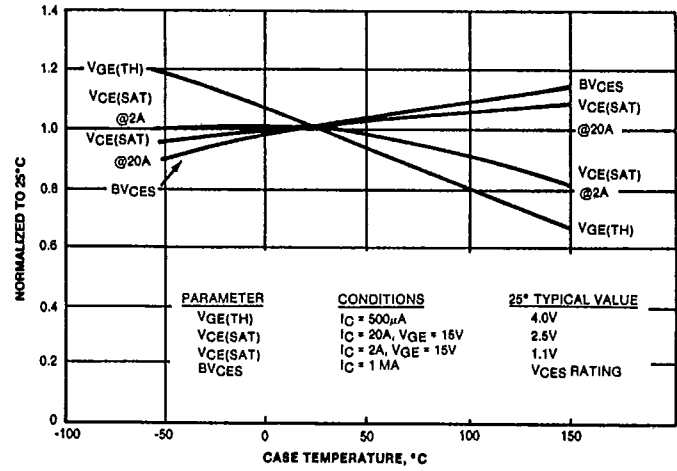

FIGURE 4. TYPICAL TEMPERATURE DEPENDENCE OF PARAMETERS

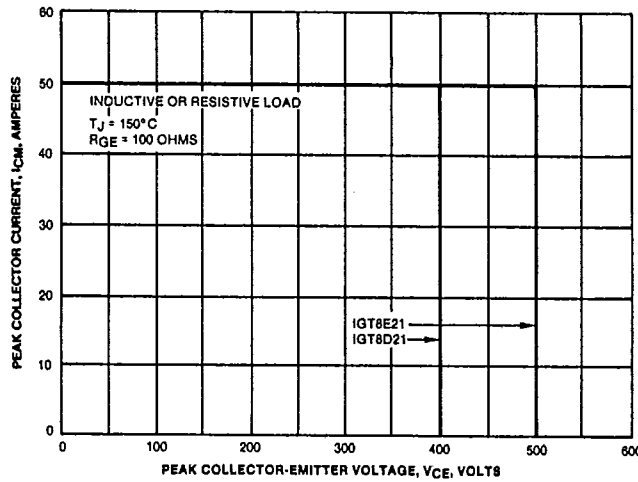

FIGURE 5. TURN-OFF SAFE OPERATING AREA

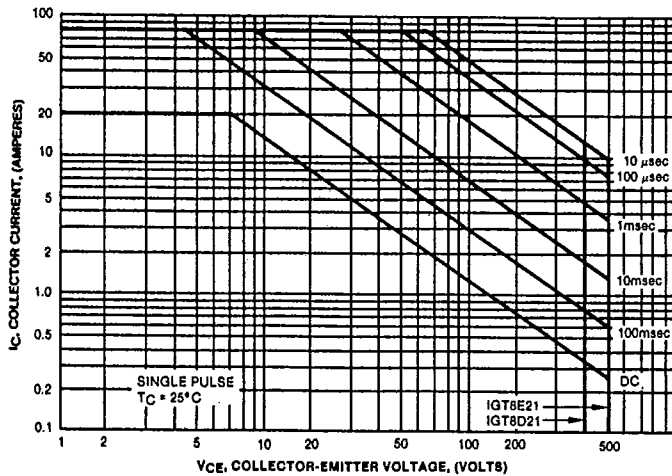

FIGURE 6. TURN-ON SAFE OPERATING AREA

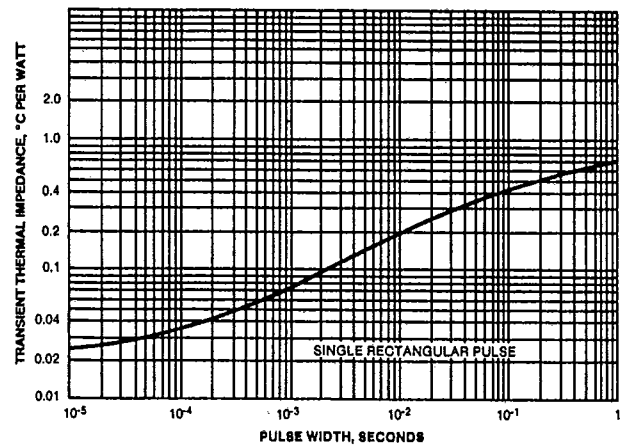
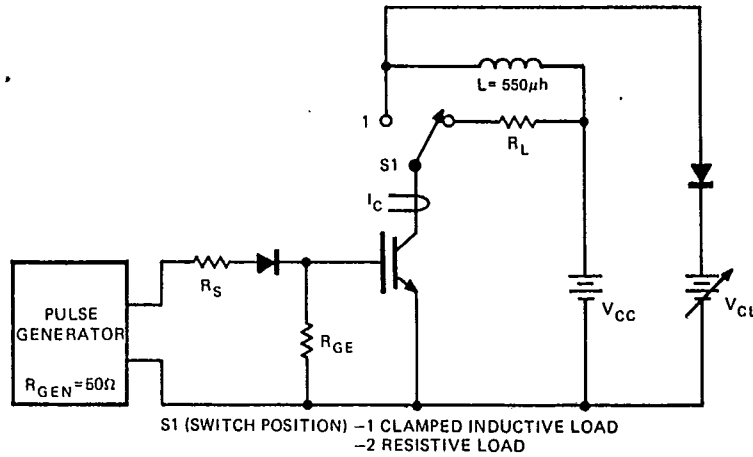
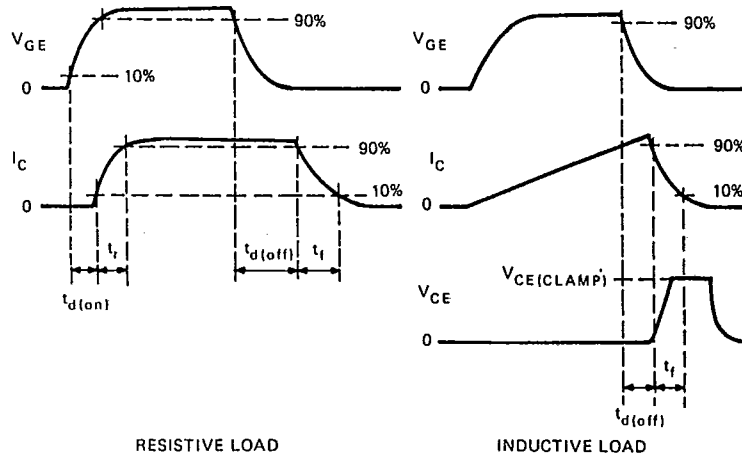

FIGURE 7. MAXIMUM TRANSIENT THERMAL IMPEDANCE



$$R_{G(ON)} = \frac{(R_{GEN} + R_S)(R_{GE})}{R_{GEN} + R_S + R_{GE}}, \text{ PULSE WIDTH} \geq 60 \mu\text{sec}, V_{CC} = \frac{L \cdot I_C (\text{MAXIMUM})}{\text{PULSE WIDTH}}$$

FIGURE 8. BASIC SWITCHING TEST CIRCUIT



(WAVEFORMS NOT TO SCALE)

FIGURE 9. SWITCHING WAVEFORMS