

Display ■ Through-hole EADCF056GA1

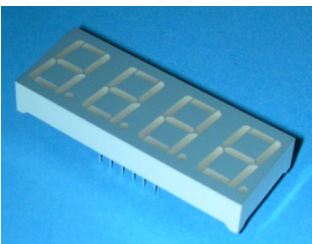

Features

- Industrial standard size.
- Low power consumption.
- Categorized for luminous intensity.
- Pb free and RoHS compliant.

Description

- The EADCF056GA1 is a 14.22mm (0.56") digit height seven-segment display.
- The display provides excellent reliability in bright ambient light.
- The device is made with white segments and gray surface.

Applications

- Home appliances
- Instrument panels
- Digital readout displays

Device Selection Guide

| Chip Materials | Emitted Color | Resin Color |
|----------------|------------------------|-----------------|
| AlGaInP | Brilliant Yellow Green | White Diffusion |

Absolute Maximum Ratings (Ta=25°C)

| Parameter | Symbol | Rating | Unit |
|---|-----------|------------|------|
| Reverse Voltage | V_R | 5 | V |
| Forward Current | I_F | 25 | mA |
| Peak Forward Current (Duty 1/10 @1KHz) | I_{FP} | 60 | mA |
| Power Dissipation | P_d | 60 | mW |
| Operating Temperature | T_{opr} | -40 ~ +85 | °C |
| Storage Temperature | T_{stg} | -40 ~ +100 | °C |
| Soldering Temperature (Soldering time ≤ 5 seconds) | T_{sol} | 260 | °C |

Electro-Optical Characteristics (Ta=25°C)

| Parameter | Symbol | Min. | Typ. | Max. | Unit | Condition |
|-----------------------------------|-----------------|-------|-------|-------|------|------------|
| Luminous Intensity ^{**1} | I_v | 2.8 | 6.4 | ----- | mcd | $I_F=10mA$ |
| Peak Wavelength | λ_p | ----- | 575 | ----- | nm | $I_F=20mA$ |
| Dominant Wavelength | λ_d | ----- | 573 | ----- | nm | $I_F=20mA$ |
| Spectrum Radiation Bandwidth | $\Delta\lambda$ | ----- | 20 | ----- | nm | $I_F=20mA$ |
| Forward Voltage | V_F | ----- | 2.0 | 2.4 | V | $I_F=20mA$ |
| Reverse Current | I_R | ----- | ----- | 100 | μA | $V_R=5V$ |

Note:

- Luminous Intensity is a average value which is measured one 7-segment.
- Tolerance of Luminous Intensity: ± 10 %
- Tolerance of Forward Voltage: ± 0.1V

Typical Electro-Optical Characteristics Curves

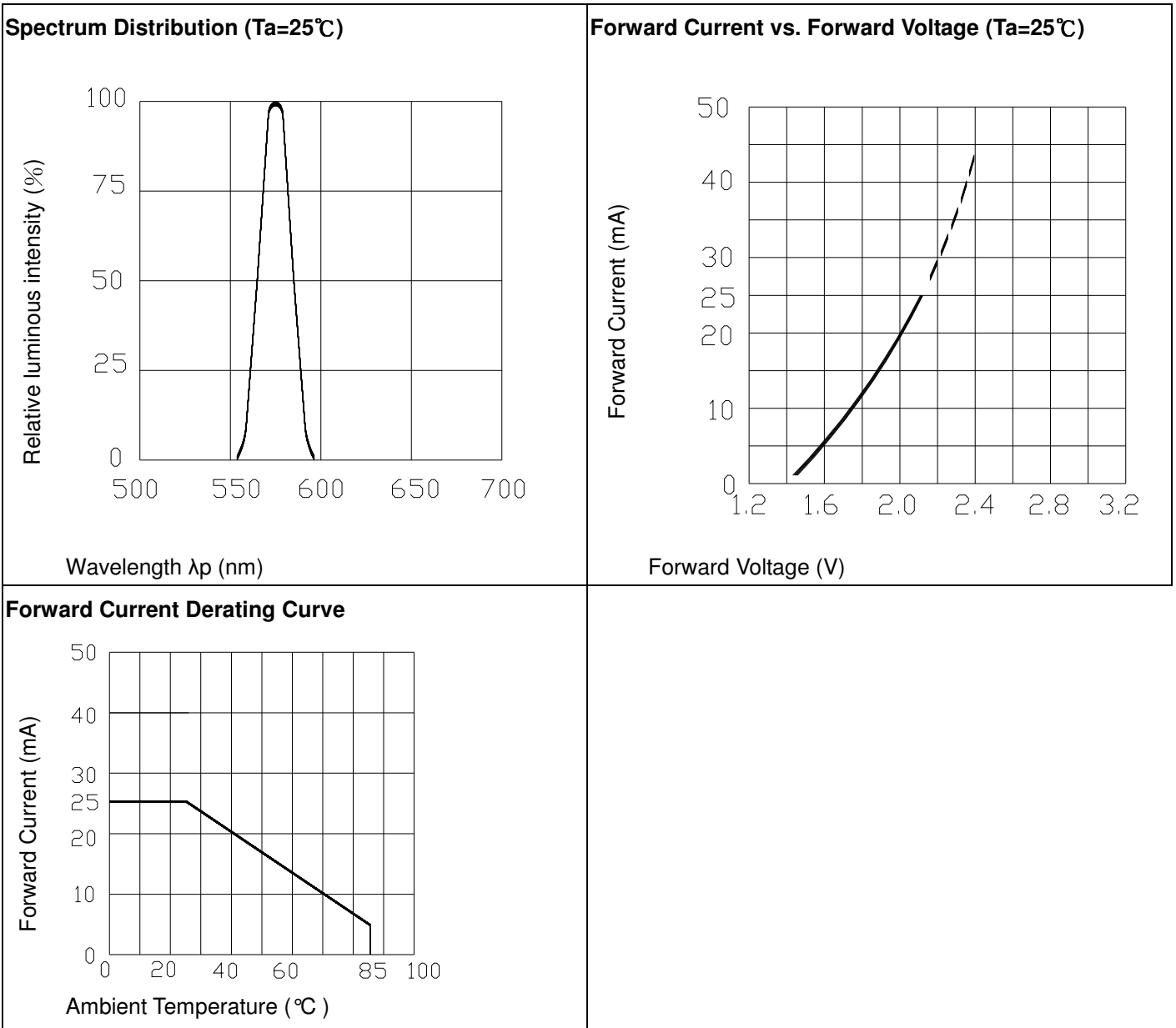

Package Dimension & Internal Circuit Diagram

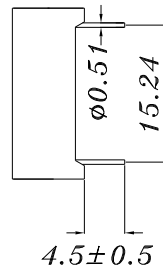
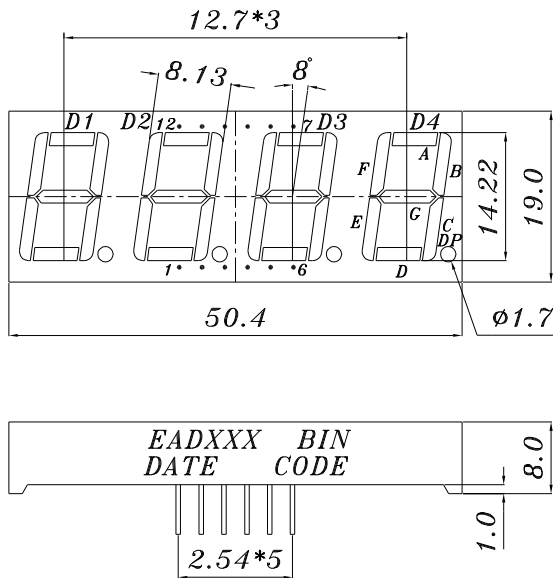

- COMMON CATHODE*
- 1 ANODE E
 - 2 ANODE D
 - 3 ANODE DP
 - 4 ANODE C
 - 5 ANODE G
 - 6 COMMON CATHODE D4
 - 7 ANODE B
 - 8 COMMON CATHODE D3
 - 9 COMMON CATHODE D2
 - 10 ANODE F
 - 11 ANODE A
 - 12 COMMON CATHODE D1

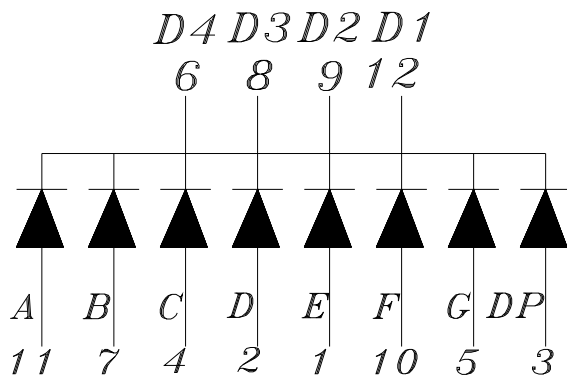

Note: Tolerances unless mentioned ± 0.25 mm. Unit = mm

Packing Materials

Label Explanation

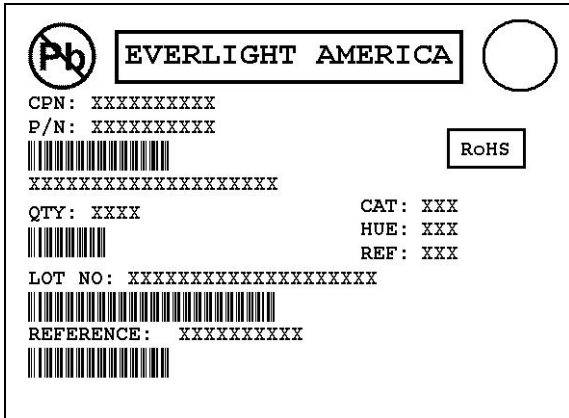

- CPN: Customer's Product Number
- P/N: Product Number
- QTY: Packing Quantity
- CAT: Luminous Intensity Rank
- HUE: Reference
- REF: Reference
- LOT No: Lot Number
- REFERENCE: Volume Label code

Packing Process

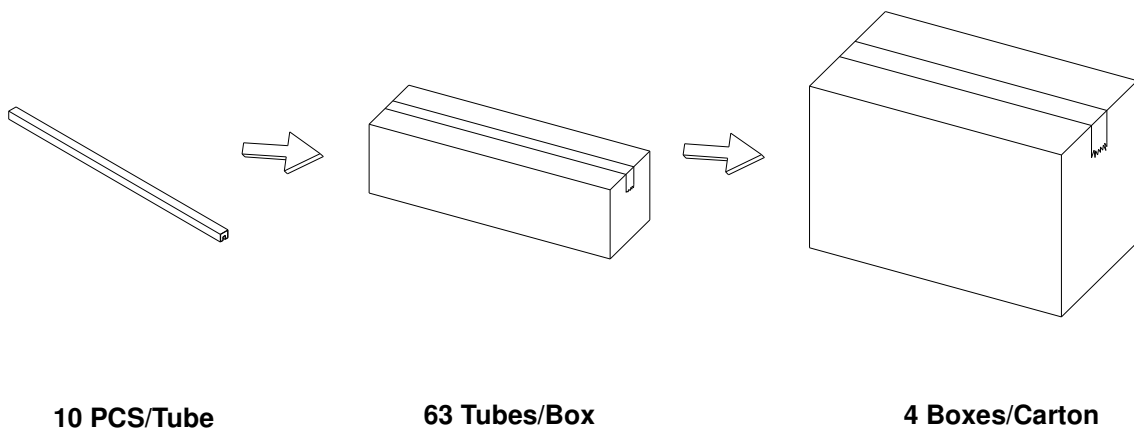

Application Restrictions

1. Specification described in this document. Above specification may be changed without notice. EVERLIGHT Americas will reserve authority on material change for above specification.
2. When using this product, please observe the absolute maximum ratings and the instructions for using outlined in these specification sheets. EVERLIGHT Americas assumes no responsibility for any damage resulting from use of the product which does not comply with the absolute maximum ratings and the instructions included in these specification sheets.
3. These specification sheets include materials protected under copyright of EVERLIGHT Americas Corporation. Please don't reproduce or cause anyone to reproduce them without EVERLIGHT Americas' consent.
4. ESD (Electrostatic Discharge)
 - The products are sensitive to static electricity or surge voltage. ESD can damage a die and its reliability. When handling the products, the following measures against electrostatic discharge are strongly recommended:
 - Eliminating the charge
 - Grounded wrist strap, ESD footwear, clothes, and floors
 - Grounded workstation equipment and tools
 - ESD table/shelf mat made of conductive materials
 - Proper grounding is required for all devices, equipment, and machinery used in product assembly. Surge protection should be considered when designing of commercial products.
 - If tools or equipment contain insulating materials such as glass or plastic, the following measures against electrostatic discharge are strongly recommended:
 - Dissipating static charge with conductive materials
 - Preventing charge generation with moisture
 - Neutralizing the charge with ionizers
5. The LEDs should be operated with forward bias. The driving circuit must be designed so that the LEDs are not subjected to forward or reverse voltage while it is off. If reverse voltage is continuously applied to the LEDs, it may cause migration resulting in LED damage.