

Product Summary

V _{RRM} (V)	I _O (A)	V _F MAX (V)	I _R MAX (mA)
100	6	0.74	0.1

Description

The SBR6100CTLQ is dual center tap rectifier in TO252 (Standard) package. Offering excellent high temperature stability and superior avalanche capability, this device is specifically intended for use in automotive applications.

Applications

- DC - DC Converters
- DC/AC Inverters
- AC/DC Power Supplies

Features

- Low Forward Voltage Drop (V_F); Better Efficiency and Cooler Operation
- Reduced High Temperature Reverse Leakage; Increased Reliability against Thermal Runaway Failure in High Temperature Operation
- Excellent High Temperature Stability
- Patented Super Barrier Rectifier (SBR[®]) Technology
- Soft, Fast Switching Capability
- +150°C Operating Junction Temperature
- **Lead-Free Finish; RoHS Compliant (Notes 1 & 2)**
- **Halogen and Antimony Free. "Green" Device (Note 3)**
- **The SBR6100CTLQ is suitable for automotive applications requiring specific change control and is AEC-Q101 qualified, is PPAP capable, and is manufactured in IATF16949:2016 certified facilities.**

Mechanical Data

- Case: TO252
- Case Material: Molded Plastic, "Green" Molding Compound. UL Flammability Classification Rating 94V-0
- Moisture Sensitivity: Level 1 per J-STD-020
- Terminals: Finish - Matte Tin Annealed over Copper Leadframe. Solderable per MIL-STD-202, Method 208 ⁽³⁾
- Polarity: See Below
- Weight: 0.33 grams (Approximate)

TO252 (Standard)

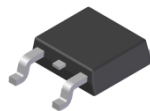

Top View

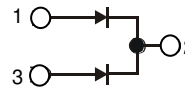

Package Pin-Out Configuration

Ordering Information (Note 4)

Part Number	Case	Packaging
SBR6100CTLQ-13	TO252 (Standard)	2500/Tape & Reel

- Notes:
1. EU Directive 2002/95/EC (RoHS), 2011/65/EU (RoHS 2) & 2015/863/EU (RoHS 3) compliant. All applicable RoHS exemptions applied.
 2. See http://www.diodes.com/quality/lead_free/ for more information about Diodes Incorporated's definitions of Halogen- and Antimony-free, "Green" and Lead-free.
 3. Halogen- and Antimony-free "Green" products are defined as those which contain <900ppm bromine, <900ppm chlorine (<1500ppm total Br + Cl) and <1000ppm antimony compounds.
 4. For packaging details, go to our website at <https://www.diodes.com/design/support/packaging/diodes-packaging/>.

Marking Information

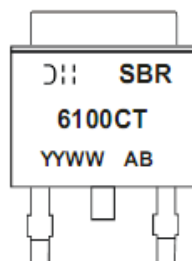

SBR6100CT = Product Type Marking Code
 AB = Foundry and Assembly Code
 YYWW = Date Code Marking
 YY = Last Two Digits of Year (ex: 19 = 2019)
 WW = Week (01 to 53)

Maximum Ratings (@ $T_A = +25^\circ\text{C}$, unless otherwise specified.)

Single phase, half wave, 60Hz, resistive or inductive load.
For capacitive load, derate current by 20%.

Characteristic	Symbol	Value	Unit
Peak Repetitive Reverse Voltage	V_{RRM}	100	V
Working Peak Reverse Voltage	V_{RWM}		
DC Blocking Voltage	V_{RM}		
RMS Reverse Voltage	$V_{R(RMS)}$	71	V
Average Rectified Output Current @ $T_C = +115^\circ\text{C}$	I_O	6	A
Non-Repetitive Peak Forward Surge Current 8.3ms Single Half Sine-Wave Superimposed on Rated Load	I_{FSM}	78	A
Repetitive Peak Avalanche Power (1 μs , +25 $^\circ\text{C}$)	P_{ARM}	7000	W
Non-Repetitive Avalanche Energy ($T_J = +25^\circ\text{C}$, $I_{AS} = 6\text{A}$, $L = 8.5\text{mH}$)	E_{AS}	120	mJ

Thermal Characteristics

Characteristic	Symbol	Value	Unit
Maximum Thermal Resistance, Junction to Ambient (Per Leg) (Note 5)	$R_{\theta JA}$	49	$^\circ\text{C}/\text{W}$
Operating and Storage Temperature Range	T_J, T_{STG}	-65 to +150	$^\circ\text{C}$

Electrical Characteristics (@ $T_A = +25^\circ\text{C}$, unless otherwise specified.)

Characteristic	Symbol	Min	Typ	Max	Unit	Test Condition
Forward Voltage Drop (Per Leg)	V_F	—	0.68	0.74	V	$I_F = 3\text{A}, T_J = +25^\circ\text{C}$
			0.56	0.62		$I_F = 3\text{A}, T_J = +125^\circ\text{C}$
Leakage Current (Note 6) (Per Leg)	I_R	—	—	0.1	mA	$V_R = 100\text{V}, T_J = +25^\circ\text{C}$
				12		$V_R = 100\text{V}, T_J = +125^\circ\text{C}$

Notes: 5. Device mounted on Poly substrate PC board, 1oz copper, with minimum recommended pad layout.
6. Short duration pulse test used to minimize self-heating effect.

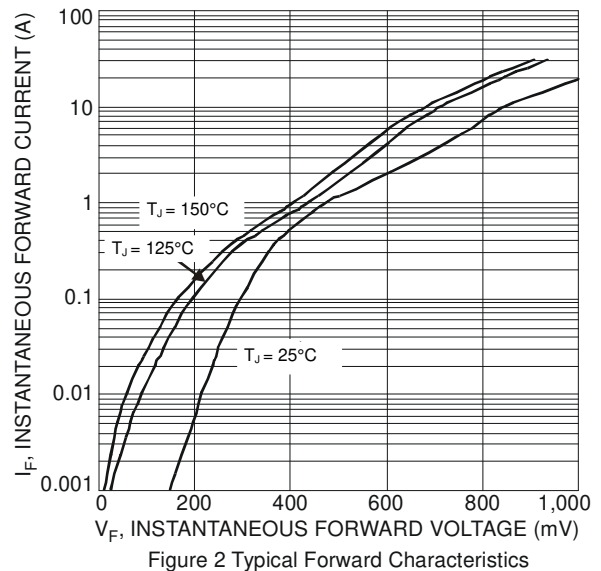
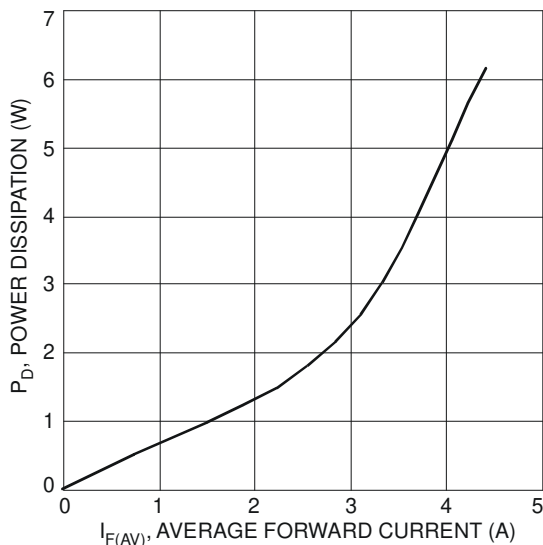

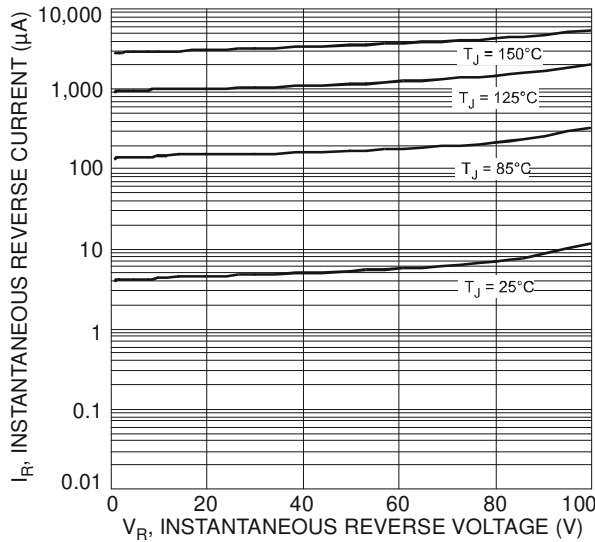

Figure 3 Typical Reverse Characteristics

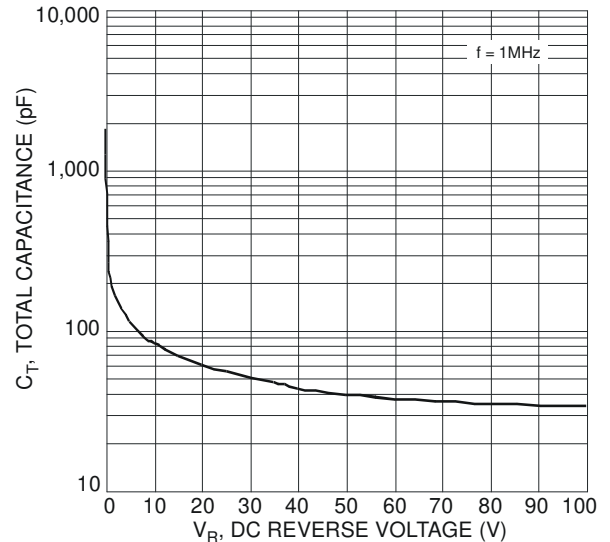

Figure 4 Total Capacitance vs. Reverse Voltage

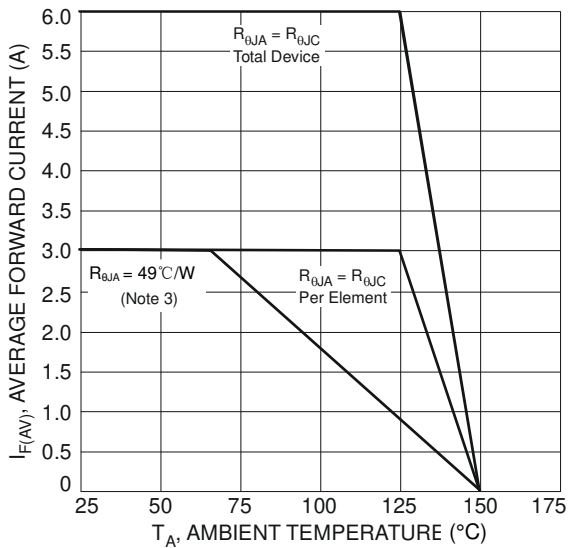

Figure 5 Forward Current Derating Curve

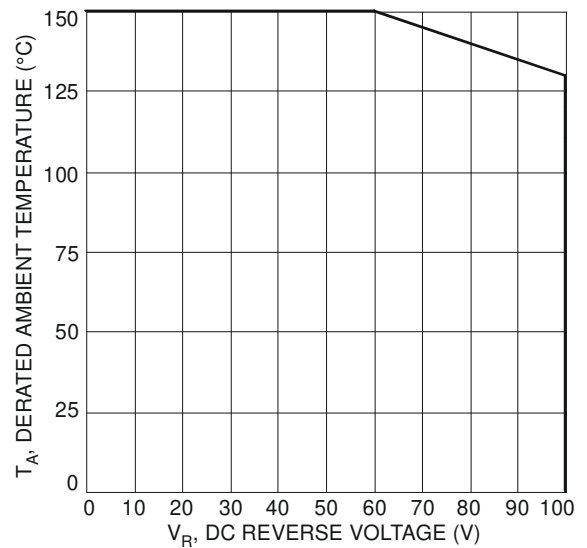

Figure 6 Operating Temperature Derating

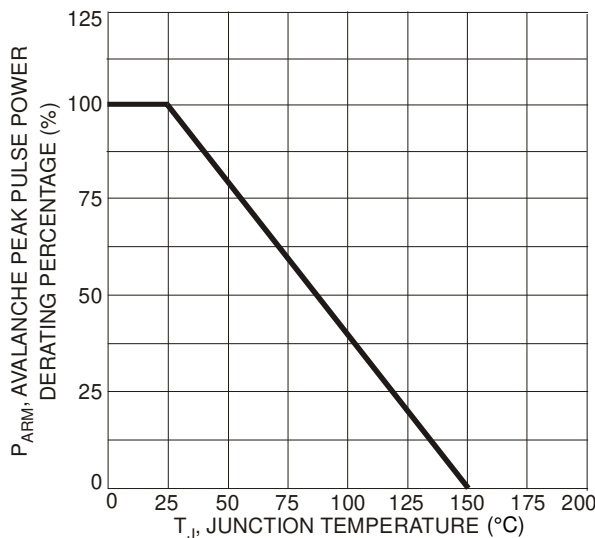

Figure 7 Pulse Derating Curve, Per Element

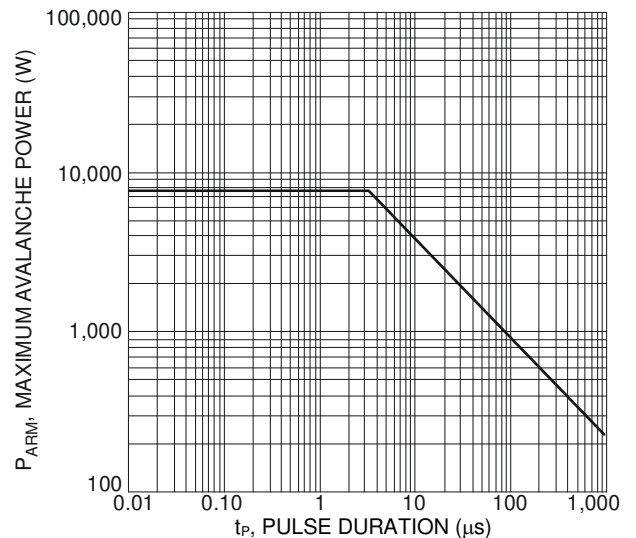

Figure 8 Maximum Avalanche Power Curve, Per Element

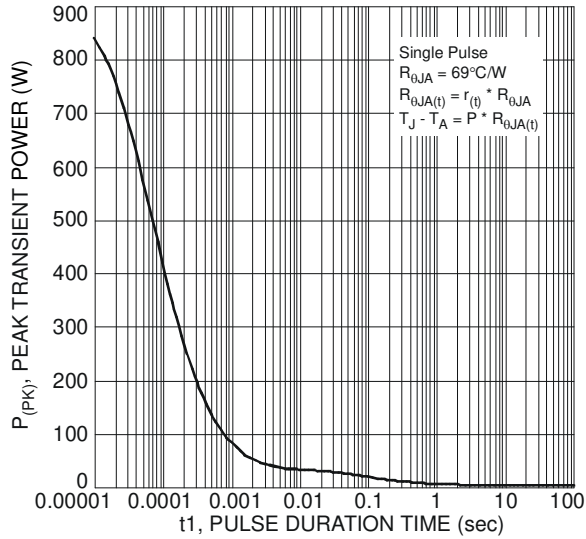

Figure 9 Single Pulse Maximum Power Dissipation

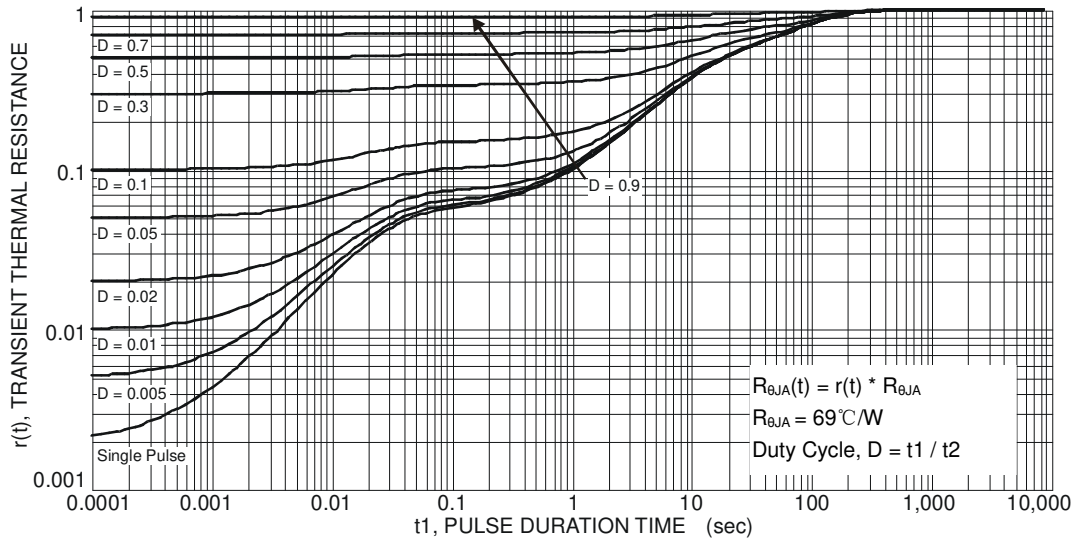
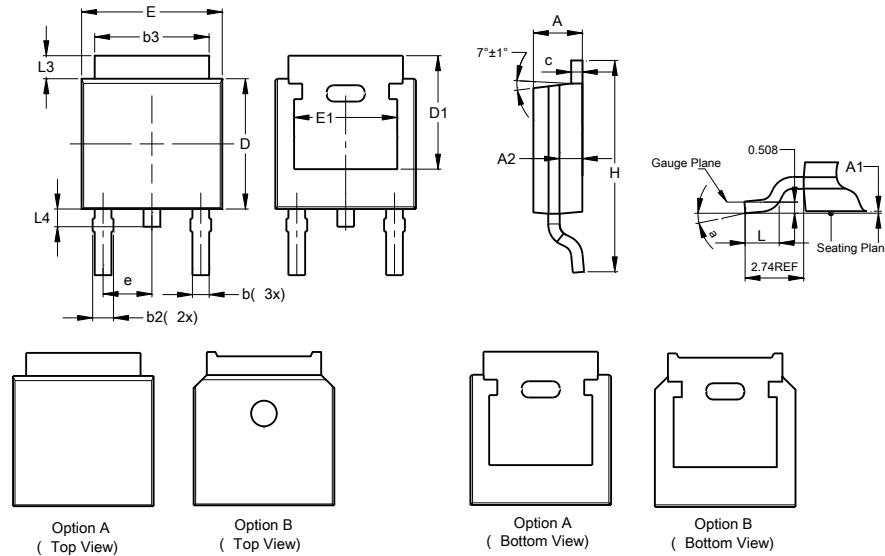

Figure 10 Transient Thermal Resistance

Package Outline Dimensions

Please see <http://www.diodes.com/package-outlines.html> for the latest version.

TO252 (Standard)



TO252 (Standard)			
Dim	Min	Max	Typ
A	2.19	2.39	2.29
A1	0.00	0.13	0.08
A2	0.97	1.17	1.07
b	0.64	0.88	0.783
b2	0.76	1.14	0.95
b3	5.21	5.46	5.33
c	0.45	0.58	0.531
D	6.00	6.20	6.10
D1	5.21	-	-
e	-	-	2.286
E	6.45	6.70	6.58
E1	4.32	-	-
H	9.40	10.41	9.91
L	1.40	1.78	1.59
L3	0.88	1.27	1.08
L4	0.60	1.02	0.83
a	0°	10°	-
All Dimensions in mm			

Suggested Pad Layout

Please see <http://www.diodes.com/package-outlines.html> for the latest version.

TO252 (Standard)

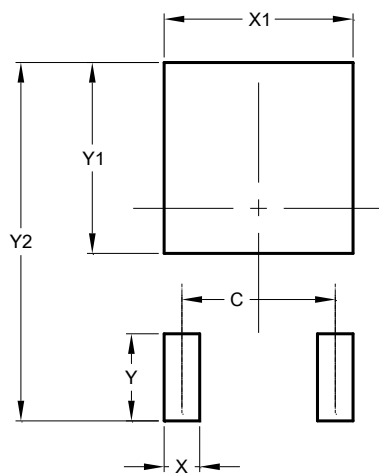

Dimensions	Value (in mm)
C	4.572
X	1.060
X1	5.632
Y	2.600
Y1	5.700
Y2	10.700

IMPORTANT NOTICE

DIODES INCORPORATED MAKES NO WARRANTY OF ANY KIND, EXPRESS OR IMPLIED, WITH REGARDS TO THIS DOCUMENT, INCLUDING, BUT NOT LIMITED TO, THE IMPLIED WARRANTIES OF MERCHANTABILITY AND FITNESS FOR A PARTICULAR PURPOSE (AND THEIR EQUIVALENTS UNDER THE LAWS OF ANY JURISDICTION).

Diodes Incorporated and its subsidiaries reserve the right to make modifications, enhancements, improvements, corrections or other changes without further notice to this document and any product described herein. Diodes Incorporated does not assume any liability arising out of the application or use of this document or any product described herein; neither does Diodes Incorporated convey any license under its patent or trademark rights, nor the rights of others. Any Customer or user of this document or products described herein in such applications shall assume all risks of such use and will agree to hold Diodes Incorporated and all the companies whose products are represented on Diodes Incorporated website, harmless against all damages.

Diodes Incorporated does not warrant or accept any liability whatsoever in respect of any products purchased through unauthorized sales channel. Should Customers purchase or use Diodes Incorporated products for any unintended or unauthorized application, Customers shall indemnify and hold Diodes Incorporated and its representatives harmless against all claims, damages, expenses, and attorney fees arising out of, directly or indirectly, any claim of personal injury or death associated with such unintended or unauthorized application.

Products described herein may be covered by one or more United States, international or foreign patents pending. Product names and markings noted herein may also be covered by one or more United States, international or foreign trademarks.

This document is written in English but may be translated into multiple languages for reference. Only the English version of this document is the final and determinative format released by Diodes Incorporated.

LIFE SUPPORT

Diodes Incorporated products are specifically not authorized for use as critical components in life support devices or systems without the express written approval of the Chief Executive Officer of Diodes Incorporated. As used herein:

A. Life support devices or systems are devices or systems which:

1. are intended to implant into the body, or
2. support or sustain life and whose failure to perform when properly used in accordance with instructions for use provided in the labeling can be reasonably expected to result in significant injury to the user.

B. A critical component is any component in a life support device or system whose failure to perform can be reasonably expected to cause the failure of the life support device or to affect its safety or effectiveness.

Customers represent that they have all necessary expertise in the safety and regulatory ramifications of their life support devices or systems, and acknowledge and agree that they are solely responsible for all legal, regulatory and safety-related requirements concerning their products and any use of Diodes Incorporated products in such safety-critical, life support devices or systems, notwithstanding any devices- or systems-related information or support that may be provided by Diodes Incorporated. Further, Customers must fully indemnify Diodes Incorporated and its representatives against any damages arising out of the use of Diodes Incorporated products in such safety-critical, life support devices or systems.

Copyright © 2019, Diodes Incorporated

www.diodes.com