

WiFi Dual Band PCB Substrate Antenna
Model: AA258
Product Number: H2B1PC1A1C095L

REFERENCE SPECIFICATION

Table of Contents

1	Introduction.....	3
2	Electrical Characteristics.....	4
2.1	Table with electrical properties:.....	4
2.2	Return Loss (S_{11}).....	5
2.3	VSWR (S_{11}).....	5
2.4	Efficiency Table.....	6
2.5	Efficiency vs. Frequency.....	7
2.6	Radiation Pattern.....	8
3	Antenna Dimensions.....	13
4	Notes.....	14
4.1	Operating conditions.....	14
4.2	Storage conditions.....	14
4.3	Cables and connectors.....	14

1 Introduction

Unictron's PCB antenna with cable series are specially designed for IEEE802.11(a/b/g/n/ac) applications. Based on Unictron's proprietary design and processes, this antenna has excellent stability and sensitivity to consistently provide high signal reception efficiency.

Features

- * Stable and reliable in performances
- * Compact size
- * RoHS compliance

Applications

- * IEEE802.11(a/b/g/n/ac)
- * Hand-held devices when IEEE802.11(a/b/g/n/ac) functions are needed.

2 Electrical Characteristics

2.1 Table with electrical properties:

2400 – 2500 MHz Band

Characteristics		Specifications	Unit
Outline Dimensions		25.0 x 7.0 x 0.5	mm
Working Frequency		2400 – 2500	MHz
Bandwidth **		90 (min)	MHz
VSWR (@Center Frequency)*		2 (max)	
Characteristic Impedance		50	Ω
Polarization		Linear Polarization	
Gain	Peak	0.9 (typical)	dBi
	Efficiency	56 (typical)	%

* Center frequency will be offset to another frequency according to the conditions of user's ground plane and radome.

** Bandwidth & VSWR are tested at Unitron test environment.

4900 – 5900 MHz Band

Characteristics		Specifications	Unit
Working Frequency		4900 – 5900	MHz
Bandwidth **		1000 (min)	MHz
VSWR (@Center Frequency)*		2 (max)	
Characteristic Impedance		50	Ω
Polarization		Linear Polarization	
Gain	Peak	3.8 (typical)	dBi
	Efficiency	89 (typical)	%

* Center frequency will be offset to another frequency according to the conditions of user's ground plane and radome.

** Bandwidth & VSWR are tested at Unitron test environment.

2.2 Return Loss (S_{11})

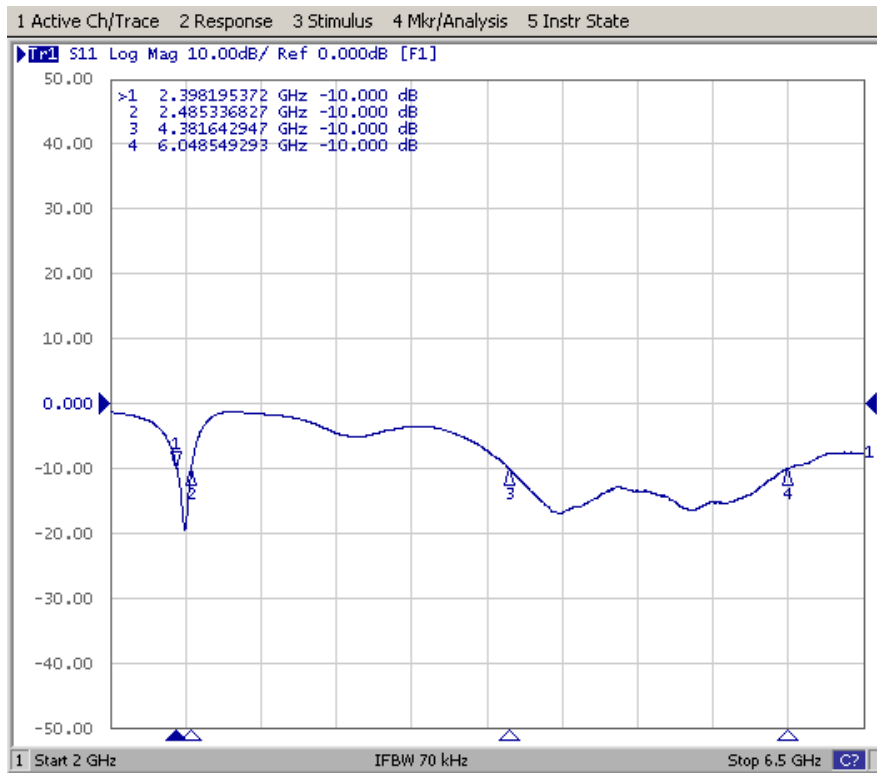

2.3 VSWR (S_{11})

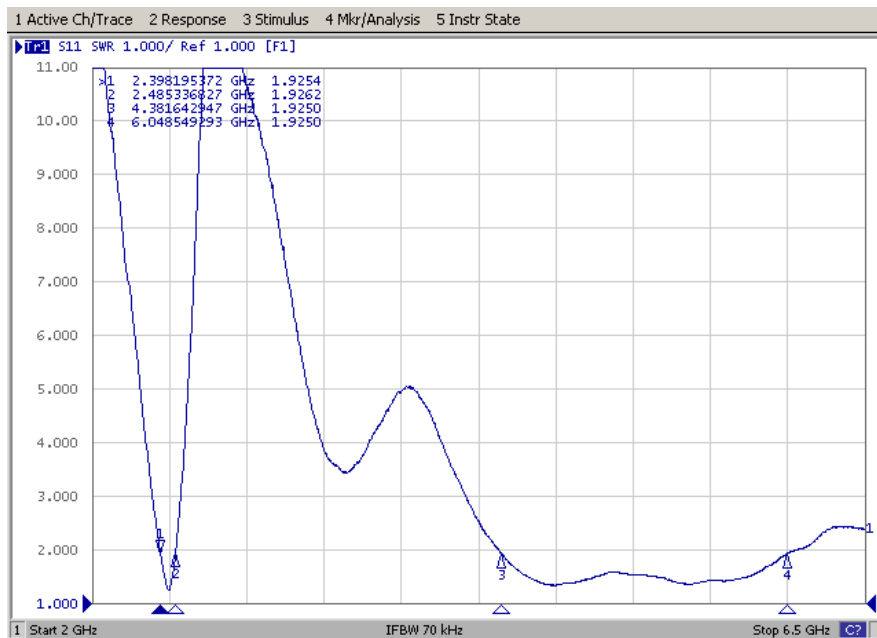

2.4 Efficiency Table

Frequency(MHz)	2.400	2.412	2.417	2.422	2.427	2.432	2.437	2.442	2.447	2.452	2.457	2.462	2.467	2.472	2.484	2.500
Efficiency(dB)	-3.34	-2.93	-2.77	-2.69	-2.60	-2.56	-2.55	-2.51	-2.64	-2.72	-2.66	-2.57	-2.67	-2.96	-3.22	-3.27
Efficiency(%)	46.34	50.93	52.84	53.83	54.95	55.46	55.59	56.10	54.45	53.46	54.20	55.34	54.08	50.58	47.64	47.10
Gain(dBi)	-0.13	0.34	0.45	0.66	0.77	0.86	0.96	0.97	0.79	0.66	0.61	0.77	0.73	0.49	0.23	0.26

Frequency(MHz)	4.900	4.950	5.000	5.050	5.100	5.150	5.200	5.250	5.300	5.350	5.400
Efficiency(dB)	-0.87	-0.56	-1.12	-1.11	-1.14	-0.84	-0.47	-0.51	-0.52	-0.71	-1.12
Efficiency(%)	81.85	87.9	77.27	77.45	76.91	82.41	89.74	88.92	88.72	84.84	77.27
Gain(dBi)	4.07	4.41	3.84	3.69	3.36	3.58	3.81	3.65	3.53	3.60	3.19

Frequency(MHz)	5.450	5.500	5.550	5.600	5.650	5.700	5.750	5.800	5.850	5.900
Efficiency(dB)	-1.61	-1.19	-1.00	-0.74	-0.96	-1.00	-1.04	-0.98	-0.93	-0.90
Efficiency(%)	69.02	76.03	79.43	84.33	80.17	79.43	78.7	79.8	80.76	81.28
Gain(dBi)	2.66	3.46	3.92	3.58	3.26	3.36	3.43	3.09	3.30	3.75

2.5 Efficiency vs. Frequency

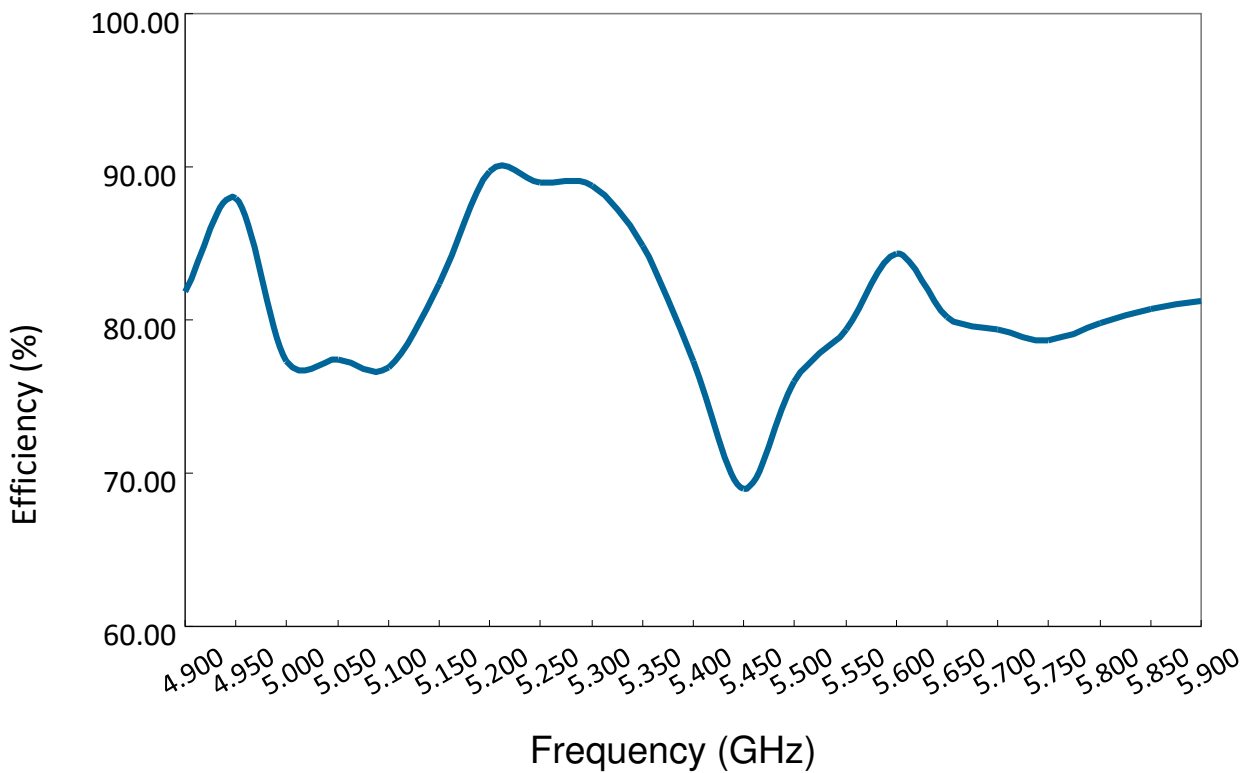
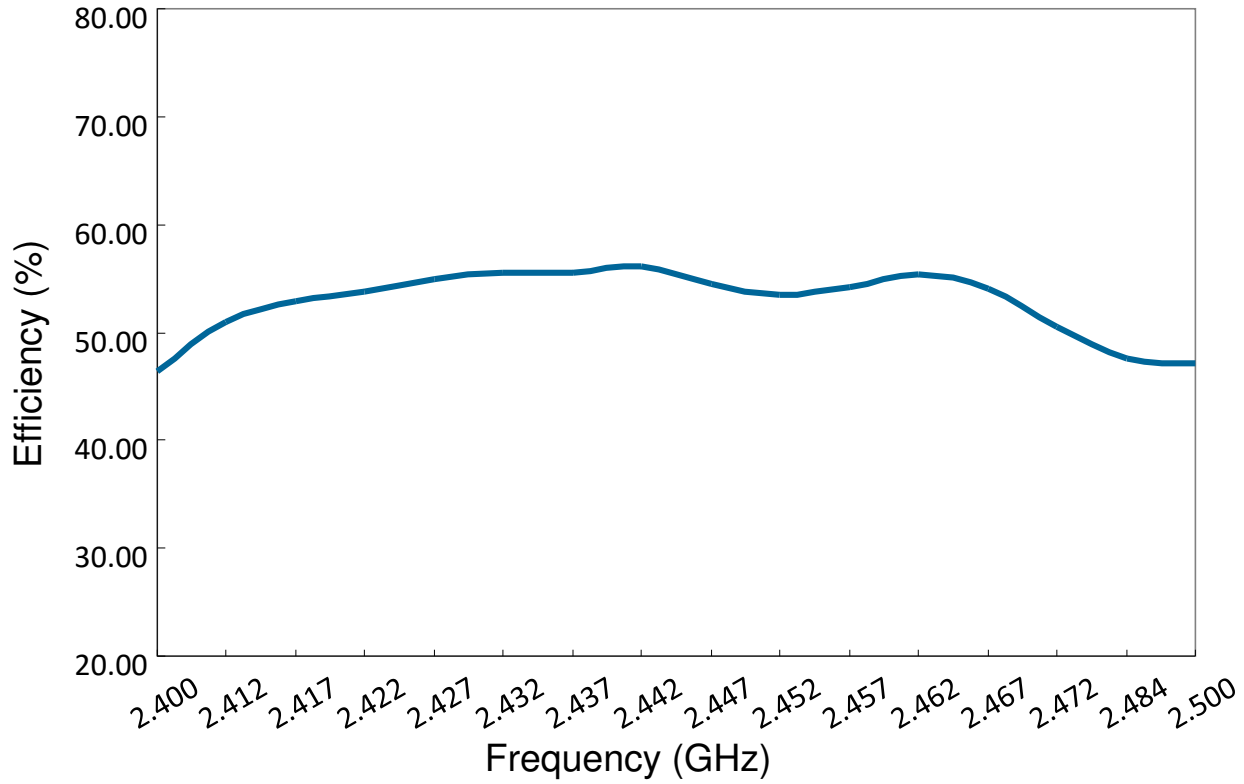

2.6 Radiation Pattern

3D Gain Pattern @ 2442 MHz (unit: dBi)

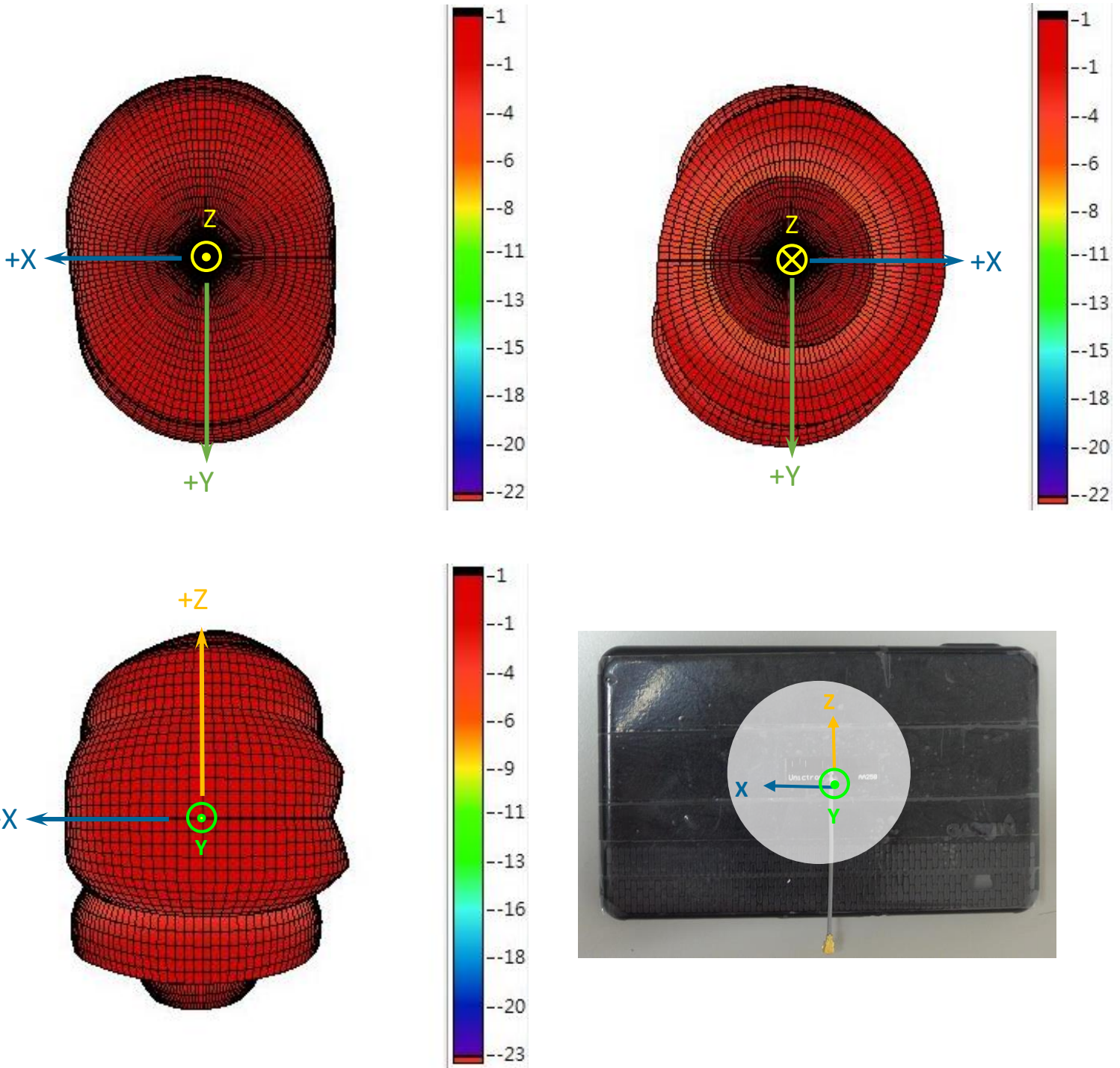

3D Gain Pattern @ 4900 MHz (unit: dBi)

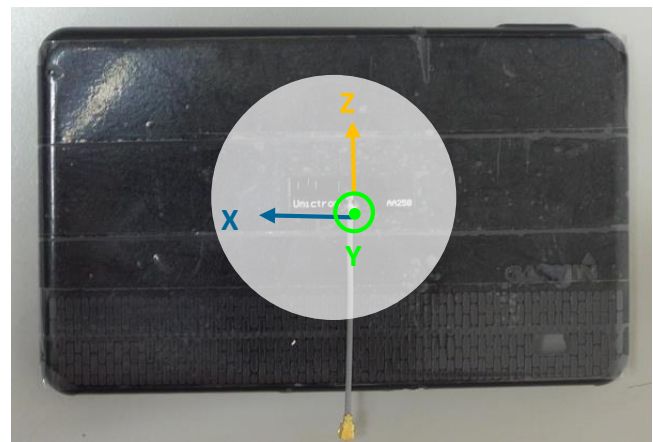
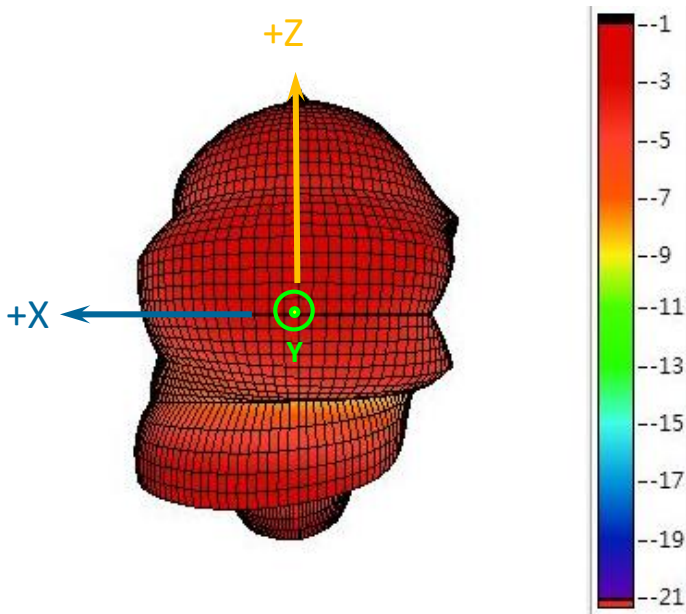
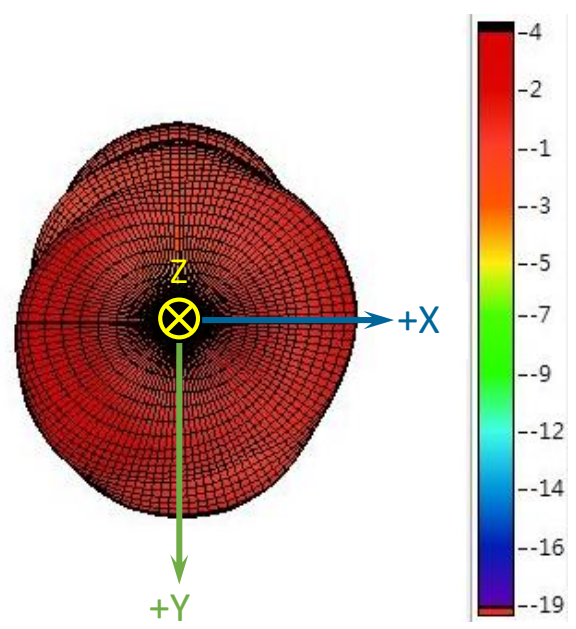
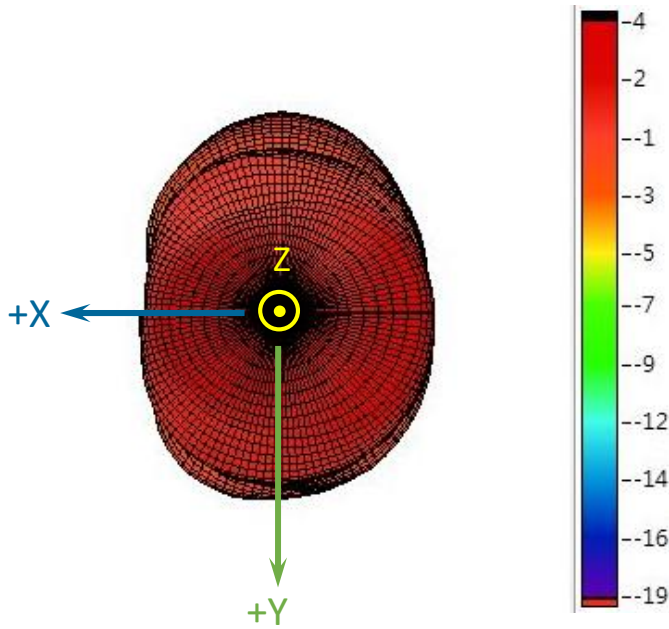

3D Gain Pattern @ 5150 MHz (unit: dBi)

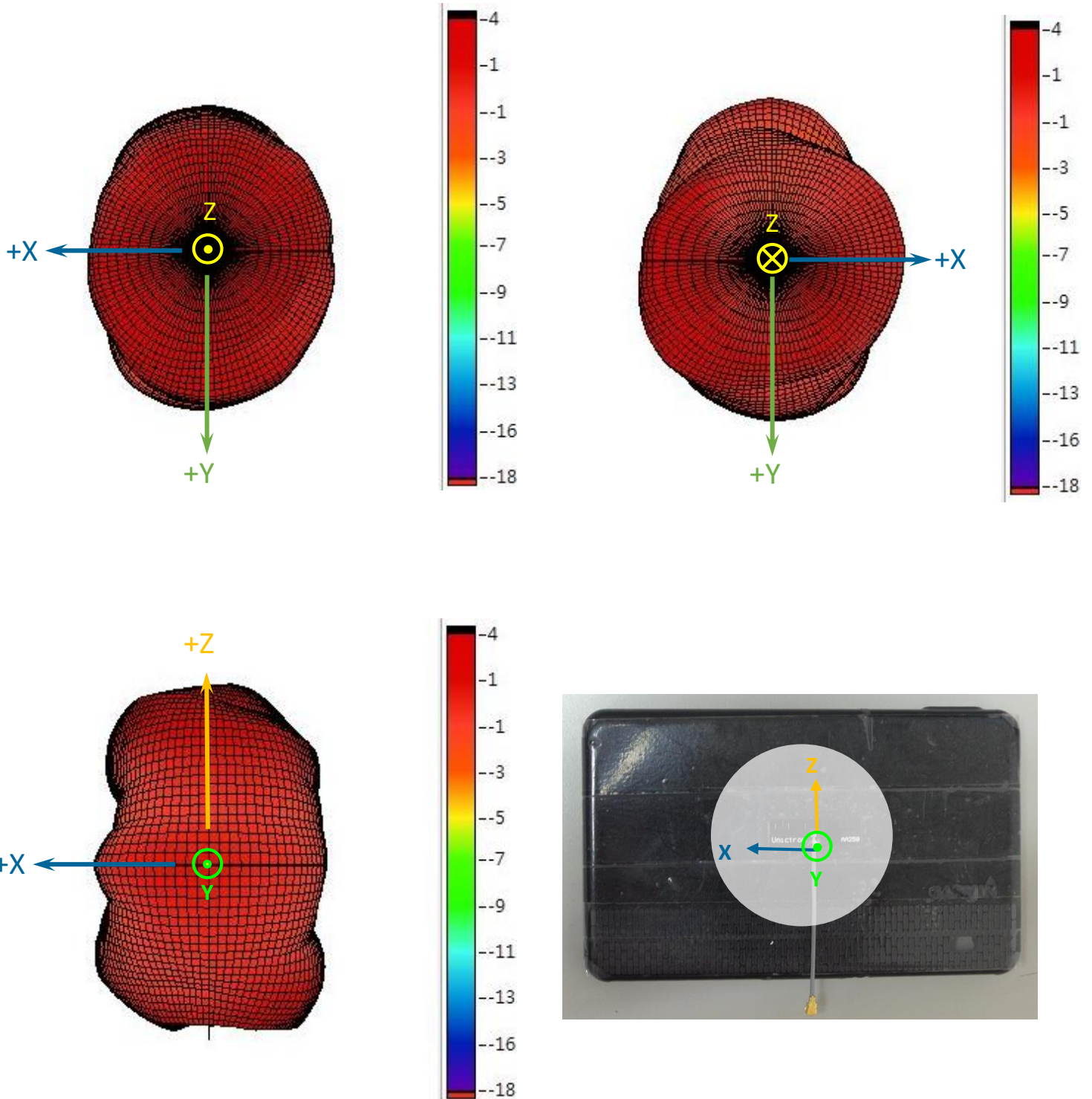

3D Gain Pattern @ 5500 MHz (unit: dBi)

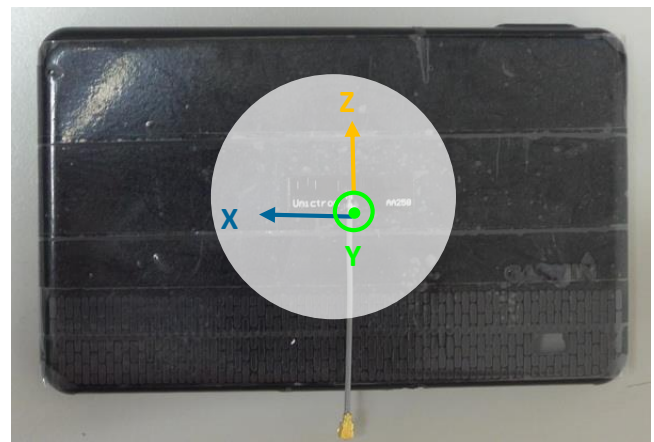
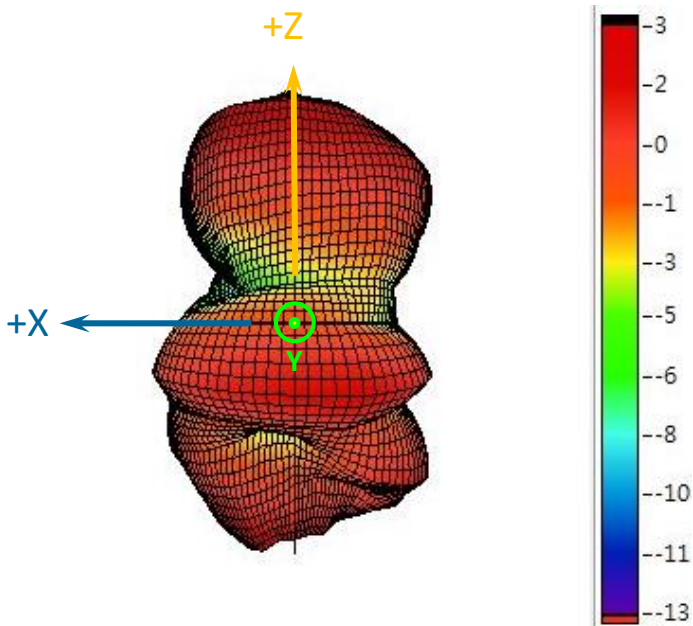
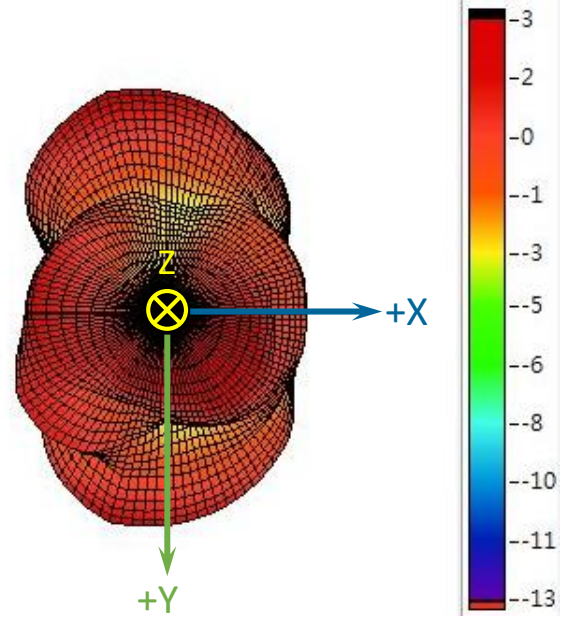
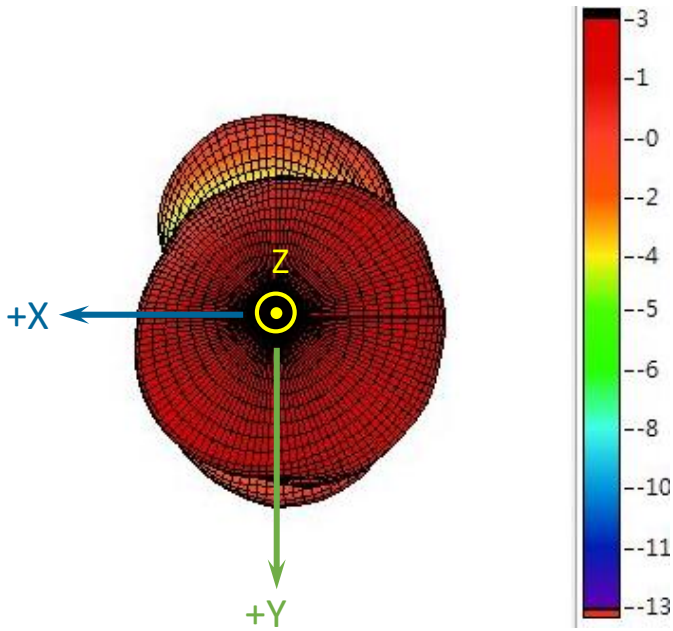

3D Gain Pattern @ 5850 MHz (unit: dBi)

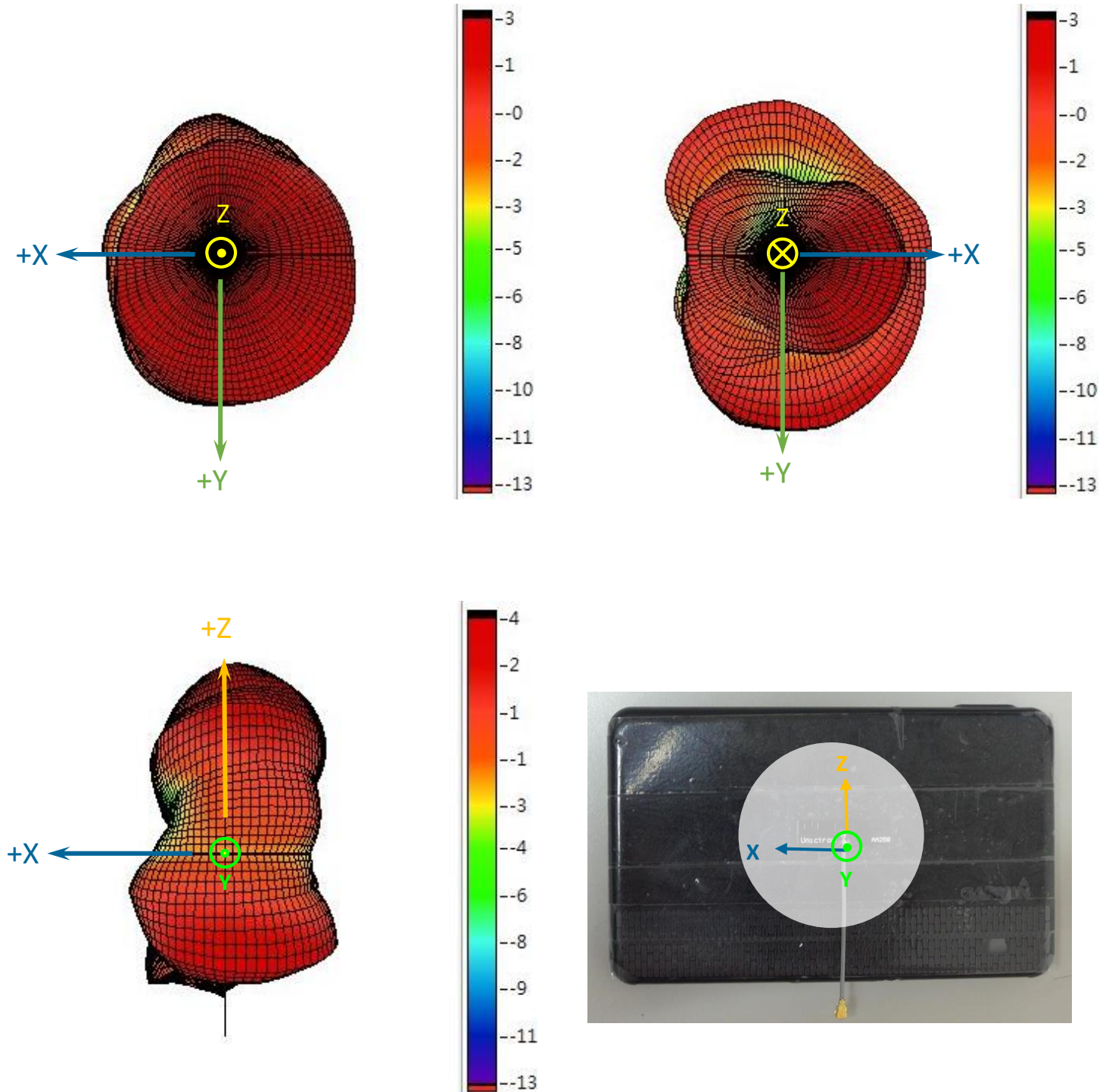

3 Antenna Dimensions

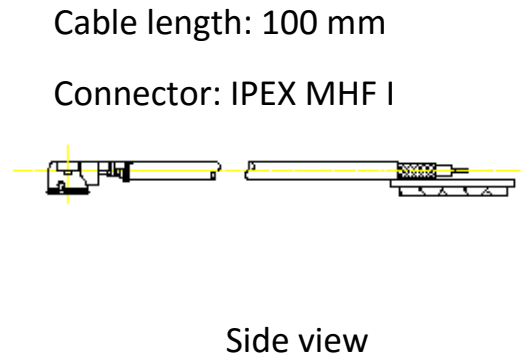
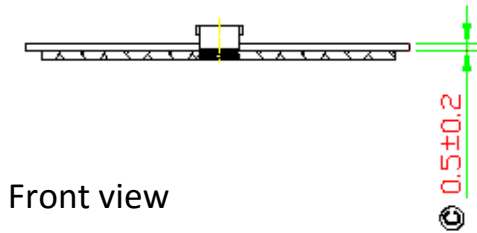
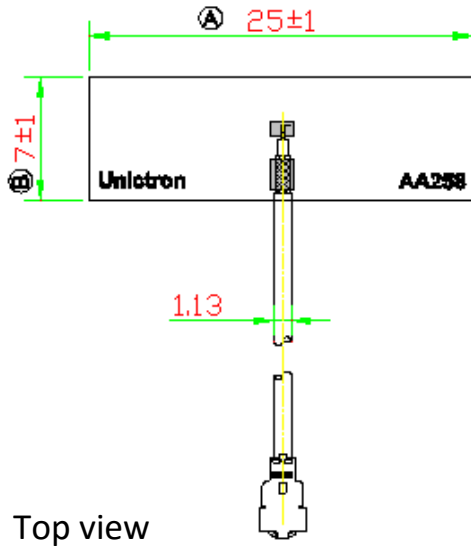

Unit: mm

4 Notes

4.1 Operating conditions

Temperature:	-10°C to +85°C (With double-sided tape)
	-40°C to +85°C (Without double-sided tape)
Humidity	10 to 95% RH

4.2 Storage conditions

Temperature:	-10°C to +85°C (With double-sided tape)
	-40°C to +85°C (Without double-sided tape)
Humidity	10 to 95% RH

4.3 Cables and connectors

The AA222 PCB antenna is provided with a standard cable 100mm long and IPEX MHF I connector.

Change of the cable length and type, connector type is possible upon request.

The actual performance of the antenna will depend on the environment of the device antenna is placed into. For the optimal performance avoid using antenna near metal parts like metal housing, display, battery, metal buttons, etc.

Feel free to contact us in regard of optimal antenna placement in your device.

Information presented in this Reference Specification is believed to be correct as of the date of publishing. Unictron Technologies Corporation reserves the rights to change the Reference Specification without notice due to technical improvements, etc. Please consult with Unictron's engineering team about the latest information before using this product. Per request, we may provide advice and assistance in implementing this antenna to a customer's device by simulation or real measurement of the interested device in our testing facilities.

Unictron Technologies Corporation

No. 41 Shuei-Keng, Guan-Si

Hsinchu 30648

Taiwan (R.O.C.)

Tel: +886-3-547-5550

Email: e-sales@unictron.com

Web: www.unictron.com