

### CoolSiC™ 1200 V SiC Trench MOSFET : Silicon Carbide MOSFET

#### Features

- $V_{DSS} = 1200\text{ V}$  at  $T_{vj} = 25^\circ\text{C}$
- $I_{DC} = 98\text{ A}$  at  $T_c = 25^\circ\text{C}$
- $R_{DS(on)} = 19\text{ m}\Omega$  at  $V_{GS} = 18\text{ V}$ ,  $T_{vj} = 25^\circ\text{C}$
- Very low switching losses
- Short circuit withstand time  $3\ \mu\text{s}$
- Benchmark gate threshold voltage,  $V_{GS(th)} = 4.2\text{ V}$
- Robust against parasitic turn on,  $0\text{ V}$  turn-off gate voltage can be applied
- Robust body diode for hard commutation
- .XT interconnection technology for best-in-class thermal performance

#### Potential applications

- General purpose drives (GPD)
- EV-Charging
- Online UPS/Industrial UPS
- String inverter
- Solar power optimizer

#### Product validation

- Qualified for industrial applications according to the relevant tests of JEDEC47/20/22
- Please also note the application note AN2019-05 for power and thermal cycling

#### Description

- 1 – gate
- 2 – drain
- 3 – source



- Halogen-free
- Green
- Lead-free
- RoHS

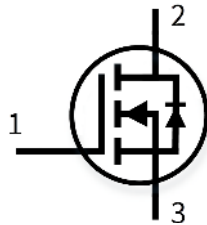

Type	Package	Marking
IMW120R020M1H	PG-TO247-3-STD-NN2.5	12M1H020

## Table of contents

	<b>Description</b> .....	1
	<b>Features</b> .....	1
	<b>Potential applications</b> .....	1
	<b>Product validation</b> .....	1
	<b>Table of contents</b> .....	2
<b>1</b>	<b>Package</b> .....	3
<b>2</b>	<b>MOSFET</b> .....	3
<b>3</b>	<b>Body diode (MOSFET)</b> .....	6
<b>4</b>	<b>Characteristics diagrams</b> .....	7
<b>5</b>	<b>Package outlines</b> .....	13
<b>6</b>	<b>Testing conditions</b> .....	14
	<b>Revision history</b> .....	15
	<b>Disclaimer</b> .....	16

## 1 Package

**Table 1** Characteristic values

Parameter	Symbol	Note or test condition	Values			Unit
			Min.	Typ.	Max.	
Storage temperature	$T_{stg}$		-55		150	°C
Soldering temperature	$T_{sold}$	wave soldering 1.6 mm (0.063 in.) from case for 10 s			260	°C
Mounting torque	$M$	M3 screw, Maximum of mounting processes: 3			0.6	Nm
Thermal resistance, junction-ambient	$R_{th(j-a)}$				62	K/W
MOSFET/body diode thermal resistance, junction-case	$R_{th(j-c)}$			0.31	0.40	K/W

## 2 MOSFET

**Table 2** Maximum rated values

Parameter	Symbol	Note or test condition	Values	Unit	
Drain-source voltage	$V_{DSS}$	$T_{vj} \geq 25\text{ °C}$	1200	V	
Continuous DC drain current for $R_{th(j-c,max)}$ , limited by $T_{vj(max)}$	$I_{DDC}$	$V_{GS} = 18\text{ V}$	$T_c = 25\text{ °C}$	98	A
			$T_c = 100\text{ °C}$	71	
Peak drain current, $t_p$ limited by $T_{vj(max)}$	$I_{DM}$	$V_{GS} = 18\text{ V}$	213	A	
Gate-source voltage, max. transient voltage <sup>1)</sup>	$V_{GS}$	$t_p \leq 0.5\text{ }\mu\text{s}$ , $D < 0.001$	-10/23	V	
Gate-source voltage, max. static voltage	$V_{GS}$		-7/20	V	
Avalanche energy, single pulse	$E_{AS}$	$I_D = 40.1\text{ A}$ , $V_{DD} = 50\text{ V}$ , $L = 0.9\text{ mH}$	721	mJ	
Avalanche energy, repetitive	$E_{AR}$	$I_D = 40.1\text{ A}$ , $V_{DD} = 50\text{ V}$ , $L = 4.5\text{ }\mu\text{H}$	3.58	mJ	
Short-circuit withstand time	$t_{SC}$	$V_{DD} \leq 800\text{ V}$ , $V_{DS,peak} < 1200\text{ V}$ , $V_{GS(on)} = 15\text{ V}$ , $T_{vj(start)} = 25\text{ °C}$	3	$\mu\text{s}$	
MOSFET dv/dt robustness	$dv/dt$	$V_{DS} = 0\dots 800\text{ V}$	150	V/ns	
Power dissipation, limited by $T_{vj(max)}$	$P_{tot}$		$T_c = 25\text{ °C}$	375	W
			$T_c = 100\text{ °C}$	188	

1) Important note: The selection of positive and negative gate-source voltages impacts the long-term behavior of the device. The design guidelines described in Application Note AN2018-09 must be considered to ensure sound operation of the device over the planned lifetime.

**Table 3 Recommended values**

Parameter	Symbol	Note or test condition	Values	Unit
Recommended turn-on gate voltage	$V_{GS(on)}$		15...18	V
Recommended turn-off gate voltage	$V_{GS(off)}$		-5...0	V

**Table 4 Characteristic values**

Parameter	Symbol	Note or test condition	Values			Unit	
			Min.	Typ.	Max.		
Drain-source on-state resistance	$R_{DS(on)}$	$I_D = 41\text{ A}$	$T_{vj} = 25\text{ °C}$ , $V_{GS(on)} = 18\text{ V}$		19	26.9	mΩ
			$T_{vj} = 100\text{ °C}$ , $V_{GS(on)} = 18\text{ V}$		25		
			$T_{vj} = 175\text{ °C}$ , $V_{GS(on)} = 18\text{ V}$		36		
			$T_{vj} = 25\text{ °C}$ , $V_{GS(on)} = 15\text{ V}$		23.7	30	
Gate-source threshold voltage	$V_{GS(th)}$	$I_D = 17.6\text{ mA}$ , $V_{DS} = V_{GS}$ (tested after 1 ms pulse at $V_{GS} = 20\text{ V}$ )	$T_{vj} = 25\text{ °C}$	3.5	4.2	5.2	V
			$T_{vj} = 175\text{ °C}$		3.6		
Zero gate-voltage drain current	$I_{DSS}$	$V_{DS} = 1200\text{ V}$ , $V_{GS} = 0\text{ V}$	$T_{vj} = 25\text{ °C}$			320	μA
			$T_{vj} = 175\text{ °C}$		5.4		
Gate leakage current	$I_{GSS}$	$V_{DS} = 0\text{ V}$	$V_{GS} = 23\text{ V}$			100	nA
			$V_{GS} = -10\text{ V}$			-100	
Forward transconductance	$g_{fs}$	$I_D = 41\text{ A}$ , $V_{DS} = 20\text{ V}$		27.4		S	
Internal gate resistance	$R_{G,int}$	$f = 1\text{ MHz}$ , $V_{AC} = 25\text{ mV}$		1.8		Ω	
Input capacitance	$C_{iss}$	$V_{DD} = 800\text{ V}$ , $V_{GS} = 0\text{ V}$ , $f = 100\text{ kHz}$ , $V_{AC} = 25\text{ mV}$		3460		pF	
Output capacitance	$C_{oss}$	$V_{DD} = 800\text{ V}$ , $V_{GS} = 0\text{ V}$ , $f = 100\text{ kHz}$ , $V_{AC} = 25\text{ mV}$		159		pF	
Reverse transfer capacitance	$C_{rss}$	$V_{DD} = 800\text{ V}$ , $V_{GS} = 0\text{ V}$ , $f = 100\text{ kHz}$ , $V_{AC} = 25\text{ mV}$		23		pF	
$C_{oss}$ stored energy	$E_{oss}$	$V_{DD} = 800\text{ V}$ , $V_{GS} = 0\text{ V}$ , $f = 100\text{ kHz}$ , $V_{AC} = 25\text{ mV}$		65		μJ	
Total gate charge	$Q_G$	$V_{DD} = 800\text{ V}$ , $I_D = 41\text{ A}$ , $V_{GS} = 0/18\text{ V}$ , turn-on pulse		109		nC	
Plateau gate charge	$Q_{GS(pl)}$	$V_{DD} = 800\text{ V}$ , $I_D = 41\text{ A}$ , $V_{GS} = 0/18\text{ V}$ , turn-on pulse		27.1		nC	
Gate-to-drain charge	$Q_{GD}$	$V_{DD} = 800\text{ V}$ , $I_D = 41\text{ A}$ , $V_{GS} = 0/18\text{ V}$ , turn-on pulse		21.8		nC	

(table continues...)

**Table 4 (continued) Characteristic values**

Parameter	Symbol	Note or test condition	Values			Unit
			Min.	Typ.	Max.	
Turn-on delay time	$t_{d(on)}$	$V_{DD} = 800\text{ V}, I_D = 41\text{ A},$ $V_{GS} = 0/18\text{ V},$ $R_{GS(on)} = 2\ \Omega,$ $R_{GS(off)} = 2\ \Omega, L_\sigma = 15\text{ nH},$ diode: body diode at $V_{GS} = 0\text{ V}$	$T_{vj} = 25\text{ }^\circ\text{C}$		23	ns
			$T_{vj} = 175\text{ }^\circ\text{C}$		21	
Rise time	$t_r$	$V_{DD} = 800\text{ V}, I_D = 41\text{ A},$ $V_{GS} = 0/18\text{ V},$ $R_{GS(on)} = 2\ \Omega,$ $R_{GS(off)} = 2\ \Omega, L_\sigma = 15\text{ nH},$ diode: body diode at $V_{GS} = 0\text{ V}$	$T_{vj} = 25\text{ }^\circ\text{C}$		21.9	ns
			$T_{vj} = 175\text{ }^\circ\text{C}$		28.2	
Turn-off delay time	$t_{d(off)}$	$V_{DD} = 800\text{ V}, I_D = 41\text{ A},$ $V_{GS} = 0/18\text{ V},$ $R_{GS(on)} = 2\ \Omega,$ $R_{GS(off)} = 2\ \Omega, L_\sigma = 15\text{ nH},$ diode: body diode at $V_{GS} = 0\text{ V}$	$T_{vj} = 25\text{ }^\circ\text{C}$		29	ns
			$T_{vj} = 175\text{ }^\circ\text{C}$		32	
Fall time	$t_f$	$V_{DD} = 800\text{ V}, I_D = 41\text{ A},$ $V_{GS} = 0/18\text{ V},$ $R_{GS(on)} = 2\ \Omega,$ $R_{GS(off)} = 2\ \Omega, L_\sigma = 15\text{ nH},$ diode: body diode at $V_{GS} = 0\text{ V}$	$T_{vj} = 25\text{ }^\circ\text{C}$		16.5	ns
			$T_{vj} = 175\text{ }^\circ\text{C}$		16.4	
Turn-on energy	$E_{on}$	$V_{DD} = 800\text{ V}, I_D = 41\text{ A},$ $V_{GS} = 0/18\text{ V},$ $R_{GS(on)} = 2\ \Omega,$ $R_{GS(off)} = 2\ \Omega, L_\sigma = 15\text{ nH},$ diode: body diode at $V_{GS} = 0\text{ V}$	$T_{vj} = 25\text{ }^\circ\text{C}$		1050	$\mu\text{J}$
			$T_{vj} = 175\text{ }^\circ\text{C}$		1273	
Turn-off energy	$E_{off}$	$V_{DD} = 800\text{ V}, I_D = 41\text{ A},$ $V_{GS} = 0/18\text{ V},$ $R_{GS(on)} = 2\ \Omega,$ $R_{GS(off)} = 2\ \Omega, L_\sigma = 15\text{ nH},$ diode: body diode at $V_{GS} = 0\text{ V}$	$T_{vj} = 25\text{ }^\circ\text{C}$		400	$\mu\text{J}$
			$T_{vj} = 175\text{ }^\circ\text{C}$		444	
Total switching energy	$E_{tot}$	$V_{DD} = 800\text{ V}, I_D = 41\text{ A},$ $V_{GS} = 0/18\text{ V},$ $R_{GS(on)} = 2\ \Omega,$ $R_{GS(off)} = 2\ \Omega, L_\sigma = 15\text{ nH},$ diode: body diode at $V_{GS} = 0\text{ V}$	$T_{vj} = 25\text{ }^\circ\text{C}$		1627	$\mu\text{J}$
			$T_{vj} = 175\text{ }^\circ\text{C}$		2194	
Virtual junction temperature	$T_{vj}$			-55	175	$^\circ\text{C}$

**3 Body diode (MOSFET)**

*Note: For optimum lifetime and reliability, Infineon recommends operating conditions that do not exceed 80% of the maximum ratings stated in this datasheet.*

*The chip technology was characterized up to 200 kV/μs. The measured dv/dt was limited by measurement test setup and package.*

*Dynamic test circuit see Fig. F.*

**3 Body diode (MOSFET)**

**Table 5 Maximum rated values**

Parameter	Symbol	Note or test condition	Values	Unit	
Drain-source voltage	$V_{DSS}$	$T_{vj} \geq 25\text{ °C}$	1200	V	
Continuous reverse drain current for $R_{th(j-c,max)}$ , limited by $T_{vj(max)}$	$I_{SDC}$	$V_{GS} = 0\text{ V}$	$T_c = 25\text{ °C}$	94	A
			$T_c = 100\text{ °C}$	58	
Peak reverse drain current, $t_p$ limited by $T_{vj(max)}$	$I_{SM}$	$V_{GS} = 0\text{ V}$	213	A	

**Table 6 Characteristic values**

Parameter	Symbol	Note or test condition	Values			Unit	
			Min.	Typ.	Max.		
Drain-source reverse voltage	$V_{SD}$	$I_{SD} = 41\text{ A}, V_{GS} = 0\text{ V}$	$T_{vj} = 25\text{ °C}$		3.8	5	V
			$T_{vj} = 100\text{ °C}$		3.7		
			$T_{vj} = 175\text{ °C}$		3.6		
MOSFET forward recovery charge	$Q_{fr}$	$V_{DD} = 800\text{ V}, I_{SD} = 41\text{ A}, V_{GS} = 0\text{ V}, di_{SD}/dt = 3000\text{ A}/\mu\text{s}, Q_{fr}$ includes also $Q_C$	$T_{vj} = 25\text{ °C}$		340		nC
			$T_{vj} = 175\text{ °C}$		622		
MOSFET peak forward recovery current	$I_{frm}$	$V_{DD} = 800\text{ V}, I_{SD} = 41\text{ A}, V_{GS} = 0\text{ V}, di_{SD}/dt = 3000\text{ A}/\mu\text{s}, Q_{fr}$ includes also $Q_C$	$T_{vj} = 25\text{ °C}$		17		A
			$T_{vj} = 175\text{ °C}$		21		
MOSFET forward recovery energy	$E_{fr}$	$V_{DD} = 800\text{ V}, I_{SD} = 41\text{ A}, V_{GS} = 0\text{ V}, di_{SD}/dt = 3000\text{ A}/\mu\text{s}, Q_{fr}$ includes also $Q_C$	$T_{vj} = 25\text{ °C}$		177		μJ
			$T_{vj} = 175\text{ °C}$		477		
Virtual junction temperature	$T_{vj}$		-55		175	°C	

## 4 Characteristics diagrams

### Reverse bias safe operating area (RBSOA)

$$I_{DS} = f(V_{DS})$$

$$T_{vj} \leq 175\text{ °C}, V_{GS} = 0/18\text{ V}, T_c = 25\text{ °C}$$

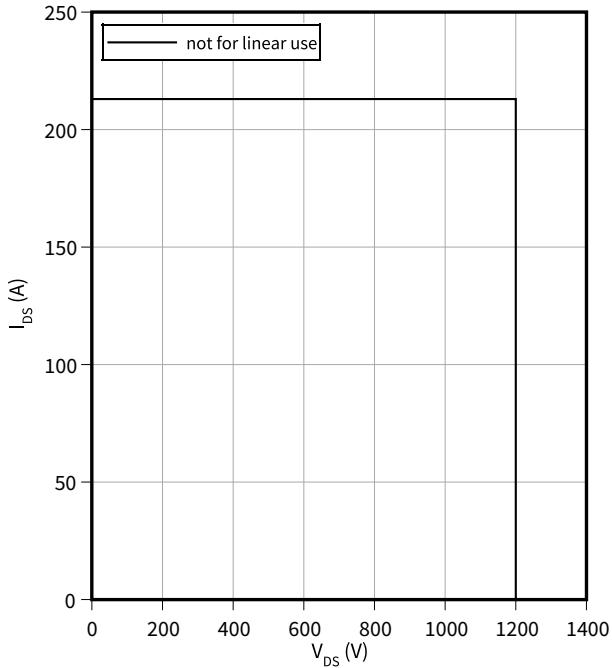

### Power dissipation as a function of case temperature limited by bond wire

$$P_{tot} = f(T_c)$$

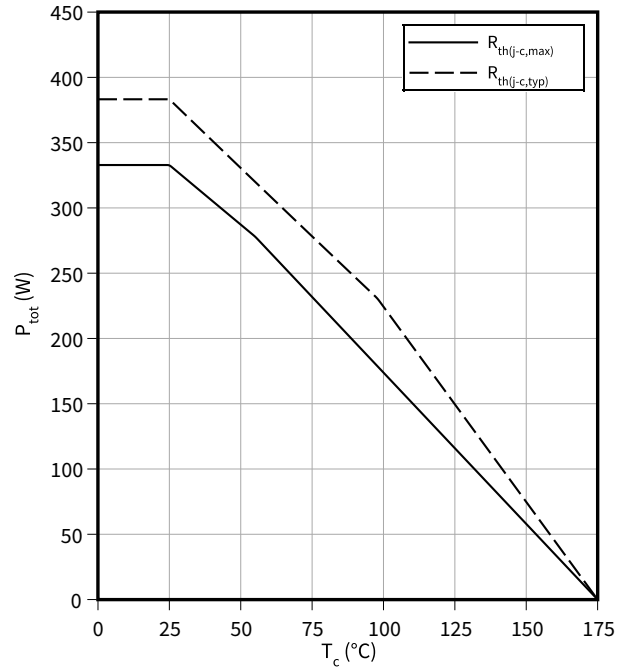

### Maximum DC drain to source current as a function of case temperature limited by bond wire

$$I_{DS} = f(T_c)$$

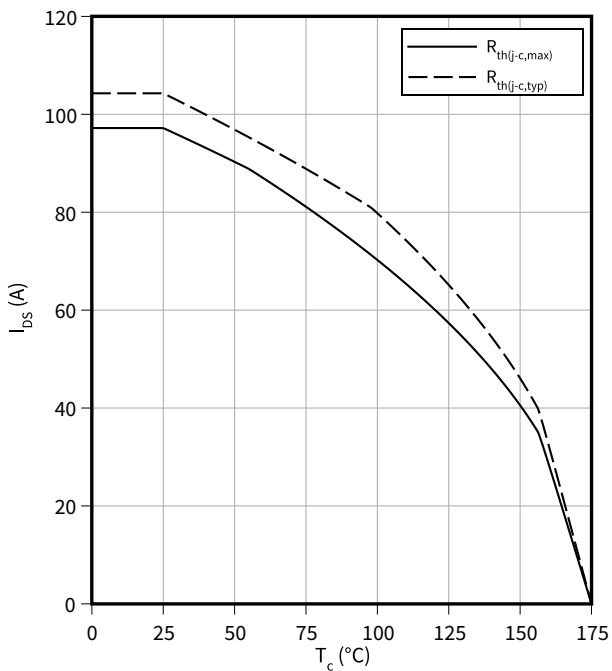

### Maximum source to drain current as a function of case temperature limited by bond wire

$$I_{SD} = f(T_c)$$

$$V_{GS} = 0\text{ V}$$

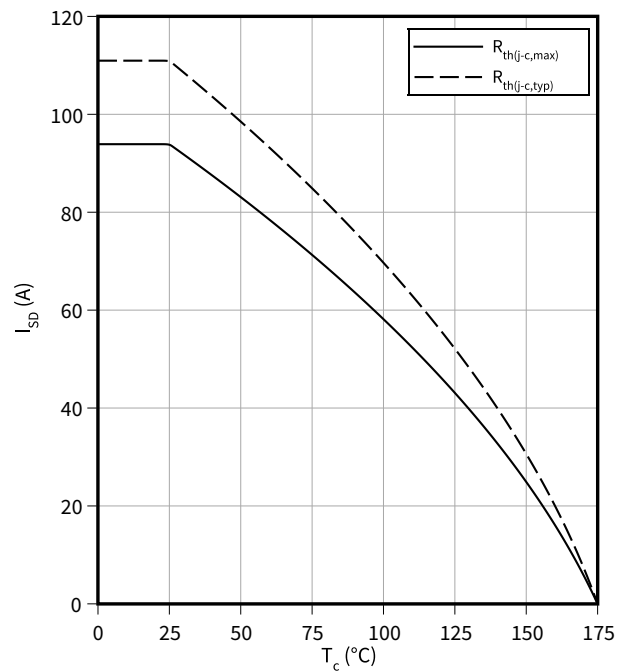

4 Characteristics diagrams

**Typical transfer characteristic**

$I_{DS} = f(V_{GS})$   
 $V_{DS} = 20 \text{ V}, t_p = 20 \mu\text{s}$

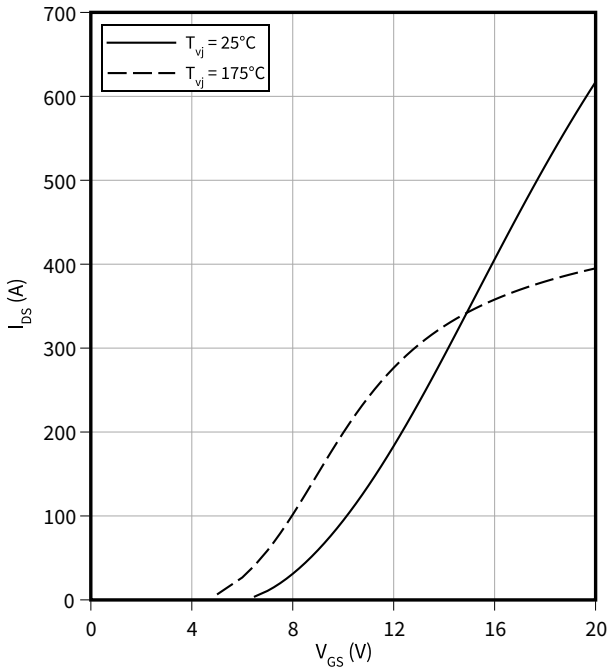

**Typical gate-source threshold voltage as a function of junction temperature**

$V_{GS(th)} = f(T_{vj})$   
 $I_D = 17.6 \text{ mA}$

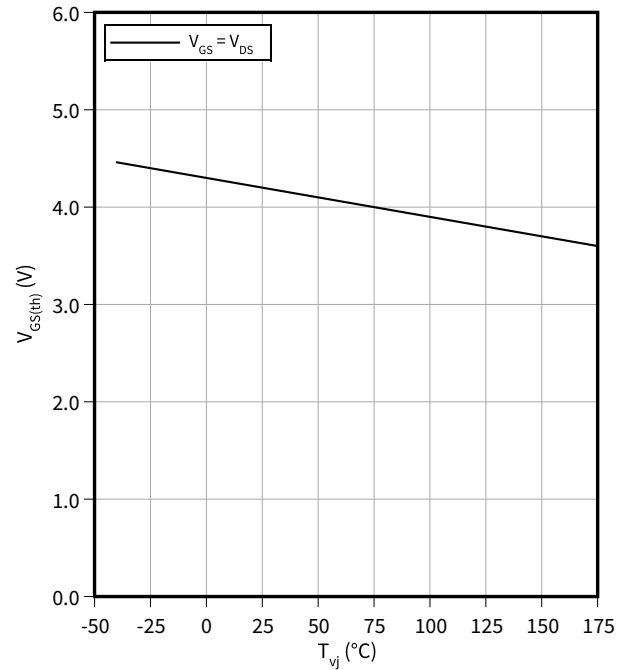

**Typical output characteristic,  $V_{GS}$  as parameter**

$I_{DS} = f(V_{DS})$   
 $T_{vj} = 25^\circ\text{C}, t_p = 20 \mu\text{s}$

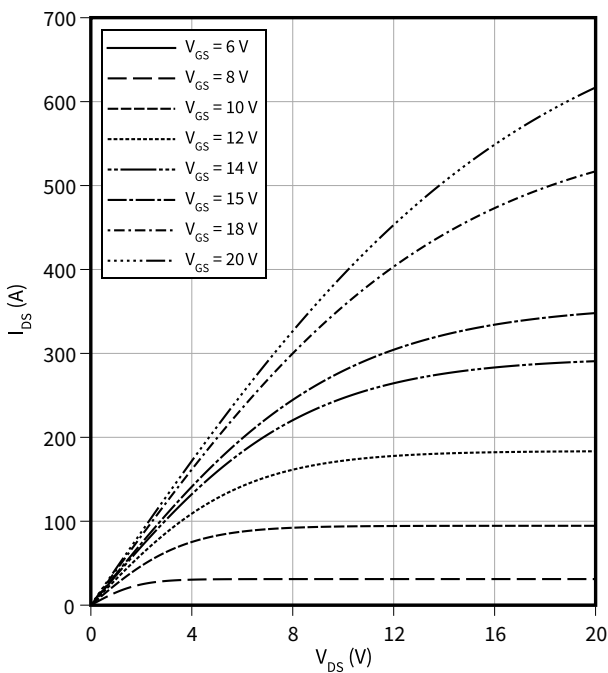

**Typical output characteristic,  $V_{GS}$  as parameter**

$I_{DS} = f(V_{DS})$   
 $T_{vj} = 175^\circ\text{C}, t_p = 20 \mu\text{s}$

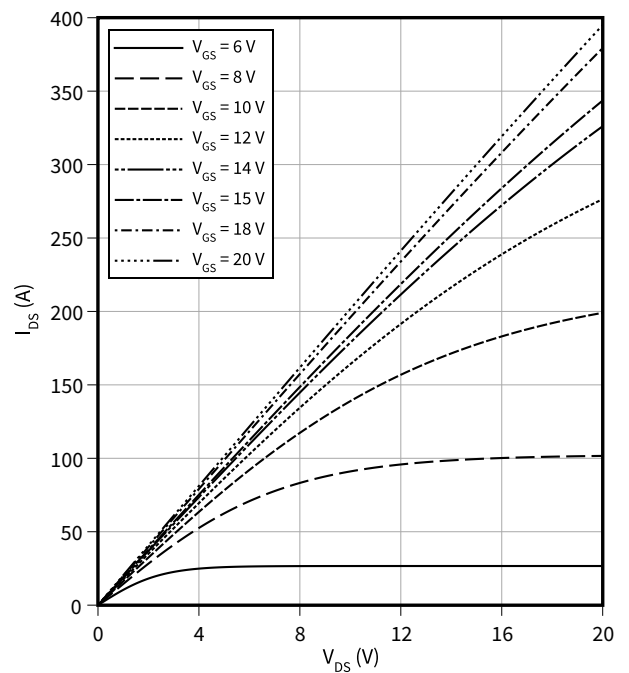



4 Characteristics diagrams

**Typical on-state resistance as a function of junction temperature**

$R_{DS(on)} = f(T_{vj})$   
 $I_D = 41 \text{ A}$

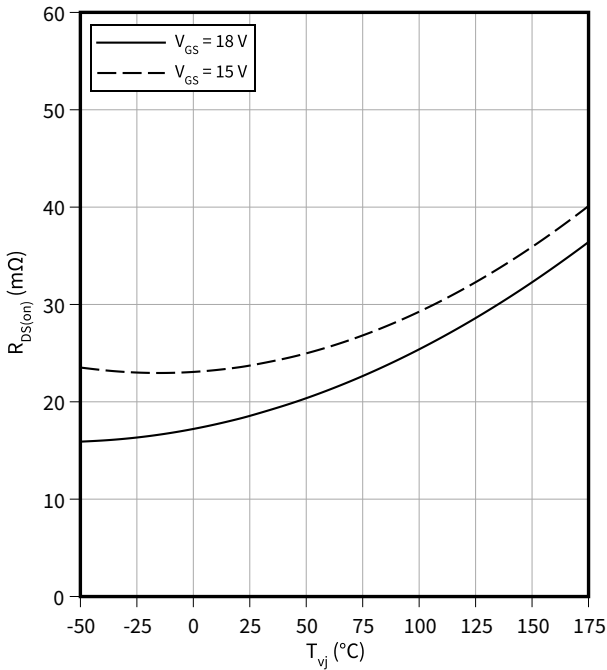

**Typical gate charge**

$V_{GS} = f(Q_G)$   
 $I_D = 41 \text{ A}, V_{DS} = 800 \text{ V}$

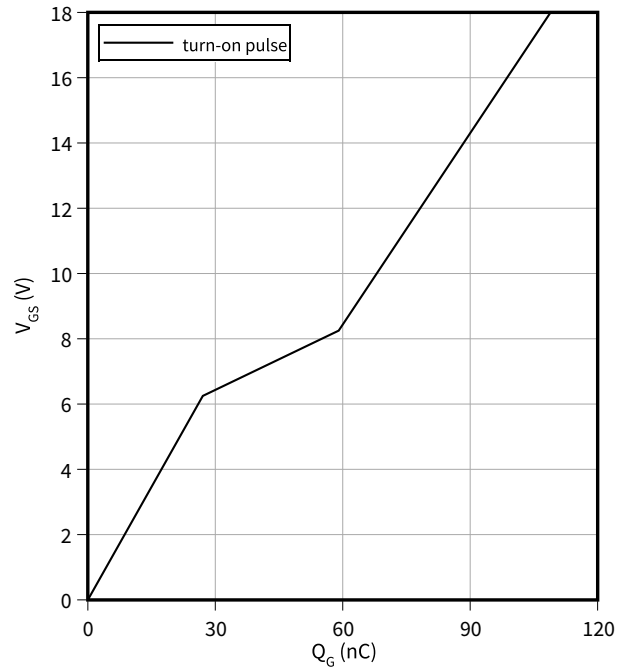

**Typical capacitance as a function of drain-source voltage**

$C = f(V_{DS})$   
 $f = 100 \text{ kHz}, V_{GS} = 0 \text{ V}$

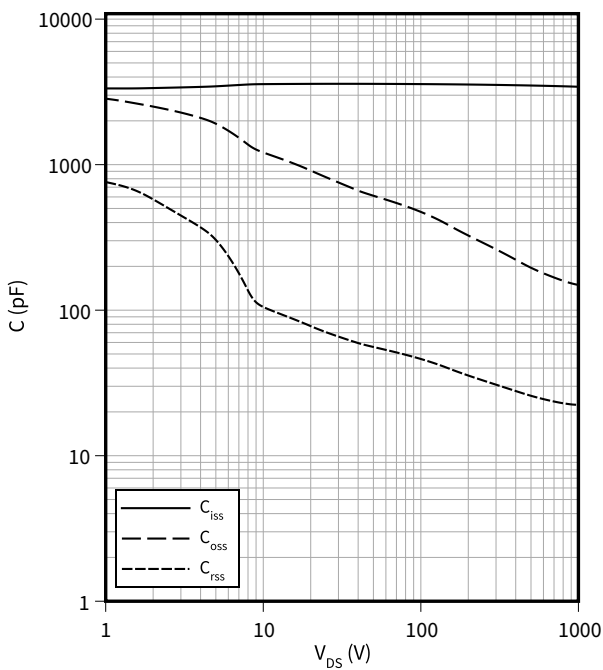

**Typical reverse drain voltage as function of junction temperature**

$V_{SD} = f(T_{vj})$   
 $I_{SD} = 41 \text{ A}, V_{GS} = 0 \text{ V}$

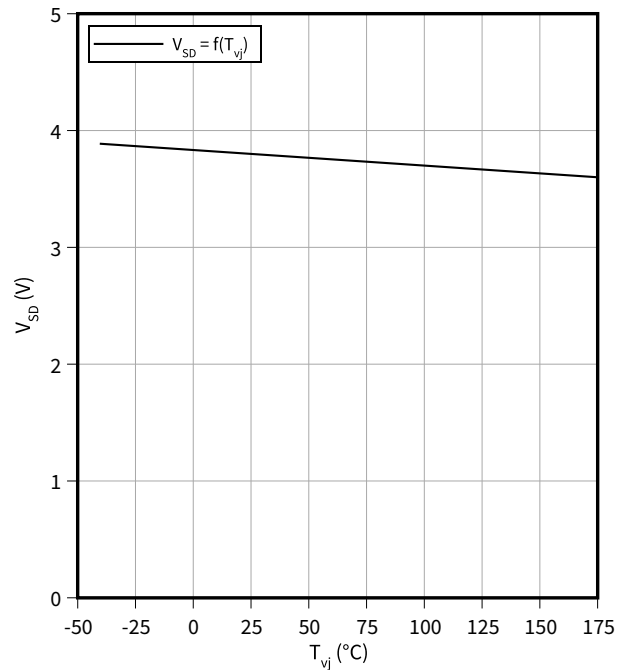

4 Characteristics diagrams

**Typical reverse drain current as function of reverse drain voltage,  $V_{GS}$  as parameter**

$I_{SD} = f(V_{SD})$   
 $T_{vj} = 175\text{ °C}$ ,  $t_p = 20\text{ }\mu\text{s}$

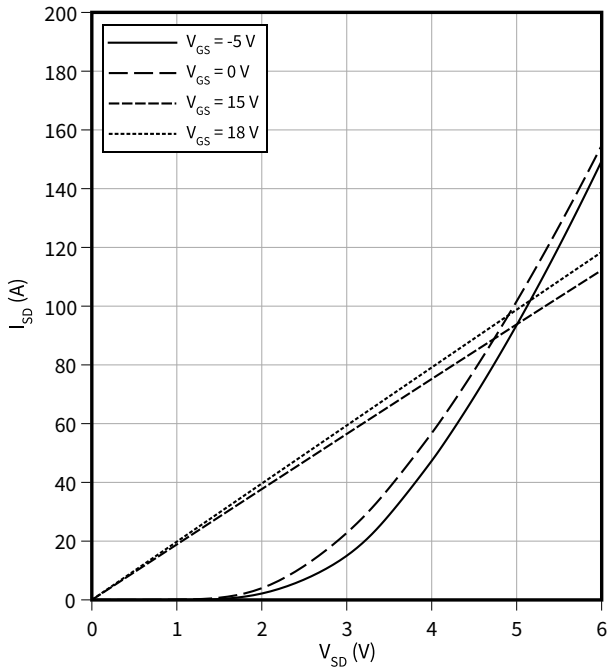

**Typical reverse drain current as function of reverse drain voltage,  $V_{GS}$  as parameter**

$I_{SD} = f(V_{SD})$   
 $T_{vj} = 25\text{ °C}$ ,  $t_p = 20\text{ }\mu\text{s}$

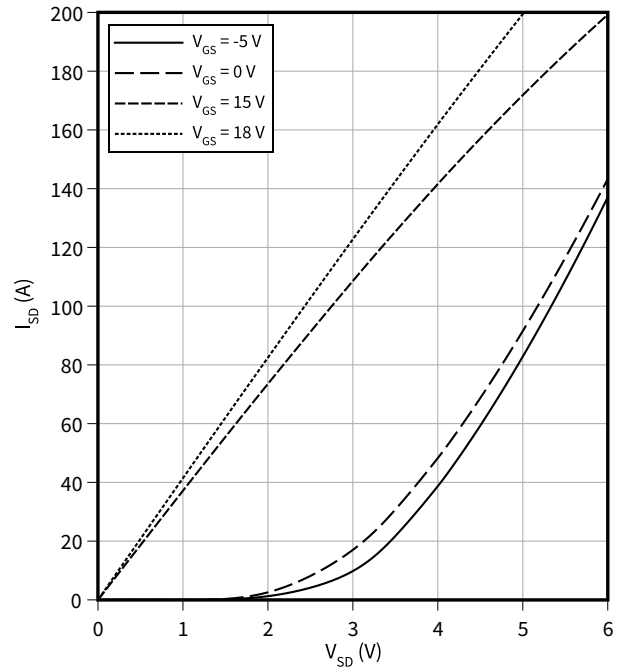

**Typical switching energy as a function of junction temperature, test circuit in Fig. F, 2nd device own body diode:  $V_{GS} = 0\text{ V}$**

$E = f(T_{vj})$   
 $V_{GS} = 0/18\text{ V}$ ,  $I_D = 41\text{ A}$ ,  $R_{G,ext} = 2\text{ }\Omega$ ,  $V_{DD} = 800\text{ V}$

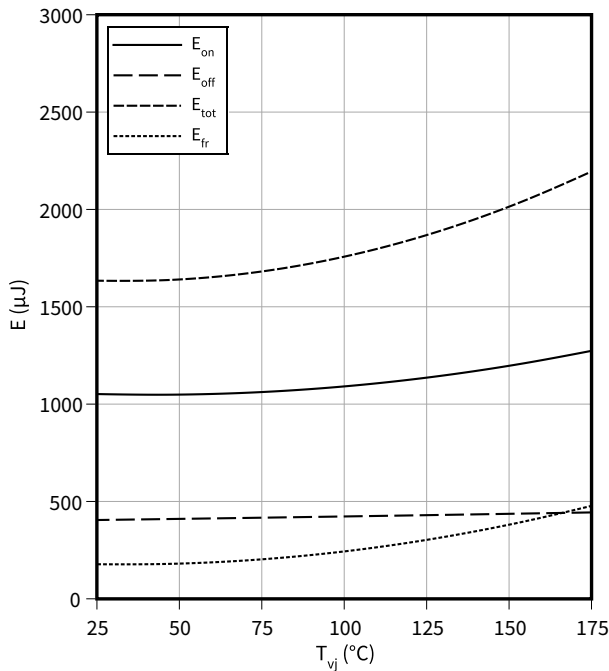

**Typical switching energy as a function of drain current, test circuit in Fig. F, 2nd device own body diode:  $V_{GS} = 0\text{ V}$**

$E = f(I_D)$   
 $V_{GS} = 0/18\text{ V}$ ,  $T_{vj} = 175\text{ °C}$ ,  $R_{G,ext} = 2\text{ }\Omega$ ,  $V_{DD} = 800\text{ V}$

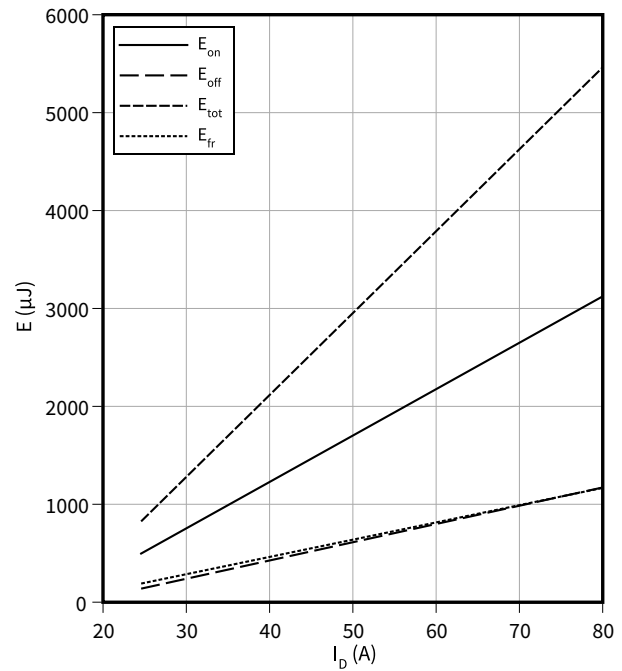

4 Characteristics diagrams

**Typical switching energy losses as a function of gate resistance, test circuit in Fig. F, 2nd device own body diode:  $V_{GS} = 0\text{ V}$**

$E = f(R_{G,ext})$

$V_{GS} = 0/18\text{ V}$ ,  $I_D = 41\text{ A}$ ,  $T_{vj} = \text{°C}$ ,  $V_{DD} = 800\text{ V}$

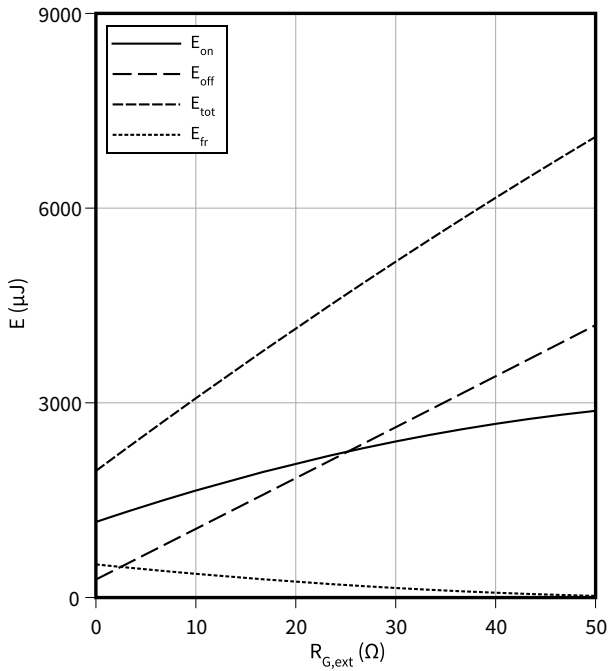

**Typical switching times as a function of gate resistance, test circuit in Fig. F, 2nd device own body diode:  $V_{GS} = 0\text{ V}$**

$t = f(R_{G,ext})$

$V_{GS} = 0/18\text{ V}$ ,  $I_D = 41\text{ A}$ ,  $T_{vj} = 175\text{ °C}$ ,  $V_{DD} = 800\text{ V}$

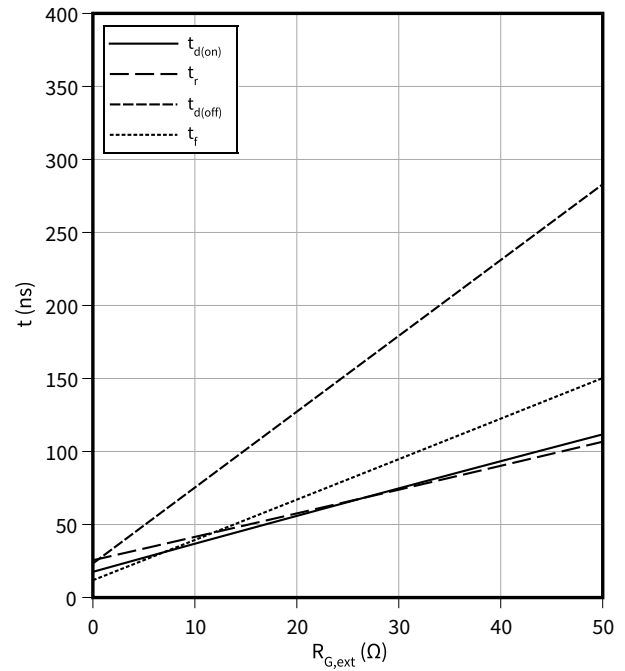

**Typical reverse recovery charge as a function of reverse drain current slope, test circuit in Fig. F, 2nd device own body diode:  $V_{GS} = 0\text{ V}$**

$Q_{fr} = f(di_{SD}/dt)$

$V_{GS} = 0/18\text{ V}$ ,  $I_{SD} = 41\text{ A}$ ,  $V_{DD} = 800\text{ V}$

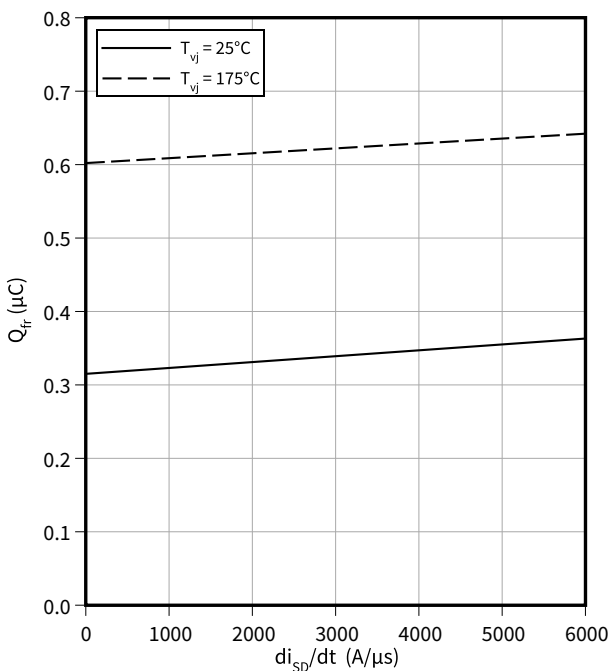

**Typical reverse recovery current as a function of reverse drain current slope, test circuit in Fig. F, 2nd device own body diode:  $V_{GS} = 0\text{ V}$**

$I_{frm} = f(di_{SD}/dt)$

$V_{GS} = 0/18\text{ V}$ ,  $I_{SD} = 41\text{ A}$ ,  $V_{DD} = 800\text{ V}$

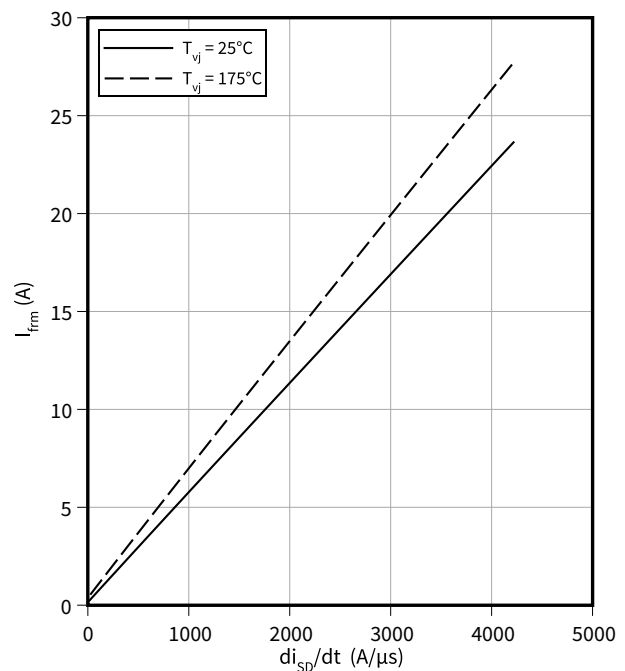

4 Characteristics diagrams

**Typical switching energy losses as a function of dead time / blanking time, test circuit in Fig. F, 2nd device own body diode:  $V_{GS} = -5$  V**

$$E = f(t_{dead})$$

$V_{GS} = -5/18$  V,  $I_D = 41$  A,  $T_{vj} = 175$  °C,  $V_{DD} = 800$  V

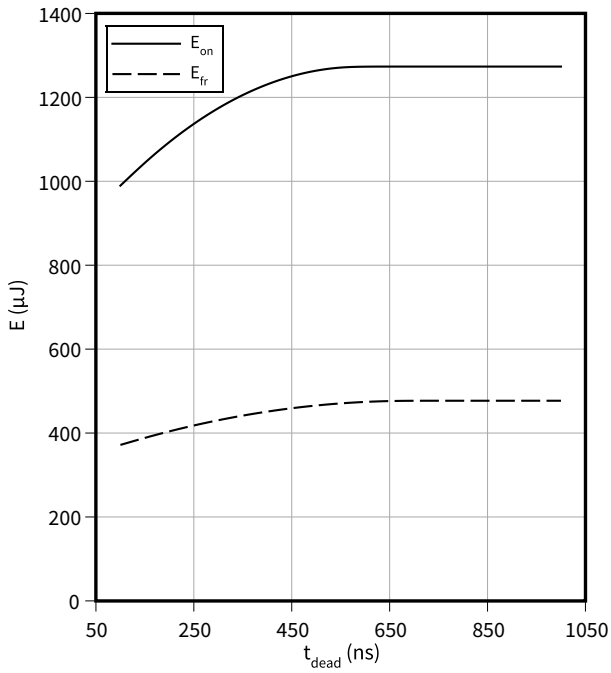

**Max. transient thermal impedance (MOSFET/diode)**

$$Z_{th(j-c),max} = f(t_p)$$

$$D = t_p/T$$

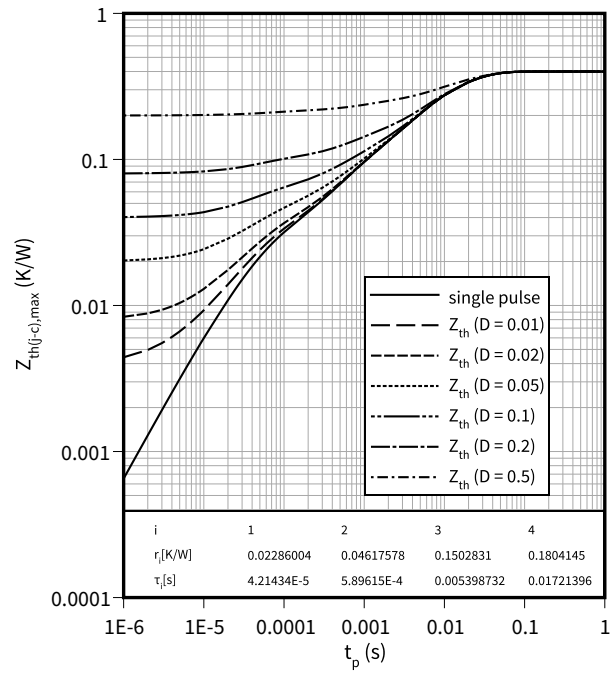

i	1	2	3	4
$r_f$ [K/W]	0.02286004	0.04617578	0.1502831	0.1804145
$\tau_f$ [s]	4.21434E-5	5.89615E-4	0.005398732	0.01721396

5 Package outlines

PG-TO247-3-STD-NN2.5

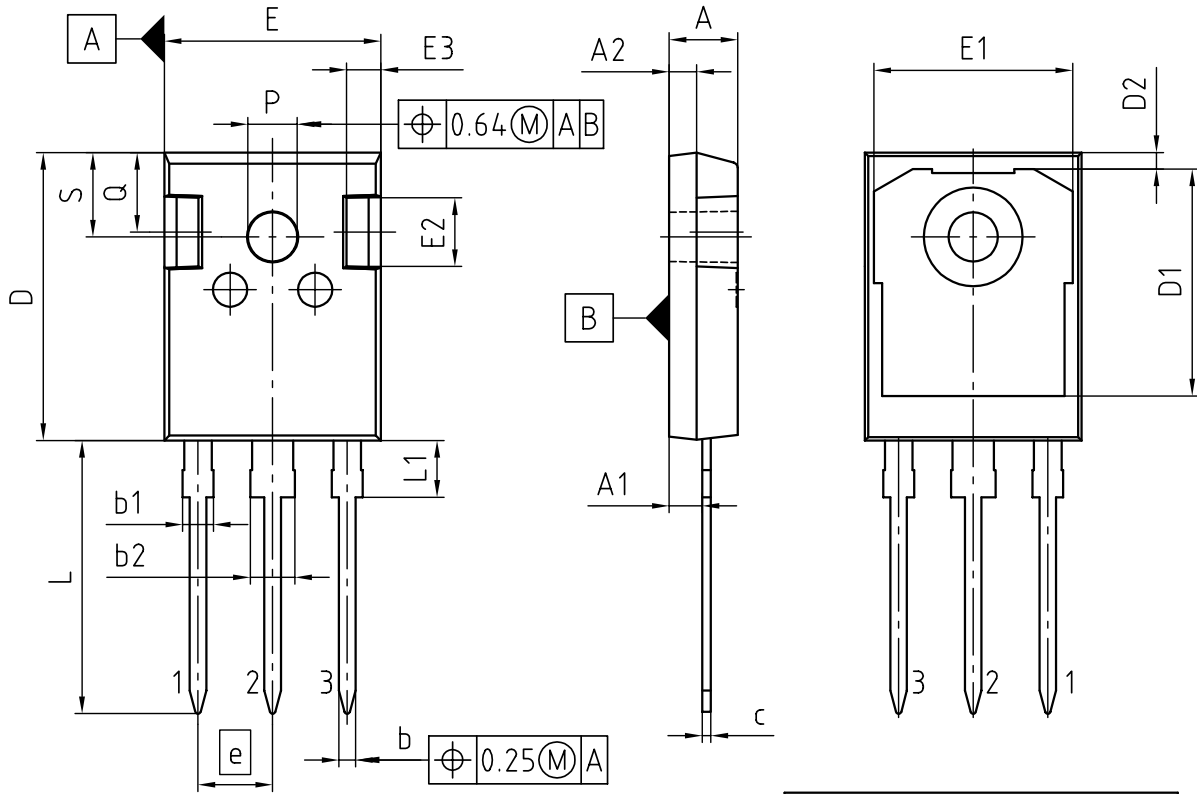

PACKAGE - GROUP NUMBER: PG-TO247-3-U06		
DIMENSIONS	MILLIMETERS	
	MIN.	MAX.
A	4.83	5.21
A1	2.27	2.54
A2	1.85	2.16
b	1.07	1.33
b1	1.90	2.41
b2	2.87	3.38
c	0.55	0.68
D	20.80	21.10
D1	16.25	17.65
D2	0.95	1.35
E	15.70	16.13
E1	13.10	14.15
E2	3.68	5.10
E3	1.00	2.60
e	5.44	
N	3	
L	19.80	20.32
L1	4.10	4.47
øP	3.50	3.70
Q	5.49	6.00
S	6.04	6.30

NOTE:  
DIMENSIONS DO NOT INCLUDE MOLDFLASH; PROTRUSION OR GATE BURRS

Figure 1

## 6 Testing conditions

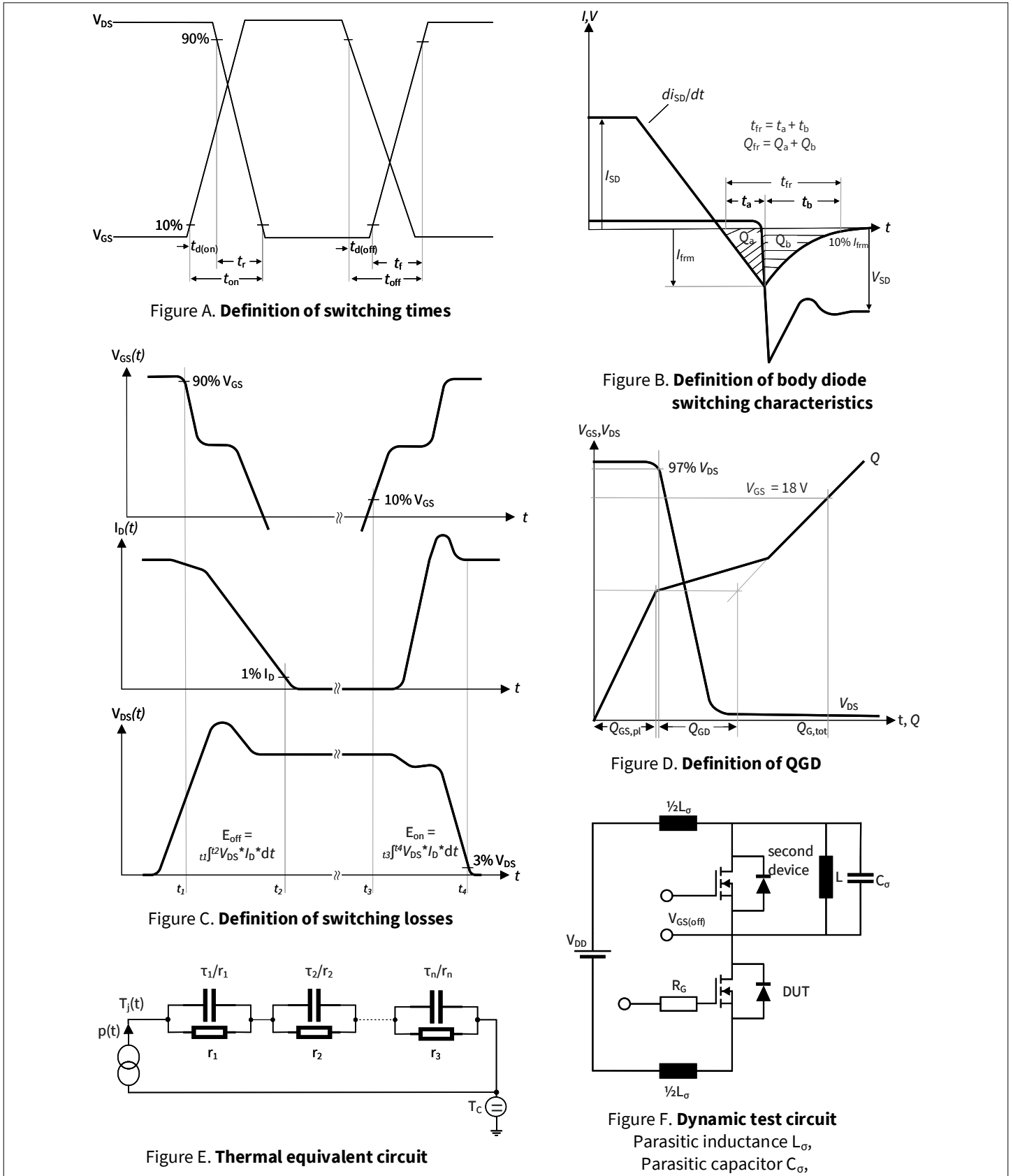

Figure 2

## Revision history

Document revision	Date of release	Description of changes
1.00	2022-02-02	Final datasheet
1.10	2022-08-12	Change of test condition of dynamic capacitances in Table 4, "Characteristic values" ( $C_{iss}$ , $C_{oss}$ , $C_{rss}$ ): $V_{DD} = 25\text{ V}$ to $V_{DD} = 800\text{ V}$ Correction of unit of "Input capacitance" $C_{iss}$ from nF to pF Change of $V_{GS}$ "Gate-source voltage, max. static voltage" in Table 2, "Maximum rated values" from -5/20 V to -7/20 V Editorial changes in "Features" on page 1 Editorial changes in "Package" on page 1 Correction of unit of x-axis at diagram "Max. transient thermal impedance (MOSFET/diode)" from $\mu\text{s}$ to s, on page 13 Correction of diagram "Typical reverse drain current as a function of reverse drain voltage, $V_{GS}$ as parameter", on page 11
1.20	2023-02-20	Correction of $I_{DSS}$ in table 4 on page 4 Editorial changes
1.30	2023-05-08	Correction of gate charge values in Table 4

## Trademarks

All referenced product or service names and trademarks are the property of their respective owners.

**Edition 2023-05-08**

**Published by**

**Infineon Technologies AG**

**81726 Munich, Germany**

**© 2023 Infineon Technologies AG**

**All Rights Reserved.**

**Do you have a question about any aspect of this document?**

**Email: [erratum@infineon.com](mailto:erratum@infineon.com)**

**Document reference**

**IFX-ABB900-004**

## Important notice

The information given in this document shall in no event be regarded as a guarantee of conditions or characteristics ("Beschaffheitsgarantie").

With respect to any examples, hints or any typical values stated herein and/or any information regarding the application of the product, Infineon Technologies hereby disclaims any and all warranties and liabilities of any kind, including without limitation warranties of non-infringement of intellectual property rights of any third party.

In addition, any information given in this document is subject to customer's compliance with its obligations stated in this document and any applicable legal requirements, norms and standards concerning customer's products and any use of the product of Infineon Technologies in customer's applications.

The data contained in this document is exclusively intended for technically trained staff. It is the responsibility of customer's technical departments to evaluate the suitability of the product for the intended application and the completeness of the product information given in this document with respect to such application.

Please note that this product is not qualified according to the AEC Q100 or AEC Q101 documents of the Automotive Electronics Council.

## Warnings

Due to technical requirements products may contain dangerous substances. For information on the types in question please contact your nearest Infineon Technologies office.

Except as otherwise explicitly approved by Infineon Technologies in a written document signed by authorized representatives of Infineon Technologies, Infineon Technologies' products may not be used in any applications where a failure of the product or any consequences of the use thereof can reasonably be expected to result in personal injury.