



# 74LCX374

## Low Voltage Octal D-Type Flip-Flop with 5V Tolerant Inputs and Outputs

### Features

- 5V tolerant inputs and outputs
- 2.3V–3.6V  $V_{CC}$  specifications provided
- 8.5ns  $t_{PD}$  max ( $V_{CC} = 3.3V$ ), 10 $\mu$ A  $I_{CC}$  max
- Power-down high impedance inputs and outputs
- Supports live insertion/withdrawal<sup>(1)</sup>
- $\pm 24mA$  output drive ( $V_{CC} = 3.0V$ )
- Implements proprietary noise/EMI reduction circuitry
- Latch-up performance exceeds JEDEC 78 conditions
- ESD performance
  - Human Body Model > 2000V
  - Machine Model > 200V
- Leadless DQFN package

### Note:

1. To ensure the high impedance state during power up or down,  $\overline{OE}$  should be tied to  $V_{CC}$  through a pull-up resistor: the minimum value of the resistor is determined by the current-sourcing capability of the driver.

### General Description

The LCX374 consists of eight D-type flip-flops featuring separate D-type inputs for each flip-flop and 3-STATE outputs for bus-oriented applications. A buffered clock (CP) and Output Enable ( $\overline{OE}$ ) are common to all flip-flops. The LCX374 is designed for low voltage applications with capability of interfacing to a 5V signal environment.

The LCX374 is fabricated with an advanced CMOS technology to achieve high speed operation while maintaining CMOS low power dissipation.

### Ordering Information

Order Number	Package Number	Package Description
74LCX374WM	M20B	20-Lead Small Outline Integrated Circuit (SOIC), JEDEC MS-013, 0.300" Wide
74LCX374SJ	M20D	20-Lead Small Outline Package (SOP), EIAJ TYPE II, 5.3mm Wide
74LCX374BQX <sup>(2)</sup>	MLP20B	20-Terminal Depopulated Quad Very-Thin Flat Pack No Leads (DQFN), JEDEC MO-241, 2.5 x 4.5mm
74LCX374MSA	MSA20	20-Lead Shrink Small Outline Package (SSOP), JEDEC MO-150, 5.3mm Wide
74LCX374MTC	MTC20	20-Lead Thin Shrink Small Outline Package (TSSOP), JEDEC MO-153, 4.4mm Wide

### Note:

2. DQFN package available in Tape and Reel only.

Device also available in Tape and Reel. Specify by appending suffix letter "X" to the ordering number.



All packages are lead free per JEDEC: J-STD-020B standard.

## Connection Diagrams

Pin Assignments for SOIC, SOP, SSOP, TSSOP

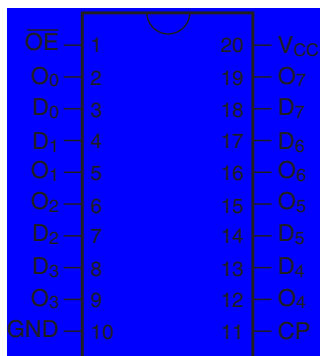

Pad Assignments for DQFN

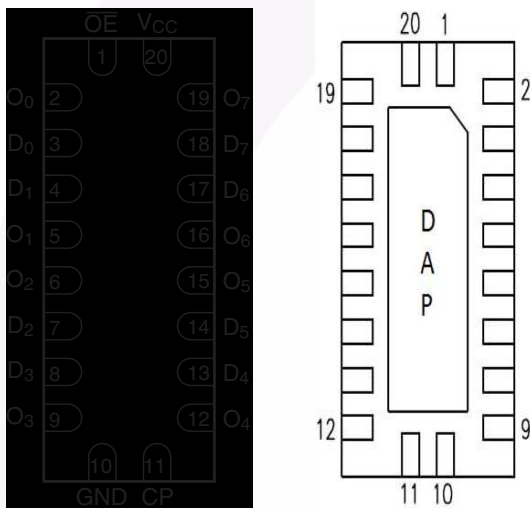

(Top View)

(Bottom View)

## Pin Description

Pin Names	Description
D <sub>0</sub> –D <sub>7</sub>	Data Inputs
CP	Clock Pulse Input
$\overline{OE}$	Output Enable Input
O <sub>0</sub> –O <sub>7</sub>	3-STATE Outputs
DAP	No Connect

Note: DAP (Die Attach Pad)

## Logic Symbol

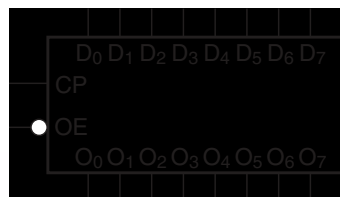

## Truth Table

Inputs			Outputs
D <sub>n</sub>	CP	$\overline{OE}$	O <sub>n</sub>
H	↗	L	H
L	↗	L	L
X	L	L	O <sub>0</sub>
X	X	H	Z

H = HIGH Voltage Level

L = LOW Voltage Level

X = Immaterial

Z = High Impedance

↗ = LOW-to-HIGH Transition

O<sub>0</sub> = Previous O<sub>0</sub> before HIGH-to-LOW of CP

## Functional Description

The LCX374 consists of eight edge-triggered flip-flops with individual D-type inputs and 3-STATE true outputs. The buffered clock and buffered Output Enable are common to all flip-flops. The eight flip-flops will store the state of their individual D inputs that meet the setup and hold time requirements on the LOW-to-HIGH Clock (CP) transition. With the Output Enable ( $\overline{OE}$ ) LOW, the contents of the eight flip-flops are available at the outputs. When the  $\overline{OE}$  is HIGH, the outputs go to the high impedance state. Operation of the  $\overline{OE}$  input does not affect the state of the flip-flops.

Please note that this diagram is provided only for the understanding of logic operations and should not be used to estimate propagation delays.

### Logic Diagram

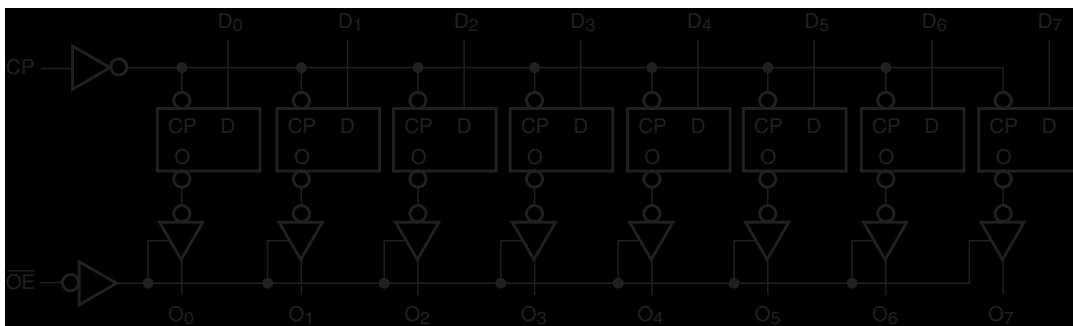

Please note that this diagram is provided only for the understanding of logic operations and should not be used to estimate propagation delays.



## Absolute Maximum Ratings

Stresses exceeding the absolute maximum ratings may damage the device. The device may not function or be operable above the recommended operating conditions and stressing the parts to these levels is not recommended. In addition, extended exposure to stresses above the recommended operating conditions may affect device reliability. The absolute maximum ratings are stress ratings only.

Symbol	Parameter	Conditions	Value	Units
$V_{CC}$	Supply Voltage		-0.5 to +7.0	V
$V_I$	DC Input Voltage		-0.5 to +7.0	V
$V_O$	DC Output Voltage	Output in 3-STATE	-0.5 to +7.0	V
		Output in HIGH or LOW State <sup>(3)</sup>	-0.5 to $V_{CC} + 0.5$	
$I_{IK}$	DC Input Diode Current	$V_I < \text{GND}$	-50	mA
$I_{OK}$	DC Output Diode Current	$V_O < \text{GND}$	-50	mA
		$V_O > V_{CC}$	+50	
$I_O$	DC Output Source/Sink Current		$\pm 50$	mA
$I_{CC}$	DC Supply Current per Supply Pin		$\pm 100$	mA
$I_{GND}$	DC Ground Current per Ground Pin		$\pm 100$	mA
$T_{STG}$	Storage Temperature		-65 to +150	°C

## Recommended Operating Conditions<sup>(4)</sup>

The Recommended Operating Conditions table defines the conditions for actual device operation. Recommended operating conditions are specified to ensure optimal performance to the datasheet specifications. Fairchild does not recommend exceeding them or designing to absolute maximum ratings.

Symbol	Parameter	Conditions	Min.	Max.	Units
$V_{CC}$	Supply Voltage	Operating	2.0	3.6	V
		Data Retention	1.5	3.6	
$V_I$	Input Voltage		0	5.5	V
$V_O$	Output Voltage	HIGH or LOW State	0	$V_{CC}$	V
		3-STATE	0	5.5	
$I_{OH}/I_{OL}$	Output Current	$V_{CC} = 3.0\text{V}-3.6\text{V}$		$\pm 24$	mA
		$V_{CC} = 2.7\text{V}-3.0\text{V}$		$\pm 12$	
		$V_{CC} = 2.3\text{V}-2.7\text{V}$		$\pm 8$	
$T_A$	Free-Air Operating Temperature		-40	85	°C
$\Delta t/\Delta V$	Input Edge Rate	$V_{IN} = 0.8\text{V}-2.0\text{V}, V_{CC} = 3.0\text{V}$	0	10	ns/V

### Notes:

- $I_O$  Absolute Maximum Rating must be observed.
- Unused inputs must be held HIGH or LOW. They may not float.

## DC Electrical Characteristics

Symbol	Parameter	V <sub>CC</sub> (V)	Conditions	T <sub>A</sub> = -40°C to +85°C		Units
				Min.	Max.	
V <sub>IH</sub>	HIGH Level Input Voltage	2.3–2.7		1.7		V
		2.7–3.6		2.0		
V <sub>IL</sub>	LOW Level Input Voltage	2.3–2.7			0.7	V
		2.7–3.6			0.8	
V <sub>OH</sub>	HIGH Level Output Voltage	2.3–3.6	I <sub>OH</sub> = -100μA	V <sub>CC</sub> - 0.2		V
		2.3	I <sub>OH</sub> = -8mA	1.8		
		2.7	I <sub>OH</sub> = -12mA	2.2		
		3.0	I <sub>OH</sub> = -18mA	2.4		
			I <sub>OH</sub> = -24mA	2.2		
V <sub>OL</sub>	LOW Level Output Voltage	2.3–3.6	I <sub>OL</sub> = 100μA		0.2	V
		2.3	I <sub>OL</sub> = 8mA		0.6	
		2.7	I <sub>OL</sub> = 12mA		0.4	
		3.0	I <sub>OL</sub> = 16mA		0.4	
			I <sub>OL</sub> = 24mA		0.55	
I <sub>I</sub>	Input Leakage Current	2.3–3.6	0 ≤ V <sub>I</sub> ≤ 5.5V		±5.0	μA
I <sub>OZ</sub>	3-STATE Output Leakage	2.3–3.6	0 ≤ V <sub>O</sub> ≤ 5.5V, V <sub>I</sub> = V <sub>IH</sub> or V <sub>IL</sub>		±5.0	μA
I <sub>OFF</sub>	Power-Off Leakage Current	0	V <sub>I</sub> or V <sub>O</sub> = 5.5V		10	μA
I <sub>CC</sub>	Quiescent Supply Current	2.3–3.6	V <sub>I</sub> = V <sub>CC</sub> or GND		10	μA
			3.6V ≤ V <sub>I</sub> , V <sub>O</sub> ≤ 5.5V <sup>(5)</sup>		±10	
ΔI <sub>CC</sub>	Increase in I <sub>CC</sub> per Input	2.3–3.6	V <sub>IH</sub> = V <sub>CC</sub> - 0.6V		500	μA

## AC Electrical Characteristics

Symbol	Parameter	T <sub>A</sub> = -40°C to +85°C, R <sub>L</sub> = 500Ω						Units
		V <sub>CC</sub> = 3.3V ± 0.3V, C <sub>L</sub> = 50pF		V <sub>CC</sub> = 2.7V, C <sub>L</sub> = 50pF		V <sub>CC</sub> = 2.5V ± 0.2V, C <sub>L</sub> = 30pF		
		Min.	Max.	Min.	Max.	Min.	Max.	
f <sub>MAX</sub>	Maximum Clock Frequency	150		150		150		MHz
t <sub>PHL</sub> , t <sub>PLH</sub>	Propagation Delay CP to O <sub>n</sub>	1.5	8.5	1.5	9.5	1.5	10.5	ns
t <sub>PZL</sub> , t <sub>PZH</sub>	Output Enable Time	1.5	8.5	1.5	9.5	1.5	10.5	ns
t <sub>PLZ</sub> , t <sub>PHZ</sub>	Output Disable Time	1.5	7.5	1.5	8.5	1.5	9.0	ns
t <sub>S</sub>	Setup Time	2.5		2.5		4.0		ns
t <sub>H</sub>	Hold Time	1.5		1.5		2.0		ns
t <sub>W</sub>	Pulse Width	3.3		3.3		4.0		ns
t <sub>OSHL</sub> , t <sub>OSLH</sub>	Output to Output Skew <sup>(6)</sup>		1.0					ns

## Notes:

- Outputs disabled or 3-STATE only.
- Skew is defined as the absolute value of the difference between the actual propagation delay for any two separate outputs of the same device. The specification applies to any outputs switching in the same direction, either HIGH-to-LOW (t<sub>OSHL</sub>) or LOW-to-HIGH (t<sub>OSLH</sub>).

**Dynamic Switching Characteristics**

Symbol	Parameter	V <sub>CC</sub> (V)	Conditions	T <sub>A</sub> = 25°C	
				Typical	Units
V <sub>OLP</sub>	Quiet Output Dynamic Peak V <sub>OL</sub>	3.3	C <sub>L</sub> = 50pF, V <sub>IH</sub> = 3.3V, V <sub>IL</sub> = 0V	0.8	V
		2.5	C <sub>L</sub> = 30pF, V <sub>IH</sub> = 2.5V, V <sub>IL</sub> = 0V	0.6	
V <sub>OLV</sub>	Quiet Output Dynamic Valley V <sub>OL</sub>	3.3	C <sub>L</sub> = 50pF, V <sub>IH</sub> = 3.3V, V <sub>IL</sub> = 0V	-0.8	V
		2.5	C <sub>L</sub> = 30pF, V <sub>IH</sub> = 2.5V, V <sub>IL</sub> = 0V	-0.6	

**Capacitance**

Symbol	Parameter	Conditions	Typical	Units
C <sub>IN</sub>	Input Capacitance	V <sub>CC</sub> = Open, V <sub>I</sub> = 0V or V <sub>CC</sub>	7	pF
C <sub>OUT</sub>	Output Capacitance	V <sub>CC</sub> = 3.3V, V <sub>I</sub> = 0V or V <sub>CC</sub>	8	pF
C <sub>PD</sub>	Power Dissipation Capacitance	V <sub>CC</sub> = 3.3V, V <sub>I</sub> = 0V or V <sub>CC</sub> , f = 10 MHz	25	pF

## AC Loading and Waveforms (Generic for LCX Family)

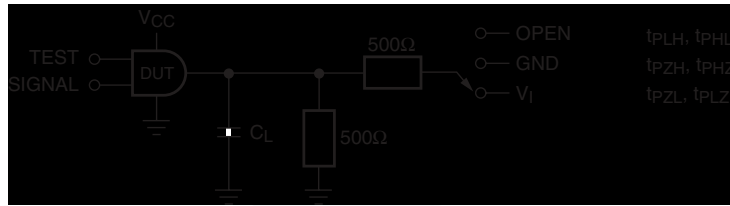
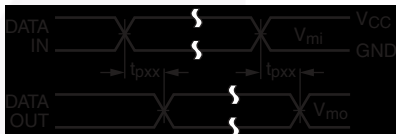
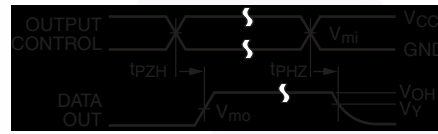

Figure 1. AC Test Circuit ( $C_L$  includes probe and jig capacitance)

Test	Switch
$t_{PLH}$ , $t_{PHL}$	Open
$t_{PZL}$ , $t_{PLZ}$	6V at $V_{CC} = 3.3 \pm 0.3V$ $V_{CC} \times 2$ at $V_{CC} = 2.5 \pm 0.2V$
$t_{PZH}$ , $t_{PHZ}$	GND



Waveform for Inverting and Non-Inverting Functions



3-STATE Output High Enable and Disable Times for Logic

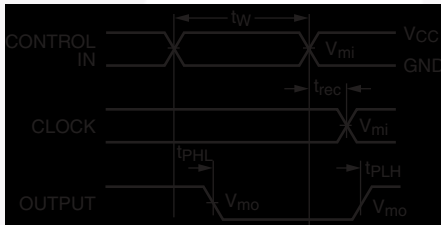

Propagation Delay, Pulse Width and  $t_{rec}$  Waveforms

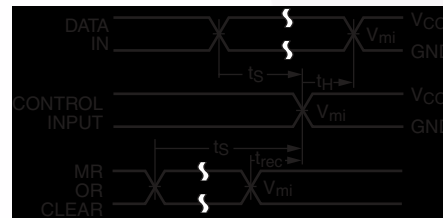

Setup Time, Hold Time and Recovery Time for Logic

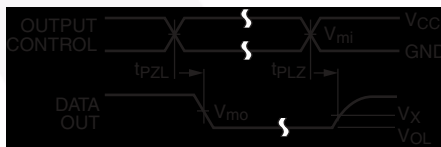

3-STATE Output Low Enable and Disable Times for Logic

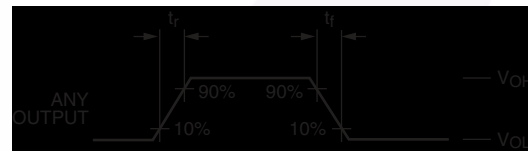

$t_{rise}$  and  $t_{fall}$

Figure 2. Waveforms (Input Characteristics;  $f = 1MHz$ ,  $t_r = t_f = 3ns$ )

Symbol	$V_{CC}$		
	$3.3V \pm 0.3V$	$2.7V$	$2.5V \pm 0.2V$
$V_{mi}$	1.5V	1.5V	$V_{CC} / 2$
$V_{mo}$	1.5V	1.5V	$V_{CC} / 2$
$V_x$	$V_{OL} + 0.3V$	$V_{OL} + 0.3V$	$V_{OL} + 0.15V$
$V_y$	$V_{OH} - 0.3V$	$V_{OH} - 0.3V$	$V_{OH} - 0.15V$

**Schematic Diagram** (Generic for LCX Family)





## Tape and Reel Specification

### Tape Format for DQFN

Package Designator	Tape Section	Number Cavities	Cavity Status	Cover Tape Status
BQX	Leader (Start End)	125 (typ)	Empty	Sealed
	Carrier	3000	Filled	Sealed
	Trailer (Hub End)	75 (typ)	Empty	Sealed

### Tape Dimensions inches (millimeters)

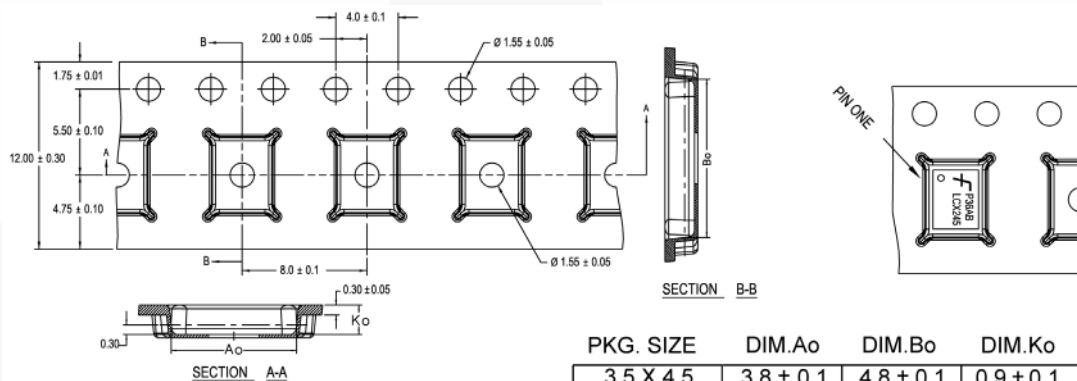

PKG. SIZE	DIM.Ao	DIM.Bo	DIM.Ko
3.5 X 4.5	$3.8 \pm 0.1$	$4.8 \pm 0.1$	$0.9 \pm 0.1$
3.0 X 3.0	$3.3 \pm 0.1$	$3.3 \pm 0.1$	$0.9 \pm 0.1$
2.5 X 4.5	$2.8 \pm 0.1$	$4.8 \pm 0.1$	$0.9 \pm 0.1$
2.5 X 3.5	$2.8 \pm 0.1$	$3.8 \pm 0.1$	$0.9 \pm 0.1$
2.5 X 3.0	$2.8 \pm 0.1$	$3.3 \pm 0.1$	$0.9 \pm 0.1$
2.5 X 2.5	$2.8 \pm 0.1$	$2.8 \pm 0.1$	$0.9 \pm 0.1$

DIMENSIONS ARE IN MILLIMETERS

NOTES: unless otherwise specified

1. Cumulative pitch for feeding holes and cavities (chip pockets) not to exceed 0.008[0.20] over 10 pitch span.
2. Smallest allowable bending radius.
3. Thru hole inside cavity is centered within cavity.
4. Tolerance is  $\pm 0.002[0.05]$  for these dimensions on all 12mm tapes.
5. Ao and Bo measured on a plane 0.120[0.30] above the bottom of the pocket.
6. Ko measured from a plane on the inside bottom of the pocket to the top surface of the carrier.
7. Pocket position relative to sprocket hole measured as true position of pocket. Not pocket hole.
8. Controlling dimension is millimeter. Dimension in inches rounded.

### Reel Dimensions inches (millimeters)

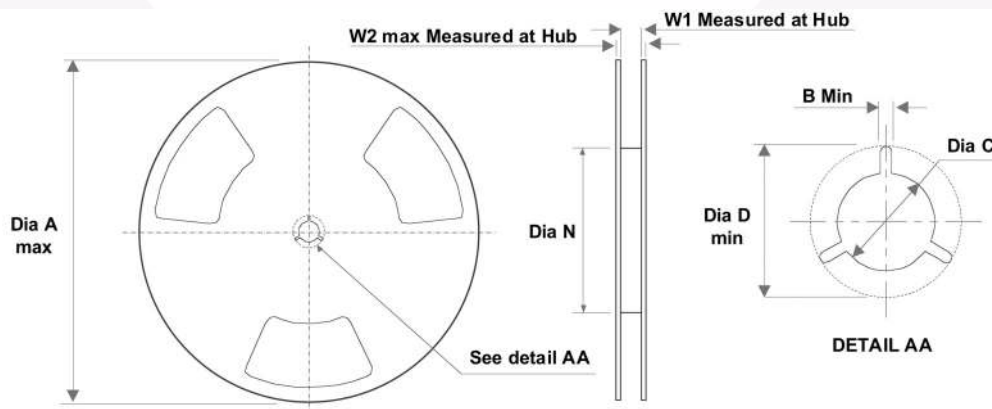

Tape Size	A	B	C	D	N	W1	W2
12mm	13.0 (330.0)	0.059 (1.50)	0.512 (13.00)	0.795 (20.20)	2.165 (55.00)	0.488 (12.4)	0.724 (18.4)

## Physical Dimensions

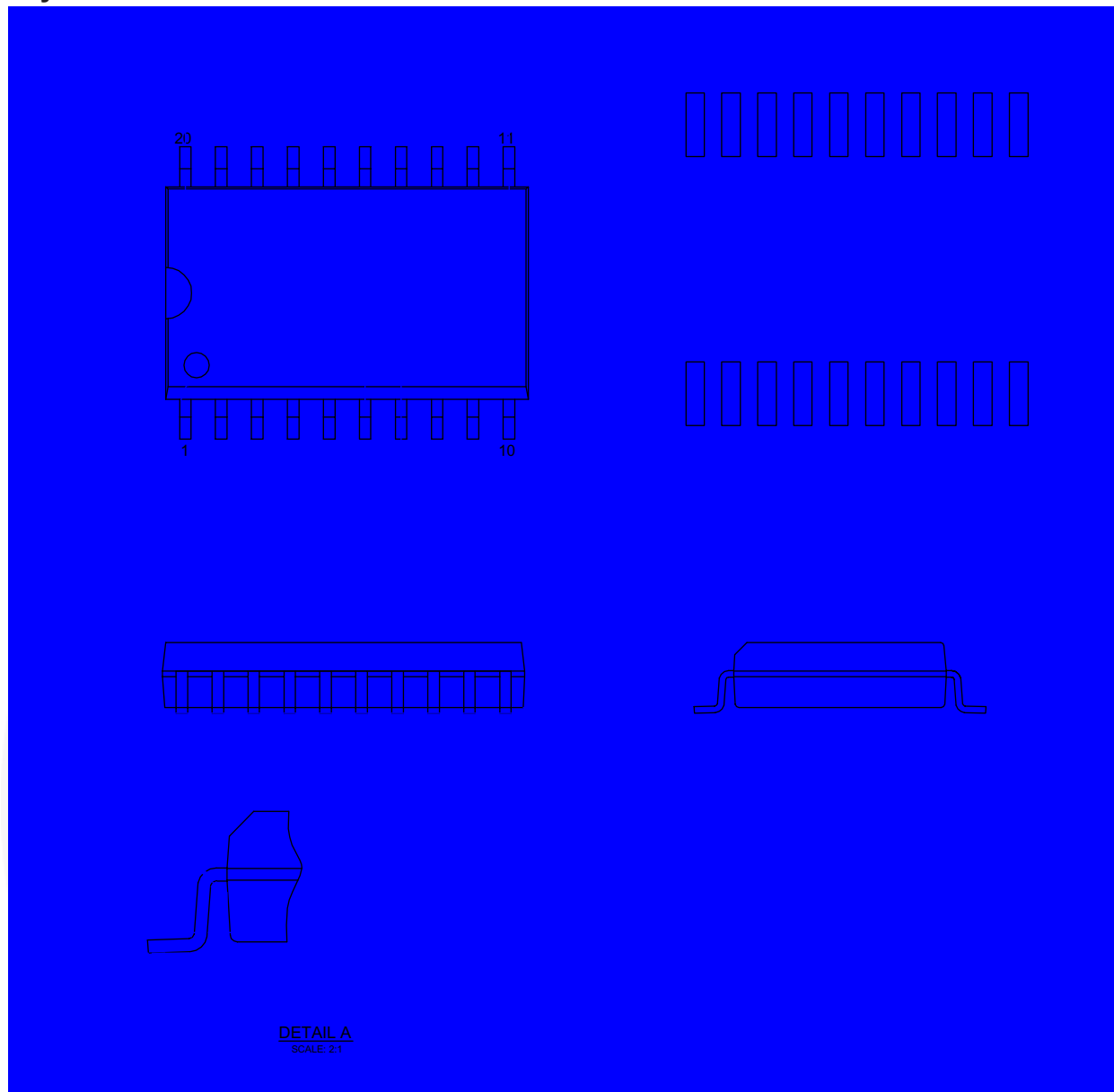

**Figure 3. 20-Lead Small Outline Integrated Circuit (SOIC), JEDEC MS-013, 0.300" Wide**

Package drawings are provided as a service to customers considering Fairchild components. Drawings may change in any manner without notice. Please note the revision and/or date on the drawing and contact a Fairchild Semiconductor representative to verify or obtain the most recent revision. Package specifications do not expand the terms of Fairchild's worldwide terms and conditions, specifically the warranty therein, which covers Fairchild products.

Always visit Fairchild Semiconductor's online packaging area for the most recent package drawings:

<http://www.fairchildsemi.com/packaging/>

Physical Dimensions (Continued)

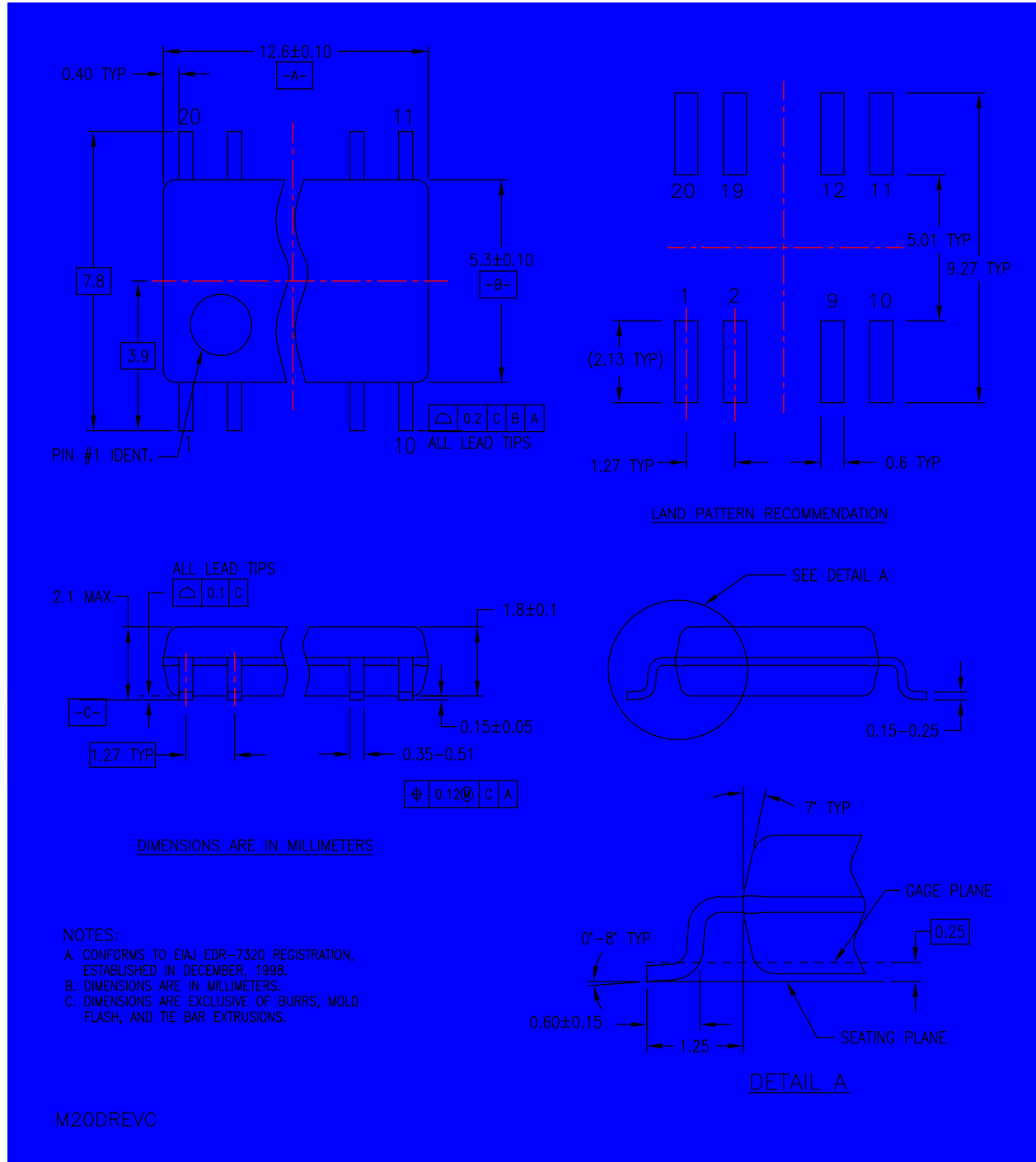

Figure 4. 20-Lead Small Outline Package (SOP), EIAJ TYPE II, 5.3mm Wide

Package drawings are provided as a service to customers considering Fairchild components. Drawings may change in any manner without notice. Please note the revision and/or date on the drawing and contact a Fairchild Semiconductor representative to verify or obtain the most recent revision. Package specifications do not expand the terms of Fairchild's worldwide terms and conditions, specifically the warranty therein, which covers Fairchild products.

Always visit Fairchild Semiconductor's online packaging area for the most recent package drawings:

<http://www.fairchildsemi.com/packaging/>

### Physical Dimensions (Continued)

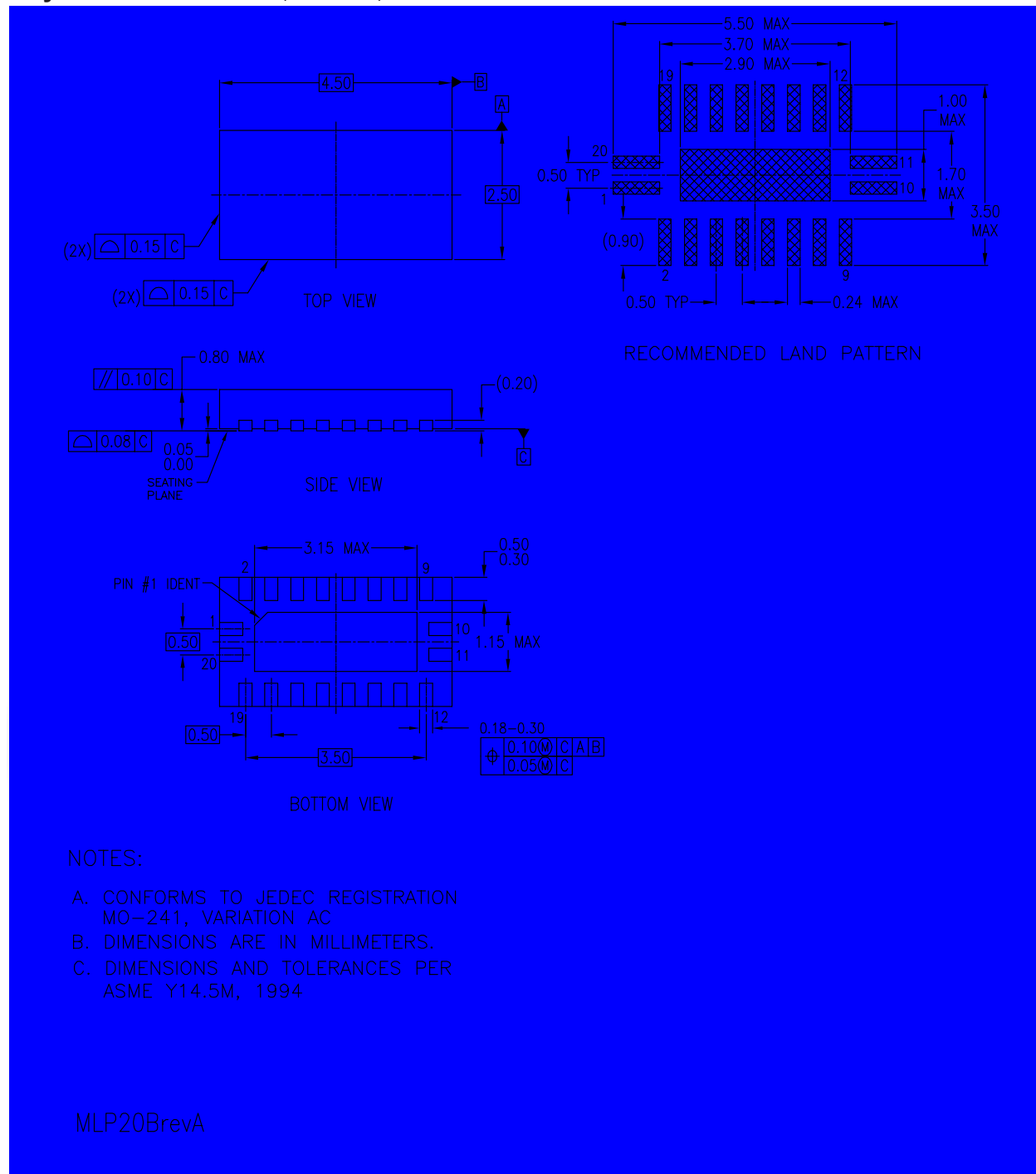

**Figure 5. 20-Terminal Depopulated Quad Very-Thin Flat Pack No Leads (DQFN), JEDEC MO-241, 2.5 x 4.5mm**

Package drawings are provided as a service to customers considering Fairchild components. Drawings may change in any manner without notice. Please note the revision and/or date on the drawing and contact a Fairchild Semiconductor representative to verify or obtain the most recent revision. Package specifications do not expand the terms of Fairchild's worldwide terms and conditions, specifically the warranty therein, which covers Fairchild products.

Always visit Fairchild Semiconductor's online packaging area for the most recent package drawings:

<http://www.fairchildsemi.com/packaging/>

Physical Dimensions (Continued)

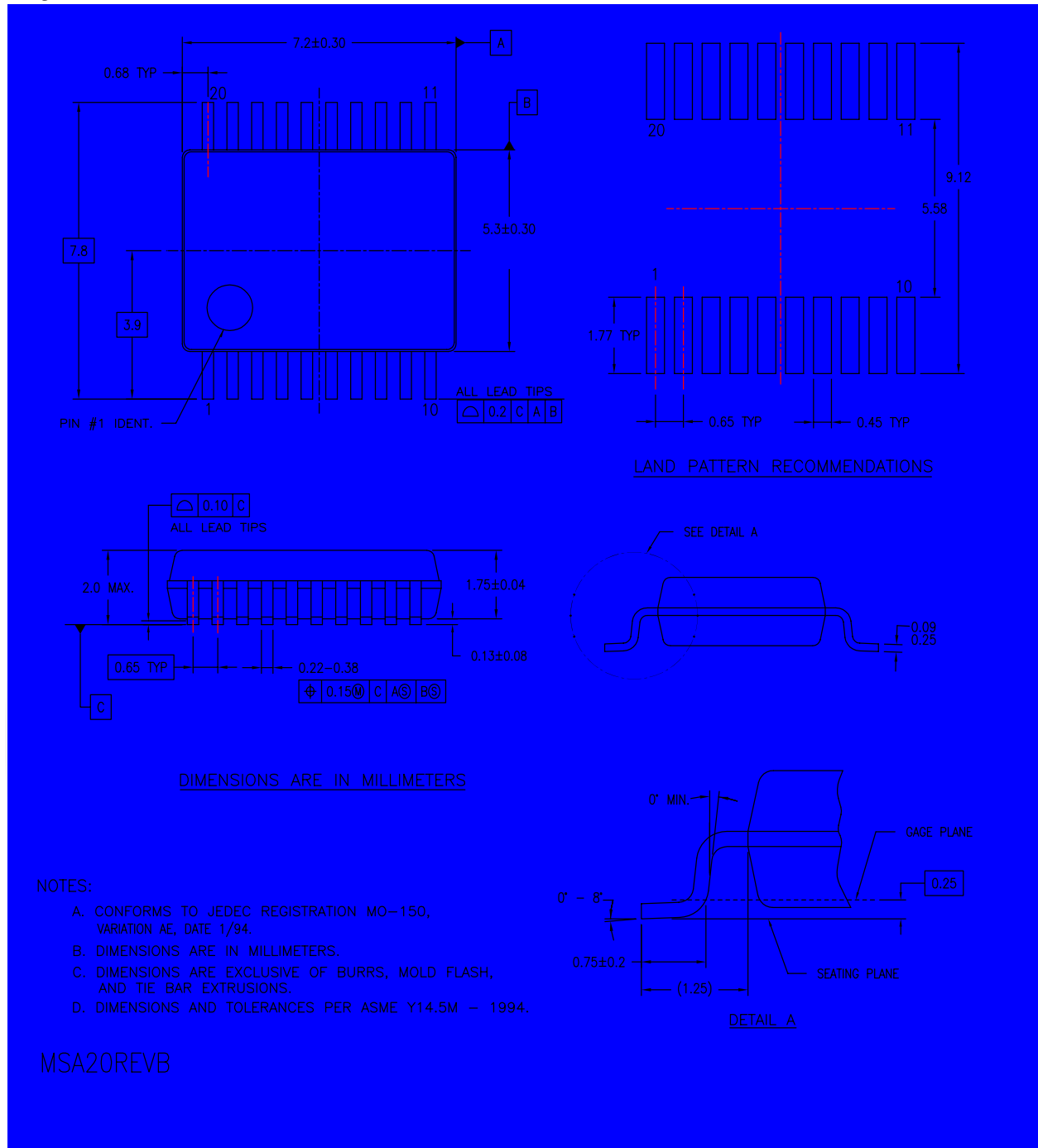

Figure 6. 20-Lead Shrink Small Outline Package (SSOP), JEDEC MO-150, 5.3mm Wide

Package drawings are provided as a service to customers considering Fairchild components. Drawings may change in any manner without notice. Please note the revision and/or date on the drawing and contact a Fairchild Semiconductor representative to verify or obtain the most recent revision. Package specifications do not expand the terms of Fairchild's worldwide terms and conditions, specifically the warranty therein, which covers Fairchild products.

Always visit Fairchild Semiconductor's online packaging area for the most recent package drawings:

<http://www.fairchildsemi.com/packaging/>

Physical Dimensions (Continued)

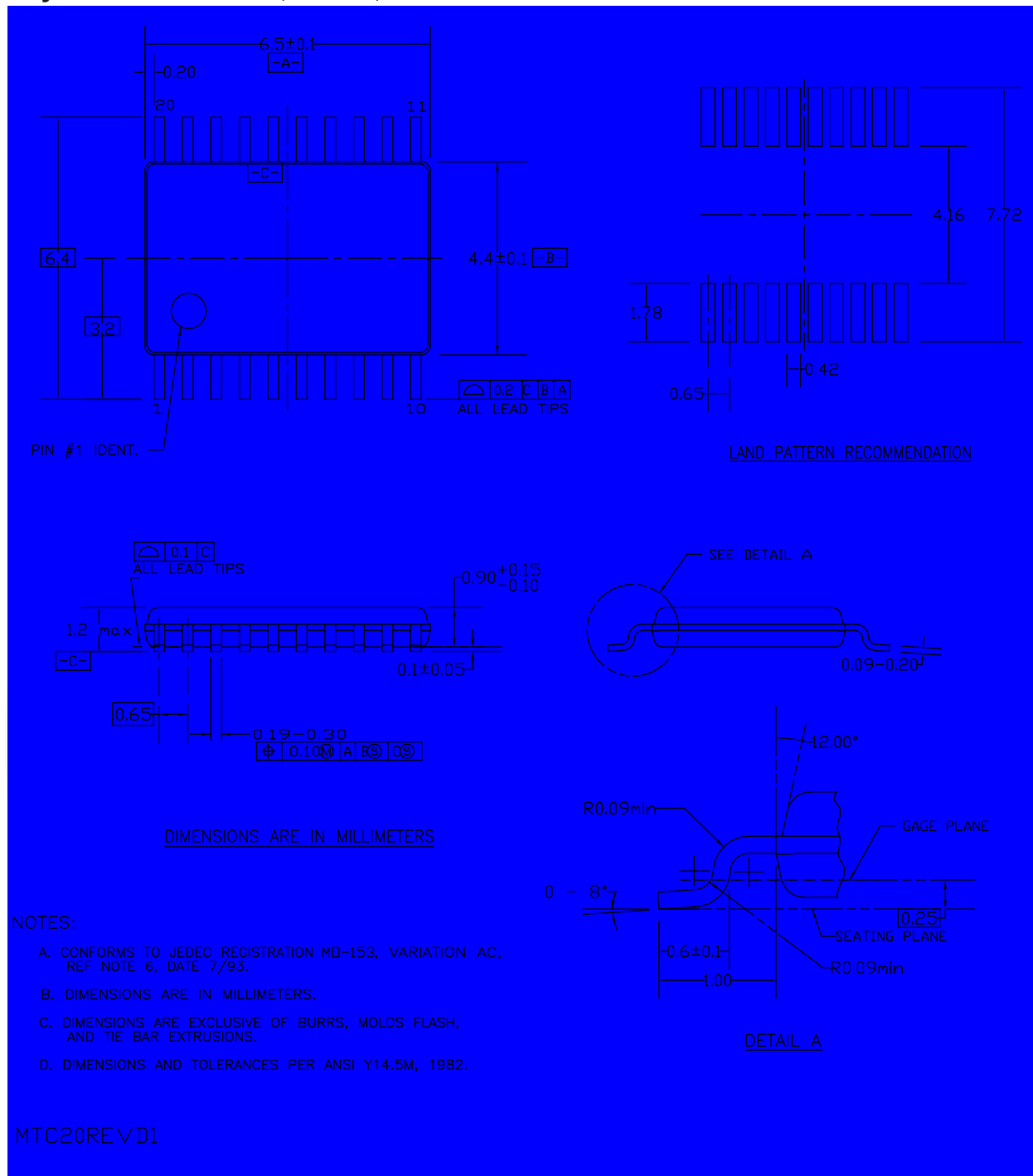

Figure 7. 20-Lead Thin Shrink Small Outline Package (TSSOP), JEDEC MO-153, 4.4mm Wide

Package drawings are provided as a service to customers considering Fairchild components. Drawings may change in any manner without notice. Please note the revision and/or date on the drawing and contact a Fairchild Semiconductor representative to verify or obtain the most recent revision. Package specifications do not expand the terms of Fairchild's worldwide terms and conditions, specifically the warranty therein, which covers Fairchild products.





Always visit Fairchild Semiconductor's online packaging area for the most recent package drawings:

<http://www.fairchildsemi.com/packaging/>



**TRADEMARKS**

The following includes registered and unregistered trademarks and service marks, owned by Fairchild Semiconductor and/or its global subsidiaries, and is not intended to be an exhaustive list of all such trademarks.

- |   |  |   |   |
|---|--|---|---|
| AccuPower™  | F-PFS™   |  | Sync-Lock™  |
| AX-CAP®*  | FRFET®   | PowerXS™  |  |
| BitSiC™   | Global Power Resource™                         | PowerTrench®  | TinyBoost®  |
| Build it Now™   | GreenBridge™                                   | PowerXS™  | TinyBuck®   |
| CorePLUS™   | Green FPS™                                     | Programmable Active Droop™  | TinyCalc™   |
| CorePOWER™  | Green FPS™ e-Series™                           | QFET®   | TinyLogic®  |
| CROSSVOLT™  | Gmax™  | QS™   | TINYOPTO™   |
| CTL™  | GTO™   | Quiet Series™   | TinyPower™  |
| Current Transfer Logic™   | IntelliMAX™                                    | RapidConfigure™   | TinyPWM™  |
| DEUXPEED®   | ISOPLANAR™                                     |  | TinyWire™   |
| Dual Cool™  | Making Small Speakers Sound Louder and Better™ | Saving our world, 1mW/W/kW at a time™   | TranSiC™  |
| EcoSPARK®   | MegaBuck™                                      | SignalWise™   | TriFault Detect™  |
| EfficientMax™   | MICROCOUPLER™                                  | SmartMax™   | TRUECURRENT®*   |
| ESBC™   | MicroFET™                                      | SMART START™  | μSerDes™  |
|  | MicroPak™                                      | Solutions for Your Success™   |  |
| Fairchild®  | MicroPak2™                                     | SPM®  | UHC®  |
| Fairchild Semiconductor®  | MillerDrive™                                   | STEALTH™  | Ultra FRFET™  |
| FACT Quiet Series™  | MotionMax™                                     | SuperFET®   | UniFET™   |
| FACT®   | mWSaver®                                       | SuperSOT™-3   | VcX™  |
| FAST®   | OptoHiT™                                       | SuperSOT™-6   | VisualMax™  |
| FastvCore™  | OPTOLOGIC®                                     | SuperSOT™-8   | VoltagePlus™  |
| FETBench™   | OPTOPLANAR®                                    | SupreMOS®   | XS™   |
| FPS™  |  | SyncFET™  |   |

\* Trademarks of System General Corporation, used under license by Fairchild Semiconductor.

**DISCLAIMER**

FAIRCHILD SEMICONDUCTOR RESERVES THE RIGHT TO MAKE CHANGES WITHOUT FURTHER NOTICE TO ANY PRODUCTS HEREIN TO IMPROVE RELIABILITY, FUNCTION, OR DESIGN. FAIRCHILD DOES NOT ASSUME ANY LIABILITY ARISING OUT OF THE APPLICATION OR USE OF ANY PRODUCT OR CIRCUIT DESCRIBED HEREIN; NEITHER DOES IT CONVEY ANY LICENSE UNDER ITS PATENT RIGHTS, NOR THE RIGHTS OF OTHERS. THESE SPECIFICATIONS DO NOT EXPAND THE TERMS OF FAIRCHILD'S WORLDWIDE TERMS AND CONDITIONS, SPECIFICALLY THE WARRANTY THEREIN, WHICH COVERS THESE PRODUCTS.

**LIFE SUPPORT POLICY**

FAIRCHILD'S PRODUCTS ARE NOT AUTHORIZED FOR USE AS CRITICAL COMPONENTS IN LIFE SUPPORT DEVICES OR SYSTEMS WITHOUT THE EXPRESS WRITTEN APPROVAL OF FAIRCHILD SEMICONDUCTOR CORPORATION.

As used herein:

1. Life support devices or systems are devices or systems which, (a) are intended for surgical implant into the body or (b) support or sustain life, and (c) whose failure to perform when properly used in accordance with instructions for use provided in the labeling, can be reasonably expected to result in a significant injury of the user.
2. A critical component in any component of a life support, device, or system whose failure to perform can be reasonably expected to cause the failure of the life support device or system, or to affect its safety or effectiveness.

**ANTI-COUNTERFEITING POLICY**

Fairchild Semiconductor Corporation's Anti-Counterfeiting Policy. Fairchild's Anti-Counterfeiting Policy is also stated on our external website, [www.fairchildsemi.com](http://www.fairchildsemi.com), under Sales Support.

Counterfeiting of semiconductor parts is a growing problem in the industry. All manufacturers of semiconductor products are experiencing counterfeiting of their parts. Customers who inadvertently purchase counterfeit parts experience many problems such as loss of brand reputation, substandard performance, failed applications, and increased cost of production and manufacturing delays. Fairchild is taking strong measures to protect ourselves and our customers from the proliferation of counterfeit parts. Fairchild strongly encourages customers to purchase Fairchild parts either directly from Fairchild or from Authorized Fairchild Distributors who are listed by country on our web page cited above. Products customers buy either from Fairchild directly or from Authorized Fairchild Distributors are genuine parts, have full traceability, meet Fairchild's quality standards for handling and storage and provide access to Fairchild's full range of up-to-date technical and product information. Fairchild and our Authorized Distributors will stand behind all warranties and will appropriately address any warranty issues that may arise. Fairchild will not provide any warranty coverage or other assistance for parts bought from Unauthorized Sources. Fairchild is committed to combat this global problem and encourage our customers to do their part in stopping this practice by buying direct or from authorized distributors.

**PRODUCT STATUS DEFINITIONS**

**Definition of Terms**

Datasheet Identification	Product Status	Definition
Advance Information	Formative / In Design	Datasheet contains the design specifications for product development. Specifications may change in any manner without notice.
Preliminary	First Production	Datasheet contains preliminary data; supplementary data will be published at a later date. Fairchild Semiconductor reserves the right to make changes at any time without notice to improve design.
No Identification Needed	Full Production	Datasheet contains final specifications. Fairchild Semiconductor reserves the right to make changes at any time without notice to improve the design.
Obsolete	Not In Production	Datasheet contains specifications on a product that is discontinued by Fairchild Semiconductor. The datasheet is for reference information only.

Rev. I66