

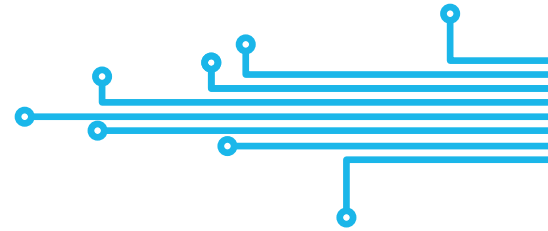

# SGX

## SENSORTECH

An Amphenol Company



PS1&PS4-CO-1000-MOD

# Carbon Monoxide Module

# Datasheet

Small size | Low cost | Long life | Fast response | High accuracy | Low power consumption



*Quality, Safety, Responsibility*

## Product note

The PS1&PS4-CO-1000-MOD series carbon monoxide module is the perfect combination of our sensor with an advanced printed circuit board. SGX Sensortech gas sensors are using a revolutionary 'Solid Polymer Electrolyte' technology that is based on the principle of catalytic reaction. The target gas to be measured generates a very small current, proportional to the gas concentration. Our technology offers a stable, high quality and cost-effective manufacturing process.

The module is equipped with a standard UART digital output, allowing operation by anyone without knowledge or understanding of the sensor application and the tedious work of calibration.

## Features

- Sleeping function good for low power request IOT applications
- Combined with intelligent algorithms, it has stronger adaptability to the environment, more accurate detection, and stable zero point
- Good anti-toxicity, no consumption of chemical materials, more than 5 years Life time
- New micro circuit design, strong anti-electromagnetic interference ability
- Fast response, fast return to zero, plug and play
- Independent temperature and humidity digital sensor output
- The smallest size and lowest power consumption in the electrochemical field
- RoHS Eco-friendly design

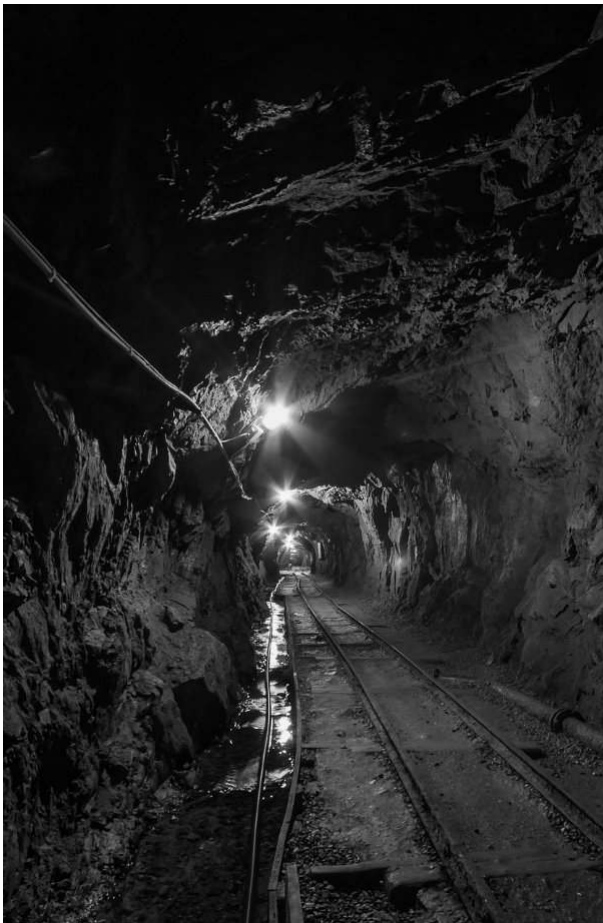
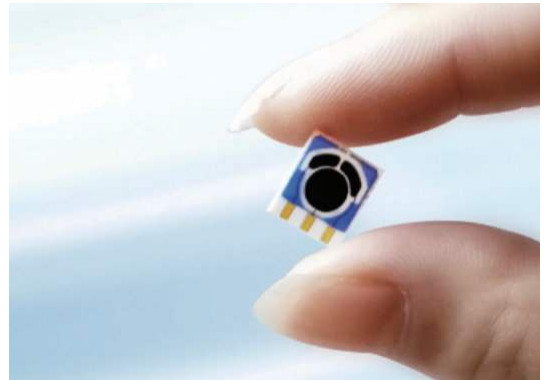

## Application

- Early warning and monitoring of domestic environmental fires
- Early warning of automobile lithium battery failure (fire)
- Security / Fire and Fire Early Warning Monitoring
- Industrial and agricultural fuel burning
- Natural gas production preparation
- Metallurgical electronics industry
- Industrial oil depot
- Mine



## Cross Sensitivity

Gas	Formula	Test Concentration	Sensor Reading
Acetylene	C <sub>2</sub> H <sub>2</sub>	1%vol	0ppm
Ammonia	NH <sub>3</sub>	50ppm	0ppm
Benzene	C <sub>6</sub> H <sub>6</sub>	986.5ppm	0ppm
Chlorine	CL <sub>2</sub>	1ppm	0ppm
Ethanol	C <sub>2</sub> H <sub>6</sub> O	104.2ppm	0ppm
Ethylene oxide	C <sub>2</sub> H <sub>4</sub> O	14.4ppm	0ppm
Formaldehyde	HCHO	1ppm	0ppm
Hydrogen	H <sub>2</sub>	1000ppm	500ppm
Hydrogen cyanide	HCN	50ppm	0ppm
Hydrogen sulfide	H <sub>2</sub> S	50ppm	0ppm
Isobutene	C <sub>4</sub> H <sub>8</sub>	300ppm	0ppm
Methane	CH <sub>4</sub>	3%vol	0ppm
Methylene chloride	CH <sub>2</sub> CL <sub>2</sub>	30ppm	0ppm
Nitrogen Dioxide	NO <sub>2</sub>	10ppm	0ppm
Ozone	O <sub>3</sub>	50ppm	0ppm
Sulphur Dioxide	SO <sub>2</sub>	10ppm	0ppm

**Note:** 1) The above interference factors may be different due to different sensors and service life, please refer to the actual test results.

2) This table is not complete for all gases, and the sensor may be sensitive to other gases.

## Order Informations

	Part Number	Range	Resolution
Carbon Monoxide Gas Module	PS1-CO-1000-MOD	0-1000ppm	0.1ppm
Carbon Monoxide Gas Module 4Pin Cable	PS4-CO-1000-MOD Module 4 PIN cable	0-1000ppm	0.1ppm

## Specification

Principle	Solid Polymer Electrochemical Sensing Technology
Detection of gas	Carbon monoxide gas
Detection Range	0-1000ppm; Resolution: 0.1ppm
Lowest Detection Limit	1ppm
Full-scale accuracy error	± 5% F.S
Repeatability	<2%
Warm-up time	The first power-on under storage in clean air <120 seconds
	The first power-up under storage in non-clean air <240 seconds (except in the presence of high concentrations of polluted gas)
Response time	T50: <10 seconds; T90: <30 seconds
Return zero time	<120 seconds (Pass 99.999% high purity nitrogen)
Calibration Gas	Carbon monoxide standard gas 500ppm
	Note: The standard gas uses air as the background gas
Sensor expected life time	>5 years
	Note: Temperature (0-25) °C, Humidity (30-70)% RH, the measured gas concentration is within the range, and there is no gas environment that affects the warm-up time mentioned above
Output	The standard output is: 3.3V UART digital signal (see below for communication protocol) ; Optional custom Modbus protocol
	Interface definition: VCC- Red, GND- Black, RX- Yellow, TX- Green; Baud rate: 9600 Data bits: 8 bits Stop bits: 1 bit
Get data command	The communication is divided into active uploading and Q & A. The default is Q & A mode after power-on. You can use instructions to switch between the two modes.
	Return to Q & A mode after power off or switch power mode
	See next page for details
Working Voltage	3.3-5.5V DC
Working Current	< 5mA
Power Consumption	25mW @ 5V DC
Working temperature	(-40 - 55) °C
Optimal working temperature	(20 - 35) °C
Working humidity	(15-95 ) %RH. (Non-condensing)
Optimum working humidity	50% RH.
Working pressure	Atm ± 10%
Circuit board size	40X30X5.6 (mm)
Module size	With PS1 sensor: 40X30X12 (mm); With PS4 sensor: 40X30X22.45 (mm)
Weight	PS1-CO-1000-MOD < 15g; PS4-CO-1000-MOD < 25g
Temperature and humidity sensor Data	Temperature Range: (-40~85) °C Relative error: ± 0.2 °C
	Humidity measurement range: (10 ~ 95)% RH non-condensing Relative error: ± 2%
Warranty	12 months from the date of shipment

## Structure Diagram (unit in mm)

### PS1-CO-1000-MOD Dimension diagram

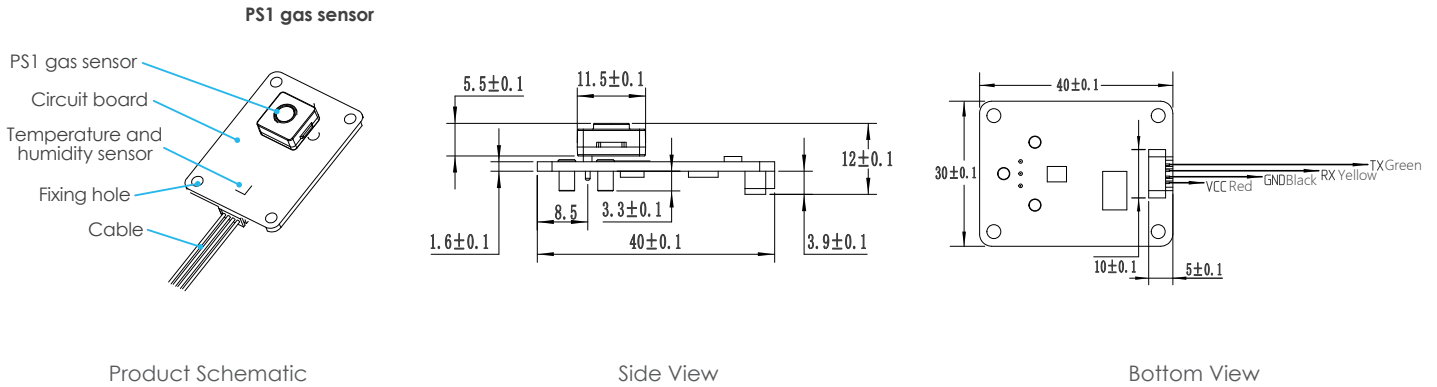

### PS4-CO-1000-MOD Dimension diagram

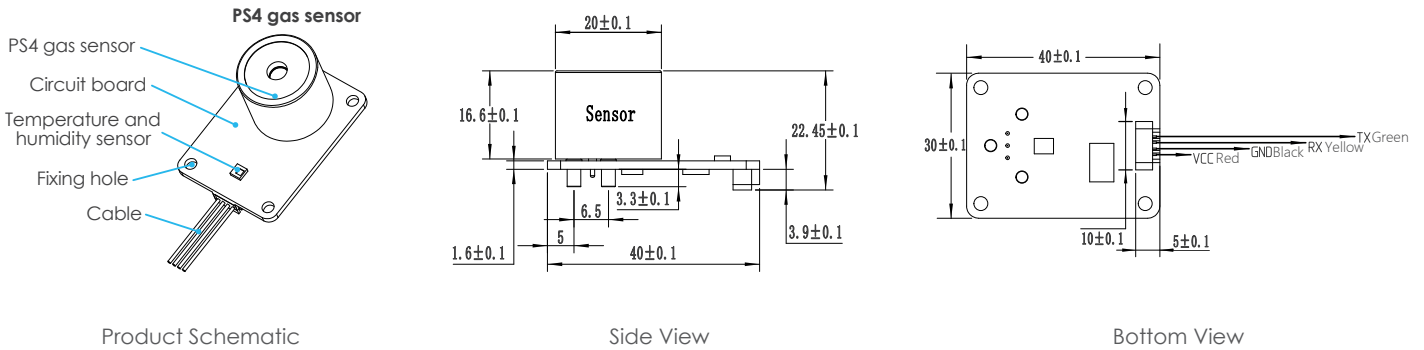

### 4Pin cable size diagram

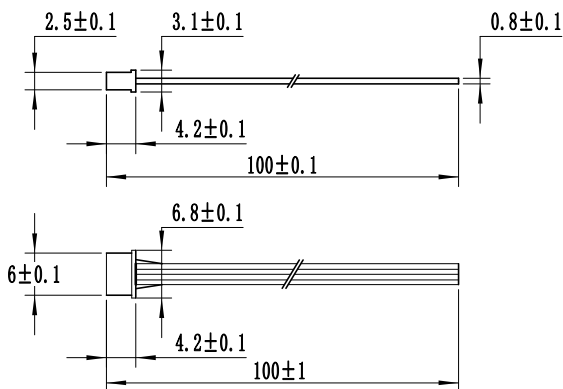

## Linearity

Temperature environment: 26 °C; Humidity environment: 55%; Air chamber space: 0.03m³; Ventilation flow of air distribution system: 4000sccm

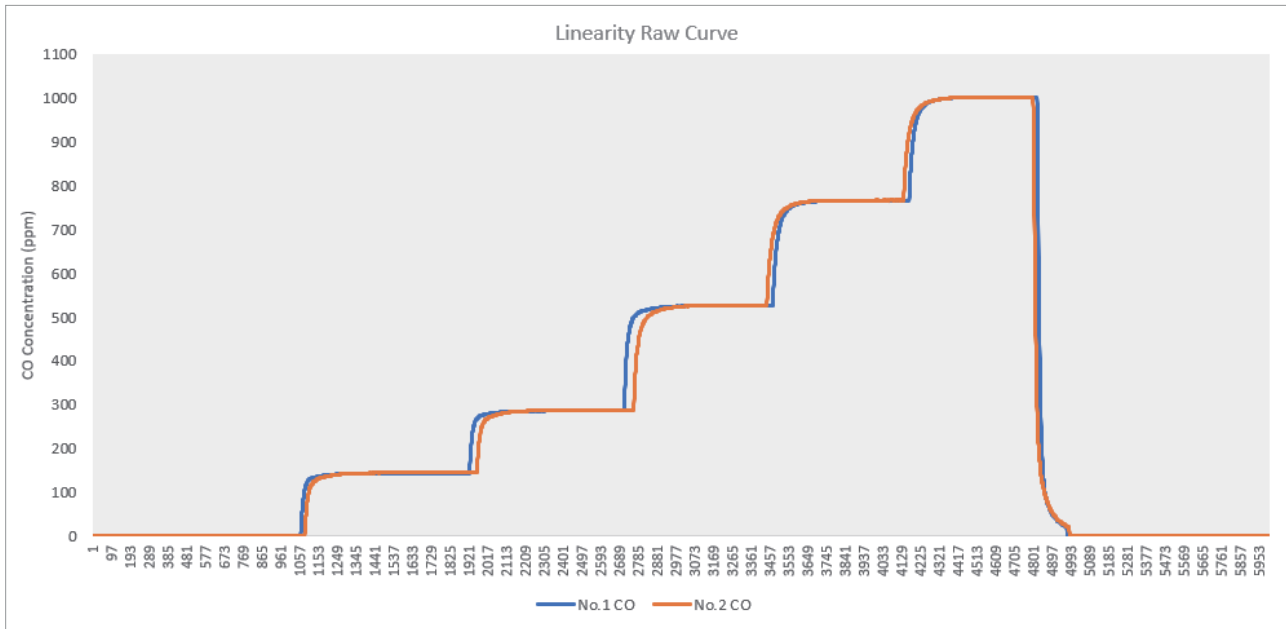

## Repeatability

Temperature environment: 26 °C; Humidity environment: 55%; Air chamber space: 0.03m³; Ventilation flow of air distribution system: 3000sccm

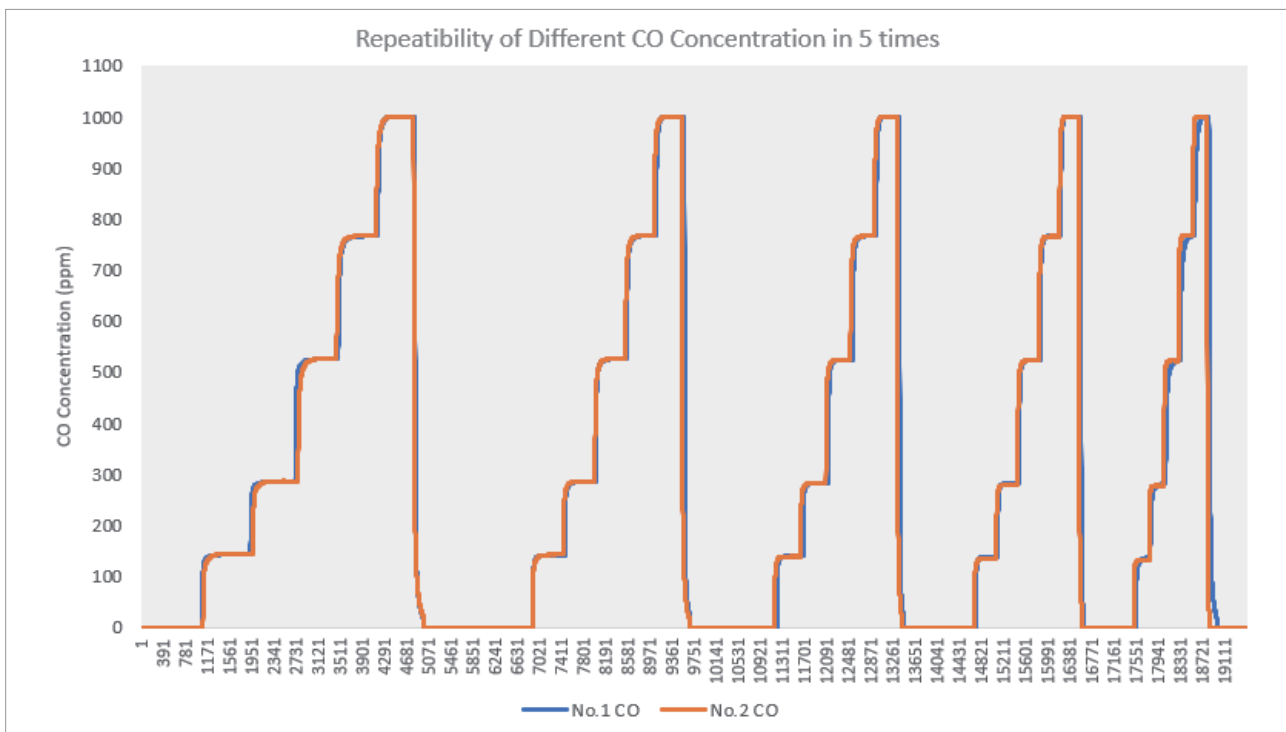

## Temperature

Temperature environment: -15, -5, 10, 30, 50 °C; air chamber space: 0.03m<sup>3</sup>; ventilation flow of gas distribution system: 3000scm, Carbon Monoxide sen-sor is negative reaction

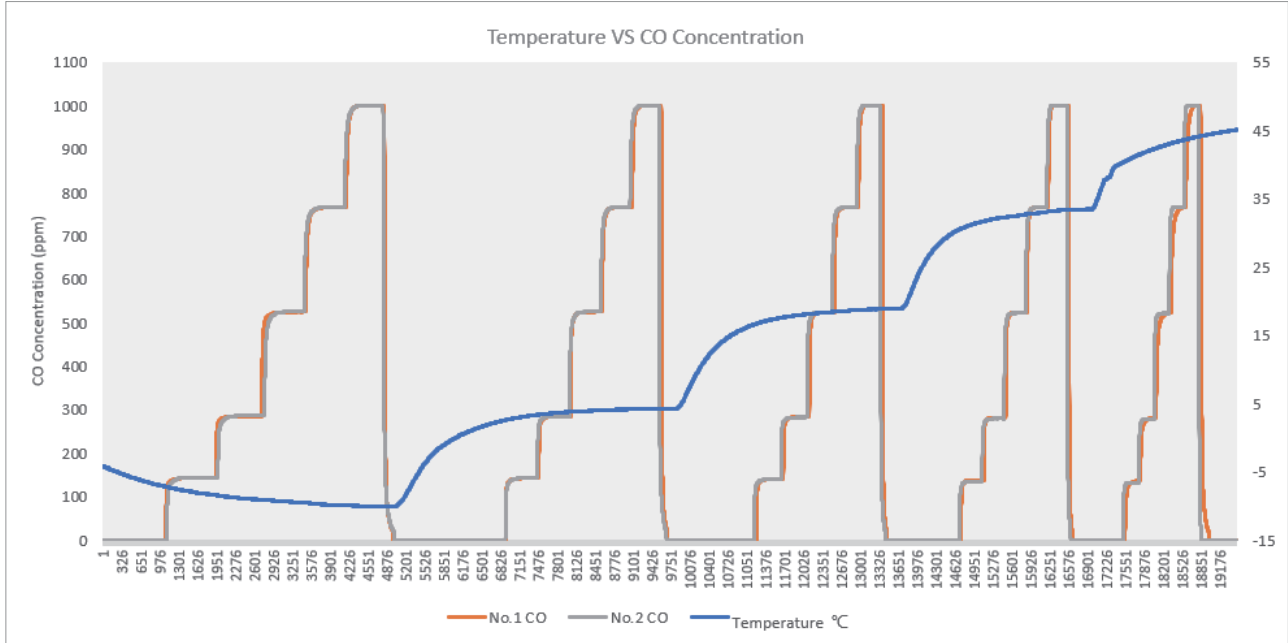

## User Guide

Thank you for choosing SGX Sensortech module. Before using it, please read this document in detail in order to use our products correctly and effectively.

### Storage

1. The best storage environment is: temperature (0-20) °C, relative humidity 50% RH (non-condensing);
2. The storage environment should keep the air clean, no pollution gas, no acetone, no high concentration organic gas, no dust, no smoke;
3. Avoid storage with alcohol (ethanol), perfume, sodium silicate and polyurethane liquids or solids;
4. Avoid high temperature and low humidity storage.

### Packing and shipping

1. Avoid prolonged direct sunlight during transportation, prevent rainwater penetration;
2. Transport packaging should be protected with shock-proof bubble film or non-odor environmentally friendly sponge;
3. During long-distance transportation, the temperature inside the sensor package should be kept within 40 °C as much as possible, and the maximum temperature should not exceed 55 °C (can not be stored or used at this temperature for a long time), and the humidity should not be less than 15% RH;

### Steps for usage

#### 1. Warm-up

- The Carbon Monoxide Gas Module is designed with plug-and-play function, but because the Carbon Monoxide sensor has its own bias voltage, by calibrated finished product, it still takes about 20 minutes to warm up prior first time use. When the output signal is constant, the warm-up is complete.  
  
(Note: under different storage and measurement environments, the first electrode stabilization time is different)
- When warming up, it is recommended to first warm the machine in clean air for about 20 minutes, observe whether the output of the carbon monoxide module is 0ppm (due to storage and environmental differences, the indicated value <3ppm can be confirmed as normal), confirm carbon monoxide after the module is normal, put it into the environment under test and let the sensor adapt to its environment. At this time, valid data can be obtained.

#### 2. Connection

- Please refer to the 4Pin cable in the "Structure Diagram" above. For the power supply, see the voltage and current ranges marked in the performance indicators. Note: incorrect wiring will cause the module to malfunction or damage the module.

#### 3. Diffusion use

- When using in a closed environment, it is necessary to ensure a constant pressure and the working pressure range is within  $\pm 10\%$  of atmospheric pressure. To ensure accurate measurement data, when using under different pressure environments, re-sensitivity calibration should be performed according to the pressure of the use environment.
- Usually the change of pressure will cause the output signal to change. If the pressure increase, the signal will increase, the pressure change suddenly, and the sensor signal will have a sudden change in peak value.

#### 4. Pump suction use

- When using the sensor in the pumping detection mode, the gas flow rate must be controlled within 500ml per minute, and the flow rate must be stable. The change of flow will cause the signal to fluctuate. When the flow is large, it will bring the change of pressure, which will cause the sensor signal value to change.
- When using the pump suction mode, it is best to add a flow sensor or an air pump control according to the product design to avoid negative pressure and physical damage to the sensor that cannot be recovered.
- The design of the gas path should avoid direct gas flow to the front of the sensor. An optional flow cap should be used, while the air is inlet and the air is outlet (normally small in and large out). The inlet and outlet gas is designed to be 90 degrees or straight-through with a barrier type to ensure that the gas can fully contact the Carbon Monoxide sensor.

#### 5. Temperature and humidity effects

- The Carbon Monoxide Gas module has been corrected for temperature compensation through an intelligent algorithm, which is suitable for the detection environment of -40 ~ 55 °C.
- The Carbon Monoxide sensor module must not be used and stored for a long time in a high-temperature and low-humidity environment with a humidity below 10% or a temperature above 55 °C. Failure to do so will result in reduced sensor life. Either failure or test data is invalid.
- The frequent and rapid changes in temperature or humidity will affect the chemical material and cause an unexpected decrease in the sensor life.
- Carbon Monoxide sensors are generally not affected by humidity, but during use, it is necessary to avoid condensation blocking the air inlet holes on the surface of the filter membrane, resulting in the inability of Carbon Monoxide to diffuse into the sensor and no signal output.
- Impact of environmental changes on sensors: Due to the principle and characteristics of electrochemical sensors, environmental changes have varying degrees of influence on the chemical electrolytes inside the sensors. The Carbon Monoxide detection module analyzes the changes in the current data of the sensor in detail through different environmental temperature and humidity effects tests, and combines the temperature and humidity sensor data to perform algorithmic compensation to correct the resulting deviations. Sudden changes in temperature and humidity will cause abnormal fluctuations in the trace data of the sensor, but generally it can fully adapt to the new environment and be stable within 5-10 minutes.

#### 6. Maintain

- The maintenance of the Carbon Monoxide detection module is mainly for accuracy calibration. Generally, the solid polymer Carbon Monoxide sensor does not consume chemical electrolyte, but it can be affected by temperature, humidity, dust, and other gases used in the environment. The sensitivity of the sensor will shift, and the Carbon Monoxide sensor needs to be re-calibrated. The better the use environment, the longer the maintenance cycle and less maintenance workload.
- In case a calibration is needed the user may make sure that clean air is available or the module can be sent back to the factory for recalibration.



## User Guide

### Precautions

1. The main function of the gas sensor is to detect the gas composition and content. Please make sure that the sensor is not getting in touch with any liquid;
2. Different gas sensors have different measurement concentration ranges (ranges), and should not be exposed to over-range/high concentrations for a longer time;
3. The sensor is covered with a waterproof and breathable filter (on the top of the sensor), which should not be damaged, scratched or pulled off;
4. Please make sure that the ventilation (filter) surface of the sensor is not blocked or contaminated. Blockage of the filter may lead to a reduced sensitivity, slow response time, or no response.
5. Please do not exchange the sensors of different gas detection modules, this will cause measurement errors, because all the parameters of each sensor and each circuit board are matched and calibrated, there will be deviations after the exchange;
6. Once the PS1 Carbon Monoxide sensor is unplugged and reinserted into the circuit board, please check that the three electrodes of PS1 correspond to the sockets on the circuit board to avoid irreversible damage to the sensor after reverse insertion;
7. Avoid excessive impact or vibration, such as the shell rupture, reveal the internal structure, the output will not guarantee the effectiveness.

#### DISCLAIMER:

SGX Europe Sp. z o.o. reserves the right to change design features and specifications without prior notification. We do not accept any legal responsibility for customer applications of our sensors. SGX Europe Sp. z o.o. accepts no liability for any consequential losses, injury or damage resulting from the use of this document, the information contained within or from any omissions or errors herein. This document does not constitute an offer for sale and the data contained is for guidance only and may not be taken as warranty. Any use of the given data must be assessed and determined by the user thereof to be in accordance with federal, state and local laws and regulations. All specifications outlined are subject to change without notice.

SGX Europe Sp. z o.o. sensors are designed to operate in a wide range of harsh environments and conditions. However, it is important that exposure to high concentrations of solvent vapours is to be avoided, both during storage, fitting into instruments and operation. When using sensors on printed circuit boards (PCBs), degreasing agents should be used prior to the sensor being fitted. SGX Europe Sp. z o.o. makes every effort to ensure the reliability of its products. Where life safety is a performance requirement of the product, we recommend that all sensors and instruments using these sensors are checked for response to gas before use.

Copyright© 2012-2022 SGX Sensortech All rights reserved.

Trademarks and registered trademarks are the property of their respective owners.

No part of this publication may be reproduced, distributed, or transmitted in any form or by any means, including photocopying, recording, or other electronic or mechanical methods, without the prior written permission of the publisher, except in the case of brief quotations embodied in critical reviews and certain other non-commercial uses permitted by copyright law.

For permission requests or technical support please contact or write to the publisher, addressed "Attention: Permissions Coordinator,".

## Communication Protocol

### General settings

The sensor module uses serial communication. The communication configuration parameters are as follows:

Baud rate	9600
Data bits	8 bits
Stop bit	1 bit
Parity bit	None

Note: The communication is divided into active uploading and Q & A mode. The default mode is Q & A mode after power-on. You can use commands to switch between the two modes. After power-off or switching power consumption mode, the mode is restored.

### Transmission mode switching instruction

**Command 1** Instruction one switches to active upload. The command line format is as follows:

0	1	2	3	4	5	6	7	8
Start bit	Retain	Switch command	Automatic upload	Retain	Retain	Retain	Retain	Proof test value
0 x FF	0 x 01	0 x 78	0 x 40	0 x 00	0 x 00	0 x 00	0 x 00	0 x 47

Note: This format is fixed

**Command 2** Switch to passive upload. The command line format is as follows:

0	1	2	3	4	5	6	7	8
Start bit	Retain	Switch command	Answer	Retain	Retain	Retain	Retain	Proof test value
0 x FF	0 x 01	0 x 78	0 x 41	0 x 00	0 x 00	0 x 00	0 x 00	0 x 46

Note: This format is fixed

### Get module information instruction

**Command 3** Gets sensor type, maximum range, unit, unit decimal places command: 0xD1  
Returned value:

0	1	2	3	4	5	6	7	8
Sensor type	Maximum range high	Maximum range low	Unit	Retain	Retain	Retain	Number of decimal places (bit[4]~bit[7]) Data sign (bit[0]~bit[3])	Parity bit
0 x 23	0 x 00	0 x CB	0 x 02	0 x 00	0 x 00	0 x 00	0 x 00	0 x 35

Note:

Max range = (Max range high << 8) | Max range low

Units: 0x02 (ppm and mg / m<sup>3</sup>) 0x04 (ppb and ug / m<sup>3</sup>)

Signs: 0 (positive number) 1 (negative number)

Decimal places: how many decimal places to read the concentration value, the maximum number of decimal places is 3

## Communication Protocol

**Command 4** Get the sensor type, maximum range, unit, and decimal places command: 0xD7

0	1	2	3	4	5	6	7	8
Command header 1	Command header 2	Sensor type	Maximum range high	Maximum range low	Unit	Number of decimal places (bit[4]~bit[7]) Data sign (bit[0]~bit[3])	Retain	Parity bit
0 x FF	0 x D7	0 x 23	0 x 00	0 x C8	0 x 02	0 x 01	0 x 00	0 x 3B

**Explanation:**

Checksum: 1 ~ 7 bits of data are added to generate an 8-bit data.invert every bit and add 1 to the end

Decimal places bit [4] ~ bit [7]:

(bit[7]<<3) | (bit[6]<<2) | (bit[5]<<1) | bit[4] = decimal places

Data sign (bit[0]~bit[3]):

(bit[3]<<3) | (bit[2]<<2) | (bit[1]<<1) | bit[0] = 0 Negative inhibition

(bit[3]<<3) | (bit[2]<<2) | (bit[1]<<1) | bit[0] = 1 Positive inhibition

Unit :

0x02: unit is mg/m<sup>3</sup> and ppm

0x04: unit is um/m<sup>3</sup> and ppb

0x08: unit is 10g/m<sup>3</sup> and %

**Command 5** The format for actively reading the gas concentration value is as follows :

0	1	2	3	4	5	6	7	8
Start bit	Retain	Command	Retain	Retain	Retain	Retain	Retain	Parity bit
0 x FF	01	0 x 86	0 x 00	0 x 00	0 x 00	0 x 00	0 x 00	0 x 79

Returned value:

0	1	2	3	4	5	6	7	8
Start bit	Command	High gas concentration (ug/m <sup>3</sup> )	Low gas concentration (ug/m <sup>3</sup> )	Full range high	Full range low	High gas concentraton (ppb)	Low gas concentraton (ppb)	Parity bit
0 x FF	0 x 86	0 x 00	0 x 2A	0 x 00	0 x 00	0 x 00	0 x 20	0 x 30

**Description:**

Checksum: 1 ~ 7-bit data is added to generate an 8-bit data.invert every bit and add 1 to the end

Gas concentration value = high gas concentration \*256 + low gas concentration ;

(The high and low concentrations need to be converted from hexadecimal to decimal and then brought into this formula to calculate

## Communication Protocol

**Command 6** Gas concentration value and temperature and humidity combined reading instruction

0	1	2	3	4	5	6	7	8
Start bit	Retain	Command	Retain	Retain	Retain	Retain	Retain	Parity bit
0 x FF	0 x 00	0 x 87	0 x 00	0 x 00	0 x 00	0 x 00	0 x 00	0 x 79

Returned value:

0	1	2	3	4	5	6	7	8	9	10	11	12
Start bit	Command	High gas concentration (ug/m <sup>3</sup> )	Low gas concentration (ug/m <sup>3</sup> )	Full range high	Full range low	High gas concentration (ppb)	Low gas concentration (ppb)	Temperature high	Temperature low	Humidity high	Humidity low	Parity bit
0 x FF	0 x 87	0 x 00	0 x 2A	0 x 03	0 x E8	0 x 00	0 x 20	0 x 09	0 x C4	0 x 13	0 x 88	0 x DC

### Description:

Checksum: 1 ~ 11 bits of data are added to generate an 8-bit data, each bit is inverted, and 1 is added at the end.

Gas concentration value = high gas concentration \* 256 + low gas concentration;

(The high and low concentrations need to be converted from hex) adecimal to decimal and then brought into this formula to calculate

Temperature is signed data with two decimal places (°C-Celsius) Pseudo code calculation formula:

$$T = (\text{float})((\text{int})((0x0A \ll 8) | 0x09)) / 100$$

Humidity is data without signs and two decimal places. The unit is (rh%). Pseudo code calculation formula:

$$Rh = (\text{float})((\text{uint})((0x0A \ll 8) | 0x09)) / 100$$

**Command 7** Get the current temperature and humidity

Returned value:

0	1	2	3
Temperature high 8 bit	Temperature low 8 bit	Humidity high 8 bit	Humidity low 8 bit
0 x 0A	0 x 09	0 x 11	0 x F4

### Description:

Temperature is signed data with two decimal places and the unit is (°C-Celsius)

Pseudo code calculation formula:

$$T = (\text{float})((\text{int})((0x0A \ll 8) | 0x09)) / 100$$

Humidity is data without sign and two decimal places, the unit is (rh%)

Pseudo code calculation formula:

$$Rh = (\text{float})((\text{uint})((0x0A \ll 8) | 0x09)) / 100$$

## Communication Protocol

**Command 8** Get the current temperature and humidity with calibration  
Returned value:

0	1	2	3	4
Temperature high 8 bit	Temperature low 8 bit	Humidity high 8 bit	Humidity low 8 bit	Checksum
0 x 0A	0 x 09	0 x 11	0 x F4	0 x E8

### Description:

Checksum: 0 ~ 3 digits of data are added to generate an 8-bit data. Each bit is inverted, plus 1 at the end  
Temperature is data with a sign and two decimal places. The unit is (°C-Celsius)

Pseudo code calculation formula:

$$T = (\text{float})((\text{int})((0x0A \ll 8) | 0x09)) / 100$$

Humidity is data with no sign and two decimal places in units (rh%).

Pseudo code calculation formula:

$$Rh = (\text{float})((\text{uint})((0x0A \ll 8) | 0x09)) / 100$$

**Command 9** Get the current version number  
Returned value:

0	1	2	3	4	5
0 x 19	0 x 05	0 x 27	0 x 00	0 x 10	0 x 01

### Data in active upload mode

The upload data format is as follows:

0	1	2	3	4	5	6	7	8
Start bit	Command	High gas concentration (ug/m <sup>3</sup> )	Low gas concentration (ug/m <sup>3</sup> )	Full range high	Full range low	High gas concentration (ppb)	Low gas concentration (ppb)	Parity bit
0 x FF	0 x 86	0 x 00	0 x 2A	0 x 00	0 x 00	0 x 00	0 x 20	0 x 30

### Note:

Checksum: Add 1 to 11 digits of data to generate 8 digits of data, invert each bit, add 1 at the end

Gas concentration value = high gas concentration \* 256 + low gas concentration

(The high and low concentrations need to be converted from hexadecimal to decimal and then brought into this formula to calculate)

### Low power switching

#### Enter sleep mode

0	1	2	3	4	5
0 x AF	0 x 53	0 x 6C	0 x 65	0 x 65	0 x 70

Returned value :

0	1
0 x 4F	0 x 4B

## Communication Protocol

### Exit sleep mode

0	1	2	3	4
0x AE	0x 45	0x 78	0x 69	0x 74

Returned value :

0	1
0x 4F	0x 4B

Note: after exiting sleep mode, it takes 5 seconds to recover, no data within 5 seconds

### Enter sleep mode

0	1	2	3	4	5	6
0x A1	0x 53	0x 6C	0x 65	0x 65	0x 70	0x 32

Returned value :

0	1	2	3	4	5	6	7	8
0x FF	0x A1	0x 00	0x 00	0x 00	0x 00	0x 00	0x 00	5F

### Exit sleep mode

0	1	2	3	4	5
0x A2	0x 45	0x 78	0x 69	0x 74	0x 32

Returned value :

0	1	2	3	4	5	6	7	8
0x FF	0x A2	0x 00	0x 00	0x 00	0x 00	0x 00	0x 00	5E

## Communication Protocol

### Turn off the running lights

0	1	2	3	4	5	6	7	8
Start bit	Retain	Command	Retain	Retain	Retain	Retain	Retain	Checksum
0 x FF	0 x 01	0 x 88	0 x 00	0 x 00	0 x 00	0 x 00	0 x 00	0 x 77

Return :

0	1
0 x 4F	0 x 4B

### Turn on the running lights

0	1	2	3	4	5	6	7	8
Start bit	Retain	Command	Retain	Retain	Retain	Retain	Retain	Checksum
0 x FF	0 x 01	0 x 89	0 x 00	0 x 00	0 x 00	0 x 00	0 x 00	0 x 76

Return :

0	1
0 x 4F	0 x 4B

### Query the running light status

0	1	2	3	4	5	6	7	8
Start bit	Retain	Command	Retain	Retain	Retain	Retain	Retain	Checksum
0 x FF	0 x 01	0 x 8A	0 x 00	0 x 00	0 x 00	0 x 00	0 x 00	0 x 75

Return :

0	1	2	3	4	5	6	7	8
Start bit	Command	State value	Retain	Retain	Retain	Retain	Retain	Checksum
0 x FF	0 x 8A	0 x 01	0 x 00	0 x 00	0 x 00	0 x 00	0 x 00	0 x 75

Note: Status value 1 (light on), 0 (light off)