

Peak Emission Wavelength: 1040nm

The MTRS4010C reflective sensor consists of a 1040nm infrared emitter and high sensitivity InGaAs photodiode in the same package. The black molded housing reduces the effect of external ambient light. Custom emitter/detectors are available.

FEATURES

- > High Reliability
- > 5.1 x 3.3mm Surface Mount Package
- > Short Detection Distance Optimum 0.5-1.5mm

APPLICATIONS

- > Card Reader
- > Bar-code Reader
- > Edge Sensing / Money-bill Reader



Absolute Maximum Ratings (Ta=25°C)



ITEMS	SYMBOL	RATINGS	UNIT
Forward Current (LED)	IF	40	mA
Pulse Forward Current (LED)*1	IFP	0.5	A
Reverse Voltage (LED)	VR	5	V
Power Dissipation (LED)	PD	100	mW
Reverse Voltage (PD)	VR (IF=10uA)	3	V
Reverse Current (LED)	IR (VR=5V)	10	uA
Operating Temperature Range	Topr	-20 to +80	°C
Storage Temperature Range	Tstg	-30 to +100	°C

*1: Tw=10µsec, T=10msec.

Electrical & Optical Characteristics (Ta = 25°C)

ITEMS	SYMBOL	CONDITIONS	MIN	TYP	MAX	UNIT
Forward Voltage (LED)	VF	IF=20mA	--	1.25	--	V
Peak Emissions Wavelength (LED)	λ_p	IF=20mA	--	1040	--	nm
Spectral Line Half Width (LED)	$\Delta\lambda$	IF=20mA	--	35	--	nm
Power Output (LED)	PO	IF=20mA	--	2.3	--	mW
Reverse Dark Current (Iceo)	ID	VR=1V	--	2.0	--	uA
Light Current @1300nm	IL	$\lambda=1300\text{nm}$; VR=2V	--	180	--	uA
Shunt Resistance	RSH	VR=10mV	--	2	--	MΩ
Sensitivity Range	V	VR=0V	600	--	1750	nm
Responsivity	R	$\lambda=1550\text{nm}$	--	0.70	--	A/W
Quantum Efficiency	QE	$\lambda=1660\text{nm}$	--	55	--	%
Total Capacitance	CT	VR=0V	--	60	--	pF
Rise/Fall Time (10 to 90%)	Tr, Tf	VR=10V, IF=20mA, RL=1KΩ	--	--	--	uS

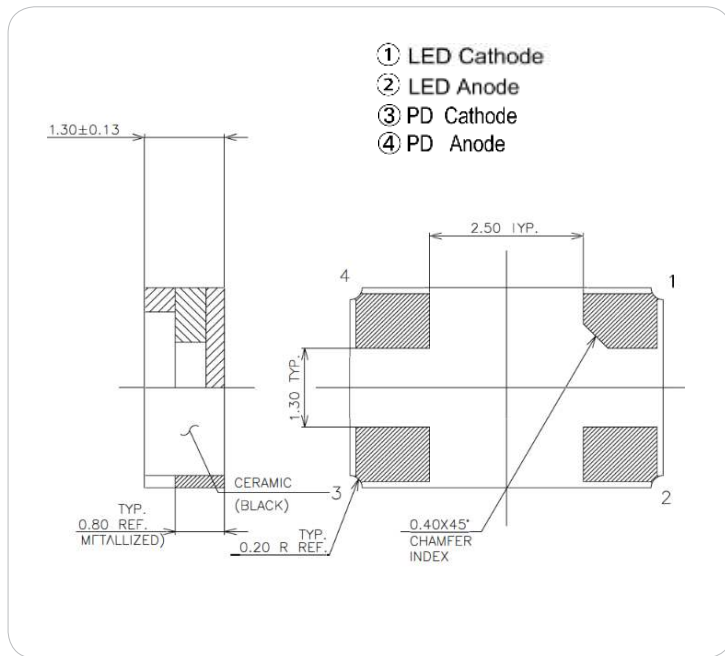
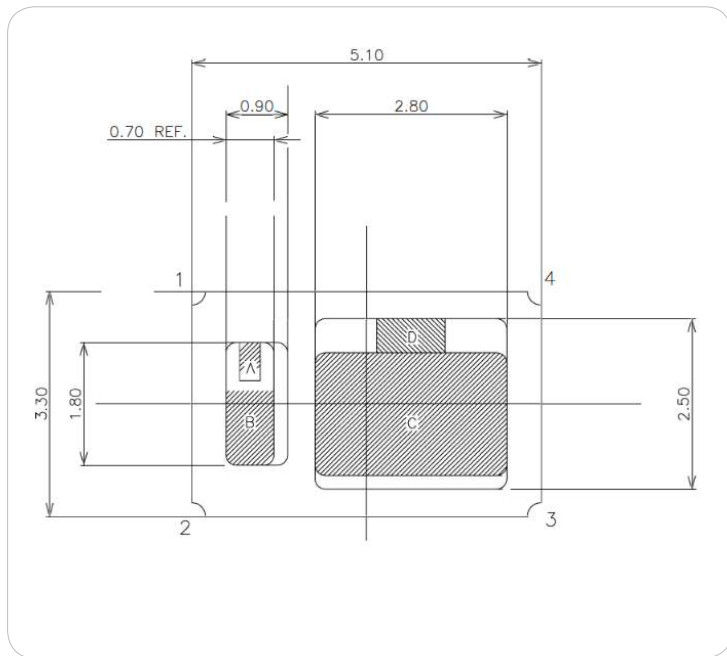

Unit: mm, Tolerance: ±0.2

2019-01-15

