



A Product Line of  
Diodes Incorporated



---

## **PRODUCT SPECIFICATION**

NOMINAL FREQUENCY	100.000000 MHz
PRODUCT TYPE	TYPE HX 2.5x2.0 SEAM SEALED CRYSTAL CLOCK OSCILLATOR
SPEC. NO. ( P/N )	HX21A0007Z
ISSUE DATE	August 3, 2021
VERSION	A

### Diodes Incorporated

No.2, Ziqiang 5th Rd., Zhongli Industrial Park,  
Zhongli Dist., Taoyuan City 32063, Taiwan (R.O.C.)  
TEL: 886-3-451-8888  
FAX: 886-3-461-3865  
<https://www.diodes.com>

- \*Pb-free
- \*RoHS Compliant
- \*HF-Halogen Free
- \*REACH Compliant
- \*MSL: Level 1



# TYPE HX 2.5x2.0 SEAM SEALED CRYSTAL CLOCK OSCILLATOR

## HX21A0007Z

VER. A 3-Aug-21

### ELECTRICAL SPECIFICATIONS

SRe Part Number : HX21A0007Z

Item	Symbol	Specifications	Units	Notes
Nominal Frequency	F <sub>0</sub>	100.000000	MHz	
Frequency Stability	FT	± 25	ppm	**See note
Operating Temperature Range	TR	-40 to +105	°C	
Supply Voltage	V <sub>DD</sub>	+3.3 ± 5%	V	
Logic Type	LT	LVC MOS		
Supply Current, Output Enabled	I <sub>DD</sub> /OE	40	mA	Max
Supply Current, Output Disabled	I <sub>DD</sub> /OD	100	µA	Max
Duty Cycle (Symmetry)	DC/SY	45 / 55	%	Measured 50% of Waveform
Rise / Fall Time	T <sub>R</sub> /T <sub>F</sub>	4	ns	Max. measured 20 / 80% of Waveform
Output Voltage "0" Level	V <sub>OL</sub>	10% V <sub>DD</sub>	V	Max
Output Voltage "1" Level	V <sub>OH</sub>	90% V <sub>DD</sub>	V	Min
Output Load	CL	15	pF	Max
Jitter, Phase	RMS	1	ps	Max. 12KHz ~ 20MHz Frequency Band
Jitter, Accumulated	RMS(1-σ)	4	ps	Max. 20,000 Consecutive Periods
Jitter, Peak to Peak	Pk-Pk	40	ps	Max. 100,000 Random Periods
Start Up Time		10	ms	Max.
Storage Temperature Range		-55 to +125	°C	

※ This product doesn't include harmful substance that stipulated by SONY SS-00259 Level 1 and S-AT2-001 Level 1 standard. RoHS Compliant (Pb - Free).

\*\*Stability includes all combinations of Operating Temperature, Load changes, rated Input (Supply) Voltage changes, Initial Calibration Tolerance (25°C), Aging (1 year at 25°C Average Effective Ambient Temperature), Shock and Vibration.

#### Output Enable / Disable Function

Parameter	Min.	Typ.	Max.	Units	Notes
Input Voltage (Pin1), Output Enable	0.7V <sub>DD</sub>			V	Or Open
Input Voltage (Pin1), Output Disable (low power standby)			0.3V <sub>DD</sub>	V	Output is Hi-Z
Internal Pullup Resistance	30			KΩ	
Output Disable Delay			200	ns	

# TYPE HX 2.5x2.0 SEAM SEALED CRYSTAL CLOCK OSCILLATOR

## HX21A0007Z

VER. A 3-Aug-21

### TEST CIRCUIT

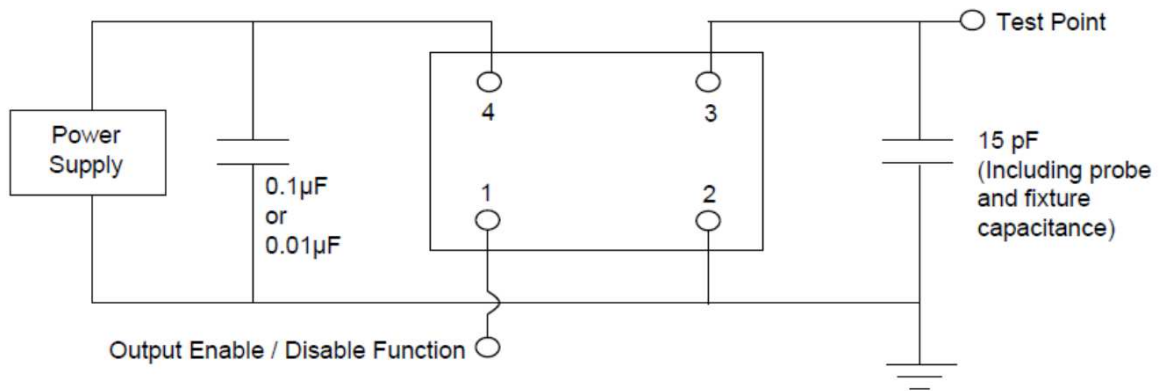

### OUTPUT WAVEFORM

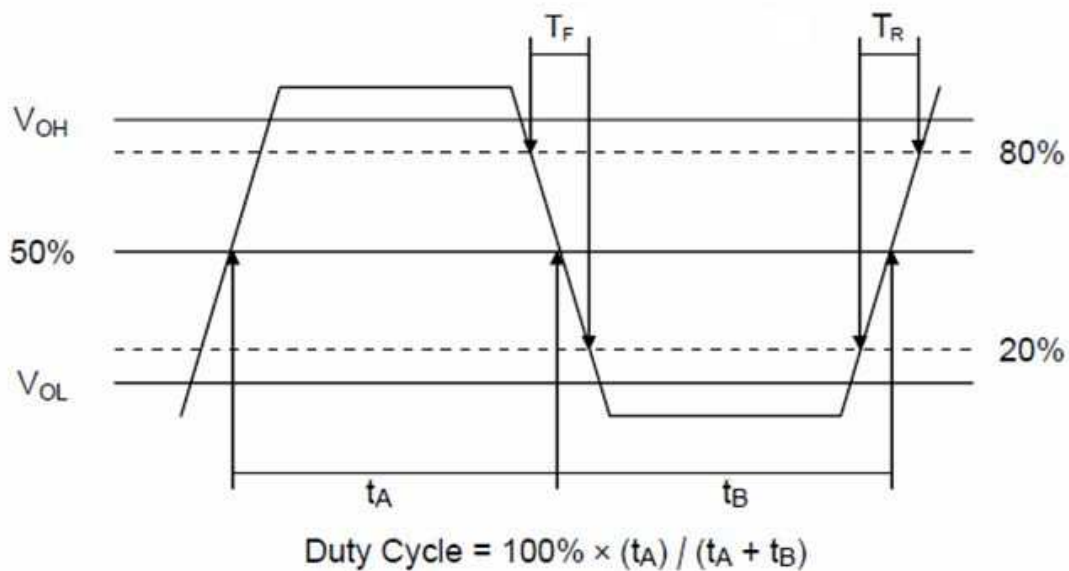

# TYPE HX 2.5x2.0 SEAM SEALED CRYSTAL CLOCK OSCILLATOR

**HX21A0007Z**

VER. A 3-Aug-21

## RELIABILITY SPECIFICATIONS

### ENVIRONMENTAL:

- a) THERMAL SHOCK: MIL-STD-883, Method 1011, Condition A
- b) MOISTURE RESISTANCE: MIL-STD-883, Method 1004
- c) VIBRATION: MIL-STD-883, Method 2007, Condition A
- d) RESISTANCE TO SOLDERING HEAT: J-STD-020D Table 5-2 Pb-free devices (except 2 cycles max)
- e) HAZARDOUS SUBSTANCE: Pb - free and RoHS/Green Compliant.
- f) ESD Testing: JESD22 A114 / JESD22 C101
- g) Latch up Testing: JESD78

### MECHANICAL:

- a) SHOCK: MIL-STD-883, Method 2002, Condition B
- b) SOLDERABILITY: JESD22-B102-D Method 2 (Preconditioning E)
- c) TERMINAL STRENGTH: MIL-STD-883, Method 2004, Test Condition D
- d) GROSS LEAK: MIL-STD-883, Method 1014, Condition C
- e) FINE LEAK: MIL-STD-883, Method 1014, Condition A2,  $R1=2 \times 10^{-8}$  atm cc/s
- f) SOLVENT RESISTANCE: MIL-STD-202, Method 215

## SUGGESTED IR REFLOW PROFILE

\*As per IPC-JEDEC J-STD-020D

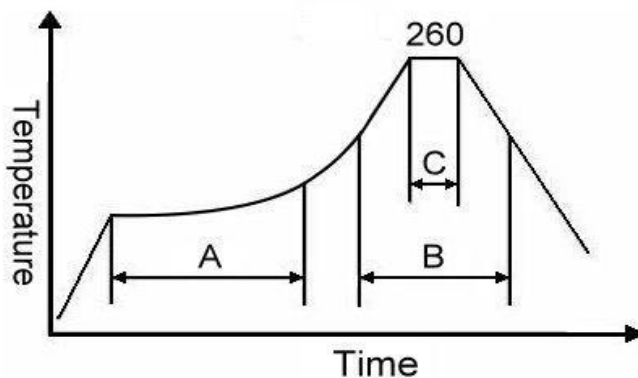

Note:

	Stage	Temperature	Time
A	Preheat	150~200°C	60~120 Sec
B	Primary Heat	217°C	60~150 Sec
C	Peak	260°C	10 Sec

# TYPE HX 2.5x2.0 SEAM SEALED CRYSTAL CLOCK OSCILLATOR

## HX21A0007Z

VER. A 3-Aug-21

### MARKING

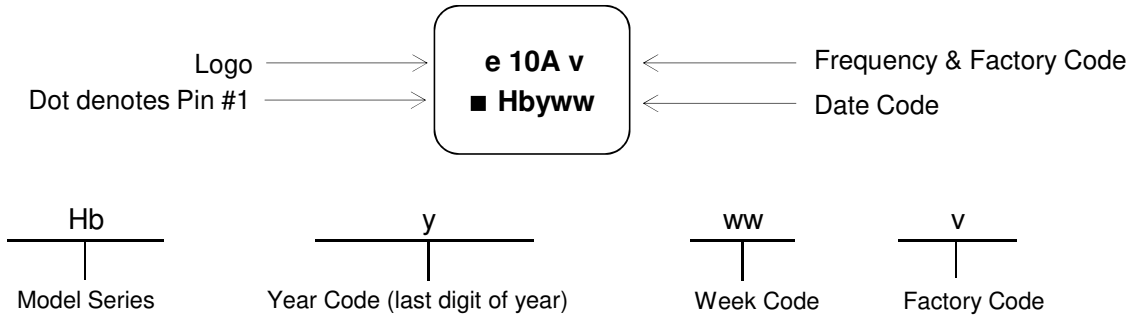

### MECHANICAL DRAWINGS ( Scale:None. Dimensions are in mm.)

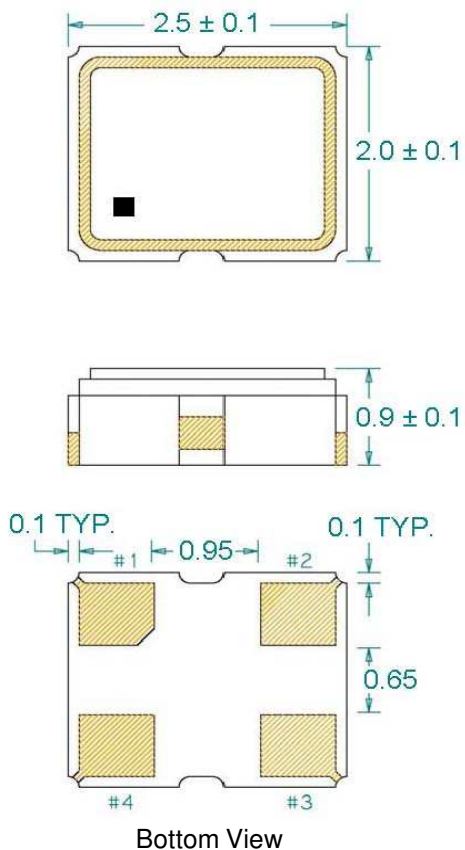

#### Recommended Land Pattern\*

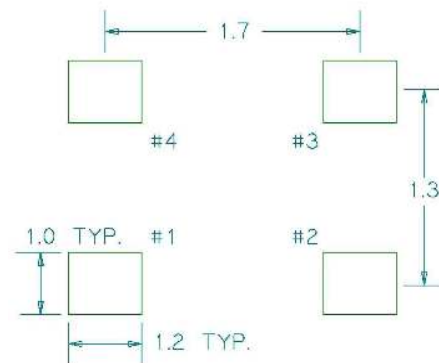

\*External high-frequency power decoupling is recommended. (see test circuit for minimum recommendation). To ensure optimal performance, do not route traces beneath the package.

Pin	Function
1	OE
2	Ground
3	Clock Output
4	V <sub>DD</sub>

# TYPE HX 2.5x2.0 SEAM SEALED CRYSTAL CLOCK OSCILLATOR

## HX21A0007Z

VER. A 3-Aug-21

### TAPE & REEL

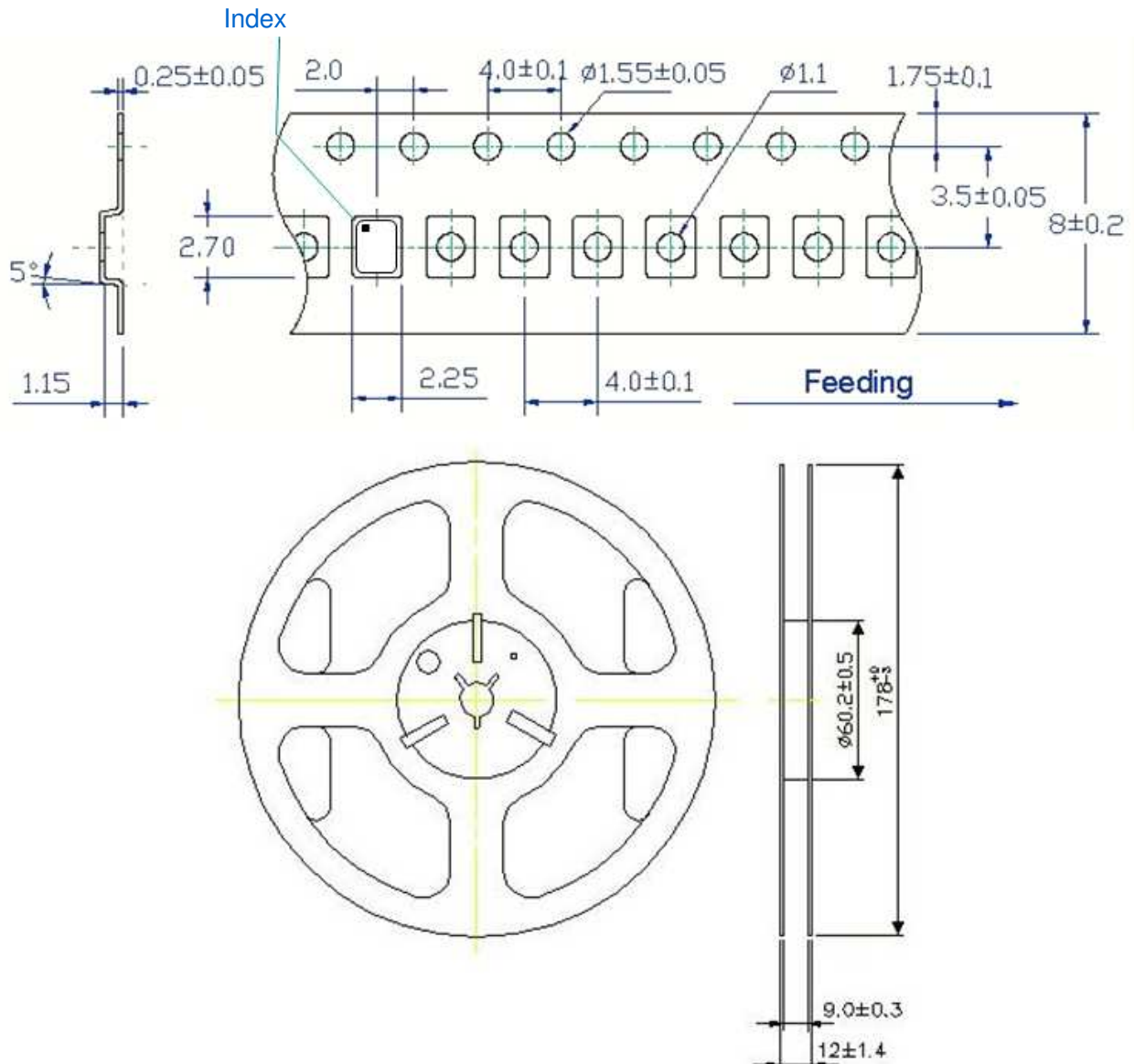

1. 230mm minimum leader which consist of carrier and/or tape followed by a minimum of 160mm of empty carrier tape sealed with cover tape.
2. 160mm minimum trailer of empty carrier tape sealed with cover tape.

# TYPE HX 2.5x2.0 SEAM SEALED CRYSTAL CLOCK OSCILLATOR

## HX21A0007Z

VER. A 3-Aug-21

### PACKING

