

EL SERIES | DC OUTPUT

PANEL MOUNT SOLID STATE RELAYS

Sensata | Crydom EL Series DC output solid state relays come in a compact, 21 x 35 mm housing and offer ratings up to 20 Amps. These compact SSRs come with a pre-installed thermal pad, and are C-UL-US and TUV certified and CE compliant. The EL Series mechanical design includes quick connect terminals and an innovative 90° bent terminals option ideal for applications with limited vertical space.



Features

- Ratings of 5A, 10A and 20A @ 3-100 VDC
- UL Recognized, TUV, CE and RoHS Compliant
- 5, 12 and 24 VDC control input options
- Mosfet Output
- Thermal Pad Included
- Plastic housing with min. 250 CTI rating (PLC2) for demanding applications

Applications

- Battery Management Systems
- Backup Power Supplies
- Valves
- Vending Equipment
- Lighting control
- Medical Equipment

PRODUCT SELECTION

Control Voltage	5A	10A	20A
4-8 VDC	EL100D5-05	EL100D10-05	EL100D20-05
10-14 VDC	EL100D5-12	EL100D10-12	EL100D20-12
21-27 VDC	EL100D5-24	EL100D10-24	EL100D20-24



SPECIFICATIONS

Output ⁽¹⁾⁽³⁾

Description	5A	10A	20A
Operating Voltage [VDC]	3-100	3-100	3-100
Maximum Load Current [Adc] ⁽²⁾	5	10	20
Minimum Load Current [mAdc]	20	20	2.5
Maximum Surge Current Non-Repetitive (10ms) [A]	80	100	100
Maximum Off-State Leakage Current @ Rated Voltage [μ Adc]	100	100	100
Maximum On-State Resistance @ Rated Current (Rds-on) [Ohm]	0.02	0.02	0.013
Maximum On-State Voltage Drop @ Rated Current [VDC]	0.12	0.25	0.27

Input ⁽¹⁾

Description	EL100Dxx-05	EL100Dxx-12	EL100Dxx-24
Control Voltage Range	4-8 VDC	10-14 VDC	21-27 VDC
Minimum Turn-On Voltage	4 VDC	10 VDC	21 VDC
Must Turn-Off Voltage	1 VDC	1 VDC	1 VDC
Minimum Input Current	12 mA	10 mA	9 mA
Maximum Input Current	27 mA	15.5 mA	14 mA
Nominal Input Impedance [Ohms]	300	940	2k
Maximum Turn-On Time [msec]	1	1	1
Maximum Turn-Off Time [μ sec]	300	300	300

General ⁽¹⁾

Description	Parameters
Dielectric Strength, Input to Output	2500 Vrms
Dielectric Strength, Output to Baseplate	2500 Vrms
Ambient Operating Temperature Range	-30 to 80°C
Ambient Storage Temperature Range	-30 to 125°C
Weight (typical)	0.5 oz (14.4 g)
Terminals	3/16" x 0.032" input, 1/4" x 0.032" output QC
SSR Mounting Screw Torque Range	9.0-10.0 lb-in (1.0-1.13 Nm)
Humidity per IEC60068-2-78	95% non-condensing



MECHANICAL SPECIFICATIONS

Tolerances: ± 0.02 in / 0.5 mm
All dimensions are in: inches [millimeters]

Standard Quick Connect terminals

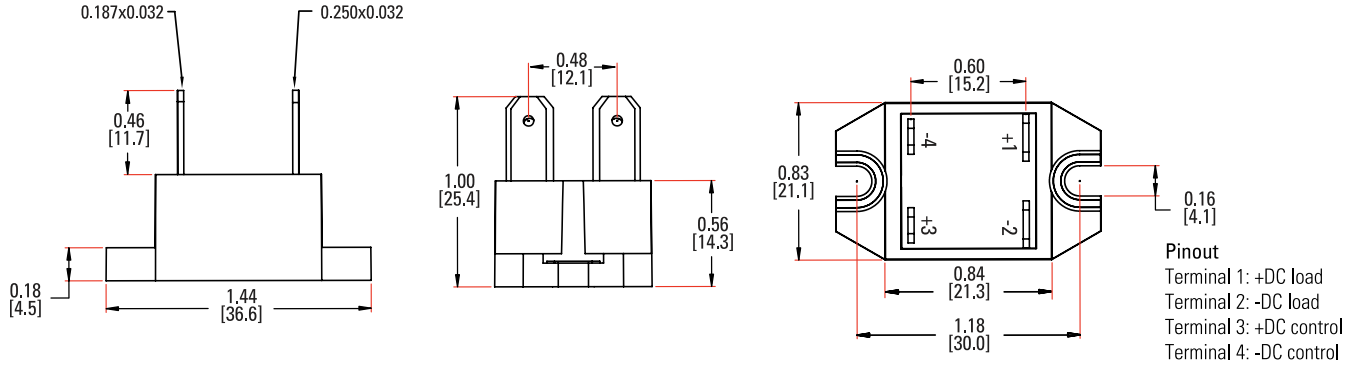

90° bent Quick Connect terminals

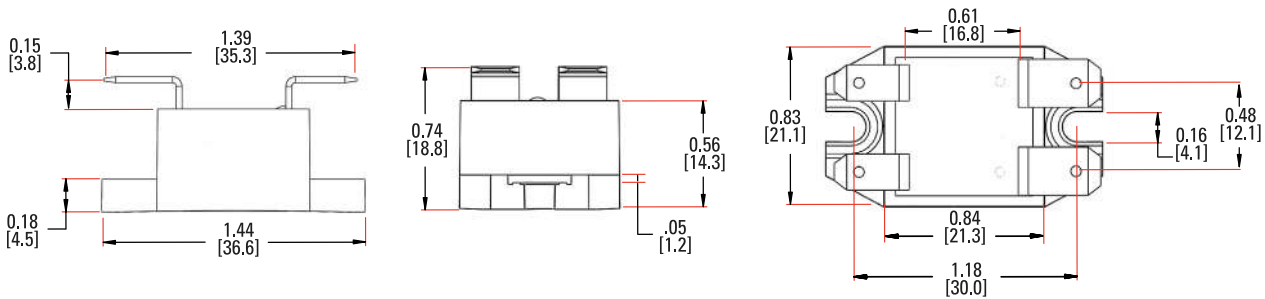

EQUIVALENT CIRCUIT BLOCK DIAGRAM / WIRING DIAGRAMS

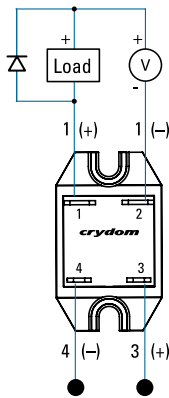
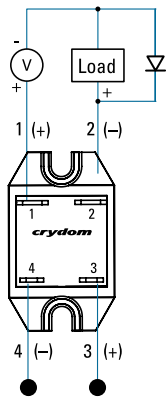
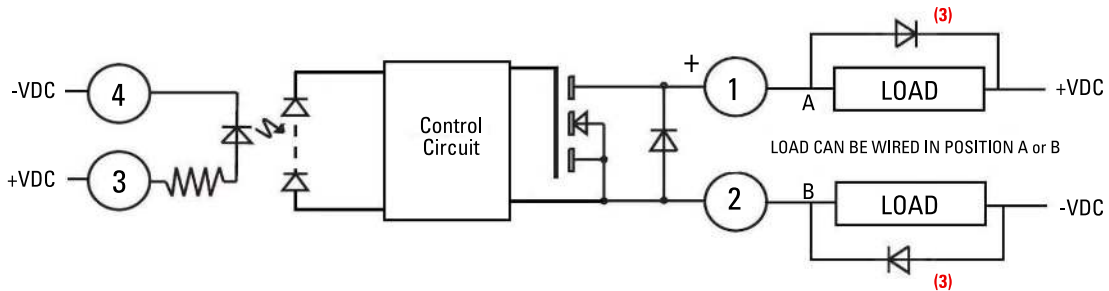



THERMAL DERATE INFORMATION

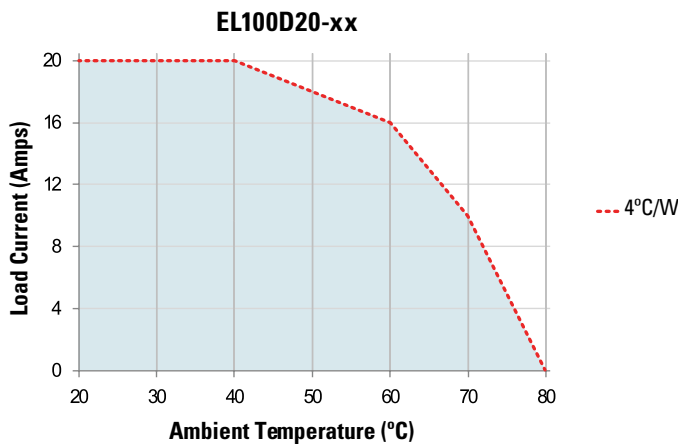
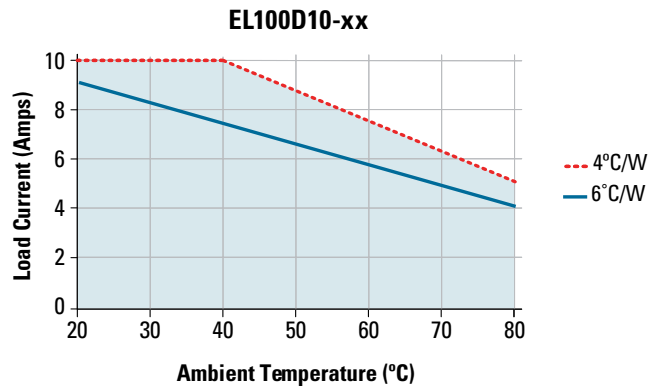
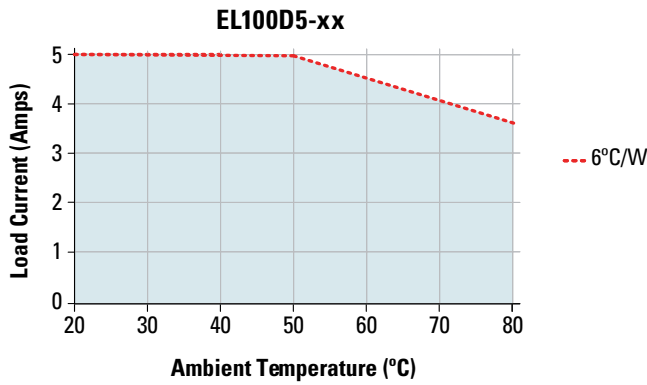

MOUNTING INSTRUCTIONS

Choose one of the two mounting options and follow the instructions

Mounting on Heat Sinks

- Select adequate heat sink. (Please refer to thermal derating curves for the specific model)
- Be sure that thermal pad is pre-installed before installing over the heat sink.
- EL mounting slots have a diameter of 0.16 in (4.0 mm). Two screws are needed (not included) to mount the EL onto heat sink (See fig. 1). recommended screw size is 8-32 (UNC standard) or M4 (metric).
- Before applying full torque tighten down both screws until they contact the baseplate. Then, tighten them to 9.0-10.0 lb-in (1.0-1.13 Nm).
- For optimal thermal performance heat sink fins should be oriented vertically to promote natural convection airflow

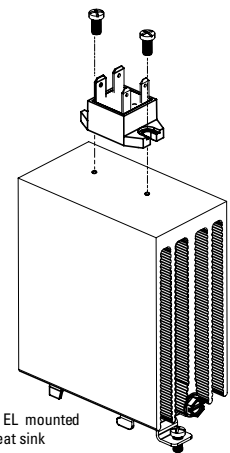

fig. 1 EL mounted on heat sink

Mounting on Panels

- Locate the panel section on which the EL will be mounted. Panel mount surface must provide adequate heat sinking capability, uncoated, clean, flat (0.004 in/in recommended) and preferably aluminum.
- Be sure that thermal pad is pre-installed before install over the heatsink.
- EL mounting slots have a diameter of 0.16 in (4.0 mm). Two screws are needed (not included) to mount the EL onto panel. Choose screw length considering the mounting surface hole depth and that the SSR flange thickness is 0.125 in (3.2 mm).
- Before applying full torque tighten down both screws until they contact the baseplate. Then, tighten them to 10 lb-in (1.13 Nm).

Transient Protection

- An inductive load will produce harmful transient voltage when it is turned off. The more perfect the switch, the larger the transient voltages. The MOSFET output is so nearly ideal switch that the transient voltages produced by seemingly "non-inductive" loads can cause damage if not suppressed. Diodes should be fast recovery type with PIV rated greater than supply voltage. ⁽³⁾



GENERAL NOTES

- (1) All parameters at 25°C unless otherwise specified.
- (2) When mounted to the proper size heat sink (see derating curves)
- (3) Inductive loads should be diode suppressed to prevent damage to the relay



ORDERING OPTIONS

Example : EL100D10-05N

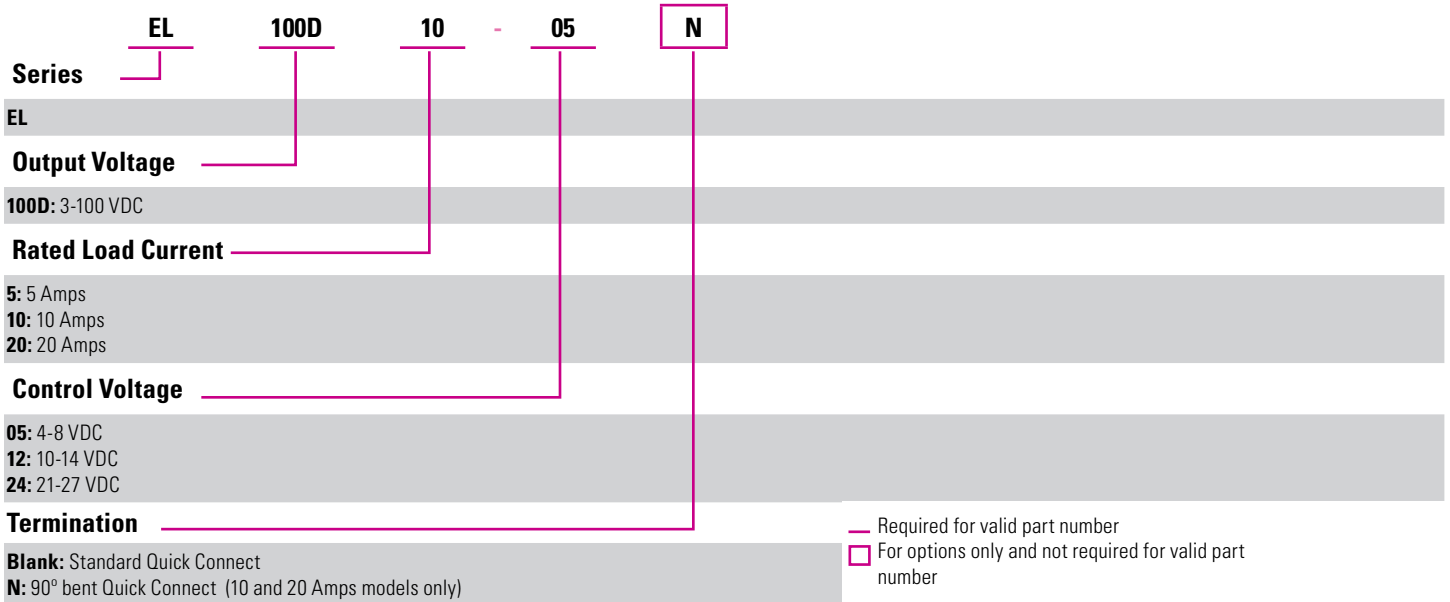

AGENCY APPROVALS & CERTIFICATIONS



Certification in accordance with:

United States Standard for Industrial Control Equipment - UL 508 and
Canadian Standard Association for Industrial Control Equipment – C22.2 No. 14.

TUV SUD according to IEC 60335-1.

Vibration and Shock Resistance:
IEC 61373 : Category 1, Class B.



WARNINGS



RISK OF MATERIAL DAMAGE AND HOT ENCLOSURE

- The product's side panels may be hot, allow the product to cool before touching
- Follow proper mounting instructions including torque values
- Do not allow liquids or foreign objects to enter this product

Failure to follow these instructions can result in serious injury, or equipment damage.



HAZARD OF ELECTRIC SHOCK, EXPLOSION OR ARC FLASH

- Disconnect all power before installing or working with this equipment
- Verify all connections and replace all covers before turning on power

Failure to follow these instructions will result in death or serious injury.

Sensata Technologies, Inc. ("Sensata") data sheets are solely intended to assist designers ("Buyers") who are developing systems that incorporate Sensata products (also referred to herein as "components"). Buyer understands and agrees that Buyer remains responsible for using its independent analysis, valuation, and judgment in designing Buyer's systems and products. Sensata data sheets have been created using standard laboratory conditions and engineering practices. Sensata has not conducted any testing other than that specifically described in the published documentation for a particular data sheet. Sensata may make corrections, enhancements, improvements, and other changes to its data sheets or components without notice.

Buyers are authorized to use Sensata data sheets with the Sensata component(s) identified in each particular data sheet. HOWEVER, NO OTHER LICENSE, EXPRESS OR IMPLIED, BY ESTOPPEL OTHERWISE TO ANY OTHER SENSATA INTELLECTUAL PROPERTY RIGHT, AND NO LICENSE TO ANY THIRD PARTY TECHNOLOGY OR INTELLECTUAL PROPERTY RIGHT, IS GRANTED HEREIN. SENSATA DATA SHEETS ARE PROVIDED "AS IS". SENSATA MAKES NO WARRANTIES OR REPRESENTATIONS WITH REGARD TO THE DATA SHEETS OR USE OF THE DATA SHEETS, EXPRESS, IMPLIED, OR STATUTORY, INCLUDING ACCURACY OR COMPLETENESS. SENSATA DISCLAIMS ANY WARRANTY OF TITLE AND ANY IMPLIED WARRANTIES OF MERCHANTABILITY, FITNESS FOR A PARTICULAR PURPOSE, QUIET ENJOYMENT, QUIET POSSESSION, AND NON-INFRINGEMENT OF ANY THIRD PARTY INTELLECTUAL PROPERTY RIGHTS WITH REGARD TO SENSATA DATA SHEETS OR USE THEREOF.

All products are sold subject to Sensata's terms and conditions of sale supplied at www.sensata.com SENSATA ASSUMES NO LIABILITY FOR APPLICATIONS ASSISTANCE OR THE DESIGN OF BUYERS' PRODUCTS. BUYER ACKNOWLEDGES AND AGREES THAT IT IS SOLELY RESPONSIBLE FOR COMPLIANCE WITH ALL LEGAL, REGULATORY, AND SAFETY-RELATED REQUIREMENTS CONCERNING ITS PRODUCTS, AND ANY USE OF SENSATA COMPONENTS IN ITS APPLICATIONS, NOTWITHSTANDING ANY APPLICATIONS-RELATED INFORMATION OR SUPPORT THAT MAY BE PROVIDED BY SENSATA.

Mailing Address: Sensata Technologies, Inc., 529 Pleasant Street, Attleboro, MA 02703, USA

CONTACT US

Americas

+1 (877) 502 5500 – Option 2
sales.crydom@sensata.com

Europe, Middle East & Africa

+44 (1202) 416170
ssr-info.eu@sensata.com

Asia Pacific

sales.isasia@list.sensata.com
 China +86 (21) 2306 1500
 Japan +81 (45) 277 7117
 Korea +82 (31) 601 2004
 India +91 (80) 67920890
 Rest of Asia +886 (2) 27602006
 ext 2808